

REV	ZONE	EC NO.	DISCRIPTION	DATE
A	ALL	ABU2011-0087	FIRST RELEASE	20110407
B	ALL	ABU2011-0104	DRAWING UPDATE	20110516

NOTE:
 1. MATERIAL :LCP-LDS, VECTRA E840ILDS, 40% MINERAL FILLED LASER DIRECT STRUCTURING GRADE,UL94V-0;
 2.GENERAL TOLERANCE :+/-0.05MM
 3.PRODUCT COMPLANT TO ROHS DIERTIVE 2002/95/EC AND ELV DIRECTIVE2000/53/EC

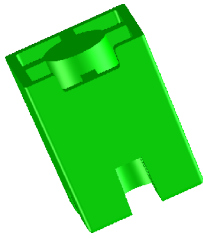

gen1

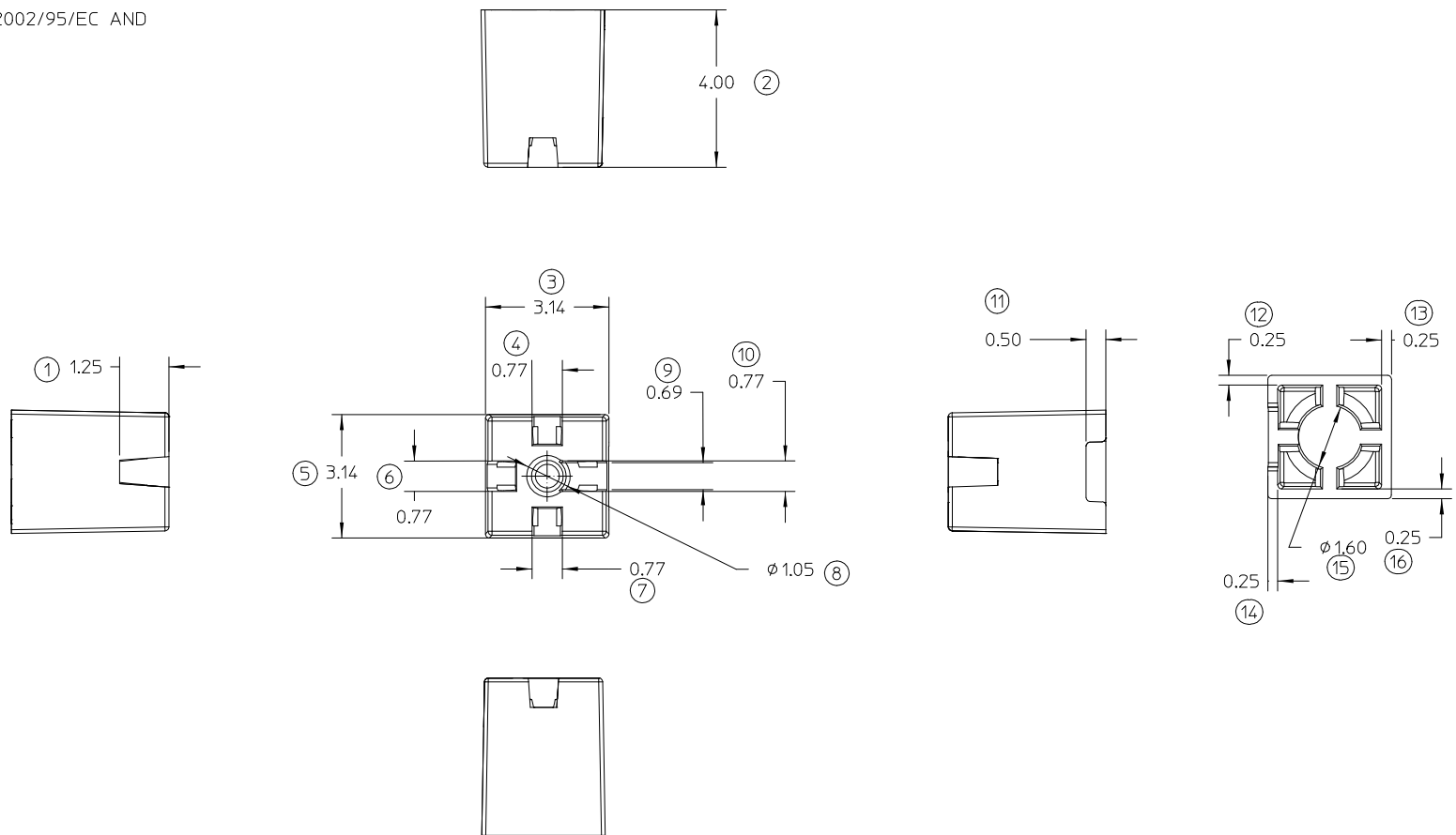

ENTER DESCRIPTION EC NO: DRWN: CHKD: APPR:	QUALITY SYMBOLS F=0 F=0 F=0	GENERAL TOLERANCES (UNLESS SPECIFIED)		DIMENSION STYLE		SCALE 8:1	DESIGN UNITS	THIRD ANGLE PROJECTION
		mm	INCH	DRAWN BY	DATE	TITLE		
		4 PLACES ±	±	COOPRZHOU	20110516	2.4GHZ SMD ON GROND ANTENNA CARRIER		
		3 PLACES ±	±	CHECKED BY	DATE	MOLEX INCORPORATED		
2 PLACES ±	±	ERIC SHI	20110516	DOCUMENT NO.				
1 PLACE ±	±	APPROVED BY	DATE	SD-47948-001				
ANGULAR ± °		DRAFT WHERE APPLICABLE MUST REMAIN WITHIN DIMENSIONS		WELSON TAN 20110516		SHEET NO.		1 OF 3
B		REV		SIZE A3		THIS DRAWING CONTAINS INFORMATION THAT IS PROPRIETARY TO MOLEX INCORPORATED AND SHOULD NOT BE USED WITHOUT WRITTEN PERMISSION		

LDS PATTERN

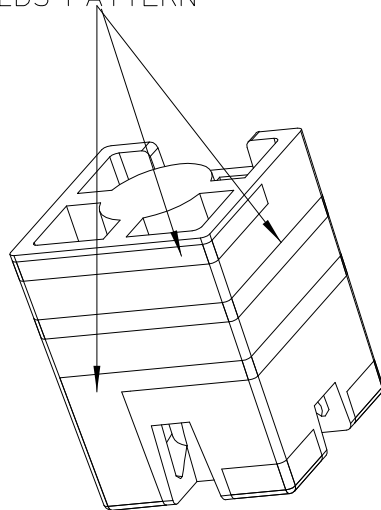

PATTERN FOR SOLDERING

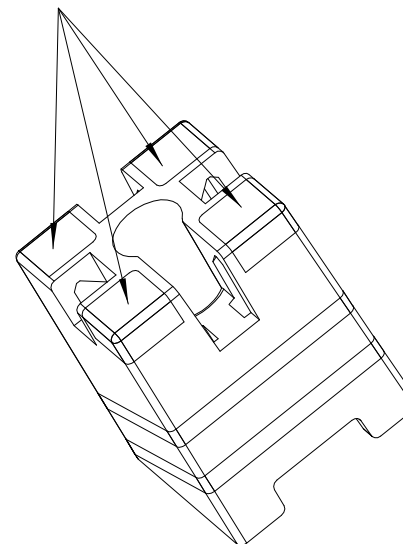

Notes:

1. PLATING SPEC:

- Cu: 12 um MINIMUM;
- MID P Ni: 2um MINIMUM;
- Au : 0.1uM MINIMUM

2. OVER FLOWING OF PATTERN PROFILE AFTER PLATING:0.03uM MAXIMUM.

Table-1

Pos	Material Number	Description	Qty
4	479480004	2.4 GHZ SMG ON GROUD (AFTER MOLDING)	1
3	479480003	2.4 GHZ SMG ON GROUD (AFTER LDS)	1
2	479480002	2.4 GHZ SMG ON GROUD (AFTER PLATING)	1
1	479480001	2.4 GHZ SMG ON GROUD (After RF test)	1

ENTER DESCRIPTION	REV	DESCRIPTION	QUALITY SYMBOLS	GENERAL TOLERANCES (UNLESS SPECIFIED)		DIMENSION STYLE MM ONLY		SCALE 10:1	DESIGN UNITS METRIC	THIRD ANGLE PROJECTION	
			▽=0	4 PLACES ±	±	DRAWN BY COOPERZHOU	DATE 20110516	TITLE 2.4 GHZ SMG ON GROUD ANTENNA PATTERN			
			▽C=0	3 PLACES ±	±	CHECKED BY ERIC SHI	DATE 20110516				
			◇=0	2 PLACES ±	±	APPROVED BY WESTON TAN		DATE 20110516	molex MOLEX INCORPORATED		
			◇=1	1 PLACE ±	±	MATERIAL NO. See Table-1		DOCUMENT NO. SD-47948-001	SHEET NO. 2 OF 3		
			DRAFT WHERE APPLICABLE MUST REMAIN WITHIN DIMENSIONS		THIS DRAWING CONTAINS INFORMATION THAT IS PROPRIETARY TO MOLEX INCORPORATED AND SHOULD NOT BE USED WITHOUT WRITTEN PERMISSION						

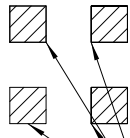
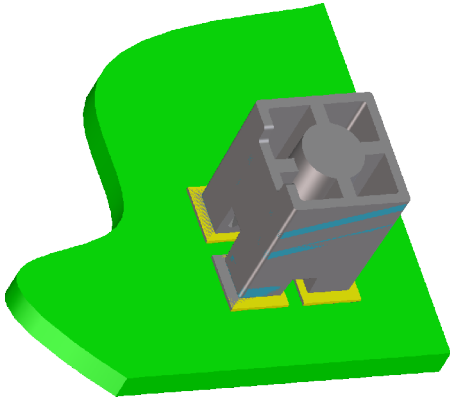

THE CONTACT PAD ON PRODUCT FOR SOLDERING

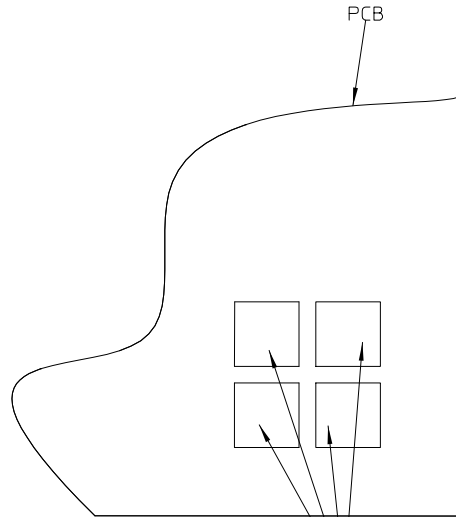

THE FOOTPRINT ON PWB FOR SOLDERING

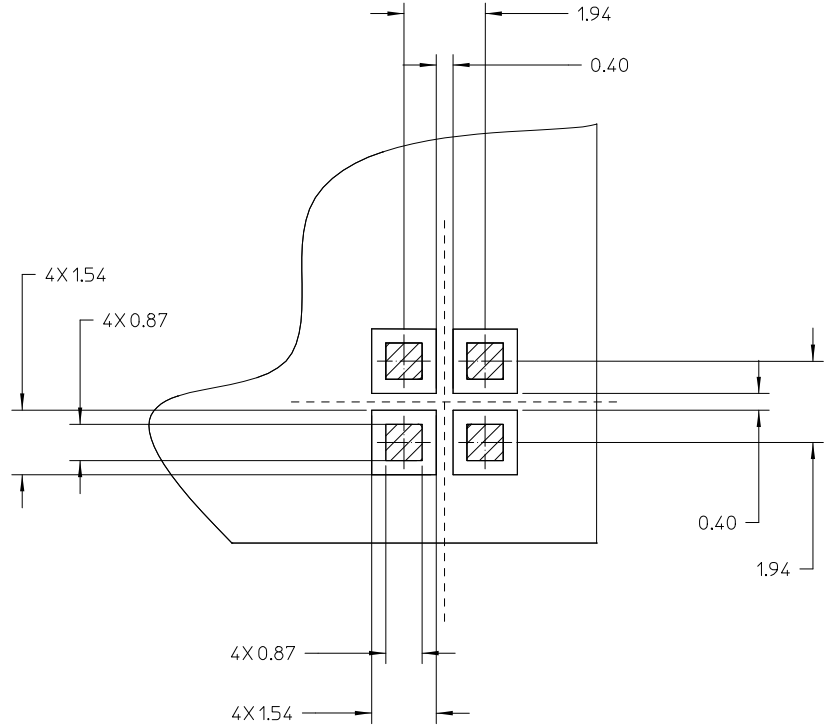

RECOMENED PWB PATTERN LAYOUT

ENTER DESCRIPTION EC NO: DRWN: CHKD: APPR:	DESCRIPTION REV	QUALITY SYMBOLS $F=0$ $F=0$ $F=0$	GENERAL TOLERANCES (UNLESS SPECIFIED)		DIMENSION STYLE		SCALE 8:1	DESIGN UNITS	THIRD ANGLE PROJECTION
		4 PLACES ± mm INCH 3 PLACES ± mm INCH 2 PLACES ± mm INCH 1 PLACE ± mm INCH	± mm INCH ± mm INCH ± mm INCH ± mm INCH	DRAWN BY COOPRZHOU 20110516 CHECKED BY ERIC SHI 20110516 APPROVED BY WELSON IAN 20110516	DATE DATE DATE	TITLE FOOTPRINT FOR 2.4 SMD ON GROND ANTENNA			
		ANGULAR ± °		MATERIAL NO. SEE SHIFT 2		MOLEX INCORPORATED DOCUMENT NO. SD-47948-001		SHEET NO. 3 OF 3	
		DRAFT WHERE APPLICABLE MUST REMAIN WITHIN DIMENSIONS		SIZE A3		THIS DRAWING CONTAINS INFORMATION THAT IS PROPRIETARY TO MOLEX INCORPORATED AND SHOULD NOT BE USED WITHOUT WRITTEN PERMISSION			