



Is Now Part of



ON Semiconductor®

To learn more about ON Semiconductor, please visit our website at
www.onsemi.com

Please note: As part of the Fairchild Semiconductor integration, some of the Fairchild orderable part numbers will need to change in order to meet ON Semiconductor's system requirements. Since the ON Semiconductor product management systems do not have the ability to manage part nomenclature that utilizes an underscore (_), the underscore (_) in the Fairchild part numbers will be changed to a dash (-). This document may contain device numbers with an underscore (_). Please check the ON Semiconductor website to verify the updated device numbers. The most current and up-to-date ordering information can be found at www.onsemi.com. Please email any questions regarding the system integration to Fairchild_questions@onsemi.com.

ON Semiconductor and the ON Semiconductor logo are trademarks of Semiconductor Components Industries, LLC dba ON Semiconductor or its subsidiaries in the United States and/or other countries. ON Semiconductor owns the rights to a number of patents, trademarks, copyrights, trade secrets, and other intellectual property. A listing of ON Semiconductor's product/patent coverage may be accessed at www.onsemi.com/site/pdf/Patent-Marking.pdf. ON Semiconductor reserves the right to make changes without further notice to any products herein. ON Semiconductor makes no warranty, representation or guarantee regarding the suitability of its products for any particular purpose, nor does ON Semiconductor assume any liability arising out of the application or use of any product or circuit, and specifically disclaims any and all liability, including without limitation special, consequential or incidental damages. Buyer is responsible for its products and applications using ON Semiconductor products, including compliance with all laws, regulations and safety requirements or standards, regardless of any support or applications information provided by ON Semiconductor. "Typical" parameters which may be provided in ON Semiconductor data sheets and/or specifications can and do vary in different applications and actual performance may vary over time. All operating parameters, including "Typicals" must be validated for each customer application by customer's technical experts. ON Semiconductor does not convey any license under its patent rights nor the rights of others. ON Semiconductor products are not designed, intended, or authorized for use as a critical component in life support systems or any FDA Class 3 medical devices or medical devices with a same or similar classification in a foreign jurisdiction or any devices intended for implantation in the human body. Should Buyer purchase or use ON Semiconductor products for any such unintended or unauthorized application, Buyer shall indemnify and hold ON Semiconductor and its officers, employees, subsidiaries, affiliates, and distributors harmless against all claims, costs, damages, and expenses, and reasonable attorney fees arising out of, directly or indirectly, any claim of personal injury or death associated with such unintended or unauthorized use, even if such claim alleges that ON Semiconductor was negligent regarding the design or manufacture of the part. ON Semiconductor is an Equal Opportunity/Affirmative Action Employer. This literature is subject to all applicable copyright laws and is not for resale in any manner.



December 2014

FGA40T65SHD

650 V, 40 A Field Stop Trench IGBT

Features

- Maximum Junction Temperature : $T_J = 175^\circ\text{C}$
- Positive Temperature Co-efficient for Easy Parallel Operating
- High Current Capability
- Low Saturation Voltage: $V_{CE(sat)} = 1.6\text{ V(Typ.) @ } I_C = 40\text{ A}$
- 100% of the Parts Tested for $I_{LM}(1)$
- High Input Impedance
- Fast Switching
- Tighten Parameter Distribution
- RoHS Compliant

General Description

Using novel field stop IGBT technology, Fairchild's new series of field stop 3rd generation IGBTs offer the optimum performance for solar inverter, UPS, welder, telecom, ESS and PFC applications where low conduction and switching losses are essential.

Applications

- Solar Inverter, UPS, Welder, Telecom, ESS, PFC

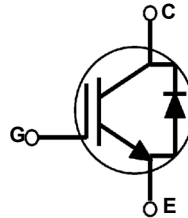
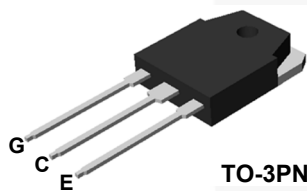

Absolute Maximum Ratings $T_C = 25^\circ\text{C}$ unless otherwise noted

| Symbol | Description | FGA40T65SHD | Unit |
|-------------|---|-------------|------------------|
| V_{CES} | Collector to Emitter Voltage | 650 | V |
| V_{GES} | Gate to Emitter Voltage | ± 20 | A |
| | Transient Gate to Emitter Voltage | ± 30 | A |
| I_C | Collector Current @ $T_C = 25^\circ\text{C}$ | 80 | A |
| | Collector Current @ $T_C = 100^\circ\text{C}$ | 40 | A |
| $I_{LM}(1)$ | Pulsed Collector Current @ $T_C = 25^\circ\text{C}$ | 120 | A |
| $I_{CM}(2)$ | Pulsed Collector Current | 120 | A |
| I_F | Diode Forward Current @ $T_C = 25^\circ\text{C}$ | 40 | A |
| | Diode Forward Current @ $T_C = 100^\circ\text{C}$ | 20 | A |
| $I_{FM}(2)$ | Pulsed Diode Maximum Forward Current | 120 | A |
| P_D | Maximum Power Dissipation @ $T_C = 25^\circ\text{C}$ | 268 | W |
| | Maximum Power Dissipation @ $T_C = 100^\circ\text{C}$ | 134 | W |
| T_J | Operating Junction Temperature | -55 to +175 | $^\circ\text{C}$ |
| T_{stg} | Storage Temperature Range | -55 to +175 | $^\circ\text{C}$ |
| T_L | Maximum Lead Temp. for soldering Purposes, 1/8" from case for 5 seconds | 300 | $^\circ\text{C}$ |

Notes:

1. $V_{CC} = 400\text{ V}$, $V_{GE} = 15\text{ V}$, $I_C = 120\text{ A}$, $R_G = 30\ \Omega$, Inductive Load
2. Repetitive rating: Pulse width limited by max. junction temperature

FGA40T65SHD 650 V, 40 A Field Stop Trench IGBT

Thermal Characteristics

| Symbol | Parameter | FGA40T65SHD | Unit |
|-------------------------|---|-------------|-----------------------------|
| $R_{\theta JC}$ (IGBT) | Thermal Resistance, Junction to Case, Max. | 0.56 | $^{\circ}\text{C}/\text{W}$ |
| $R_{\theta JC}$ (Diode) | Thermal Resistance, Junction to Case, Max. | 1.71 | $^{\circ}\text{C}/\text{W}$ |
| $R_{\theta JA}$ | Thermal Resistance, Junction to Ambient, Max. | 40 | $^{\circ}\text{C}/\text{W}$ |

Package Marking and Ordering Information

| Part Number | Top Mark | Package | Packing Method | Reel Size | Tape Width | Quantity |
|-------------|-------------|---------|----------------|-----------|------------|----------|
| FGA40T65SHD | FGA40T65SHD | TO-3PN | Tube | - | - | 30 |

Electrical Characteristics of the IGBT $T_C = 25^{\circ}\text{C}$ unless otherwise noted

| Symbol | Parameter | Test Conditions | Min. | Typ. | Max. | Unit |
|----------------------------------|--|--|------|------|-----------|-----------------------------|
| Off Characteristics | | | | | | |
| BV_{CES} | Collector to Emitter Breakdown Voltage | $V_{GE} = 0\text{V}, I_C = 1\text{mA}$ | 650 | - | - | V |
| $\Delta BV_{CES} / \Delta T_J$ | Temperature Coefficient of Breakdown Voltage | $I_C = 1\text{mA}$, Reference to 25°C | - | 0.6 | - | $\text{V}/^{\circ}\text{C}$ |
| I_{CES} | Collector Cut-Off Current | $V_{CE} = V_{CES}, V_{GE} = 0\text{V}$ | - | - | 250 | μA |
| I_{GES} | G-E Leakage Current | $V_{GE} = V_{GES}, V_{CE} = 0\text{V}$ | - | - | ± 400 | nA |
| On Characteristics | | | | | | |
| $V_{GE(th)}$ | G-E Threshold Voltage | $I_C = 40\text{mA}, V_{CE} = V_{GE}$ | 3.5 | 5.5 | 7.5 | V |
| $V_{CE(sat)}$ | Collector to Emitter Saturation Voltage | $I_C = 40\text{A}, V_{GE} = 15\text{V}$ | - | 1.6 | 2.1 | V |
| | | $I_C = 40\text{A}, V_{GE} = 15\text{V}, T_C = 175^{\circ}\text{C}$ | - | 2.14 | - | V |
| Dynamic Characteristics | | | | | | |
| C_{ies} | Input Capacitance | $V_{CE} = 30\text{V}, V_{GE} = 0\text{V}, f = 1\text{MHz}$ | - | 1995 | - | pF |
| C_{oes} | Output Capacitance | | - | 70 | - | pF |
| C_{res} | Reverse Transfer Capacitance | | - | 23 | - | pF |
| Switching Characteristics | | | | | | |
| $t_{d(on)}$ | Turn-On Delay Time | $V_{CC} = 400\text{V}, I_C = 40\text{A}, R_G = 6\Omega, V_{GE} = 15\text{V}, \text{Inductive Load}, T_C = 25^{\circ}\text{C}$ | - | 19.2 | - | ns |
| t_r | Rise Time | | - | 34.4 | - | ns |
| $t_{d(off)}$ | Turn-Off Delay Time | | - | 65.6 | - | ns |
| t_f | Fall Time | | - | 9.6 | - | ns |
| E_{on} | Turn-On Switching Loss | | - | 1010 | - | μJ |
| E_{off} | Turn-Off Switching Loss | | - | 297 | - | μJ |
| E_{ts} | Total Switching Loss | | - | 1307 | - | μJ |
| $t_{d(on)}$ | Turn-On Delay Time | $V_{CC} = 400\text{V}, I_C = 40\text{A}, R_G = 6\Omega, V_{GE} = 15\text{V}, \text{Inductive Load}, T_C = 175^{\circ}\text{C}$ | - | 18.4 | - | ns |
| t_r | Rise Time | | - | 32.8 | - | ns |
| $t_{d(off)}$ | Turn-Off Delay Time | | - | 71.2 | - | ns |
| t_f | Fall Time | | - | 14.4 | - | ns |
| E_{on} | Turn-On Switching Loss | | - | 1390 | - | μJ |
| E_{off} | Turn-Off Switching Loss | | - | 541 | - | μJ |
| E_{ts} | Total Switching Loss | | - | 1931 | - | μJ |

Electrical Characteristics of the IGBT (Continued)

| Symbol | Parameter | Test Conditions | Min. | Typ. | Max | Unit |
|----------|--------------------------|---|------|------|-----|------|
| Q_g | Total Gate Charge | $V_{CE} = 400\text{ V}$, $I_C = 40\text{ A}$, $V_{GE} = 15\text{ V}$ | - | 72.2 | - | nC |
| Q_{ge} | Gate to Emitter Charge | | - | 13.5 | - | nC |
| Q_{gc} | Gate to Collector Charge | | - | 28.5 | - | nC |

Electrical Characteristics of the Diode $T_C = 25^\circ\text{C}$ unless otherwise noted

| Symbol | Parameter | Test Conditions | Min. | Typ. | Max | Unit | |
|-----------|-------------------------------|--|---------------------------|------|------|------|---------------|
| V_{FM} | Diode Forward Voltage | $I_F = 20\text{ A}$ | $T_C = 25^\circ\text{C}$ | - | 2.2 | 2.8 | V |
| | | | $T_C = 175^\circ\text{C}$ | - | 1.94 | - | |
| E_{rec} | Reverse Recovery Energy | $I_F = 20\text{ A}$, $dI_F/dt = 200\text{ A}/\mu\text{s}$ | $T_C = 175^\circ\text{C}$ | - | 50 | - | μJ |
| t_{rr} | Diode Reverse Recovery Time | | $T_C = 25^\circ\text{C}$ | - | 31.8 | - | ns |
| | | | $T_C = 175^\circ\text{C}$ | - | 192 | - | |
| Q_{rr} | Diode Reverse Recovery Charge | | $T_C = 25^\circ\text{C}$ | - | 50.6 | - | nC |
| | | $T_C = 175^\circ\text{C}$ | - | 699 | - | | |

Typical Performance Characteristics

Figure 1. Typical Output Characteristics

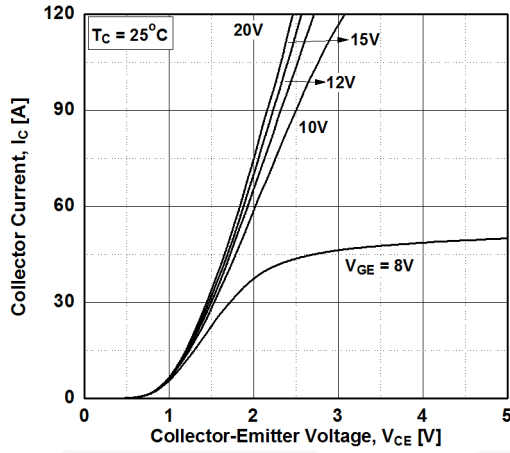

Figure 2. Typical Output Characteristics

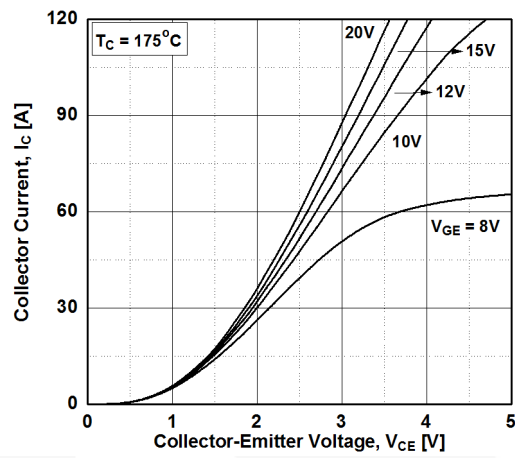

Figure 3. Typical Saturation Voltage Characteristics

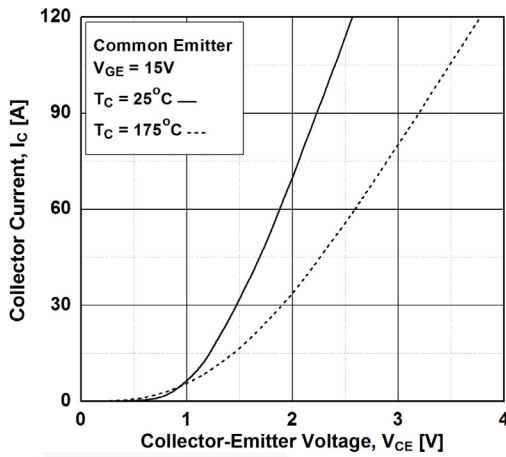

Figure 4. Saturation Voltage vs. Case Temperature at Variant Current Level

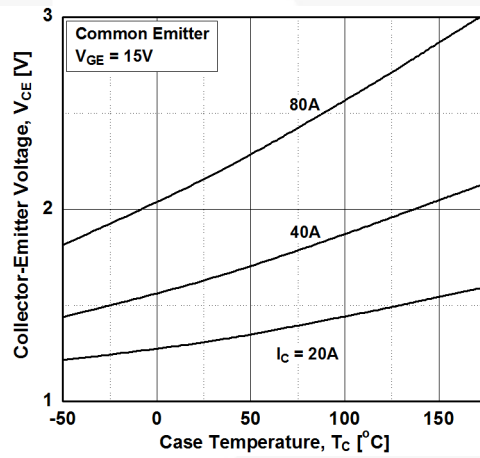

Figure 5. Saturation Voltage vs. Vge

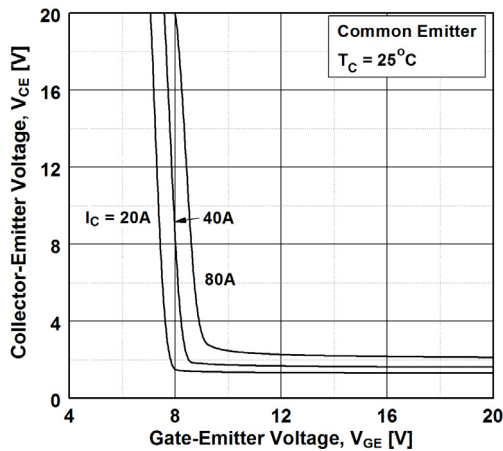
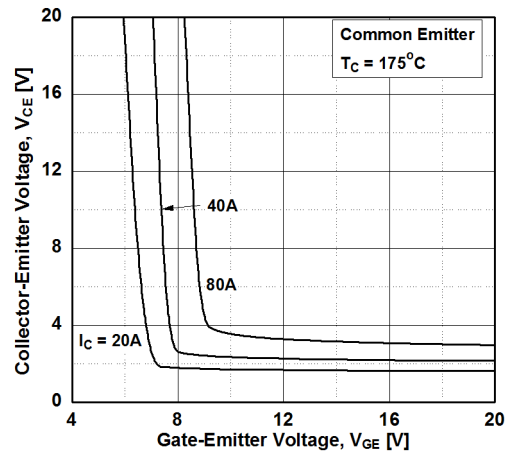

Figure 6. Saturation Voltage vs. Vge



Typical Performance Characteristics

Figure 7. Capacitance Characteristics

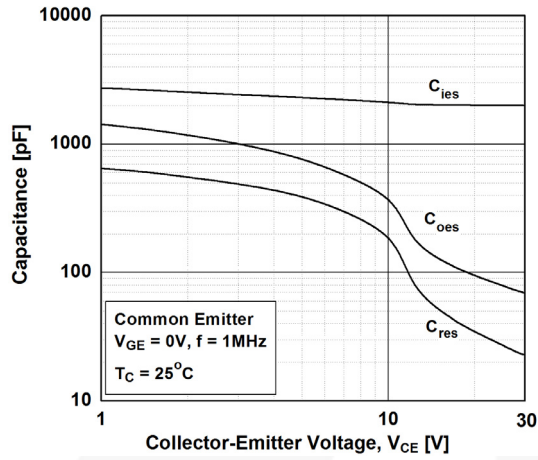

Figure 8. Gate charge Characteristics

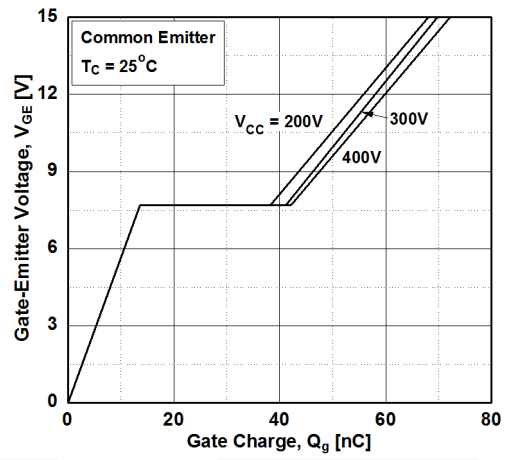

Figure 9. Turn-on Characteristics vs. Gate Resistance

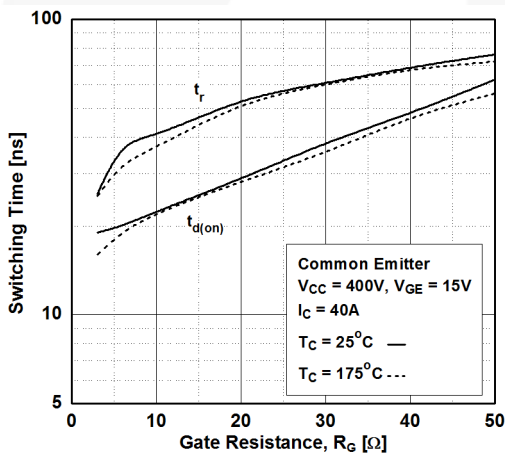

Figure 10. Turn-off Characteristics vs. Gate Resistance

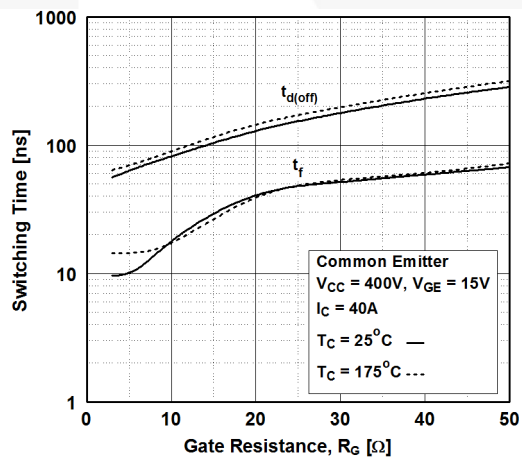

Figure 11. Switching Loss vs. Gate Resistance

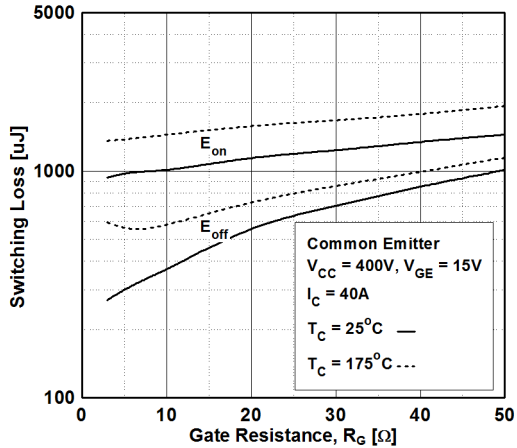
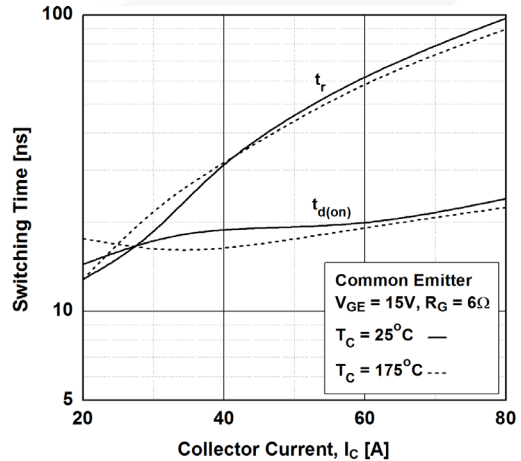

Figure 12. Turn-on Characteristics vs. Collector Current



Typical Performance Characteristics

Figure 13. Turn-off Characteristics vs. Collector Current

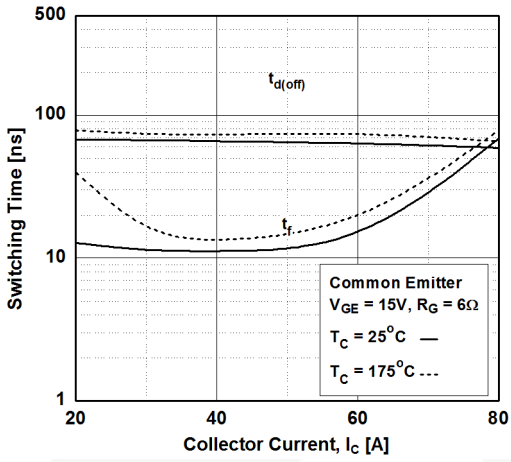

Figure 14. Switching Loss vs. Collector Current

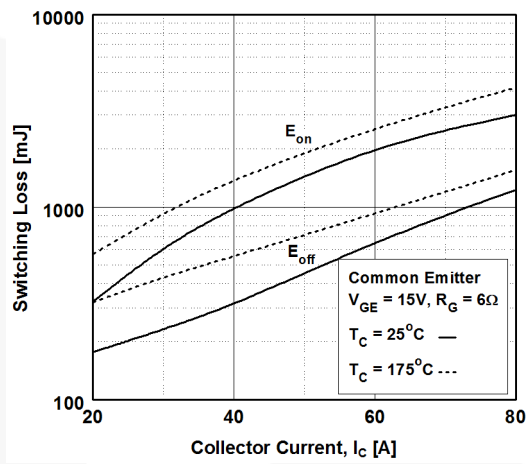

Figure 15. Load Current Vs. Frequency

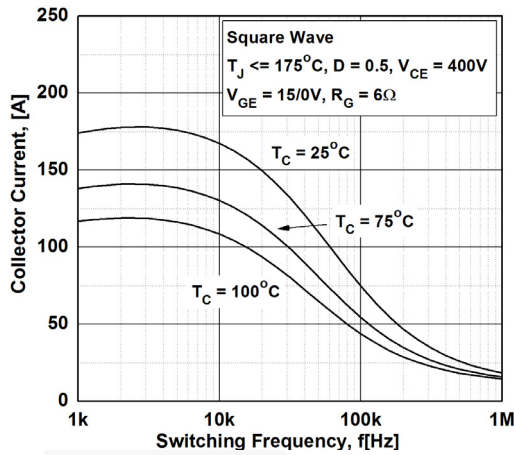

Figure 16. SOA Characteristics

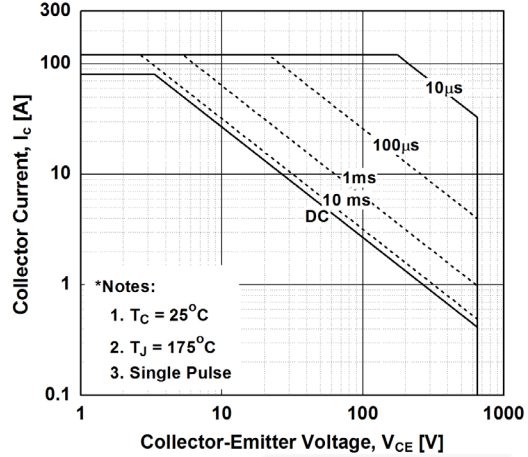

Figure 17. Forward Characteristics

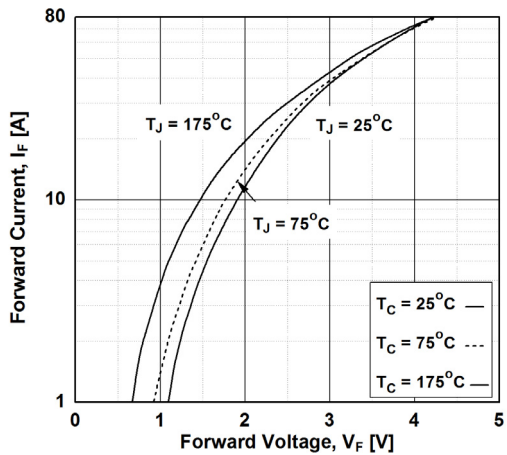
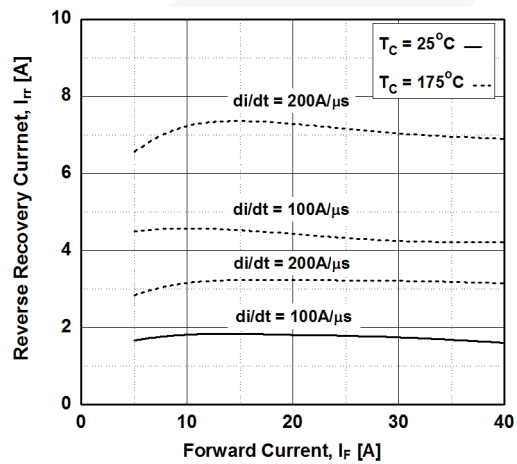

Figure 18. Reverse Recovery Current



Typical Performance Characteristics

Figure 19. Reverse Recovery Time

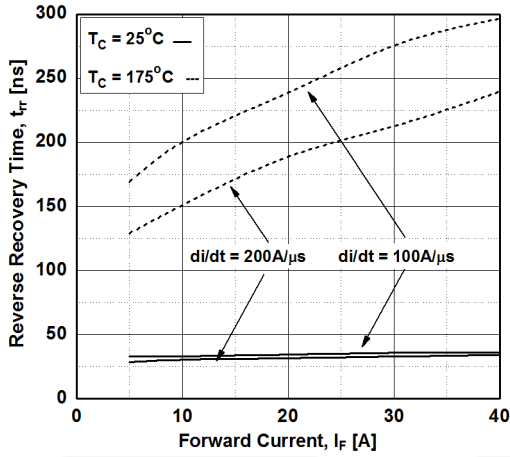

Figure 20. Stored Charge

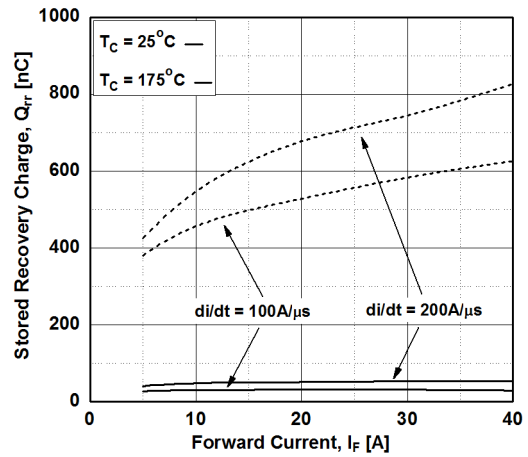

Figure 21. Transient Thermal Impedance of IGBT

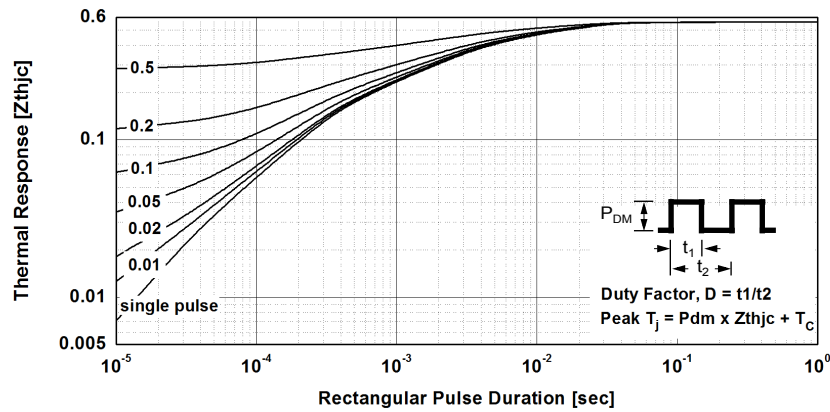
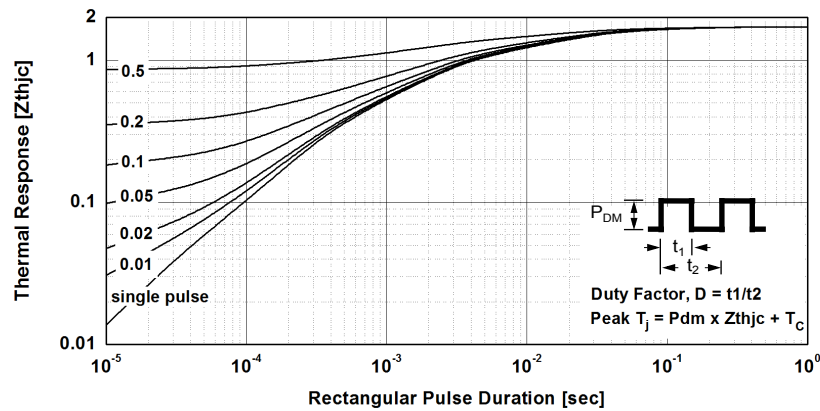
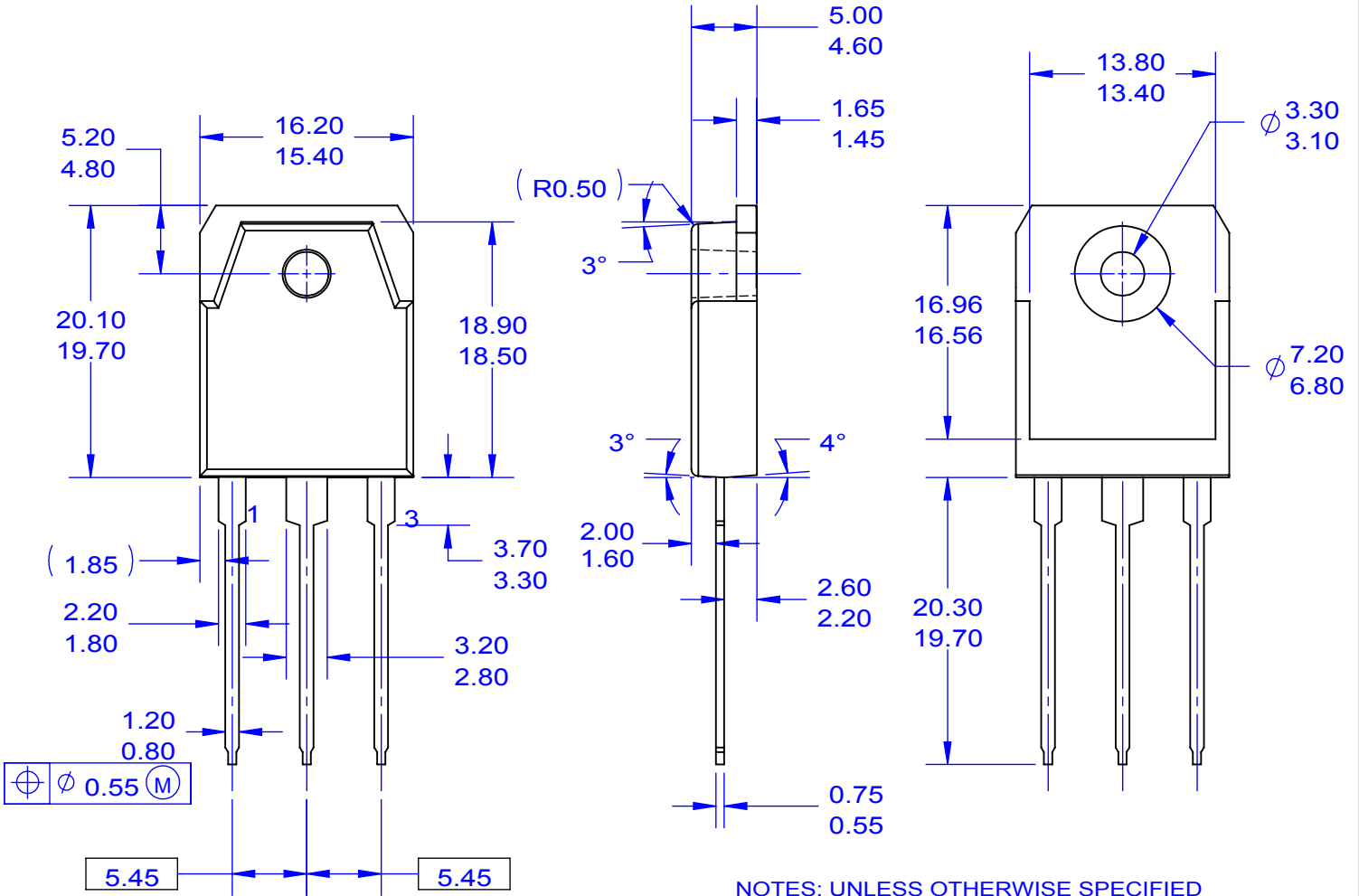

Figure 22. Transient Thermal Impedance of Diode





NOTES: UNLESS OTHERWISE SPECIFIED

- A) THIS PACKAGE CONFORMS TO EIAJ SC-65 PACKAGING STANDARD.
- B) ALL DIMENSIONS ARE IN MILLIMETERS.
- C) DIMENSION AND TOLERANCING PER ASME14.5-2009.
- D) DIMENSIONS ARE EXCLUSIVE OF BURRS, MOLD FLASH, AND TIE BAR EXTRUSIONS.
- E) DRAWING FILE NAME: TO3PN03AREV2.
- F) FAIRCHILD SEMICONDUCTOR.

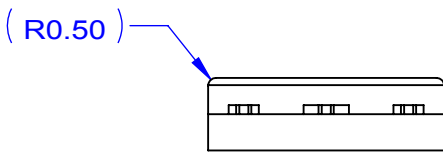

ON Semiconductor and  are trademarks of Semiconductor Components Industries, LLC dba ON Semiconductor or its subsidiaries in the United States and/or other countries. ON Semiconductor owns the rights to a number of patents, trademarks, copyrights, trade secrets, and other intellectual property. A listing of ON Semiconductor's product/patent coverage may be accessed at www.onsemi.com/site/pdf/Patent-Marking.pdf. ON Semiconductor reserves the right to make changes without further notice to any products herein. ON Semiconductor makes no warranty, representation or guarantee regarding the suitability of its products for any particular purpose, nor does ON Semiconductor assume any liability arising out of the application or use of any product or circuit, and specifically disclaims any and all liability, including without limitation special, consequential or incidental damages. Buyer is responsible for its products and applications using ON Semiconductor products, including compliance with all laws, regulations and safety requirements or standards, regardless of any support or applications information provided by ON Semiconductor. "Typical" parameters which may be provided in ON Semiconductor data sheets and/or specifications can and do vary in different applications and actual performance may vary over time. All operating parameters, including "Typicals" must be validated for each customer application by customer's technical experts. ON Semiconductor does not convey any license under its patent rights nor the rights of others. ON Semiconductor products are not designed, intended, or authorized for use as a critical component in life support systems or any FDA Class 3 medical devices or medical devices with a same or similar classification in a foreign jurisdiction or any devices intended for implantation in the human body. Should Buyer purchase or use ON Semiconductor products for any such unintended or unauthorized application, Buyer shall indemnify and hold ON Semiconductor and its officers, employees, subsidiaries, affiliates, and distributors harmless against all claims, costs, damages, and expenses, and reasonable attorney fees arising out of, directly or indirectly, any claim of personal injury or death associated with such unintended or unauthorized use, even if such claim alleges that ON Semiconductor was negligent regarding the design or manufacture of the part. ON Semiconductor is an Equal Opportunity/Affirmative Action Employer. This literature is subject to all applicable copyright laws and is not for resale in any manner.

PUBLICATION ORDERING INFORMATION

LITERATURE FULFILLMENT:

Literature Distribution Center for ON Semiconductor
19521 E. 32nd Pkwy, Aurora, Colorado 80011 USA
Phone: 303-675-2175 or 800-344-3860 Toll Free USA/Canada
Fax: 303-675-2176 or 800-344-3867 Toll Free USA/Canada
Email: orderlit@onsemi.com

N. American Technical Support: 800-282-9855 Toll Free
USA/Canada
Europe, Middle East and Africa Technical Support:
Phone: 421 33 790 2910
Japan Customer Focus Center
Phone: 81-3-5817-1050

ON Semiconductor Website: www.onsemi.com
Order Literature: <http://www.onsemi.com/orderlit>
For additional information, please contact your local
Sales Representative

Mouser Electronics

Authorized Distributor

Click to View Pricing, Inventory, Delivery & Lifecycle Information:

[onsemi:](#)

[FGA40T65SHD](#)