

The SRM400 is a sonar ranging module utilizing our new developed Sonar Ranging IC, PW-0268, which can work with all our PT or EP type transducers. SRM400 provides as a shortcut to develop car reversing systems or some other distance measurement systems for design engineers who are not very familiar with analog circuit and/or the operation of ultrasonic transducers. By using this module engineers can focus firstly on the other fields of digital circuit and software designs as well as some other mechanical issues. After first stage then you can either design your own analog circuit based on the module construction or consult with factory for making your own module for your special needs.

Features:

- Operating Voltage: 6-12Vdc single source
- Operating Frequency: broadband output ranging up to 250KHz
- Built-in variable RC oscillator matching transducers with different frequencies
- High Gain Amplifier: varies with time over 32 steps
- Integrated Band Pass Filter: reduces external component count,
- Bi-direction I/O Pin: simplifies the control function for transmitting a pulse and receiving an echo
- An adjustable System Clock: enables the control of, the number of pulses transmitted, the slope of the variable gain amplifier, and the pulse repetition rate
- Board size: 27.9 * 18 mm (L*W)

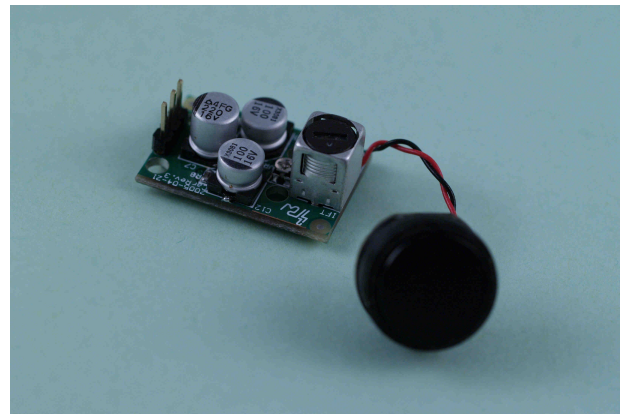

Specification:

Operation voltage	DC6 - 12V
Operation current	<30 mA @DC12V, pulse width 0.5ms, ≥20ms Repetition rate
Oscillation frequency	Variable RC oscillator
Amplifier gain	
Pre-Amplifier	14 dB
2 nd Stage	30 dB
Amplifier	
Time controlled 32 steps main amplifier	35 dB max.
Bandpass filter	
Fc	38 KHz
Bandwidth	20 KHz
Insertion loss	1 dB
Bi-directional I/O	
Input signal	Open collector pull low
Output	0.05*Vcc to 0.9*Vcc digital echo signals
Measuring distance	25 – 150 cm

SRM400 includes:

1. Module board
2. 400EP14D enclosed type transducer of asymmetrical beam patterns, see detail specification of 400EP14D.
3. Detail electrical schematic

Electronic Circuit Diagram:

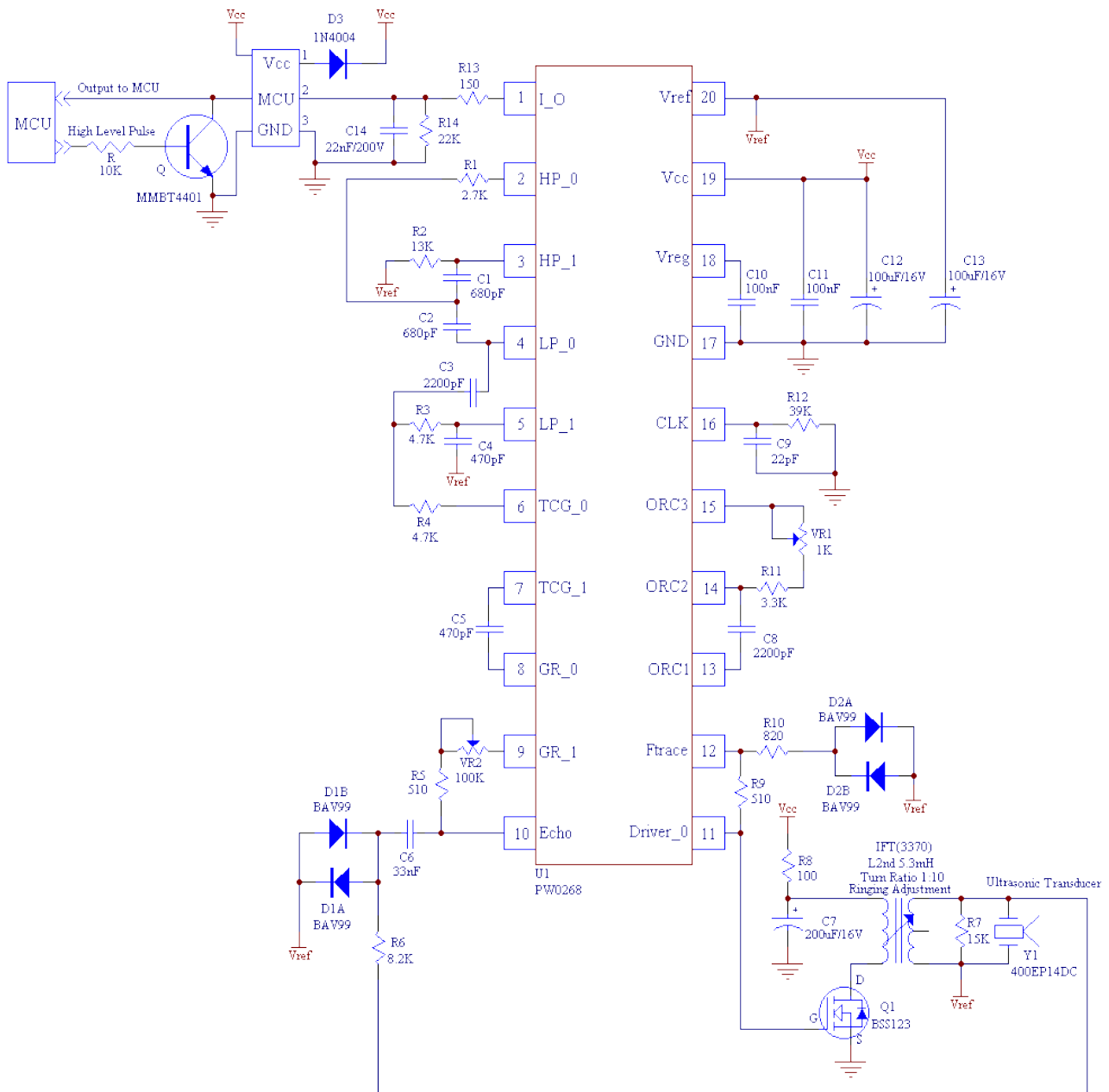

Waveforms at different test points:

works with transducer model 400EP14D against a hard target of size of 20cmL*20cmW*1cmT at distance of 50cm

“A” Point: Control Pulse (from MCU)

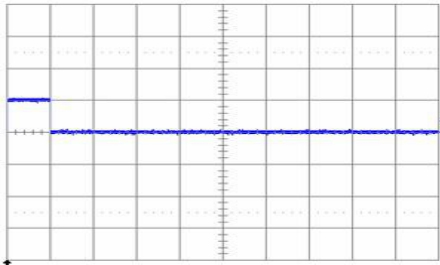

H: 0.5ms/div
V: 5V/div

“B” Point: Tone bursts Signal

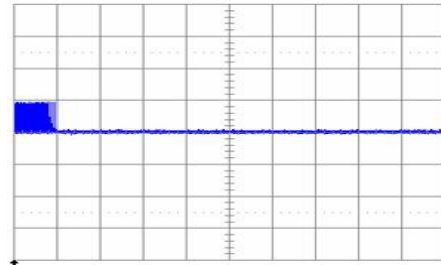

H: 0.5ms/div
V: 5V/div

“C” Point: Transducer loading

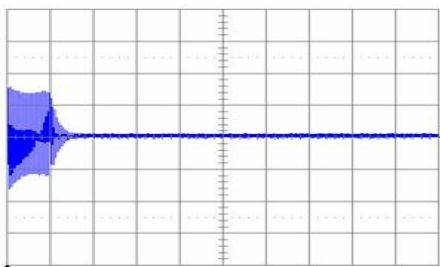

H: 0.5ms/div
V: 50V/div

“D” Point: 1st Pre-Amplifier

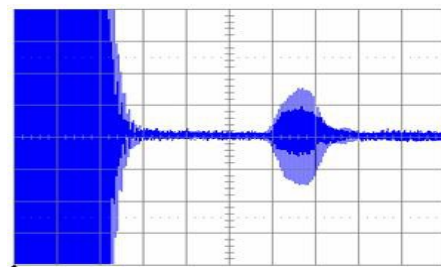

H: 0.5ms/div
V: 20mV/div

“E” Point: Main 32 Steps TCG Amplifier

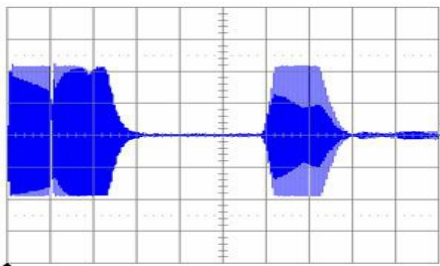

H: 0.5ms/div
V: 1V/div

“F” Point: Digital Echo signal Output

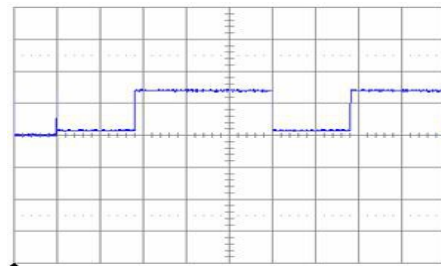

H: 0.5ms/div
V: 5V/div

Refer to [PW-0268 Sonar Ranging IC](#) for detail information.



S. Square Enterprise Company Limited
Pro-Wave Electronics Corporation

[Http://www.pro-wave.com.tw](http://www.pro-wave.com.tw) ; E-mail: sales@pro-wave.com.tw ; Tel: 886-2-22465101 ; Fax: 886-2-22465105

Mouser Electronics

Authorized Distributor

Click to View Pricing, Inventory, Delivery & Lifecycle Information:

[Pro-Wave Electronics:](#)

[SRM400](#)