

IRAUDAMP17

100W/4Ω x 2 Channel Class D Audio Power Amplifier Using the IR4302

By
Jun Honda, Liwei Zheng

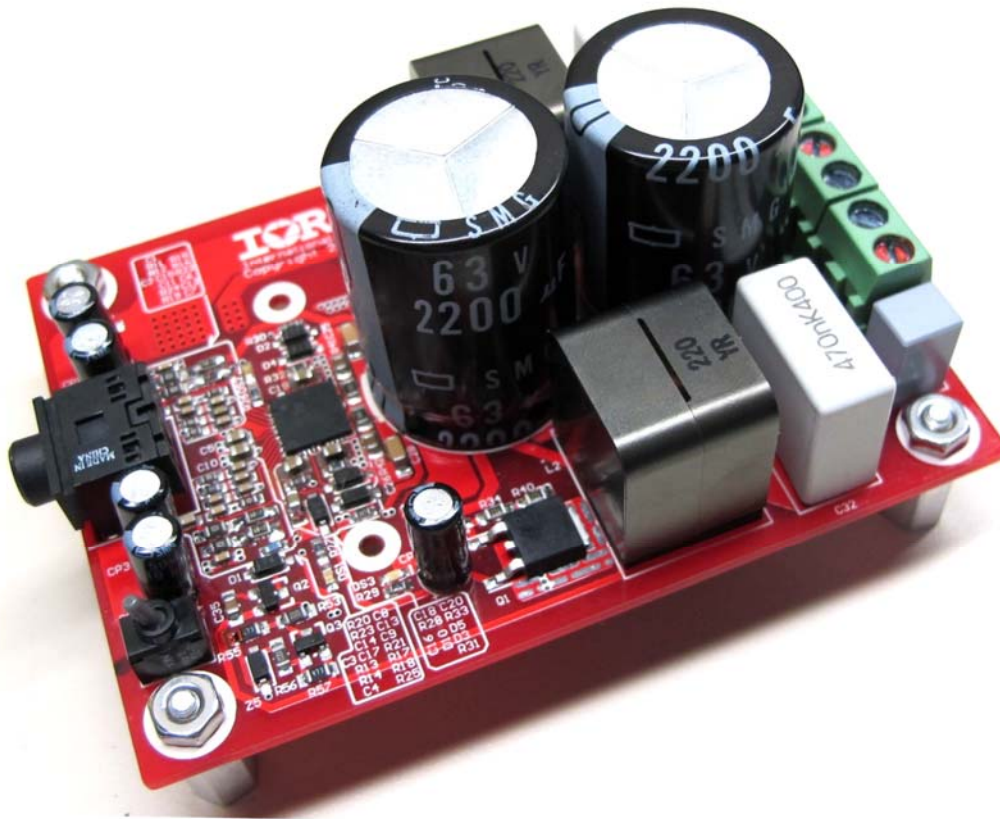

CAUTION:

International Rectifier suggests the following guidelines for safe operation and handling of IRAUDAMP17 Demo board;

- Always wear safety glasses whenever operating Demo Board
- Avoid physical contact with exposed metal surfaces when operating Demo Board
- Turn off Demo Board when placing or removing measurement probes

TABLE OF CONTENTS	PAGE
INTRODUCTION.....	3
SPECIFICATIONS	3
CONNECTION SETUP	4
TEST PROCEDURES.....	5
PERFORMANCE AND TEST GRAPHS	5
THERMAL INFORMATION.....	8
BILL OF MATERIALS	10
PCB SPECIFICATIONS.....	11
REVISION CHANGES DESCRIPTIONS	13

Introduction

The IRAUDAMP17 reference design is a two-channel, 100W/ch (4 Ω/52V Bus voltage) half-bridge Class D audio power amplifier with single power supply. This reference design demonstrates how to use the IR4302 IC with single power supply, implement protection circuits, and design an optimum PCB layout using PowlRaudio integrated Class D IC. This reference design does not require additional heatsink or fan cooling for normal operation (one-eighth of continuous rated power). The reference design provides all the required housekeeping power supplies for ease of use. The two-channel design is scalable for power and the number of channels.

Applications

- AV receivers
- Home theater systems
- Mini component stereos
- Powered speakers
- Sub-woofers
- Musical Instrument amplifiers
- Car audio amplifiers

Features

Output Power:	100W x 2 channels (10%THD+N 4Ω load; with heatsink), 60W x 2 channels (10%THD+N 4Ω load; no heatsink),
Multiple Protection Features:	Over-current protection (OCP), high side and low side Over-voltage protection (OVP), Under-voltage protection (UVP), high side and low side Over-temperature protection (OTP)
PWM Modulator:	Self-oscillating half-bridge topology

Specifications

General Test Conditions (unless otherwise noted)	Notes / Conditions	
Supply Voltages	40V~52V	With heatsink
	30V~42V	*Without heatsink
Load Impedance	2-4Ω	Resistive load
Self-Oscillating Frequency	400kHz	No input signal, Adjustable
Gain Setting	24.8dB	1Vrms input yields rated power

Electrical Data	Typical	Notes / Conditions
IR Devices Used	IR4302 PowlRaudio integrated Class D IC	
Modulator	Self-oscillating, second order sigma-delta modulation, analog input	
Power Supply Range	40V~52V	Single power supply;
	30V~42V	*Without heatsink
Output Power CH1-2: (1% THD+N)	75W	1kHz, 4Ω load, with heatsink
	50W	1kHz, 4Ω load, without heatsink
Output Power CH1-2: (10% THD+N)	100W	1kHz, 4Ω load, with heatsink
	60W	1kHz, 4Ω load, without heatsink
Rated Load Impedance	2-4Ω	Resistive load
Idling Supply Current	65mA	No input signal
Total Idle Power Consumption	3.4W	No input signal
Distortion	0.008%	THD+N @ 30W, 4Ω

Residual Noise	220 μ V	IHF-A weighted, AES-17 filter
Channel Efficiency	96%	Single-channel driven, 100W Class D stage

*Need to change components as below to achieve 30V~42V power supply voltage range without heatsink

	With Heatsink	Without Heatsink
Power Supply Voltage Range	40~52V	30~42V
R7~R10	390 Ω	240 Ω
Z5	36V	27V

Connection Setup

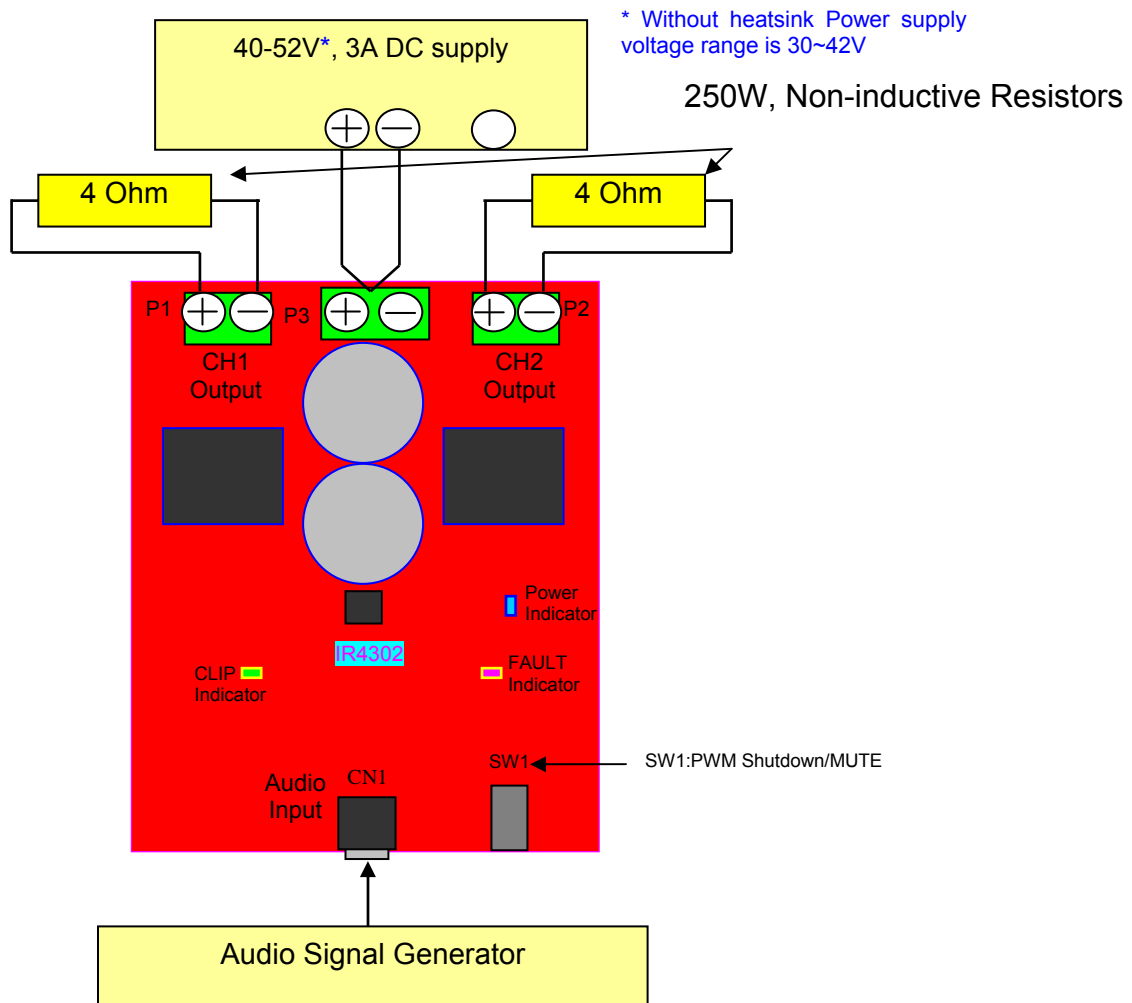

Fig 1 Typical Test Setup

Connector Description

Audio IN	CN1	Analog input for CH1 and CH2
POWER	P3	Single supply
CH1 OUT	P1	Output for CH1
CH2 OUT	P2	Output for CH2

Test Procedures

Test Setup:

1. Connect 4Ω, 250W load to both output connectors, P1 and P2 and audio analyzer (Ap).
2. Connect Audio Signal Generator to CN1 for CH1 and CH2 respectively (Ap).
3. Connect a single power supply to P3 pre-adjusted to 40-52V as shown on Figure above
4. Turn on the power supply.
5. Turn on SW1 (right side).
6. Blue LED (Normal) stays turning on after RED LED extinguished.
7. With an Oscilloscope, monitor switching waveform at VS of CH1 and CH2.
8. Quiescent current for the power supply should be 70mA ±10mA at 52V.

Functionality Audio Tests:

9. Sweep the audio signal voltage from 15 mV_{RMS} to 1.5 V_{RMS}.
10. Monitor the output signals at P1/P2 with an oscilloscope. The waveform must be a non distorted sinusoidal signal with input sinusoidal signal below 1Vrms.

Performance and Test Graphs

Power vs THD+N

Test Conditions:

VBus = 52V(with heatsink)
Input Signal=1 kHz
Load Impedance = 4 ohms

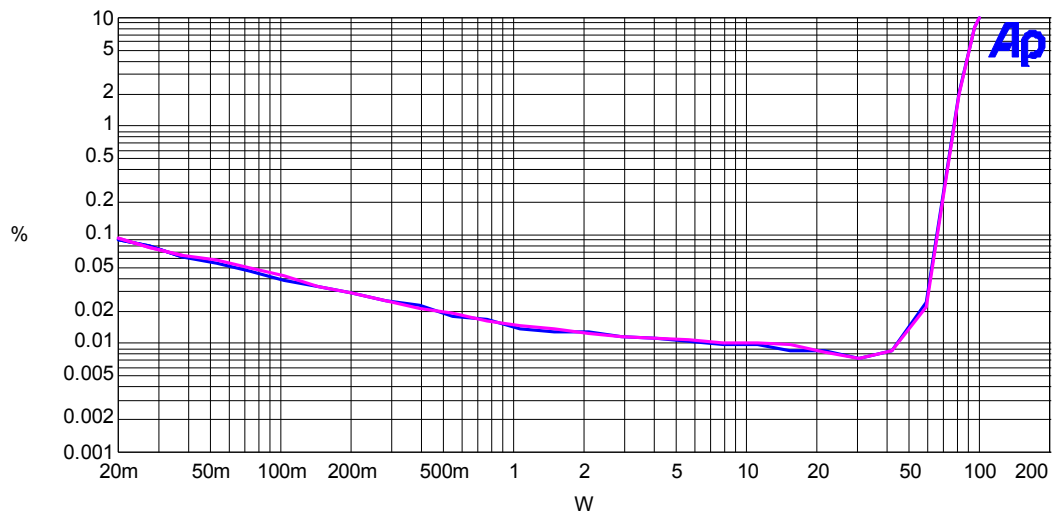

Sweep	Trace	Color	Line Style	Thick	Data	Axis	Comment
1	1	Blue	Solid	2	Anlr.TH+D+N Ratio	Left	CH1 4ohms 52V
1	3	Magenta	Solid	2	Anlr.TH+D+N Ratio	Left	CH2 4ohms 52V

Fig 2

Test Conditions:

VBus = 42V(without heatsink)
Input Signal=1 kHz
Load Impedance = 4 ohms

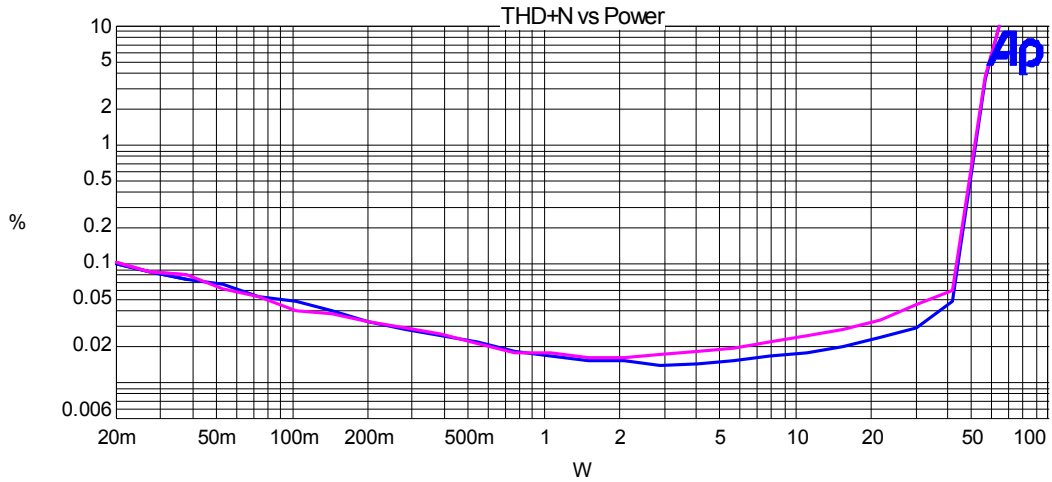

Sweep	Trace	Color	Line Style	Thick	Data	Axis	Comment
1	1	Blue	Solid	2	Anlr. THD+N Ratio	Left	Ch1 42V 4ohms
1	3	Magenta	Solid	2	Anlr. THD+N Ratio	Left	Ch2 42V 4ohms

Fig 3

Frequency Response

Test Conditions:

VBus = 52V
Set Output = 1V
Load Impedance = 4 ohms

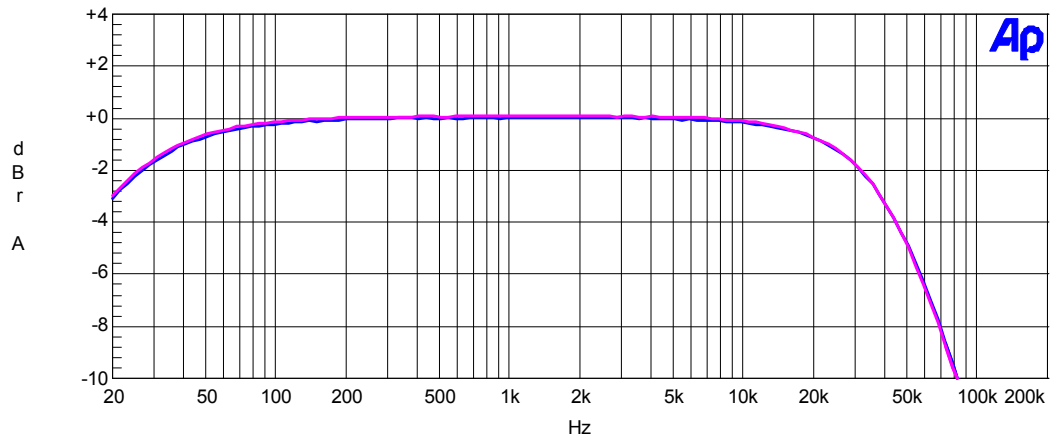

Sweep	Trace	Color	Line Style	Thick	Data	Axis	Comment
1	1	Blue	Solid	2	Anlr. Level A	Left	Ch1 52V 4ohms
1	2	Magenta	Solid	2	Anlr. Level B	Left	Ch2 52V 4ohms

Fig 4

Noise Floor

Test Conditions:

VBus = 52V
Load Impedance = 4 ohms
No Input Signal

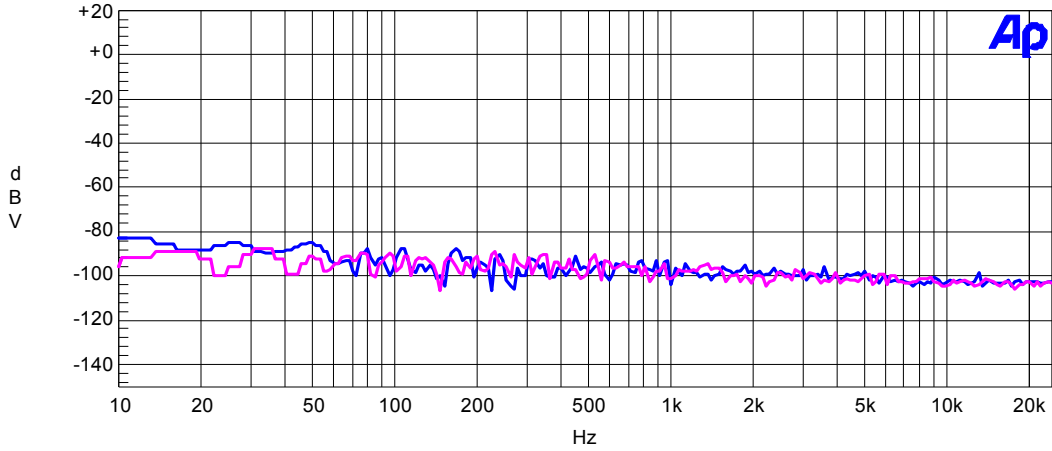

Sweep	Trace	Color	Line Style	Thick	Data	Axis	Comment
1	1	Blue	Solid	2	Ft.Ch.1 Ampl	Left	Ch1
1	2	Magenta	Solid	2	Ft.Ch.2 Ampl	Left	Ch2

Fig5

Noise Floor with 1Vrms Output

Test Conditions:

VBus = 52V
Set Output= 1Vrms @ 1 KHz
Load Impedance = 4 ohms

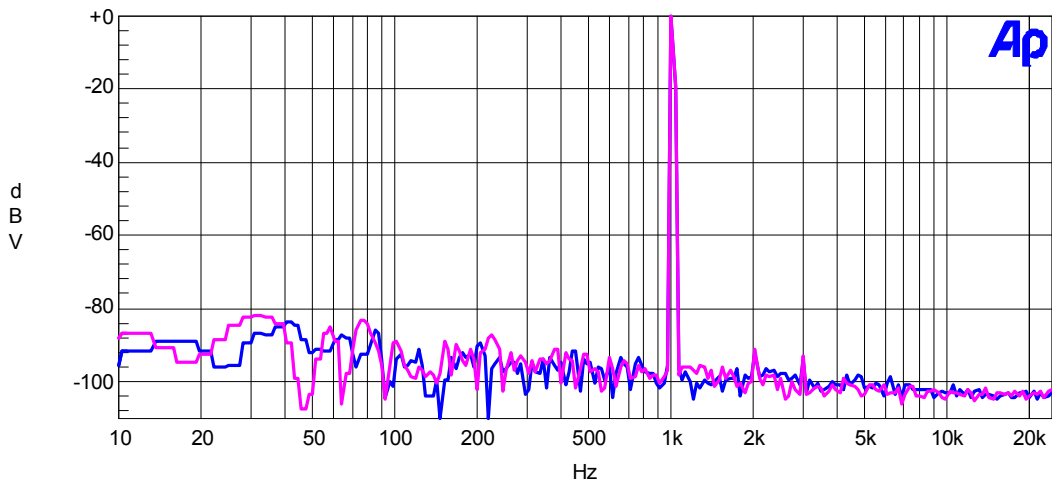

Sweep	Trace	Color	Line Style	Thick	Data	Axis	Comment
1	1	Blue	Solid	2	Ft.Ch.1 Ampl	Left	Ch1
1	2	Magenta	Solid	2	Ft.Ch.2 Ampl	Left	Ch2

Fig 6

Efficiency

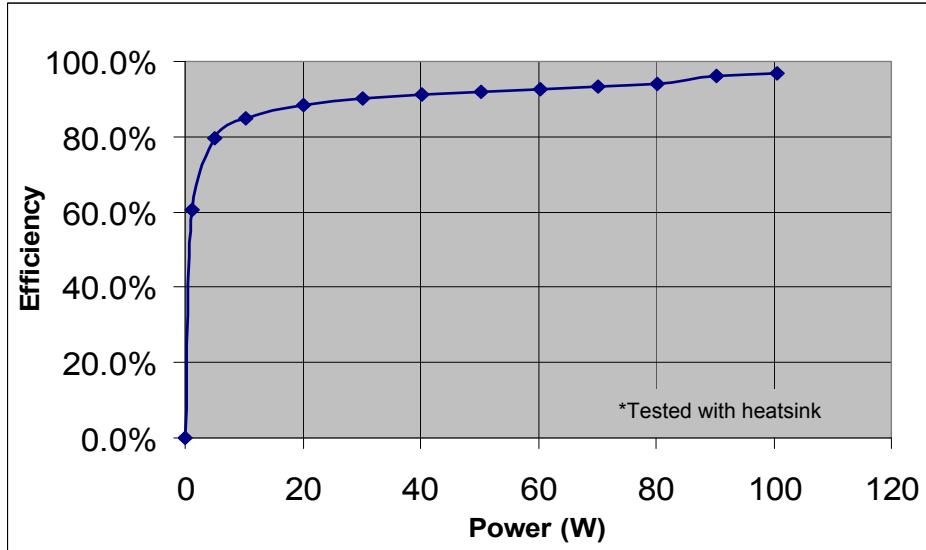

Fig 7

Thermal Information:

1/8 Po Thermal Test

Conditions:

- Tamb=25°C natural convection cooling
- Both Channel Driven 1/8Po continuous 30mins
- Temperature measured by infrared camera

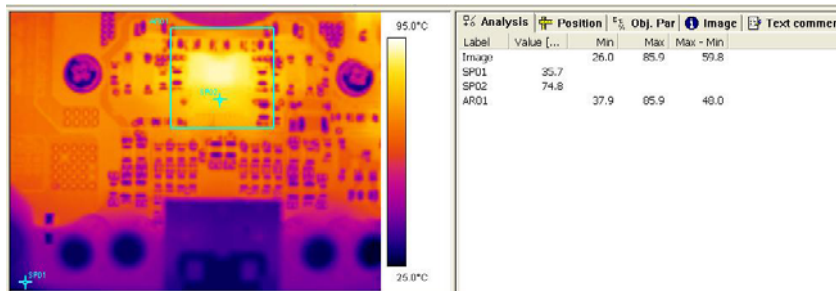

Fig 8 IRAUDAMP17 with heatsink (Vbus=52V)
IR4302's temperature saturated around 85°C within 30minutes

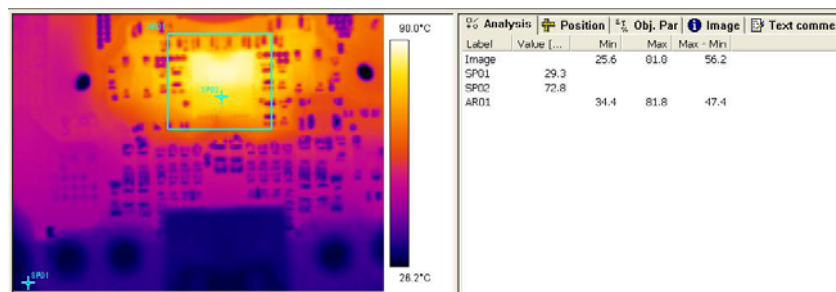
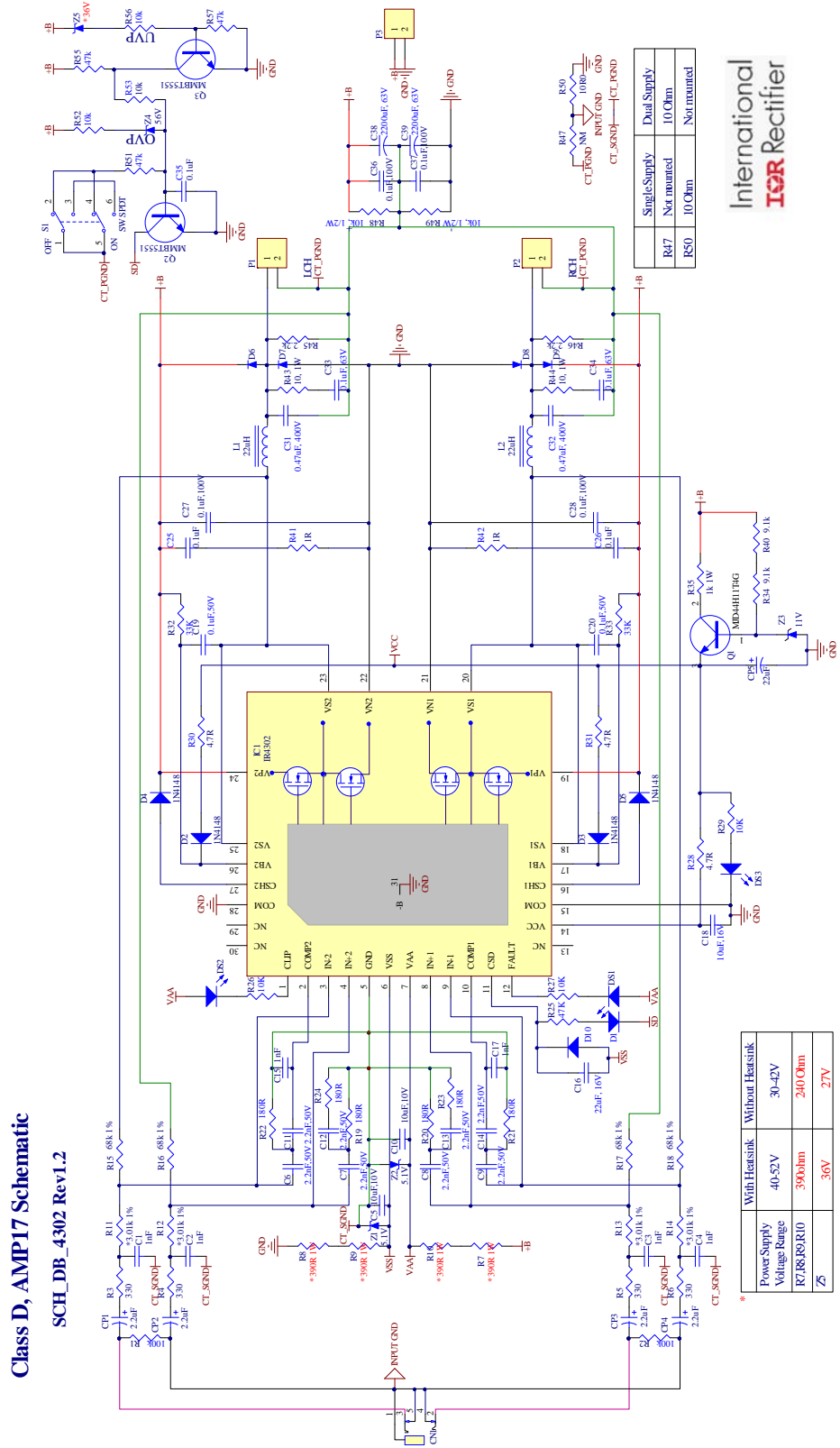

Fig 9 IRAUDAMP17 without heatsink (Vbus=42V)
IR4302's temperature saturated around 82°C within 30minutes

Schematic



Class D, AMP17 Schematic
SCH_DB_4302 Rev1.2

Single Supply	Dual Supply
R47	Not mounted
R50	10 Ohm
R50	Not mounted
R50	10 Ohm

International
IOR Rectifier

	With Heatsink	Without Heatsink
Power Supply Voltage Range	40-52V	30-42V
R7, R8, R9, R10	390 Ohm	240 Ohm
Z5	36V	27V

Fig 10

Bill of Materials

No	Digikey P/N	Designator	Description	Quantity	Vender
1	399-1082-1-ND	C1, C2, C3, C4, C15, C17	CAP CER 1000PF 50V 10% X7R 0603	6	Digikey
2	587-2668-1-ND	C5, C10	CAP CER 10UF 10V 10% X7R 0805	2	Digikey
3	490-1500-1-ND	C6, C7, C8, C9, C11, C12, C13, C14	CAP CER 2200PF 50V 10% X7R 0603	8	Digikey
4	587-1433-1-ND	C16	CAP CER 22UF 16V 20% X5R 1206	1	Digikey
5	490-5519-1-ND	C18	CAP CER 10UF 16V 10% X6S 0805	1	Digikey
6	311-1140-1-ND	C19, C20	CAP CER 0.1UF 50V 10% X7R 0805	2	Digikey
7	445-1418-1-ND	C25, C26	CAP CER 0.1UF 100V 10% X7R 0805	2	Digikey
8	445-1377-1-ND	C27, C28, C36, C37	CAP CER 0.1UF 100V 10% X7R 1206	4	Digikey
9	495-1315-ND	C31, C32	CAP FILM 0.47UF 400VDC RADIAL	2	Digikey
10	BC2054-ND	C33, C34	CAP FILM 0.1UF 63VDC RADIAL	2	Digikey
11	445-1418-1-ND	C35	CAP CER 0.1UF 100V 10% X7R 0805	1	Digikey
12	565-1137-ND	C38, C39	CAP ALUM 2200UF 63V 20% RADIAL	2	Digikey
13	CP1-3545N-ND	CN1	CONN JACK STEREO R/A 5PIN 3.5MM	1	Digikey
14	565-1103-ND	CP1, CP2, CP3, CP4	CAP ALUM 2.2UF 50V 20% RADIAL	4	Digikey
15	565-1056-ND	CP5	CAP ALUM 22UF 25V 20% RADIAL	1	Digikey
16	1N4148W-FDICT-ND	D1, D2, D3, D4, D5, D10	DIODE SWITCH 100V 400MW SOD123	6	Digikey
17	DFLU1200-7DICT-ND	D6, D7, D8, D9	DIODE ULTRA FAST POWERDI 123	4	Digikey
18	160-1181-1-ND	DS1	LED RED CLEAR 0603 SMD	1	Digikey
19	160-1183-1-ND	DS2	LED GREEN CLEAR 0603 SMD	1	Digikey
20	160-1646-1-ND	DS3	LED BLUE CLEAR 0603 SMD	1	Digikey
21	IR4302	IC1	2 CH PowIRaudio integrated Class D IC	1	IR
22	Sagami 7G17A-220M-R	L1, L2	Power Inductors Class D Inductor 22uH	2	Inductors, Inc
23	281-1414-ND	P1, P2, P3	CONN TERM BLOCK PCB 5.0MM 2POS	3	Digikey
24	MJD44H11T4GOSCT-ND	Q1	TRANS PWR NPN 8A 80V DPAK	1	Digikey
25	MMBT5551FSCT-ND	Q2, Q3	TRANSISTOR NPN 160V SOT-23	2	Digikey
26	RMCF0603JT100KCT-ND	R1, R2	RES 100K OHM 1/10W 5% 0603 SMD	2	Digikey
27	RMCF0603JT330RCT-ND	R3, R4, R5, R6	RES 330 OHM 1/10W 5% 0603 SMD	4	Digikey
28	RMCF2512JT390RCT-ND	R7, R8, R9, R10	RES 390 OHM 1W 5% 2512 SMD	4	Digikey
29	RHM3.01KCRCT-ND	R11, R12, R13, R14	RES 3.01K OHM 1/8W 1% 0805 SMD	4	Digikey
30	311-68.0KCRCT-ND	R15, R16, R17, R18	RES 68.0K OHM 1/8W 1% 0805 SMD	4	Digikey
31	RHM180GCT-ND	R19, R20, R21, R22, R23, R24	RES 180 OHM 1/10W 5% 0603 SMD	6	Digikey
32	RHM47KGCT-ND	R25	RES 47K OHM 1/10W 5% 0603 SMD	1	Digikey
33	RHM10KGCT-ND	R26, R27, R29	RES 10K OHM 1/10W 5% 0603 SMD	3	Digikey
34	RMCF0603JT4R70CT-ND	R28, R30, R31	RES TF 1/10W 4.7 OHM 5% 0603	3	Digikey
35	RHM33KGCT-ND	R32, R33	RES 33K OHM 1/10W 5% 0603 SMD	2	Digikey
36	RHM9.1KARCT-ND	R34, R40	RES 9.1K OHM 1/8W 5% 0805 SMD	2	Digikey
37	PT1.0KXCT-ND	R35	RES 1.0K OHM 1W 5% 2512 SMD	1	Digikey
38	P1.0ACT-ND	R41, R42	RESISTOR 1.0 OHM 1/8W 5% 0805	2	Digikey
39	541-10.0AFCT-ND	R43, R44	RES 10.0 OHM 1W 1% 2512 SMD	2	Digikey
40	RMCF0805JT2K20CT-ND	R45, R46	RES 2.2K OHM 1/8W 5% 0805 SMD	2	Digikey
41	541-10KVCT-ND	R48, R49	RES 10K OHM 1/2W 5% 1210 SMD	2	Digikey
42	311-10ARCT-ND	R50	RES 10 OHM 1/8W 5% 0805 SMD	1	Digikey
43	RHM47KARCT-ND	R51, R55, R57	RES 47K OHM 1/8W 5% 0805 SMD	3	Digikey

44	RHM10KARCT-ND	R52, R53, R56	RES 10K OHM 1/8W 5% 0805 SMD	3	Digikey
45	360-1758-ND	S1	SWITCH TOGGLE SPDT .4VA SEAL PCB	1	Digikey
46	DDZ5V1BDICT-ND	Z1, Z2	DIODE ZENER 5.1V 500MW SOD-123	2	Digikey
47	BZT52C11-FDICT-ND	Z3	DIODE ZENER 11V 500MW SOD123	1	Digikey
48	MMSZ5263BT1GOSCT-ND	Z4	DIODE ZENER 56V 500MW SOD-123	1	Digikey
49	BZT52C36-FDICT-ND	Z5	DIODE ZENER 36V 500MW SOD-123	1	Digikey
50	8401K-ND	1/2" Standoffs 4-40	STDOFF HEX M/F 4-40 .500"L ALUM	4	Digikey
51	H724-ND	4-40 Nut	NUT HEX 4-40 STAINLESS STEEL	4	Digikey
52	H729-ND	No. 4 Lock Washer	WASHER LOCK INTERNAL #4 SS	4	Digikey
53	BER161-ND	Thermal Pad	THERMAL PAD .020" 4X4" GAPPAD	1/6	Digikey

IRAUDAMP17 Heatsink

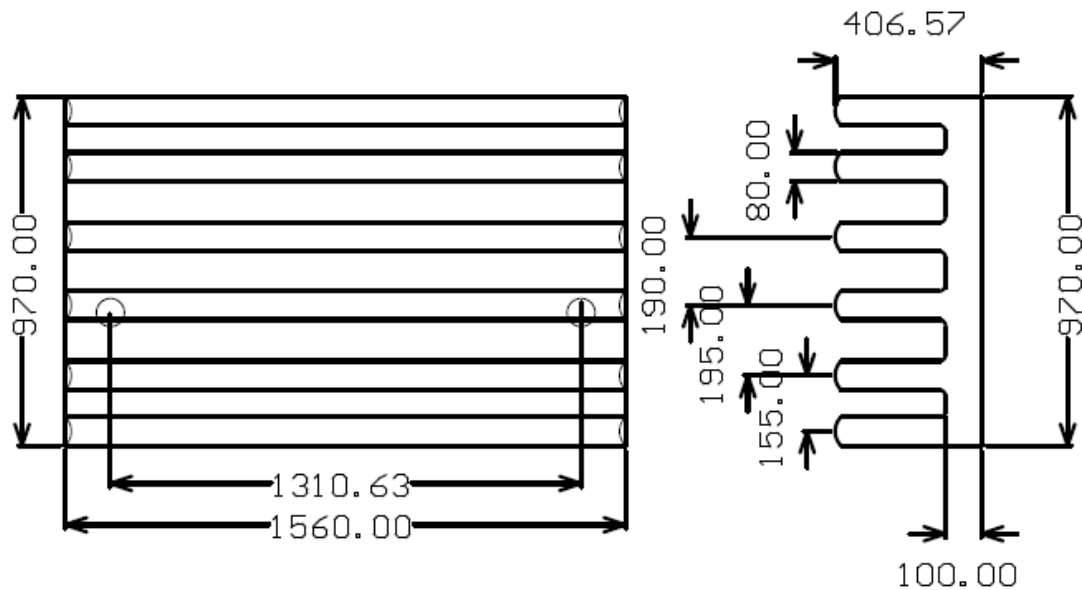

Fig11

PCB Specifications

PCB:

1. Two Layers SMT PCB with through holes
2. 1/16 thickness
3. 2/0 OZ Cu
4. FR4 material
5. 10 mil lines and spaces
6. Solder Mask to be Green enamel EMP110 DBG (CARAPACE) or Enthone Endplate DSR-3241 or equivalent.
7. Silk Screen to be white epoxy non conductive per IPC-RB 276 Standard.
8. All exposed copper must finished with TIN-LEAD Sn 60 or 63 for 100u inches thick.
9. Tolerance of PCB size shall be 0.010 –0.000 inches
10. Tolerance of all Holes is $-.000 + 0.003$ "
11. PCB acceptance criteria as defined for class II PCB'S standards.

PCB Layout
 Top side:

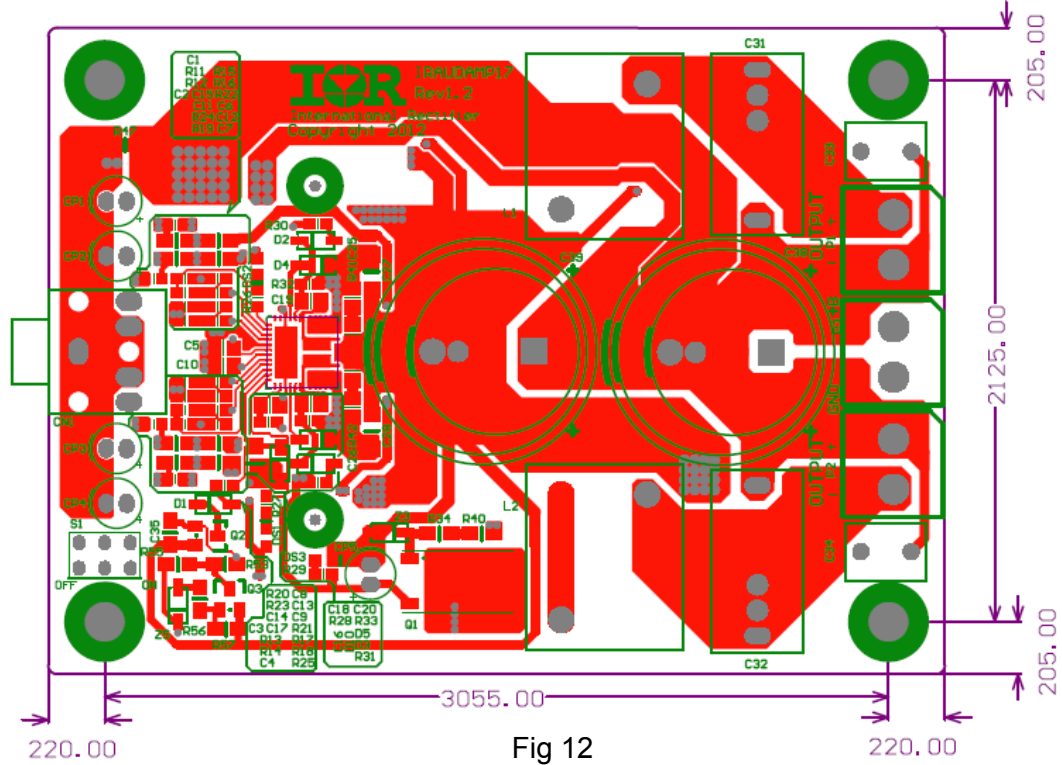

Fig 12

Bottom side:

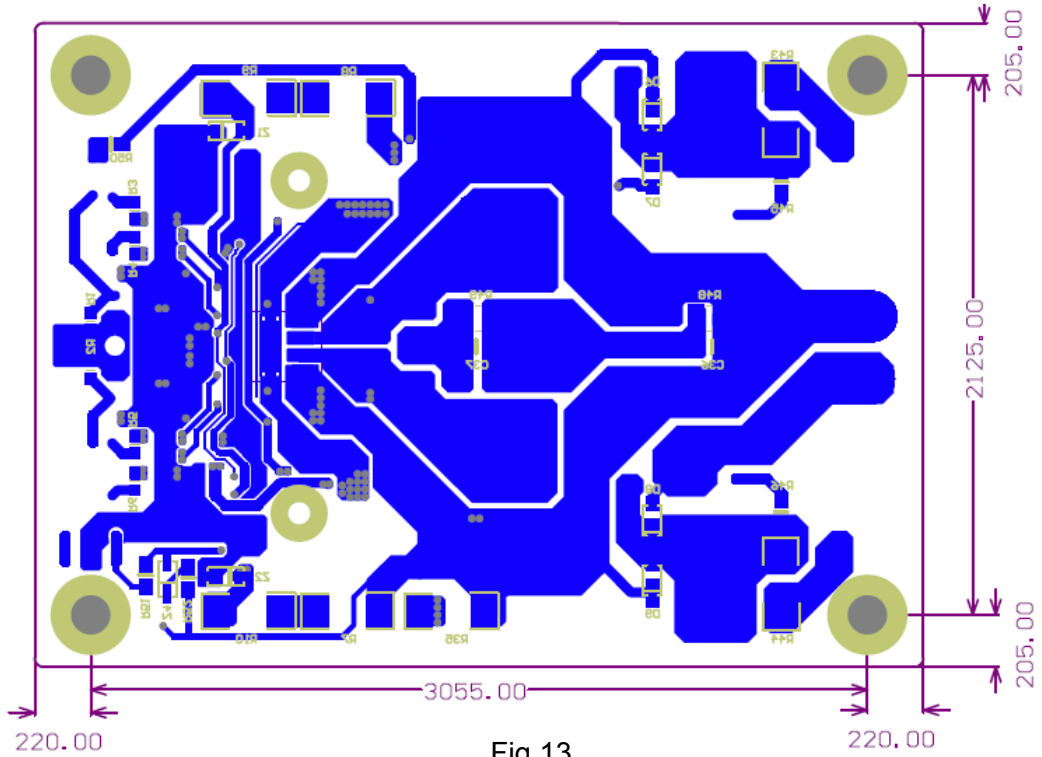

Fig 13

Note: Refer to AN1170 for footprint and board mounting details.

Revision changes descriptions

Revision	Changes description	Date
Rev 1.0	Released	May, 16 2012
Rev 1.1	BOM R50=10ohm	May, 24 2012

Mouser Electronics

Authorized Distributor

Click to View Pricing, Inventory, Delivery & Lifecycle Information:

[Infineon:](#)

[IRAUDAMP17](#)