

Features

- 1208 side view SMD LED
- High Brightness
- AllInGaP / InGaN Technology
- Small package
- High reliability
- Clear Lens

Applications

- Consumer Electronics
- Wearable
- Automobile After Market
- Industrial Equipment

Description

The IN-S121AS series is a popular low profile 1208 package with versatile design capabilities. It is a PCB type molding style LED which can be used in various applications.

Recommended Solder Pattern

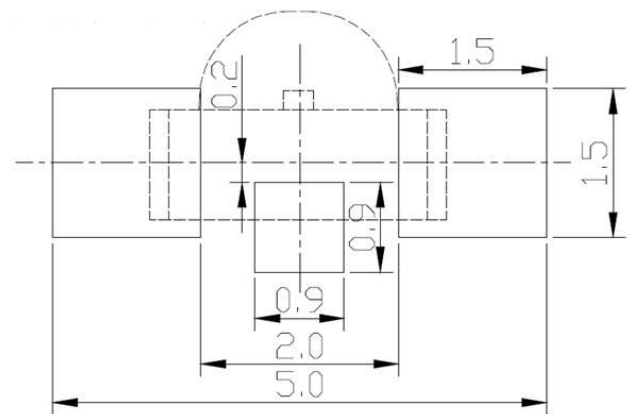

Figure 1. IN-S121AS Solder Pattern

Package Dimensions in mm

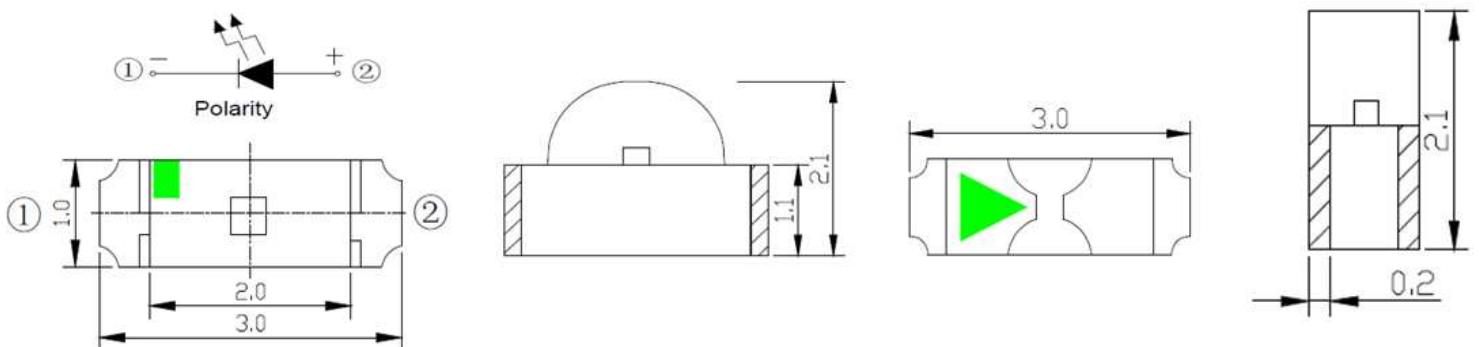

Figure 2. IN-S121AS Package Dimensions

Absolute Maximum Rating at 25°C (Note 1)

Product	Emission Color	P _d (mW)	I _F (mA)	I _{FP} * (mA)	V _R (V)	T _{OP} (°C)	T _{ST} (°C)
IN-S121ASYG	Yellow Green	75	25	70	5	-30°C~+85°C	-40°C~+90°C
IN-S121ASY	Yellow	75	25				
IN-S121AS5A	Amber	75	25				
IN-S121ASR	Red	75	25				
IN-S121AS5B	Blue	75	25	100	5	-30°C~+85°C	-40°C~+90°C
IN-S121ASG	Green	75	25				
IN-S121ASUW	White	75	25				

Notes

1. Condition for IFP is pulse of 1/10 duty and 0.1msec width

ESD Precaution

ATTENTION: Electrostatic Discharge (ESD) protection



The symbol above denotes that ESD precaution is needed. ESD protection for GaP and AlGaAs based chips is necessary even though they are relatively safe in the presence of low static-electric discharge. Parts built with AlInGaP, GaN, or/and InGaN based chips are STATIC SENSITIVE devices. ESD precaution must be taken during design and assembly. If manual work or processing is needed, please ensure the device is adequately protected from ESD during the process.

Please be advised that normal static precautions should be taken in the handling and assembly of this device to prevent damage or degradation which may be induced by electrostatic discharge (ESD).

Electrical Characteristics $T_A = 25^\circ\text{C}$ (Note 1)

Product	Emission Color	$I_F(\text{mA})$	$V_F(\text{V})$		$\lambda(\text{nm})$			Viewing Angle	$I_v(\text{mcd})$
			min	max	λ_D	λ_P	$\Delta\lambda$	$2\theta_{1/2}$	typ.
IN-S121ASYG	Yellow Green	20	1.8	2.6	572	576	15	120	40
IN-S121ASY	Yellow	20	1.8	2.6	589	595	15	120	140
IN-S121AS5A	Amber	5	1.8	2.2	605	610	17	120	35
IN-S121ASR	Red	20	1.8	2.6	622	625	20	120	140
IN-S121AS5B	Blue	5	2.7	3.1	467	473	30	120	45
IN-S121ASG	Green	20	2.8	3.6	520	530	35	120	560
IN-S121ASUW	White	20	2.7	3.6	X=0.29 Y=0.29	-	-	120	900

Notes

1. Performance guaranteed only under conditions listed in above tables.

Chromaticity Bin (for White only)

Bin Code	CIE-X	CIE-Y	Bin Code	CIE-X	CIE-Y	Bin Code	CIE-X	CIE-Y	Bin Code	CIE-X	CIE-Y
A5	0.2545	0.2480	B1	0.2640	0.2670	C1	0.2830	0.3050	D1	0.2920	0.3060
	0.2589	0.2445		0.2680	0.2623		0.2863	0.2978		0.2935	0.3015
	0.2680	0.2623		0.2772	0.2800		0.2923	0.3052		0.2997	0.3088
	0.2640	0.2670		0.2735	0.2860		0.2895	0.3134		0.2984	0.3133
A6	0.2589	0.2445	B2	0.2720	0.2575	C2	0.2863	0.2978	D2	0.2935	0.3015
	0.2633	0.2410		0.2680	0.2623		0.2895	0.2905		0.2950	0.2970
	0.2720	0.2575		0.2772	0.2800		0.2950	0.2970		0.3009	0.3042
	0.2680	0.2623		0.2808	0.2740		0.2923	0.3052		0.2997	0.3088
A7	0.2677	0.2375	B3	0.2720	0.2575	C3	0.2895	0.2905	D3	0.2950	0.2970
	0.2633	0.2410		0.2760	0.2528		0.2928	0.2833		0.2965	0.2925
	0.2720	0.2575		0.2844	0.2680		0.2977	0.2891		0.3023	0.2990
	0.2760	0.2528		0.2808	0.2740		0.2950	0.2970		0.3009	0.3042
A8	0.2720	0.2340	B4	0.2760	0.2528	C4	0.2928	0.2833	D4	0.2965	0.2925
	0.2677	0.2375		0.2844	0.2680		0.2977	0.2891		0.2980	0.2880
	0.2760	0.2528		0.2880	0.2620		0.3003	0.2812		0.3037	0.2937
	0.2800	0.2480		0.2800	0.2480		0.2960	0.2760		0.3023	0.2990
E1	0.2984	0.3133	B5	0.2735	0.2860	C5	0.2883	0.3172	D5	0.2937	0.3312
	0.2997	0.3088		0.2772	0.2800		0.2870	0.3210		0.2950	0.3266
	0.3058	0.3160		0.2863	0.2978		0.2937	0.3312		0.3017	0.3360
	0.3048	0.3207		0.2830	0.3050		0.2950	0.3266		0.3005	0.3415
E2	0.2997	0.3088	B6	0.2772	0.2800	C6	0.2883	0.3172	D6	0.2950	0.3266
	0.3009	0.3042		0.2808	0.2740		0.2950	0.3266		0.2962	0.3220
	0.3068	0.3113		0.2895	0.2905		0.2962	0.3220		0.3028	0.3304
	0.3058	0.3160		0.2863	0.2978		0.2895	0.3134		0.3017	0.3360
E3	0.3009	0.3042	B7	0.2808	0.2740	C7	0.2895	0.3134	D7	0.2962	0.3220
	0.3023	0.2990		0.2844	0.2680		0.2908	0.3097		0.2973	0.3177
	0.3081	0.3053		0.2928	0.2833		0.2973	0.3177		0.3038	0.3256
	0.3068	0.3113		0.2895	0.2905		0.2962	0.3220		0.3028	0.3304
E4	0.3023	0.2990	B8	0.2844	0.2680	C8	0.2908	0.3097	D8	0.2973	0.3177
	0.3037	0.2937		0.2928	0.2833		0.2920	0.3060		0.2984	0.3133
	0.3093	0.2993		0.2960	0.2760		0.2984	0.3133		0.3048	0.3207
	0.3081	0.3053		0.2880	0.2620		0.2973	0.3177		0.3038	0.3256
Z2	0.25	0.251	Z3	0.26	0.271	Z4	0.27	0.291	Z5	0.28	0.311
	0.26	0.271		0.27	0.291		0.28	0.311		0.2871	0.321
	0.264	0.267		0.2735	0.286		0.283	0.305		0.2895	0.3134
	0.2545	0.248		0.264	0.267		0.2735	0.286		0.283	0.305
A1	0.2497	0.2267	A2	0.2497	0.2267	A3	0.2593	0.2223	A4	0.2640	0.2200
	0.245	0.229		0.2589	0.2445		0.2677	0.2375		0.2593	0.2223
	0.2545	0.248		0.2633	0.241		0.2633	0.2410		0.2677	0.2375
	0.2589	0.2445		0.2545	0.2245		0.2545	0.2245		0.2720	0.2340
Z1	0.24	0.231									
	0.25	0.251									
	0.2545	0.248									
	0.245	0.2291									

Chromaticity Bin

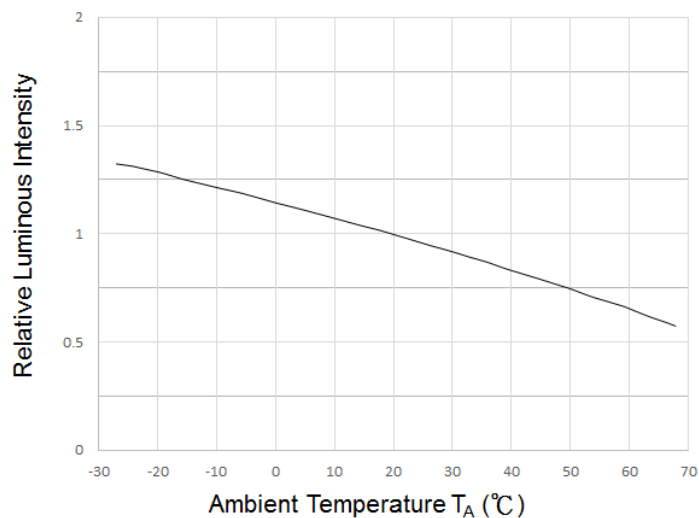
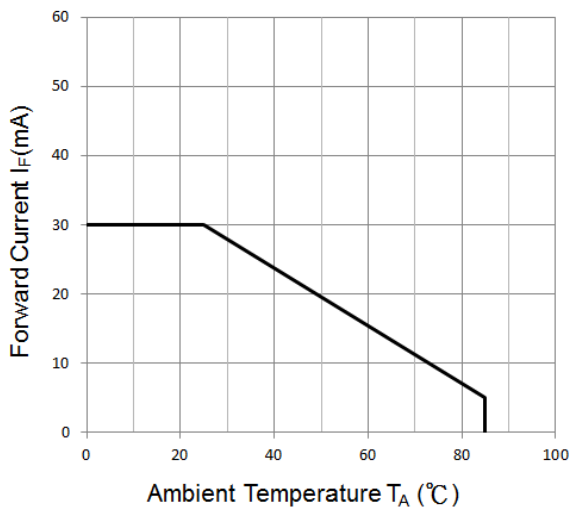
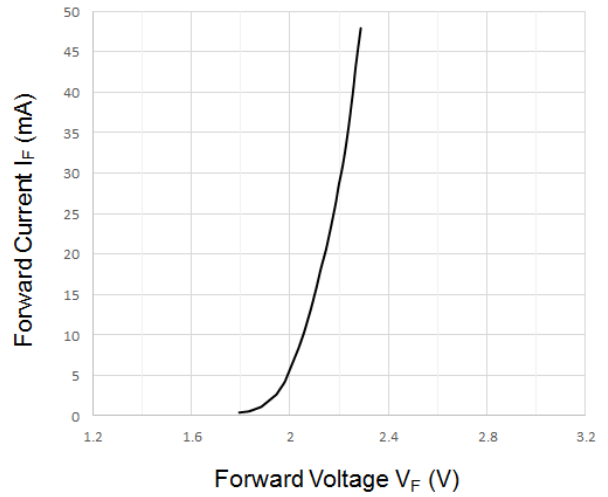

Typical Characteristic Curves – YG, Y, A, R

Typical Characteristic Curves – B, G, W

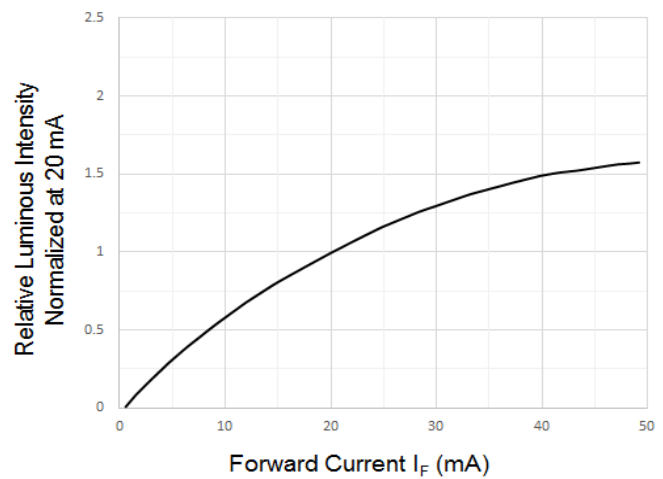
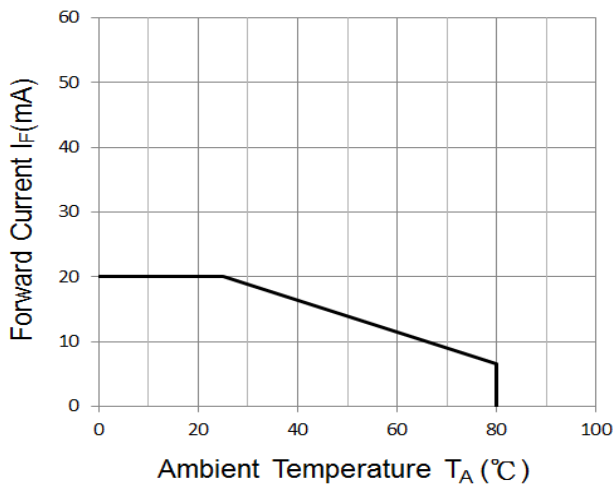
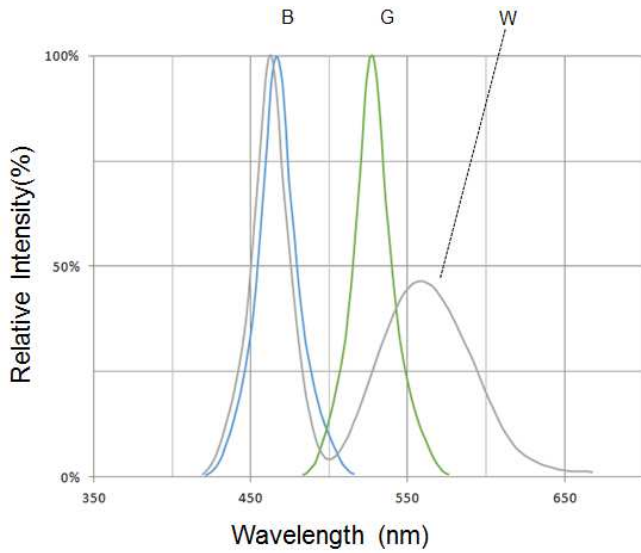

Typical Characteristic Curves – Radiation Pattern

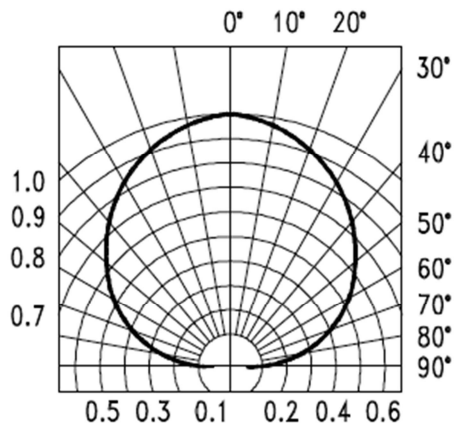

Ordering Information

Product	Emission Color	Technology	Test Current I_F (mA)	Luminous Intensity I_v (mcd) (Typ.)	Forward Voltage V_F (V) (Typ.)	Orderable Part Number
IN-S121ASYG	Yellow Green	AllnGaP	20	40	2.2	IN-S121ASYG
IN-S121ASY	Yellow	AllnGaP	20	140	2.2	IN-S121ASY
IN-S121AS5A	Amber	AllnGaP	5	35	2.0	IN-S121AS5A
IN-S121ASR	Red	AllnGaP	20	140	2.2	IN-S121ASR
IN-S121AS5B	Blue	InGaN	5	45	2.9	IN-S121AS5B
IN-S121ASG	Green	InGaN	20	560	3.2	IN-S121ASG
IN-S121ASUW	White	InGaN	20	900	3.2	IN-S121ASUW

Label Specifications



Inolux P/N:

I	N	-	P	3	2	A	T			X	-	X	X	X	X
Inolux SMD			Material	Package	Variation	Orientation	Current	Lens	Color			Customized Stamp-off			
			S = PCB Type	121A = 3.0 x 1.0 x 2.1 mm		S = Side Mount	(Blank) = 20mA 5=5mA	(Blank) = Clear U = Diffused	R=625nm A=609nm Y=595nm YG=576nm G=530nm B=473nm W=White						

Lot No.:

Z	2	0	1	7	01	24	001
Internal Tracker	Year (2017, 2018,)				Month	Date	Serial

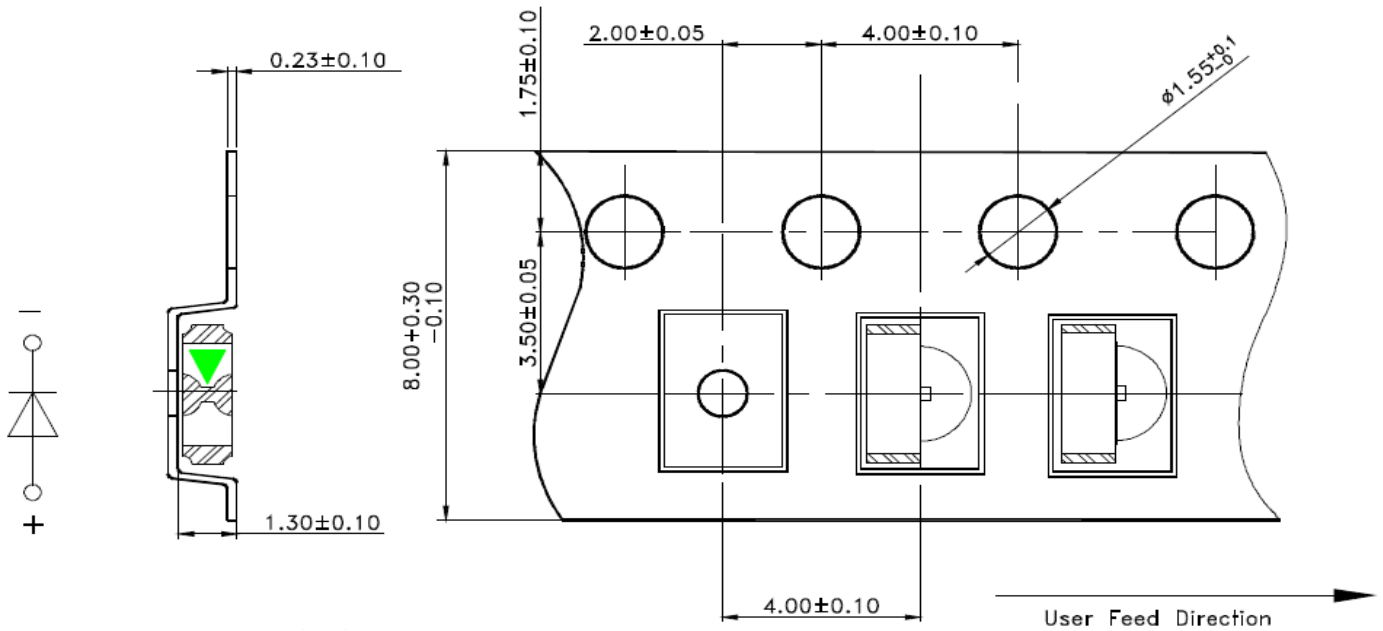
Packaging Information: 3000pcs Per Reel
Tape Dimension

Reel Dimension

Packing Dimension



5 boxes per carton are available depending on shipment quantity.

	Specification	Material	Quantity
Carrier tape	Per EIA 481-1A specs	Conductive black tape	3000pcs per reel
Reel	Per EIA 481-1A specs	Conductive black	
Label	IN standard	Paper	
Packing bag	220x240mm	Aluminum laminated bag/ no-zipper	One reel per bag
Carton	IN standard	Paper	Non-specified

Others:

Each immediate box consists of 5 reels. The 5 reels may not necessarily have the same lot number or the same bin combinations of I_v , λ_D and V_f . Each reel has a label identifying its specification; the immediate box consists of a product label as well.

Dry Pack

All SMD optical devices are **MOISTURE SENSITIVE**. Avoid exposure to moisture at all times during transportation or storage. Every reel is packaged in a moisture protected anti-static bag. Each bag is properly sealed prior to shipment.

Upon request, a humidity indicator will be included in the moisture protected anti-static bag prior to shipment.

The packaging sequence is as follows:



Reflow Soldering

- Recommended tin glue specifications: melting temperature in the range of 178~192 °C
- The recommended reflow soldering profile is as follows (temperatures indicated are as measured on the surface of the LED resin):

Lead-free Solder Profile



Precautions

- Avoid exposure to moisture at all times during transportation or storage.
- Anti-Static precaution must be taken when handling GaN, InGaN, and AlInGaP products.
- It is suggested to connect the unit with a current limiting resistor of the proper size. Avoid applying a reverse voltage.
- Avoid operation beyond the limits as specified by the absolute maximum ratings.
- Avoid direct contact with the surface through which the LED emits light.
- If possible, assemble the unit in a clean room or dust-free environment.

Reworking

- Rework should be completed within 5 seconds under 260 °C.
- The iron tip must not come in contact with the copper foil.
- Twin-head type is preferred.

Cleaning

Following are cleaning procedures after soldering:

- An alcohol-based solvent such as isopropyl alcohol (IPA) is recommended.
- Temperature x Time should be 50°C x 30sec. or <30°C x 3min
- Ultra sonic cleaning: < 15W/ bath; bath volume ≤ 1liter
- Curing: 100 °C max, <3min

Cautions of Pick and Place

- Avoid stress on the resin at elevated temperature.
- Avoid rubbing or scraping the resin by any object.
- Electro-static may cause damage to the component. Please ensure that the equipment is properly grounded. Use of an ionizer fan is recommended.

Reliability

Item	Frequency/ lots/ samples/ failures	Standards Reference	Conditions
Precondition	For all reliability monitoring tests according to JEDEC Level 2	J-STD-020	1.) Baking at 85°C for 24hrs 2.) Moisture storage at 85°C/ 60% R.H. for 168hrs
Solderability	1Q/ 1/ 22/ 0	JESD22-B102-B And CNS-5068	Accelerated aging 155°C/ 24hrs Tinning speed: 2.5+0.5cm/s Tinning: A: 215°C/ 3+1s or B: 260°C/ 10+1s
Resistance to soldering heat		CNS-5067	Dipping soldering terminal only Soldering bath temperature A: 260+/-5°C; 10+/-1s B: 350+/-10°C; 3+/-0.5s
Operating life test	1Q/ 1/ 40/ 0	CNS-11829	1.) Precondition: 85°C baking for 24hrs 85°C/ 60%R.H. for 168hrs 2.) Tamb25°C; IF=20mA; duration 1000hrs
High humidity, high temperature bias	1Q/ 1/ 45/ 0	JESD-A101-B	Tamb: 85°C Humidity: 85% R.H., IF=5mA Duration: 1000hrs
High temperature bias	1Q/ 1/ 20	IN specs.	Tamb: 55°C IF=20mA Duration: 1000hrs
Pulse life test	1Q/ 1/ 40/ 0		Tamb25°C, If=20mA,, Ip=100mA, Duty cycle=0.125 (tp=125 μs, T=1sec) Duration 500hrs)
Temperature cycle	1Q/ 1/ 76/ 0	JESD-A104-A IEC 68-2-14, Nb	A cycle: -40 degree C 15min; +85 degree C 15min Thermal steady within 5 min.. 300 cycles 2 chamber/ Air-to-air type
High humidity storage test	1Q/ 1/ 40/ 0	CNS-6117	60+3°C 90+5/-10% R.H. for 500hrs
High temperature storage test	1Q/ 1/ 40/ 0	CNS-554	100+10°C for 500hrs
Low temperature storage test	1Q/ 1/ 40/ 0	CNS-6118	-40+5°C for 500hrs

Revision History

Changes since last revision	Page	Version No.	Revision Date
Initial Release		1.0	03-16-2017

DISCLAIMER

INOLUX reserves the right to make changes without further notice to any products herein to improve reliability, function or design. INOLUX does not assume any liability arising out of the application or use of any product or circuit described herein; neither does it convey any license under its patent rights, nor the rights of others.

LIFE SUPPORT POLICY

INOLUX's products are not authorized for use as critical components in life support devices or systems without the express written approval of the President of INOLUX or INOLUX CORPORATION. As used herein:

1. Life support devices or systems are devices or systems which, (a) are intended for surgical implant into the body, or (b) support or sustain life, and (c) whose failure to perform when properly used in accordance with instructions for use provided in the labeling, can be reasonably expected to result in a significant injury of the user.
2. A critical component in any component of a life support device or system whose failure to perform can be reasonably expected to cause the failure of the life support device or system, or to affect its safety or effectiveness.

Mouser Electronics

Authorized Distributor

Click to View Pricing, Inventory, Delivery & Lifecycle Information:

Inolux:

[IN-S121AS5A](#) [IN-S121AS5B](#) [IN-S121ASG](#) [IN-S121ASR](#) [IN-S121ASUW](#) [IN-S121ASY](#) [IN-S121ASYG](#)