

General Purpose EMC Filter



- EMC solution for industrial inverters and motor drives
- Rated currents from 8 to 280 A
- Selectable voltage level of 440 V and 520 V
- High differential and common-mode attenuation



Performance indicators

Attenuation performance



Technical specifications

Maximum continuous operating voltage	3x 440/250 VAC (FN 351) 3x 520/300 VAC (FN 351 H)
Operating frequency	DC to 60 Hz
Rated currents	8 to 280 A @ 40°C
High potential test voltage	P → E 2600 VDC for 2 sec (FN 351) P → P 1900 VDC for 2 sec (FN 351) P → E 2750 VDC for 2 sec (FN 351 H) P → P 2250 VDC for 2 sec (FN 351 H)
Protection category	IP 20
Overload capability	4x rated current at switch on, 1.5x rated current for 1 minute, once per hour
Temperature range (operation and storage)	-25°C to +85°C (25/085/21) (FN 351)
Temperature range (operation and storage)	-25°C to +100°C (25/100/21) (FN 351 H)
Flammability corresponding to	UL 94 V-2 or better
Design corresponding to	UL 1283, CSA 22.2 No. 8 1986, IEC/EN 60939
MTBF @ 40°C/400 V (Mil-HB-217F)	135,000 hours

Approvals



Approvals up to 110 A

Features and benefits

- Broad range of power ratings for fast and convenient filter selection
- Available as 440 VAC (FN 351) and 520 VAC (FN 351 H) versions for network-specific applications
- FN 351 filters provide a broadband common and differential-mode attenuation performance, which remains available also when high interference levels are present
- Solid, touch-safe filter terminals contribute to overall equipment safety
- Introduced as one of the very first motor drive EMC filters in the market, FN 351 has been widely imitated and has successfully proven its function over more than 10 years



Typical applications

- Three-phase motor drives
- Inverters and converters
- Industrial automation equipment
- UPS
- SMPS
- General purpose three-phase filtering

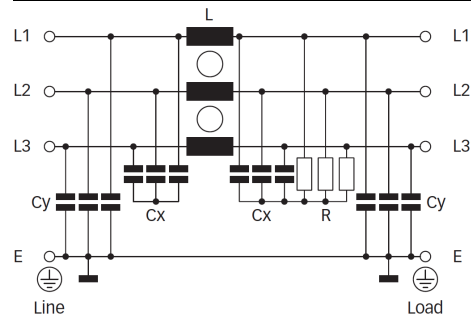
Typical electrical schematic



Filter selection table

Filter*	Rated current	Typical drive	Leakage current***	Power loss	Input/Output connections		Weight
	@ 40°C (25°C)	power rating**	@ 440/520 VAC/50 Hz	@ 25°C/50 Hz			
	[A]	[kW]	[mA]	[W]			[kg]
FN 351-8-29	8 (9.2)	3	0.3	7	-29		0.8
FN 351-16-29	16 (18.5)	5.5	0.3	8	-29		1.3
FN 351-25-33	25 (28.9)	11	3.2	8	-33		1.4
FN 351-36-33	36 (41.6)	15	3.2	9	-33		1.5
FN 351-50-..	50 (57.7)	22	3.5	11	-33		1.6
FN 351-64-..	64 (73.9)	30	3.5	15	-33	-34	1.7
FN 351-80-34	80 (92.3)	37	3.7	23	-34		5.6
FN 351-110-35	110 (127)	55	3.7	25	-35		5.8
FN 351-180-36	180 (208)	90	3.7	49	-36		13.0
FN 351-280-37	280 (323)	132	4.3	70	-37		28.0
FN 351 H-8-29	8 (9.2)	4	0.3	7	-29		1.1
FN 351 H-16-29	16 (18.5)	7.5	0.3	8	-29		1.3
FN 351 H-25-33	25 (28.9)	15	3.8	8	-33		1.4
FN 351 H-36-33	36 (41.6)	18.5	3.8	9	-33		1.5
FN 351 H-50-..	50 (57.7)	30	3.8	11	-33		1.6
FN 351 H-64-33	64 (73.9)	37	3.8	15	-33		1.7
FN 351 H-80-34	80 (92.3)	45	4.4	23	-34		5.6
FN 351 H-110-35	110 (127)	75	4.4	25	-35		5.8
FN 351 H-180-36	180 (208)	110	4.4	49	-36		13.0

* To compile a complete part number, please replace the .. with the required I/O connection style.
 ** Calculated at rated current, 400 VAC (FN 351)/480 VAC (FN 351 H) and cos phi=0.8. The exact value depends upon the efficiency of the drive, the motor and the entire application.
 *** Standardized calculated leakage current acc. IEC60939 under normal operating conditions (FN 351 at 440 VAC and FN 351H at 520 VAC).

Typical filter attenuation

Per CISPR 17; A=50 Ω/50 Ω sym; B=50Ω/50Ω asym; C=0.1 Ω/100 Ω sym; D=100 Ω/0.1 Ω sym

8 A types

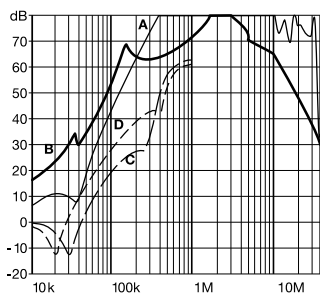

16 A types

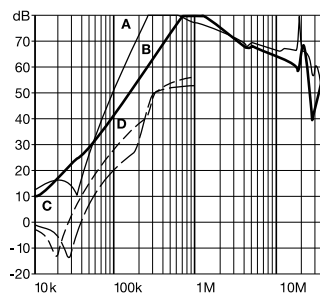

25 A types

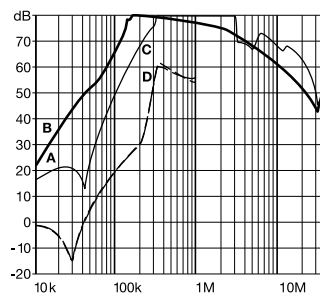

36 and 50 A types

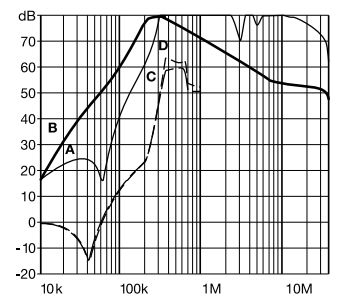

64 A types

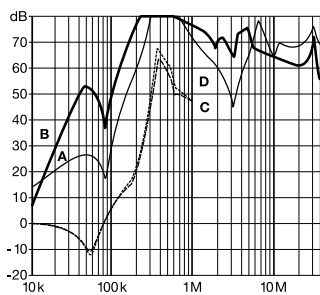

80 and 110 A types

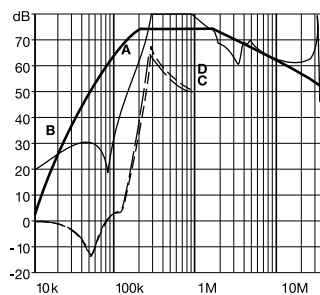

180 A types

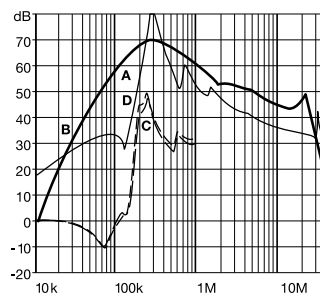

280 A types

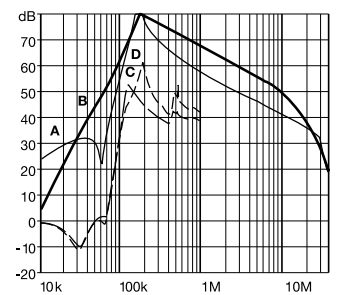

Mechanical data

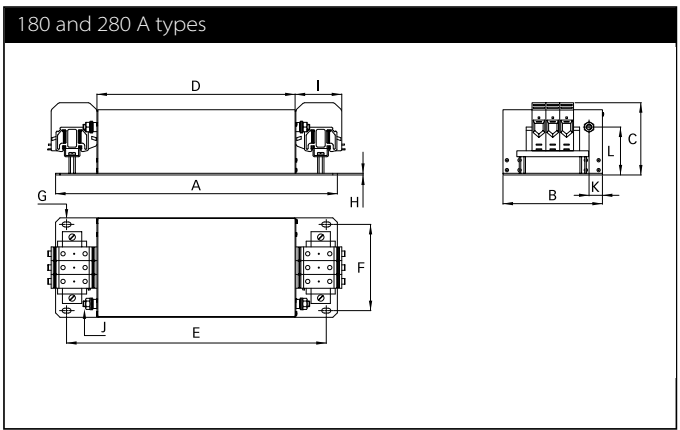
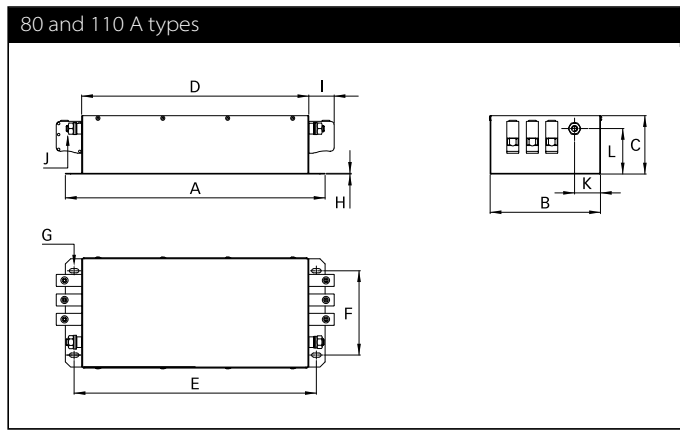
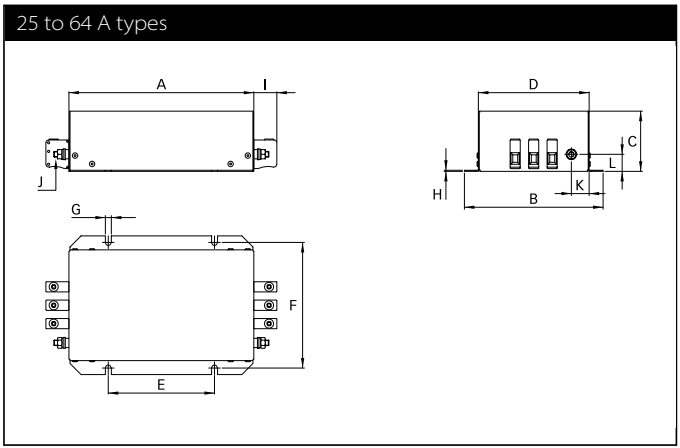
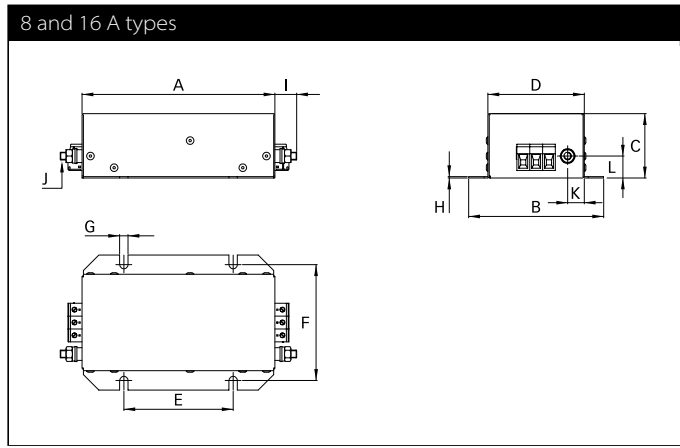







Dimensions

	8 A	8 A (-H)	16 A	25 A	36 A	50 A (-33)	50 A (-34)	64 A (-33)	64 A (-34)	80 A	110 A	180 A	280 A
A	180	200	200	200	200	200	200	200	200	400	400	510	700
B	115	150	150	150	150	150	150	150	150	170	170	180	260
C	60	65	65	65	65	65	65	65	80	90	90	133	155
D	85	120	120	120	120	120	120	120	120	350	350	360	530
E	115	115	115	115	115	115	115	115	115	373	373	470	660
F	100	136	136	136	136	136	136	136	136	130	130	156	220
G	6.5	6.5	6.5	6.5	6.5	6.5	6.5	6.5	6.5	15 x 6.5	15 x 6.5	16 x 9	16 x 9
H	1	1	1	1	1	1	1	1	1	1	1	4	4
I	17	17	17	25	25	25	39	25	39	39	45	83	110
J	M6	M6	M6	M6	M6	M6	M6	M6	M6	M10	M10	M10	M10
K	13	19.25	19.25	19.25	19.25	19.25	18.75	19.25	18.75	40	40	25	30
L	17	17	17	18.4	18.4	18.4	17	18.4	17	70	70	85	100

All dimensions in mm; 1 inch = 25.4 mm
Tolerances according: ISO 2768-m / EN 22768-m

Filter input/output connector cross sections

	-29	-33	-34	-35	-36	-37
						
Solid wire	6 mm ²	16 mm ²	35 mm ²	50 mm ²	95 mm ²	150 mm ²
Flex wire	4 mm ²	10 mm ²	25 mm ²	50 mm ²	95 mm ²	150 mm ²
AWG type wire	AWG 10	AWG 6	AWG 2	AWG 1/0	AWG 4/0	AWG 6/0
Recommended torque	0.6-0.8 Nm	1.5-1.8 Nm	4.0-4.5 Nm	7-8 Nm	17-20 Nm	27-30 Nm

Please visit www.schaffner.com to find more details on filter connectors.



Headquarters, global innovation and development

Switzerland

Schaffner Group

Industrie Nord
Nordstrasse 11e
4542 Luterbach
T +41 32 681 66 26
info@schaffner.com



Sales and application centers

China

Schaffner EMC Ltd. Shanghai

T20-3 C, No 565 Chuangye Road,
Pudong district
201201 Shanghai
T +86 21 3813 9500
cschina@schaffner.com
www.schaffner.com.cn

Finland

Schaffner Oy

Sauvonrinne 19 H
08500 Lohja
T +358 10 567 2855
finlandsales@schaffner.com

France

Schaffner EMC S.A.S.

16-20 Rue Louis Rameau
95875 Bezons
T +33 1 34 34 30 60
F +33 1 39 47 02 28
francesales@schaffner.com

Germany

Schaffner Deutschland GmbH

Schoemperlenstrasse 12B
76185 Karlsruhe
T +49 721 56910
F +49 721 569110
germanysales@schaffner.com

India

Schaffner India Pvt. Ltd

REGUS WORLD TRADE CENTRE
WTC, 22nd Floor Unit No 2238, Brigade
Gateway Campus, 26/1, Dr. Rajkumar Road
Malleshwaram (W)
560055 Bangalore
T +91 80 67935355
indiasales@schaffner.com

Italy

Schaffner EMC S.r.l.

Via Ticino, 30
20900 Monza (MB)
T +39 039 21 41 070
italysales@schaffner.com

Japan

Schaffner EMC K.K.

Taiju-Seimei Sangenjaya Bldg.
1-32-12, Kamiuma, Setagaya-ku
154-0011 Tokyo
T +81 3 5712 3650
F +81 3 5712 3651
japansales@schaffner.com
www.schaffner.jp

Singapore

Schaffner EMC Pte Ltd.

#05-09, Kg Ubi Ind. Estate
408705 Singapore
T +65 6377 3283
F +65 6377 3281
singaporesales@schaffner.com

Spain

Schaffner EMC España

Calle Caléndula 93, Miniparc III, Edificio E
El Soto de Moraleja, Alcobendas
28109 Madrid
T +34 917 912 900
F +34 917 912 901
spainsales@schaffner.com

Sweden

Schaffner EMC AB

Östermalmstorg 1
114 42 Stockholm
T +46 8 5050 2425
swedensales@schaffner.com
www.schaffner.com

Switzerland

Schaffner EMV AG

Industrie Nord
Nordstrasse 11e
4542 Luterbach
T +41 32 681 66 26
switzerlandsales@schaffner.com

Taiwan R.O.C.

Schaffner EMV Ltd.

20 Floor-2, No 97, Section 1, XinTai 5th Road
22175 XiZhi District New Taipei City 22175
T +886 2 2697 5500
F +886 2 2697 5533
taiwansales@schaffner.com
www.schaffner.com.tw

Thailand

Schaffner EMC Co. Ltd.

Northern Region Industrial Estate
67 Moo 4 Tambon Ban Klang
Amphur Muangng P.O. Box 14
51000 Lamphun
T +66 53 58 11 04
F +66 53 58 10 19
thailandsales@schaffner.com

United Kingdom

Schaffner Ltd.

5 Ashville Way, Molly Millars Lane
Wokingham
RG41 2PL Berkshire
T +44 118 9770070
F +44 118 9792969
uksales@schaffner.com

USA

Schaffner EMC Inc.

52 Mayfield Avenue
Edison, New Jersey
T +1 732 225 9533
F +1 732 225 4789
usasales@schaffner.com
www.schaffnerusa.com

Schaffner North America

6722 Thirlane Road
24019 Roanoke, Virginia
T +1 276 228 7943
F +1 276 228 7953

Schaffner North America

823 Fairview Road
24382 Wytheville, Virginia
T +1 276 228 7943
F +1 276 228 7258

To find your local partner within Schaffner's global network: www.schaffner.com

© 2018 Schaffner Group

The content of this document has been carefully checked and understood. However, neither Schaffner nor its subsidiaries assume any liability whatsoever for any errors or inaccuracies of this document and the consequences thereof. Published specifications are subject to change without notice. Product suitability for any area of application must ultimately be determined by the customer. In all cases, products must never be operated outside their published specifications. Schaffner does not guarantee the availability of all published products. This disclaimer shall be governed by substantive Swiss law and resulting disputes shall be settled by the courts at the place of business of Schaffner Holding AG. Latest publications and a complete disclaimer can be downloaded from the Schaffner website. All trademarks recognized.