

16300/16700

Rectangular or square caps • distinct tactile feel • many legend options



DISTINCTIVE FEATURES

Rectangular cap : 6 x 12.3 mm; h=16.9 mm

Square cap : 14.9 x 14.9 mm; h=14.6 mm

Many standard legends options

Many functions incl quiet with Unimec™ switches

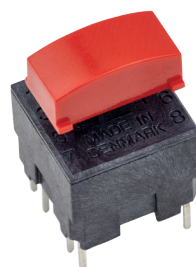

SWITCH SPECIFICATIONS : see Unimec™ series.

UNIMEC™+16300

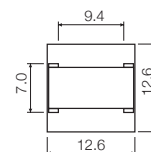
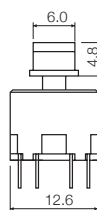
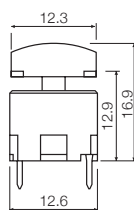

UNIMEC™+16700

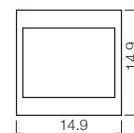
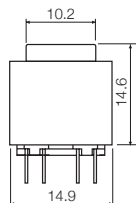
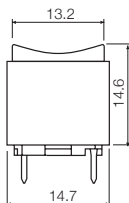

16300/16700

Rectangular or square caps • distinct tactile feel • many legend options



BUILD YOUR PART NUMBER

NON-ILLUMINATED

15

SERIES

FUNCTION

CAP

COLOR

| | |
|-----|------------------------|
| 400 | momentary quiet silver |
| 401 | momentary silver |
| 402 | momentary gold |
| 420 | momentary quiet gold |
| 451 | latching silver |
| 452 | latching gold |

| |
|-------|
| 16300 |
| 16700 |

| | |
|----|--------|
| 00 | blue |
| 02 | green |
| 03 | grey |
| 04 | yellow |
| 06 | white |
| 08 | red |
| 09 | black |



MOUNTING

- Panel cut-out :
16300 : min. 12.7 x 6.4 mm
16700 : min. 15.3 x 15.3 mm
- Switch spacing AxB :
16300 : min. 13 x 13 mm
16700 : min. 15.5 x 15.5 mm



MATERIALS

- Cap : ABS UL94HB

Legends and solid colors

Available for Unimec caps



STANDARD LEGENDS

| STANDARD LEGENDS | | |
|------------------|--------------|--------------|
| LEGEND | 16300 18_ | 16700 18_ |
| 0 | 000 | 200 |
| 1 | 001 | 201 |
| 2 | 002 | 202 |
| 3 | 003 | 203 |
| 4 | 004 | 204 |
| 5 | 005 | 205 |
| 6 | 006 | 206 |
| 7 | 007 | 207 |
| 8 | 008 | 208 |
| 9 | 009 | 209 |
| → | 033 | 233 |
| ↑ | 034 | 234 |

All standard legends are white on black caps.

The size of the legends listed may not correspond to the actual size.

Custom legends and other color combinations are available, please ask APEM or your local distributor, if you do not find what you need on the list.



SOLID COLORS

| CAP | CODE | Colour / RAL Code | | | | | | | |
|-------|------|-------------------|--------------|-------------|---------------|--------------|------------|--------------|--|
| | | Blue / 5012 | green / 6018 | Grey / 7004 | Yellow / 1023 | White / 9010 | Red / 3000 | Black / 9004 | |
| | | | | | | | | | |
| | | 00 | 02 | 03 | 04 | 06 | 08 | 09 | |
| 16300 | | • | • | • | • | • | • | • | |
| 16700 | | • | • | • | • | • | • | • | |
| 16310 | | • | • | • | • | • | • | • | |
| 16311 | | | | • | | | • | • | |
| 16312 | | | | • | | | • | • | |
| 16314 | | | | • | | | • | • | |
| 16315 | | | | • | | | • | • | |
| 16324 | | | | • | | | | • | |
| 16325 | | | | • | | | | • | |
| 16326 | | | | • | | | | • | |

The RAL Codes mentioned are the codes nearest to the solid colors in the multimec™ range.

Unimec™

8 contact functions •
2 pole • distinct tactile feel

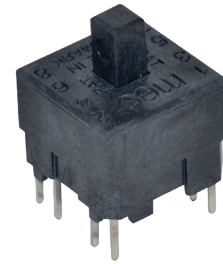

DISTINCTIVE FEATURES

12.6 x 12.6 mm; h=15.7 mm

2 pole

Momentary, latching or quiet

8 contact functions

Up to 10,000,000 cycle lifetime



ENVIRONMENTAL SPECIFICATIONS

- Sealing : IP54 according to IEC 60529
- Working temperature : -40 °C/+160 °C
- Storage temperature : -65 °C/+160 °C
- Soldering : IEC 68-2-20



ELECTRICAL SPECIFICATIONS

- Recommended load :
 - Gold contacts : min. 0.5 μ A - max.250 mA - 120 V - 9 W AC - 6 W DC
 - Silver contacts : min. 0.5 mA - max.250 mA - 120 V - 9 W AC - 6 W DC
- Contact resistance : max. 100 m Ω (initially)
- Insulation resistance : >10 M Ω
- Contact bounce : max. 10 ms
- Dielectric strength between adjacent contacts : 1000 V for 2 min
- Insulation resistance between adjacent contacts : 5 X 10¹³ Ω
- Capacitance between adjacent contacts :0.5 pF



MECHANICAL SPECIFICATIONS

- Standard actuation force : 2.5 N
- Max. actuation force : 100 N for 10 sec
- Travel : 1.8 mm
- Lifetime :
 - momentary : >10,000,000 cycles
 - latching : 5,000,000 cycles

The company reserves the right to change specifications without notice.

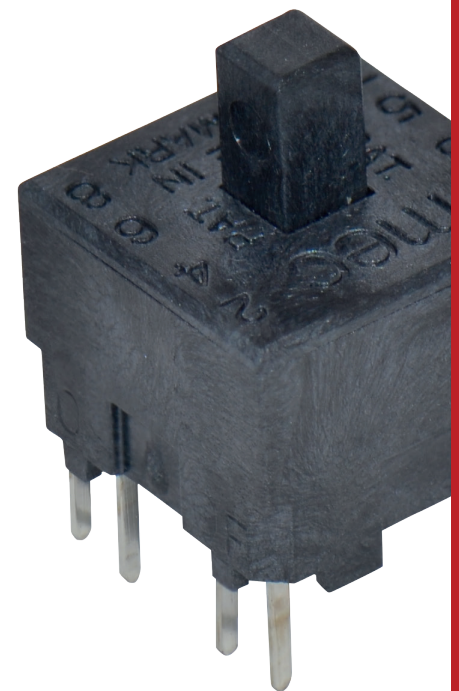

MATERIALS

- Housing : LCP UL94V0
- Actuator : LCP UL94V0
- Switch spring : Stainless steel
- Key spring : Stainless steel
- Latch pin : Stainless steel
- Fixed contacts :
 - Silver : SnCu + 2 μ Ni + 3 μ Ag
 - Gold : SnCu + 2 μ Ni + 3 μ Au
- Moving contacts :
 - Silver : Stainless steel + 3 μ Ag
 - Gold : Stainless steel + 3 μ Ag + 1 μ Au
- Terminals : SnCu + 2 μ Ni + 3 μ Sn100

All tolerance if not otherwise specified \pm 0.2mm.

Unimec™

8 contact functions •
2 pole • distinct tactile feel

UNIMEC

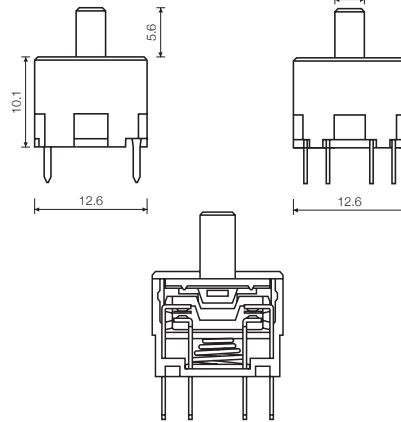
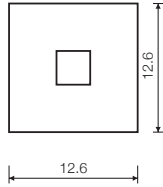
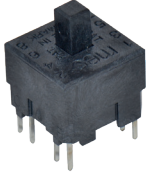

- TH
- momentary, latching or quiet
- 8 contact functions

All tolerances unless otherwise noted : ±0.2 mm



PCB LAYOUT

PCB MOUNTING HOLE DIMENSIONS

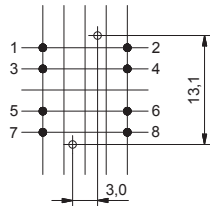
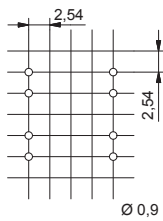

With 3 mm LED
16923 and 16924

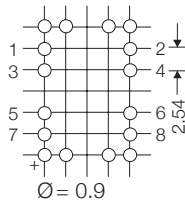

With round LED
16920 and 16921

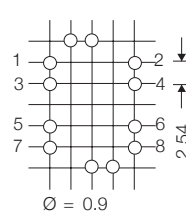

With square LED
16922

FUNCTIONAL DIAGRAM

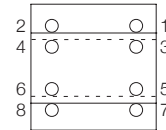

- up
-- down

CIRCUIT DIAGRAM

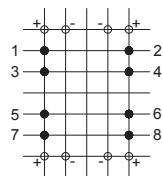
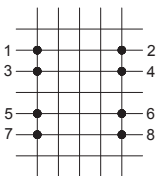

With round LED
16920 and 16921

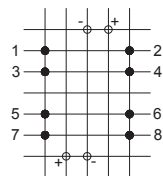

With rect LED
16922



WIRING

Select the contact function you require - and design your PC board accordingly

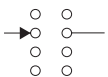

1 make contact

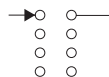

1 break contact

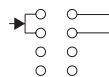

1 change
over contact

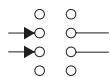

2 make contact

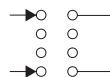

2 break contact

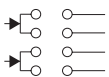

2 change
over contact

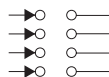

2 make
& 2 break

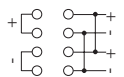

reverse polarity



BUILD YOUR PART NUMBER

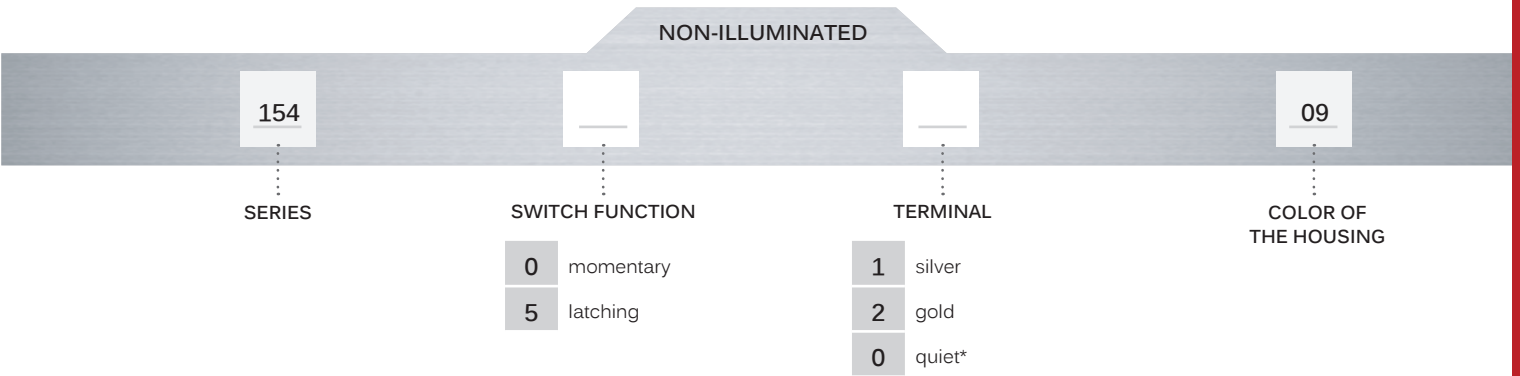

*quiet function has silver terminals, in case of gold terminals the part number is 15420



ABOUT THIS SERIES

- Notice** : please note that not all combinations of above numbers are available. Contact APEM for further information.
- Marking on the switch for identification** : 15400 A; 15420 H; 15401 E; 15402 F; 15451 I; 15452 J
- Accessories** : See www.apem.com for cap & bezel options.

Unimec™

8 contact functions •
2 pole • distinct tactile feel



VARIO SUPPORT MOUNTING

For all types of Unimec™ switches with bezels - 16310 - 16315 and 16324 - 16326.
More options available as custom.

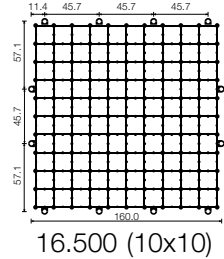
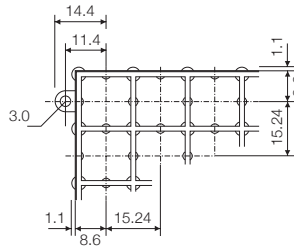
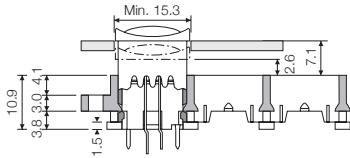

16.500 (10x10)



16.410 (1x1)



16.412 (1x3)

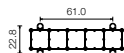

16.414 (1x5)

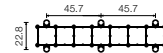

16.416 (1x7)

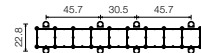

16.418 (1x9)



16.411 (1x2)



16.413 (1x4)

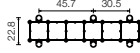

16.415 (1x6)

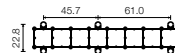

16.417 (1x8)

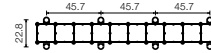

16.419 (1x10)



16.420 (2x2)



16.430 (3x3)

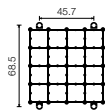

16.440 (4x4)

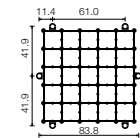

16.450 (5x5)

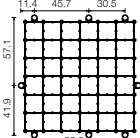

16.460 (6x6)

LED COMPONENT SPECIFICATIONS

| Part Nos. | 16920/16921 | | | 16922 | | | 16923 | | | | 16924 | | | | |
|--|--|---------------------|-----|-------|---------------------|-----|-------|---------------------|------|------|-------|---------------------|---------|---------|---------|
| | G | Y | R | G | Y | R | B | G | Y | W | R | G | Y | R | |
| Color (G=green, Y=yellow, R=red) | G | Y | R | G | Y | R | B | G | Y | W | R | G | Y | R | |
| Color Codes | 02 | 04 | 08 | 02 | 04 | 08 | 00 | 20 | 40 | 65 | 80 | 23 | 45 | 88 | |
| ABSOLUTE MAXIMUM RATINGS (Ta=25°C) | | | | | | | | | | | | | | | |
| Power | mW | 100 | 100 | 100 | 135 | 135 | 135 | 105 | 70 | 60 | 120 | 60 | 150 | 130 | 300 |
| Current forward | mA | 30 | 30 | 30 | 30 | 30 | 30 | 30 | 20 | 20 | 25 | 20 | 40 | 40 | 90 |
| Forward peak current | mA | 50 | 50 | 50 | 90 | 90 | 90 | 200 | 60** | 60** | 100 | 60** | 500 | 500 | 1000 |
| Voltage reverse | V | 5 | 5 | 5 | 5 | 5 | 5 | 5 | 3 | 3 | 5 | 3 | 12 | 12 | 5 |
| Operating temperature | °C | -25 / +100 | | | -55 / +100 | | | -25 / +85 | | | | -55 / +100 | | | |
| Storage temperature | °C | -25 / +100 | | | -55 / +100 | | | -30 / +100 | | | | -55 / +100 | | | |
| Soldering temperature | °C | +245 for max. 3 sec | | | +300 for max. 3 sec | | | +260 for max. 5 sec | | | | +300 for max. 3 sec | | | |
| ELECTRICAL-OPTICAL CHARACTERISTICS (Ta=25°C) | | | | | | | | | | | | | | | |
| Voltage forward | Typ. V | 2.0 | 2.0 | 2.0 | 2.1 | 2.2 | 2.3 | 2.1 | 2.1 | 2.1 | 3.8 | 2.0 | 2.1* | 2.3*** | 2.4*** |
| | Max. V | 3.0 | 3.0 | 3.0 | 3.0 | 3.0 | 3.0 | 2.8 | 3.0 | 3.0 | 4.3 | 3.0 | 2.5* | 2.5*** | 3.8*** |
| Current reverse | µA | 100 | 100 | 100 | 100 | 100 | 100 | 2 | 10 | 10 | 50 | 10 | 10 | 10 | 10 |
| Wave length | nm | 560 | 590 | 660 | 565 | 585 | 635 | 460 | 563 | 585 | NA | 650 | 570 | 587 | 635 |
| Spread | Ønm | 10 | 10 | 10 | 10 | 10 | 10 | 40 | 40 | 40 | NA | 40 | 25 | 45 | 45 |
| Spread angle | degree | 20 | 20 | 20 | 45 | 45 | 45 | 20 | 45 | 45 | 25 | 45 | 25 | 45 | 45 |
| Luminous Intensity | Min. mcd | 1 | 1 | 0.8 | 1.5 | 2.5 | 2.5 | 20 | 9.0 | 5.6 | 630 | 5.6 | 71**** | 71**** | 100**** |
| | Typ. mcd | 2 | 3 | 1.6 | 2.5 | 3.0 | 5.0 | 25 | 25 | 16 | 1000 | 16 | 112**** | 112**** | 160**** |
| Orientation | The longer pin is the anode, the shorter is the cathode. | | | | | | | | | | | | | | |

*I_F=20mA, **Pulse width 1ms Duty cycle 1:5, ***I_F=50mA, ****Luminous Flux mlm



USAGE GUIDELINES

HOW TO GET THE BEST RESULTS WITH MEC SWITCHES ?

These guidelines are offered to users of MEC Switches as an aid to ensure successful and reliable switch operation. Please see the technical specifications for details on operating and storage temperatures and soldering guidelines to make sure you select the best switch for your application. When wave soldering is taking place, MEC strongly recommends that the temperature profile is analyzed and compared with the temperature rating of the switch. It is also important to monitor the accumulated heat buildup from both the pre-heat zones and the solder zone.

All standard accessories for unimec™ switches are made from ABS plastic with a maximum operating temperature of 65°C. It is strongly recommended that accessories are mounted after soldering of the switch.

LEDs have their own temperature specifications. When fitted in a switch the LED will determine the max. operating temperature, i.e. 16923 has an upper temperature limit of 85°C!

MOUNTING AND DISMOUNTING

If switches are to be mounted in rows it is essential that the recommendations regarding spacing are followed. PC board thickness should be 1.4±0.2 mm and terminal hole diameter should be 0.9 mm.

All unimec™ caps and bezels are easily snapped onto the switch modules and can be changed at a later time with the exception of the unimec 16.700 cap. Once this cap is installed it is not designed to be removed. To do so may cause damage to the switch and the PC board if not done very carefully.

If the 16.300 or 16.700 cap must be removed from a unimec™ latching switch, make sure that the switch actuator is in the released, upper position before attempting to remove the cap. This will prevent possible damage to the internal latching pin.

SOLDERING AND CLEANING UNIMEC™ SERIES

Most assembly and field problems experienced by users of unsealed switches are caused by the contamination of the contacts during soldering and cleaning.

Contact contamination may be recognized by an increase in contact resistance and possible intermittent operation of the switch, especially in low power applications. Care must be taken not to submerge the switch in cleaning agents or

spray the switch during cleaning. The switch must be protected at all times to prevent contamination by flux or cleaning liquids.

For unimec™ latching versions we recommend to leave the actuator in the released upper position during soldering. This makes the switch more resistant to overheating.

SOLDERING - THROUGH HOLE VERSIONS

Hand soldering: Max. 350°C for max. 3 sec.

Wave soldering: Heat built up in the switch during pre-heating and soldering must not exceed the maximum operating temperature of the switch. Peak temperature must not exceed 260°C, and soldering time is max 10 sec. (IEC-68-2-20)

ROHS COMPLIANCE

As of 1 July 2006 MEC has completed the conversion to RoHS compliance. For more info please see our homepage www.apem.com

TEMPERATURE LIMITS:

| | |
|-------------|-----------|
| Switch | 160 °C |
| LEDs | 85/100 °C |
| Accessories | 65 °C |

PACKAGING

Unimec™ switches are packed in rigid tubes of 50 pieces each.

A box contains 1.000 pcs.