

C4C, Film, Metallized Polypropylene, Power, 0.33 uF, 5%, 630 VAC, 2000 VDC, 70°C

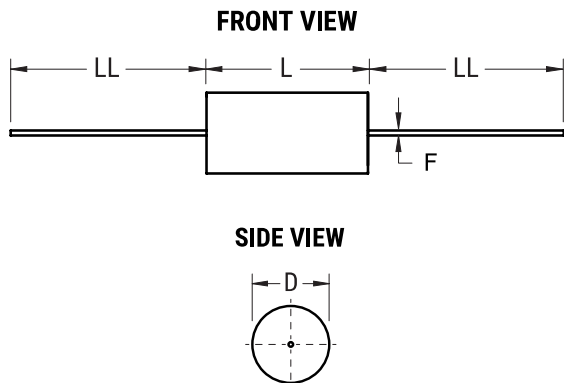

Dimensions	
D	28.5mm NOM
L	44mm NOM
LL	40mm +/-5mm
F	1.2mm NOM

Packaging Specifications	
Packaging:	Bulk, Bag
Packaging Quantity:	50

General Information	
Supplier:	KEMET
Series:	C4C
Dielectric:	Metallized Polypropylene
Style:	Axial
RoHS:	Yes
Lead:	Wire Leads
Miscellaneous:	Polyester Tape & Resin Protection

Specifications	
Capacitance:	0.33 uF
Capacitance Tolerance:	5%
Voltage AC:	630 VAC
Voltage DC:	2000 VDC
Temperature Range:	-40/+85C
Rated Temperature:	70°C
Dissipation Factor:	0.05%
Max dV/dt:	700 V/us
Resistance:	5.9 mOhms (100kHz)
Ripple Current:	12 Amps (100kHz 70C), 231 Amps (Peak)