

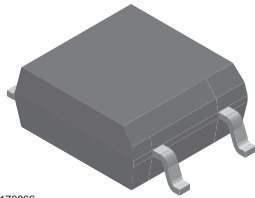

## Optocoupler, Phototriac Output, Non-Zero Crossing, 1.5 kV/ $\mu$ s dV/dt, 600 V

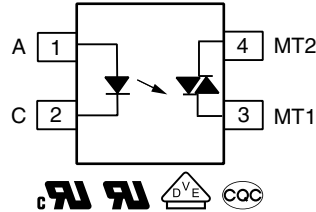

1179066



### FEATURES

- High static dV/dt > 1.5 kV/ $\mu$ s
- Input sensitivity  $I_{FT} = 5$  mA and 10 mA
- On-state RMS current  $I_{T(RMS)} = 70$  mA
- 600 V peak off-state blocking voltage
- Isolation test voltage 3750 V<sub>RMS</sub>
- Material categorization: for definitions of compliance please see [www.vishay.com/doc?99912](http://www.vishay.com/doc?99912)



### LINKS TO ADDITIONAL RESOURCES



### APPLICATIONS

- Consumer appliances
- Triac drives
- Solid-state relays
- Industrial controls
- Office equipment
- Lighting controls

### DESCRIPTION

The VOM3052 and VOM3053 phototriac consist a GaAs IRLED optically coupled to a photosensitive non-zero crossing TRIAC packaged in a SOP-4 package. It has a LED trigger current of 5 mA for VOM3053 and 10 mA for VOM3052.

The VOM3052 and VOM3053 phototriac isolate low-voltage logic from 120 V<sub>AC</sub>, 240 V<sub>AC</sub>, and 380 V<sub>AC</sub> lines to control resistive, inductive, or capacitive loads including motors, solenoids, high current thyristors or TRIAC and relays.

### AGENCY APPROVALS

- [UL](#)
- [cUL](#)
- [DIN EN 60747-5-5 \(VDE 0884-5\)](#), available with option 1
- [CQC GB4943.1](#)

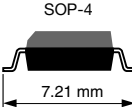
ORDERING INFORMATION		
<div style="display: flex; justify-content: space-around; align-items: center;"> <div style="border: 1px solid black; padding: 2px 5px; margin: 2px;">V</div> <div style="border: 1px solid black; padding: 2px 5px; margin: 2px;">O</div> <div style="border: 1px solid black; padding: 2px 5px; margin: 2px;">M</div> <div style="border: 1px solid black; padding: 2px 5px; margin: 2px;">3</div> <div style="border: 1px solid black; padding: 2px 5px; margin: 2px;">0</div> <div style="border: 1px solid black; padding: 2px 5px; margin: 2px;">5</div> <div style="border: 1px solid black; padding: 2px 5px; margin: 2px;">X</div> <div style="border: 1px solid black; padding: 2px 5px; margin: 2px;">T</div> </div> <p style="text-align: center; margin-top: 5px;">PART NUMBER</p>		
AGENCY CERTIFIED / PACKAGE	TRIGGER CURRENT $I_{FT}$	
UL, cUL, CQC	5 mA	10 mA
SOP-4	VOM3053T	VOM3052T
SOP-4 180° orientation	VOM3053T3	-
VDE, UL, cUL, CQC	5 mA	10 mA
SOP-4	VOM3053-X001T	VOM3052-X001T

### Notes

- For additional information on the available options refer to option information
- The product is available only on tape and reel



ABSOLUTE MAXIMUM RATINGS (T <sub>amb</sub> = 25 °C, unless otherwise specified)					
PARAMETER	TEST CONDITION	PART	SYMBOL	VALUE	UNIT
<b>INPUT</b>					
Reverse voltage			V <sub>R</sub>	6	V
Forward current			I <sub>F</sub>	60	mA
Peak surge current	100 μs, 200 pps		I <sub>FSM</sub>	0.5	A
Power dissipation			P <sub>diss</sub>	100	mW
<b>OUTPUT</b>					
Peak off-state voltage			V <sub>DRM</sub>	600	V
RMS on-state current			I <sub>T(RMS)</sub>	70	mA
Peak non-repetitive surge current	PW = 100 ms, 120 pps		I <sub>TSM</sub>	1	A
Power dissipation			P <sub>diss</sub>	200	mW
<b>COUPLER</b>					
Isolation test voltage	t = 1 min		V <sub>ISO</sub>	3750	V <sub>RMS</sub>
Power dissipation			P <sub>tot</sub>	300	mW
Storage temperature range			T <sub>stg</sub>	-55 to +150	°C
Ambient temperature range			T <sub>amb</sub>	-40 to +100	°C
Soldering temperature			T <sub>sld</sub>	260	°C

Notes

- Stresses in excess of the Absolute Maximum Ratings can cause permanent damage to the device. Functional operation of the device is not implied at these or any other conditions in excess of those given in the operational sections of this document. Exposure to Absolute Maximum Ratings for extended periods of the time can adversely affect reliability.

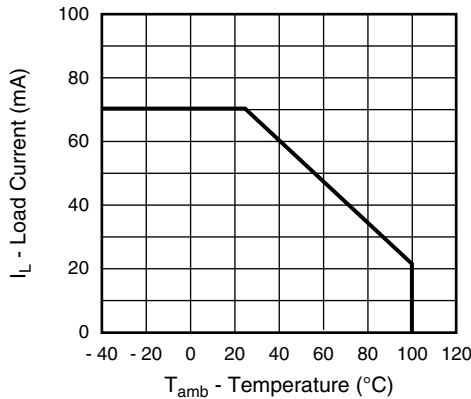

Fig. 1 - Recommended Operating Condition



ELECTRICAL CHARACTERISTICS (T <sub>amb</sub> = 25 °C, unless otherwise specified)							
PARAMETER	TEST CONDITION	PART	SYMBOL	MIN.	TYP.	MAX.	UNIT
<b>INPUT</b>							
Forward voltage	I <sub>F</sub> = 10 mA		V <sub>F</sub>	-	1.2	1.5	V
Reverse current	V <sub>R</sub> = 6 V		I <sub>R</sub>	-	-	10	μA
Input capacitance	V <sub>F</sub> = 0 V, f = 1 MHz		C <sub>I</sub>	-	25	-	pF
<b>OUTPUT</b>							
Off-state current	V <sub>D</sub> = V <sub>DRM</sub>		I <sub>DRM</sub>	-	-	100	nA
On-state voltage	I <sub>T</sub> = 100 mA		V <sub>TM</sub>	-	-	3	V
Critical rate of rise off-state voltage	V <sub>D</sub> = 0.67 V <sub>DRM</sub> , T <sub>J</sub> = 25 °C		dV/dt <sub>cr</sub>	1500	-	-	V/μs
Critical rate of rise of voltage at current commutation			dV/dt <sub>crq</sub>	-	0.13	-	V/μs
<b>COUPLER</b>							
LED trigger current, current required to latch output	V <sub>D</sub> = 3 V	VOM3053	I <sub>FT</sub>	-	-	5	mA
		VOM3052	I <sub>FT</sub>	-	-	10	mA
Capacitance (input - output)	f = 1 MHz, V <sub>IO</sub> = 0 V		C <sub>IO</sub>	-	0.8	-	pF
Peak off-state voltage	I <sub>C</sub> = 100 μA		V <sub>DRM</sub>	600	-	-	V
Holding current			I <sub>hold</sub>	-	0.3	-	mA

**Note**

- Minimum and maximum values were tested requirements. Typical values are characteristics of the device and are the result of engineering evaluations. Typical values are for information only and are not part of the testing requirements.

SAFETY AND INSULATION RATINGS						
PARAMETER	SYMBOL	MIN.	TYP.	MAX.	UNIT	
Climatic classification (according to IEC 68 part 1)		-	40 / 100 / 21	-		
Pollution degree (DIN VDE 0109)		-	2	-		
Comparative tracking index	CTI	175	-	399		
Peak transient overvoltage	V <sub>IOTM</sub>	-	-	6000	V <sub>peak</sub>	
Peak insulation voltage	V <sub>IORM</sub>	-	-	707	V <sub>peak</sub>	
Isolation resistance at T <sub>amb</sub> = 100 °C, V <sub>DC</sub> = 500 V	R <sub>IO</sub>	10 <sup>11</sup>	-	-	Ω	
Isolation resistance at T <sub>amb</sub> = 25 °C, V <sub>DC</sub> = 500 V	R <sub>IO</sub>	10 <sup>12</sup>	-	-	Ω	
Safety rating - power	P <sub>SO</sub>	-	-	400	mW	
Safety rating - input current	I <sub>SI</sub>	-	-	150	mA	
Safety rating - temperature	T <sub>SI</sub>	-	-	165	°C	
Creepage distance		5	-	-	mm	
Clearance distance		5	-	-	mm	
Insulation thickness	DTI	0.4	-	-	mm	



TYPICAL CHARACTERISTICS (T<sub>amb</sub> = 25 °C, unless otherwise specified)

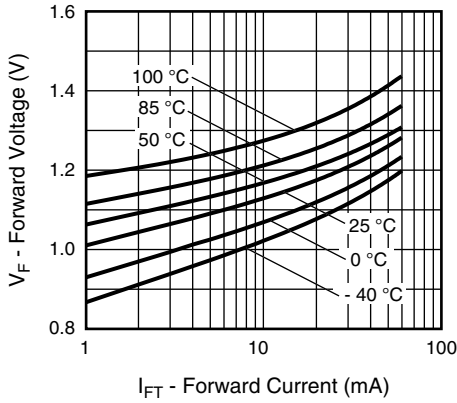

Fig. 2 - Forward Current vs. Forward Voltage

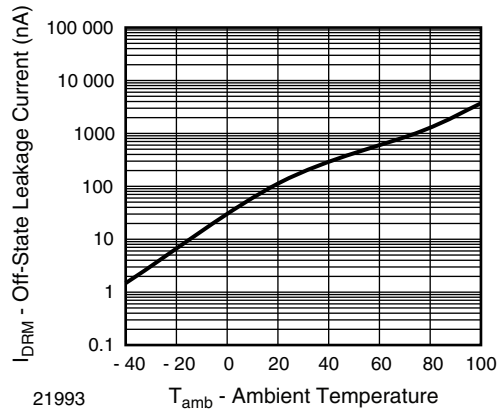

Fig. 5 - Off-State Leakage Current vs. Ambient Temperature

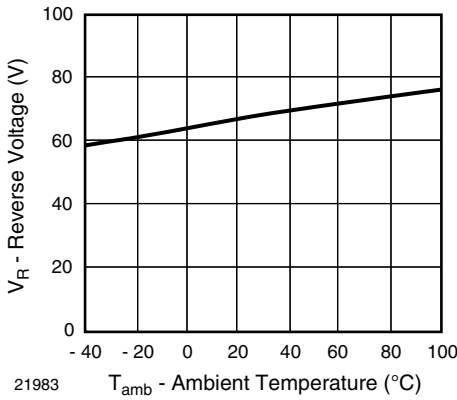

Fig. 3 - Reverse Voltage vs. Ambient Temperature

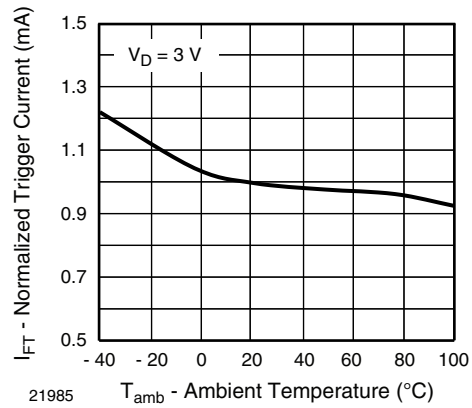

Fig. 6 - Normalized Trigger Current vs. Ambient Temperature

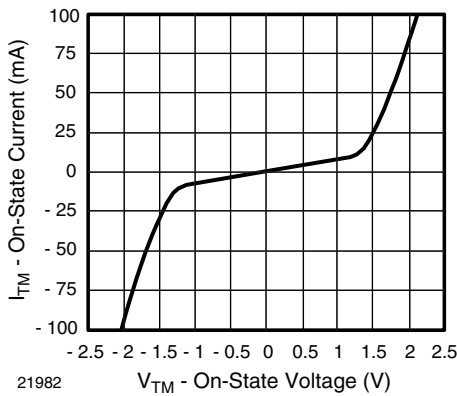

Fig. 4 - On-State Current vs. On-State Voltage

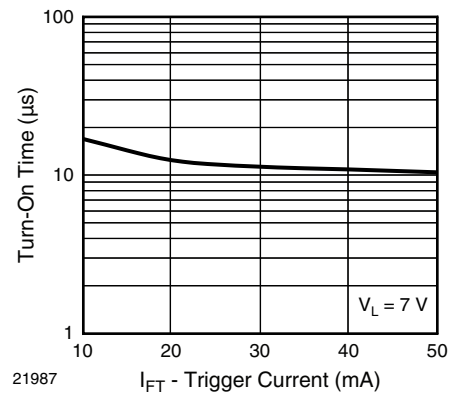

Fig. 7 - Trigger Current vs. Turn-On Time

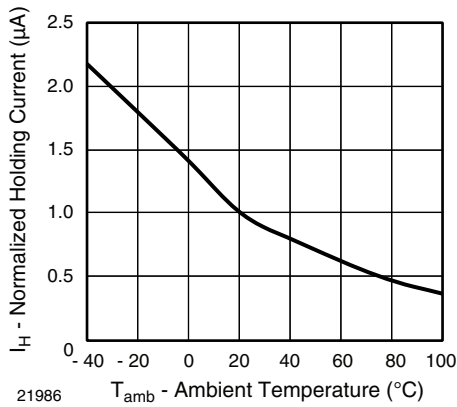

Fig. 8 - Normalized Holding Current vs. Ambient Temperature

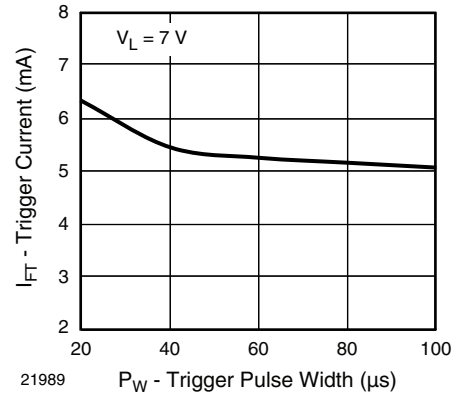

Fig. 10 - Trigger Current vs. Trigger Pulse Width

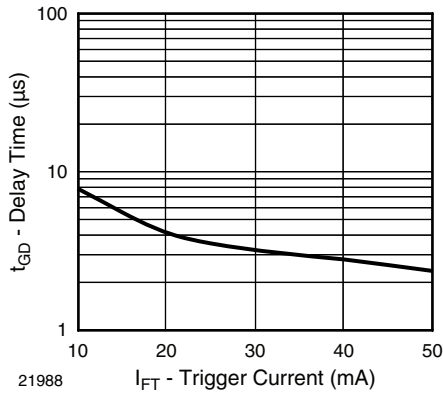

Fig. 9 - Trigger Current vs. Delay Time

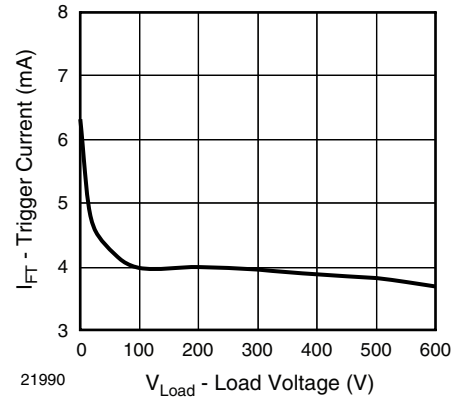
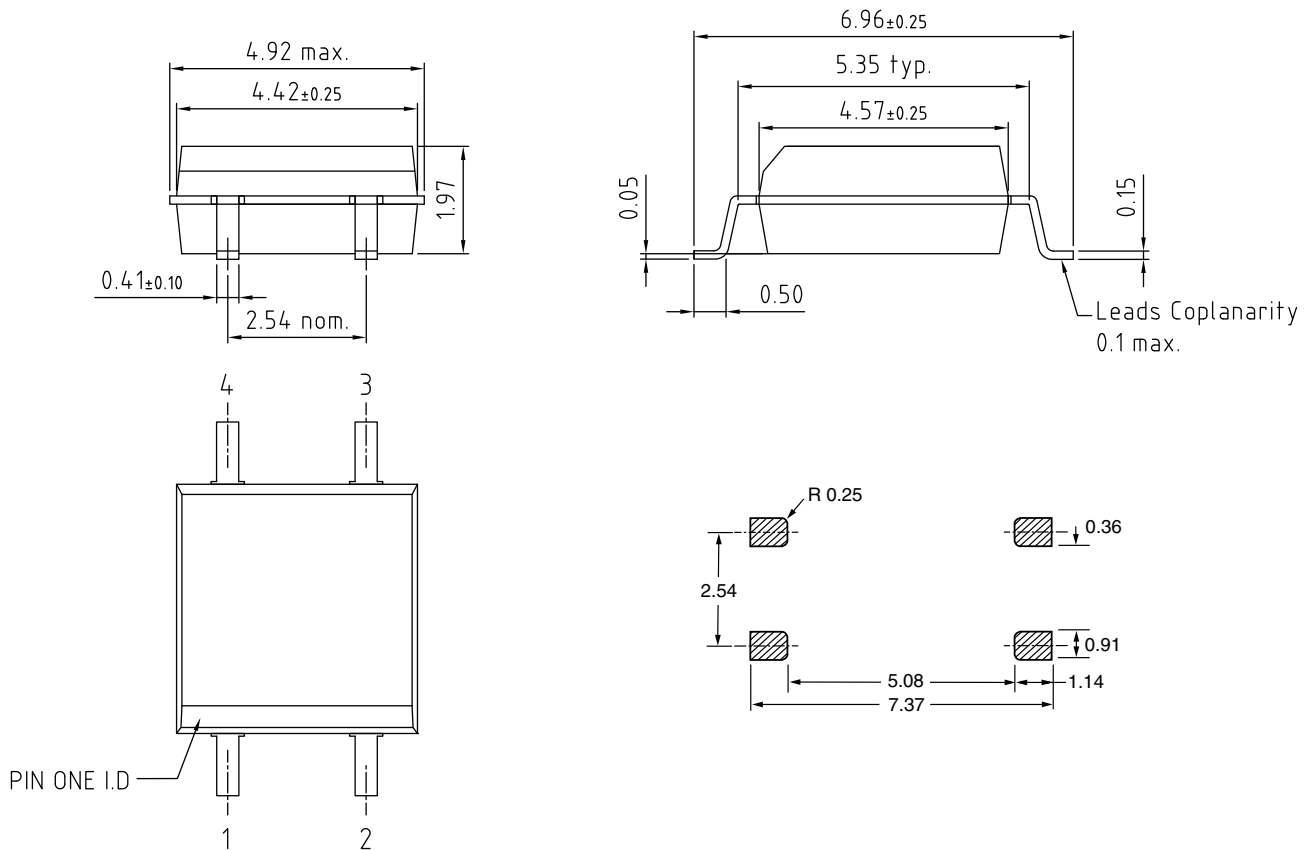

Fig. 11 - Trigger Current vs. Load Voltage



### PACKAGE DIMENSIONS in millimeters



### PACKAGE MARKING (example)

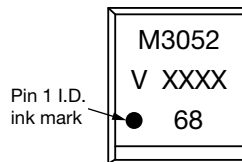

#### Note

- XXXX = LMC (lot marking code)

### TAPE AND REEL PACKAGING

Dimensions in millimeters

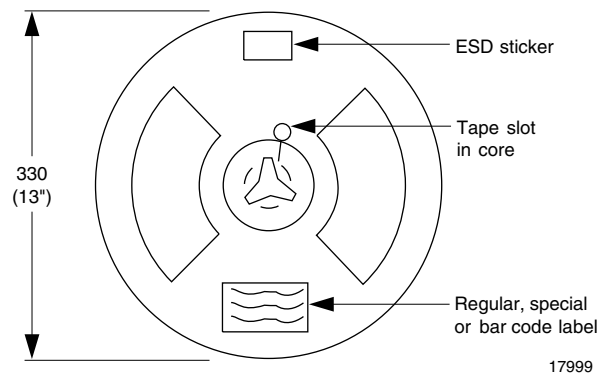

Fig. 12 - Tape and Reel Shipping Medium, 2000 Units per Reel

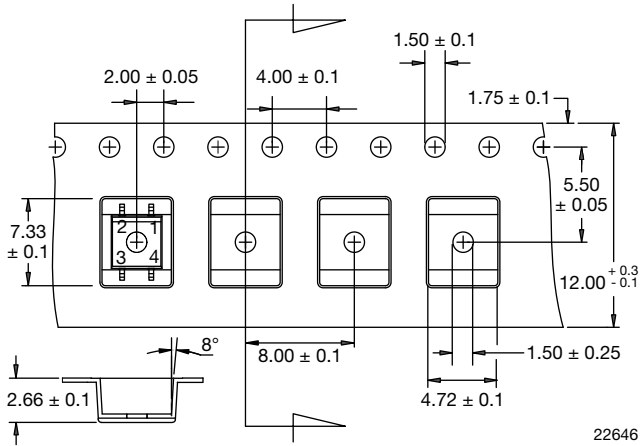

Fig. 13 - Tape Dimensions

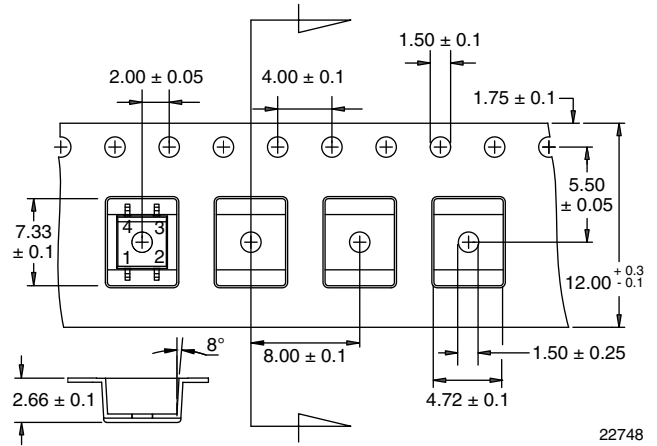

Fig. 14 - Tape Dimensions (order code T3)

**SOLDER PROFILE**

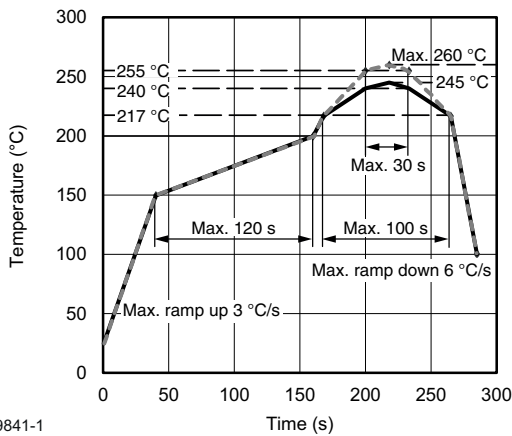

Fig. 15 - Lead (Pb)-Free Reflow Solder Profile According to J-STD-020

**HANDLING AND STORAGE CONDITIONS**

ESD level: HBM class 2

Floor life: unlimited

Conditions:  $T_{amb} < 30\text{ °C}$ , RH < 85 %

Moisture sensitivity level 1, according to J-STD-020



## Disclaimer

ALL PRODUCT, PRODUCT SPECIFICATIONS AND DATA ARE SUBJECT TO CHANGE WITHOUT NOTICE TO IMPROVE RELIABILITY, FUNCTION OR DESIGN OR OTHERWISE.

Vishay Intertechnology, Inc., its affiliates, agents, and employees, and all persons acting on its or their behalf (collectively, "Vishay"), disclaim any and all liability for any errors, inaccuracies or incompleteness contained in any datasheet or in any other disclosure relating to any product.

Vishay makes no warranty, representation or guarantee regarding the suitability of the products for any particular purpose or the continuing production of any product. To the maximum extent permitted by applicable law, Vishay disclaims (i) any and all liability arising out of the application or use of any product, (ii) any and all liability, including without limitation special, consequential or incidental damages, and (iii) any and all implied warranties, including warranties of fitness for particular purpose, non-infringement and merchantability.

Statements regarding the suitability of products for certain types of applications are based on Vishay's knowledge of typical requirements that are often placed on Vishay products in generic applications. Such statements are not binding statements about the suitability of products for a particular application. It is the customer's responsibility to validate that a particular product with the properties described in the product specification is suitable for use in a particular application. Parameters provided in datasheets and / or specifications may vary in different applications and performance may vary over time. All operating parameters, including typical parameters, must be validated for each customer application by the customer's technical experts. Product specifications do not expand or otherwise modify Vishay's terms and conditions of purchase, including but not limited to the warranty expressed therein.

Hyperlinks included in this datasheet may direct users to third-party websites. These links are provided as a convenience and for informational purposes only. Inclusion of these hyperlinks does not constitute an endorsement or an approval by Vishay of any of the products, services or opinions of the corporation, organization or individual associated with the third-party website. Vishay disclaims any and all liability and bears no responsibility for the accuracy, legality or content of the third-party website or for that of subsequent links.

Except as expressly indicated in writing, Vishay products are not designed for use in medical, life-saving, or life-sustaining applications or for any other application in which the failure of the Vishay product could result in personal injury or death. Customers using or selling Vishay products not expressly indicated for use in such applications do so at their own risk. Please contact authorized Vishay personnel to obtain written terms and conditions regarding products designed for such applications.

No license, express or implied, by estoppel or otherwise, to any intellectual property rights is granted by this document or by any conduct of Vishay. Product names and markings noted herein may be trademarks of their respective owners.