

THIS DOCUMENT IS THE PROPERTY OF
KEYSTONE ELECTRONICS CORP. AND
SHALL NOT BE REPRODUCED, DISTRIBUTED
OR USED AS A BASIS FOR MANUFACTURE
WITHOUT PRIOR WRITTEN PERMISSION
FROM KEYSTONE ELECTRONICS CORP.

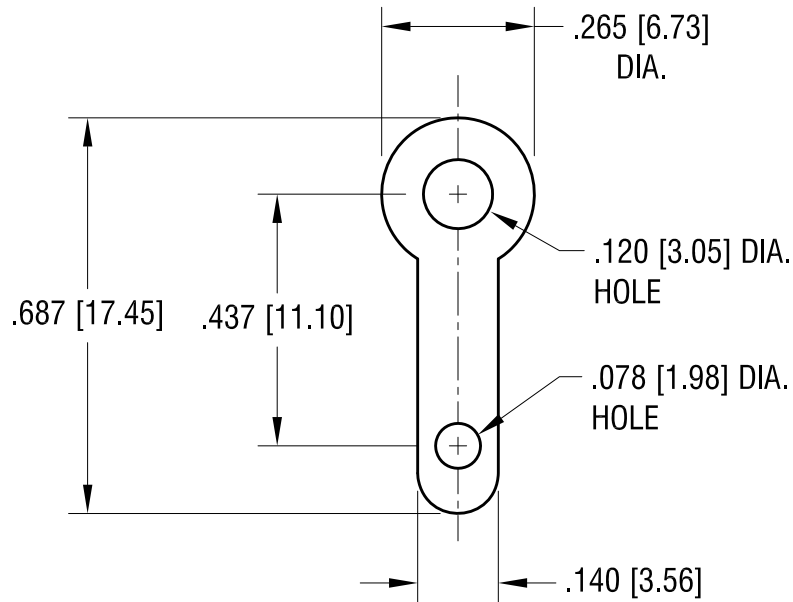
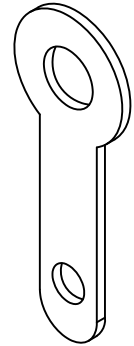

KEYSTONE ELECTRONICS CORP.

www.keyelco.com • ASTORIA, N.Y. 11105-2017 • Tel (718) 956-8900

PART NAME

SOLDER TERMINAL LUG

MATERIAL

.020 [0.50] TH'K BRASS

FINISH

MATTE TIN PLATE

DRN BY

BOONE

DATE

3.15.84

APP'D

LN

SCALE

3X

TOLERANCES

INCH [MM]

DECIMAL

$\pm .005$ [± 0.15]

ANGULAR

$\pm 1^\circ$

UNLESS OTHERWISE SPECIFIED

CODE

C

DWG NO.

7325

6.25.09 CHANGE AS PER ECN 09-082

B

1.9.08 CHANGE AS PER ECN 08-041

A

DATE

DESCRIPTION

REV.

Mouser Electronics

Authorized Distributor

Click to View Pricing, Inventory, Delivery & Lifecycle Information:

[Keystone Electronics:](#)

[7325](#)