



# 80x80x20 mm

San Ace 80 9GA type Low Power Consumption Fan

## General Specifications

- Material ..... Frame: Plastic (Flammability: UL 94V-0), Impeller: Plastic (Flammability: UL 94V-0)
- Expected life ..... See the table below. (L10 life: 90% survival rate for continuous operation in free air at 60°C, rated voltage)
- Motor protection function ..... Locked rotor burnout protection, Reverse polarity protection  
For details, please refer to p. 547.
- Dielectric strength ..... 50/60 Hz, 500 VAC, for 1 minute (between lead wire conductors and frame)
- Insulation resistance ..... 10 MΩ or more with a 500 VDC megger (between lead wire conductors and frame)
- Sound pressure level (SPL) ..... At 1 m away from the air inlet
- Storage temperature ..... -30 to +70°C (Non-condensing)
- Lead wire ..... ⊕Red ⊖Black (Sensor) Yellow (Control) Brown
- Mass ..... 80 g

## Specifications

The models listed below **have ribs and pulse sensors with PWM control function.**

Model no.	Rated voltage [V]	Operating voltage range [V]	PWM duty cycle* [%]	Rated current [A]	Rated input [W]	Rated speed [min <sup>-1</sup> ]	Max. airflow [m <sup>3</sup> /min] [CFM]	Max. static pressure [Pa] [inchH <sub>2</sub> O]	SPL [dB (A)]	Operating temperature [°C]	Expected life [h]
<b>9GA0812P6G001</b>	12	10.2 to 13.8	100	0.3	3.6	5850	1.72 60.78	110 0.44	45	-20 to +70	40000/60°C (70000/40°C)
<b>9GA0812P6M001</b>				0.06	0.72	2900	0.84 29.68	27 0.11	26.5		60000/60°C
<b>9GA0824P6G001</b>	24	20.4 to 27.6	100	0.15	3.6	5850	1.72 60.78	110 0.44	45		40000/60°C (70000/40°C)
<b>9GA0824P6M001</b>				0.03	0.72	2900	0.84 29.68	27 0.11	26.5		60000/60°C

\* PWM frequency: 25 kHz. Fan does not rotate when PWM duty cycle is 0%.

The following sensor and control options are available for selection.

Available for all models. Without sensor Pulse sensor

## Airflow - Static Pressure Characteristics / PWM Duty - Speed Characteristics Example

**9GA0812P6G001** With pulse sensor with PWM control function

PWM duty cycle

Operating voltage range

PWM duty - Speed characteristics example

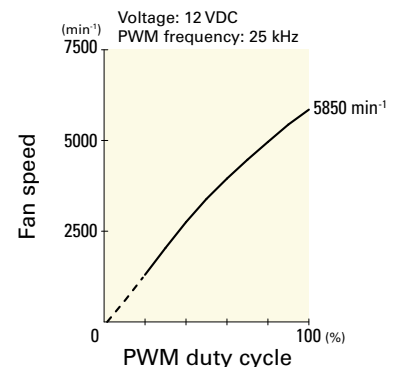
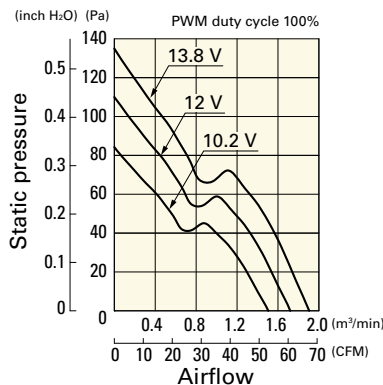
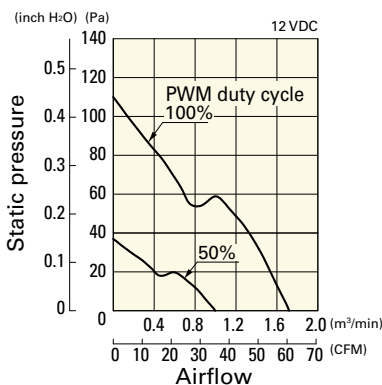

# Airflow - Static Pressure Characteristics / PWM Duty - Speed Characteristics Example

**9GA0812P6M001** With pulse sensor with PWM control function

PWM duty cycle

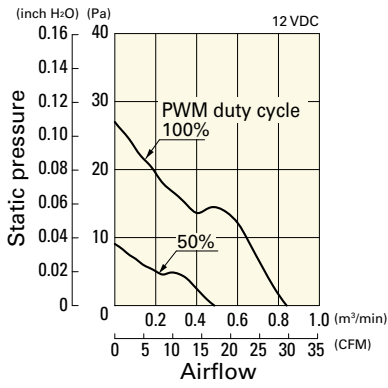

Operating voltage range

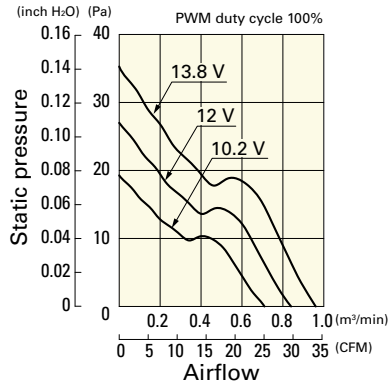

PWM duty - Speed characteristics example

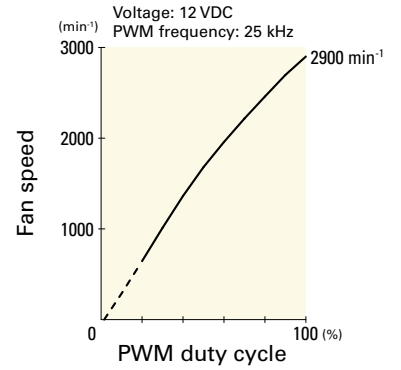

**9GA0824P6G001** With pulse sensor with PWM control function

PWM duty cycle

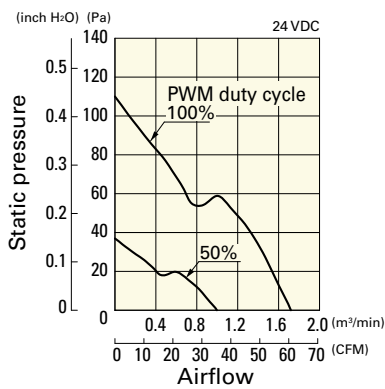

Operating voltage range

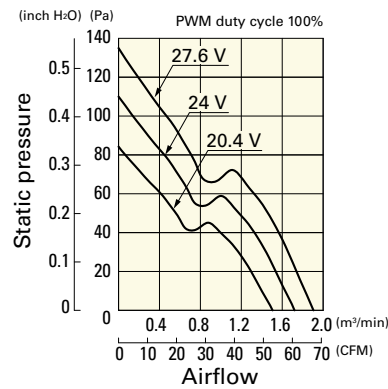

PWM duty - Speed characteristics example

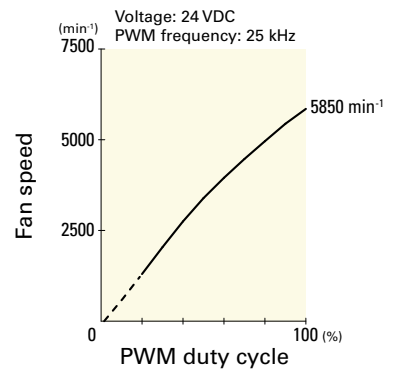

**9GA0824P6M001** With pulse sensor with PWM control function

PWM duty cycle

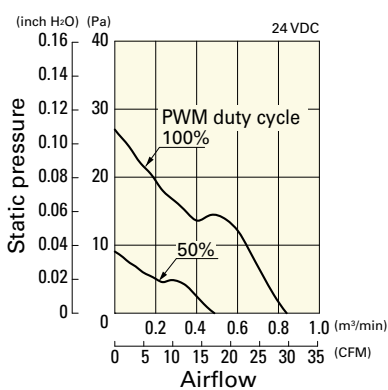

Operating voltage range

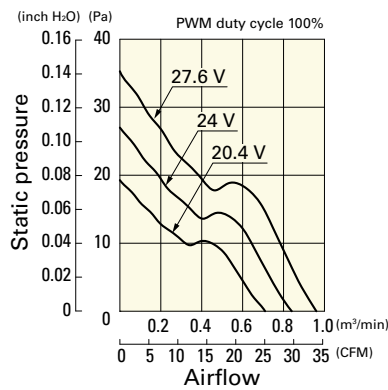

PWM duty - Speed characteristics example

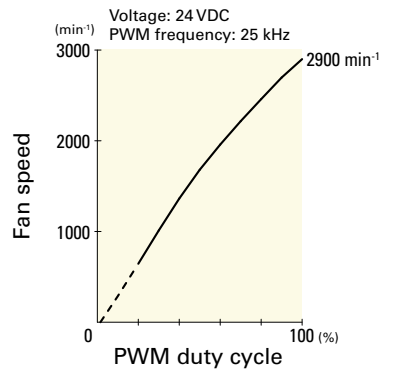

## ■ Dimensions (unit: mm)

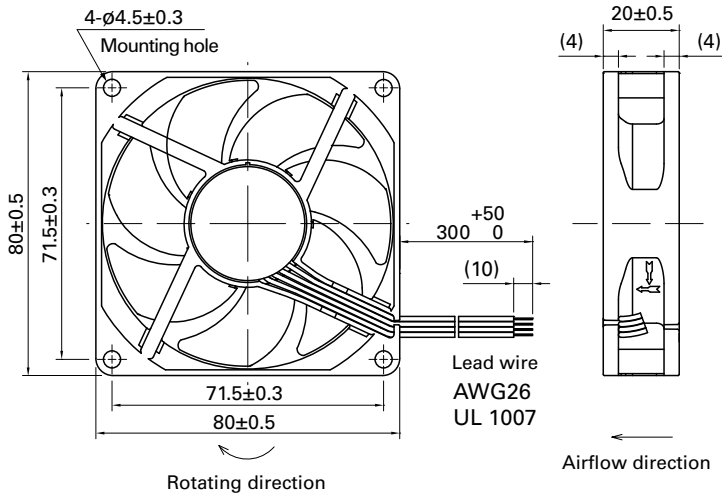

## ■ Reference Dimensions of Mounting Holes and Vent Opening (unit: mm)

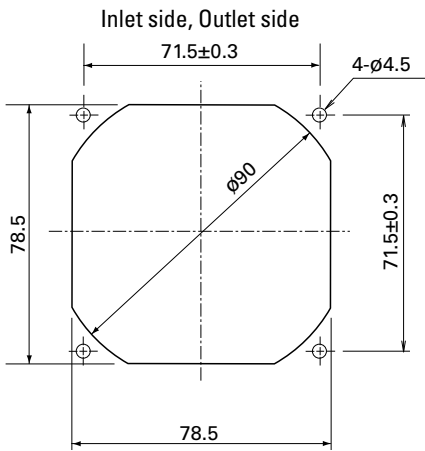

## ■ Options

### Finger guards

page: p. 532

Model no.: 109-049E, 109-049H, 109-049C

### Resin finger guards

page: p. 539

Model no.: 109-1002G

### Resin filter kits

page: p. 540

Model no.: 109-1002F13 (13PPI), 109-1002F20 (20PPI),  
109-1002F30 (30PPI), 109-1002F40 (40PPI)

# Mouser Electronics

Authorized Distributor

Click to View Pricing, Inventory, Delivery & Lifecycle Information:

## Sanyo Denki:

[9GA0812P6G001](#) [9GA0812P6M001](#) [9GA0824P6G001](#) [9GA0824P6M001](#) [9GA0824G6001](#) [9GA0824M6001](#)  
[9GA0824M6002](#) [9GA0812M6001](#) [9GA0812M6002](#) [9GA0824G6002](#)