

698-960 & 1710-2700 MHz LTE WORLD BAND ANTENNA

Part Numbers: 2361492-1, 2361492-2



FEATURES & BENEFITS

- Adhesive backing on the PCB simplifies mounting within the device
- Omnidirectional coverage
- Efficient design reduces power usage
- No matching components required
- Ground-plane independent design

SPECIFICATIONS

Frequency Range (MHz)	698-960	1710-2700
VSWR	< 4.0:1	< 3.0:1
Efficiency	80%	70%
Average Gain	-2.0dBi	-2.0dBi
Peak Gain	3.0dBi	4.0dBi
Power Handling	10 Watt cw	
Feed Point Impedance	50 ohms unbalanced	
Polarization	Linear	
Size	65 mm x 15 mm x 1.0 mm	
Weight	< 2.9 g	
Mounting	Adhesive Tape	
Mating Connector	MHF-type receptacle (TE PN 2337019-1)	
Operating Temperature	-40 to +85°C	
Cable	Coaxial Cable : 1.13mm Dia.	
Storage Temperature	-40 to +85°C	
Hazardous Materials	A certificate of conformance is available from the product page on TE website.	

RF DATA

VSWR

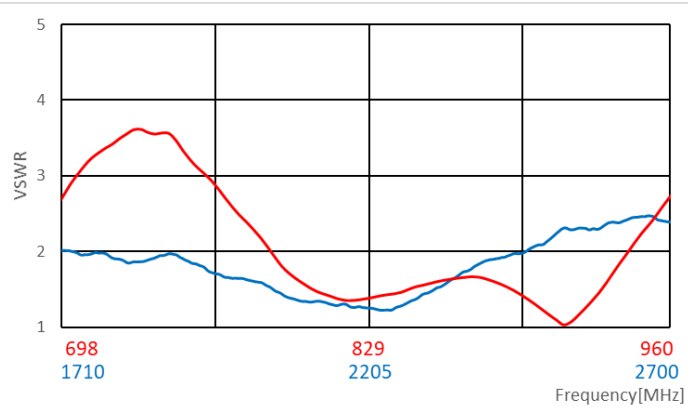

Return Loss

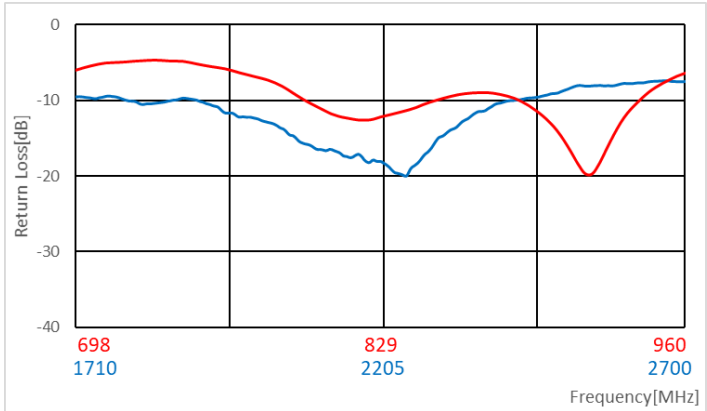

Efficiency

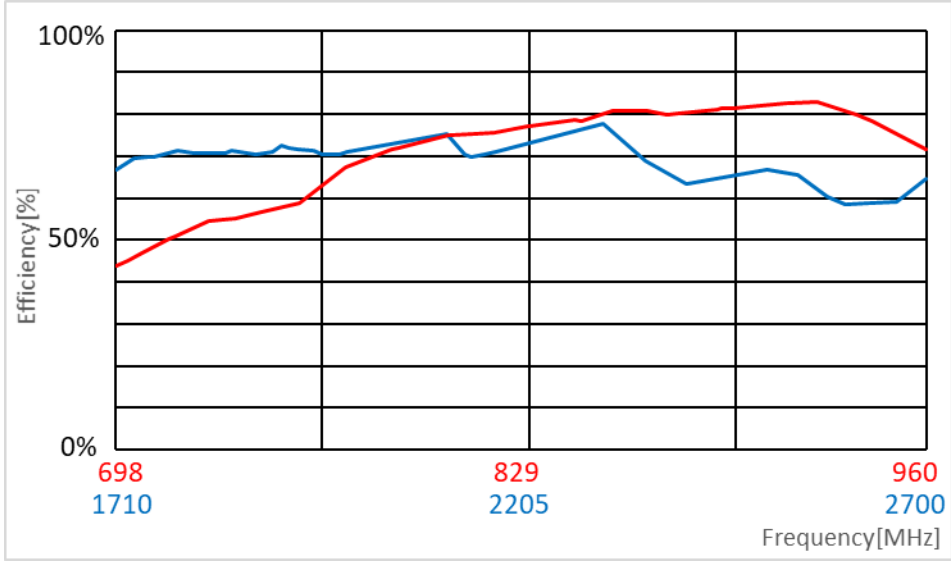

Data measured in free space and on plastic device enclosure

RADIATION PATTERN

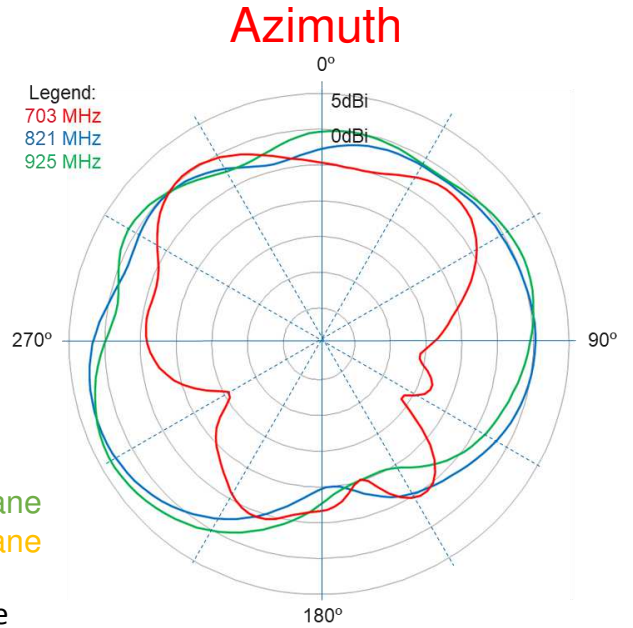
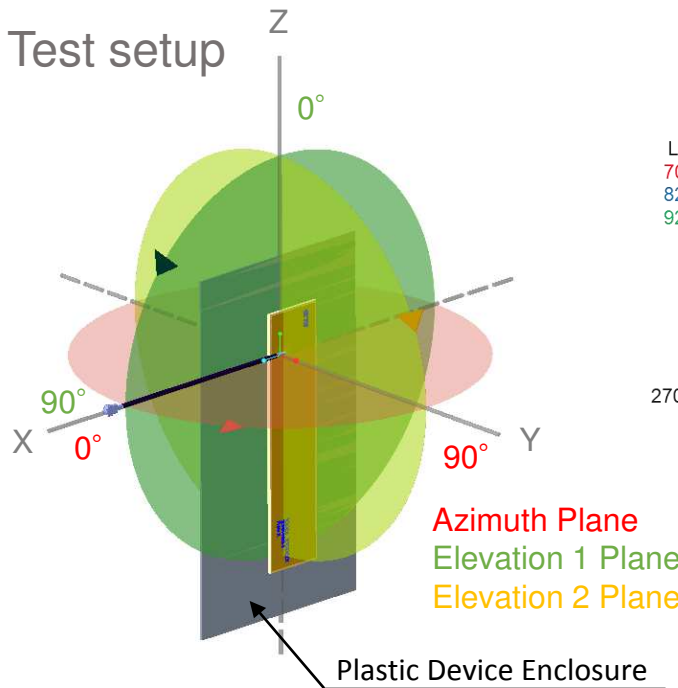

Elevation 1

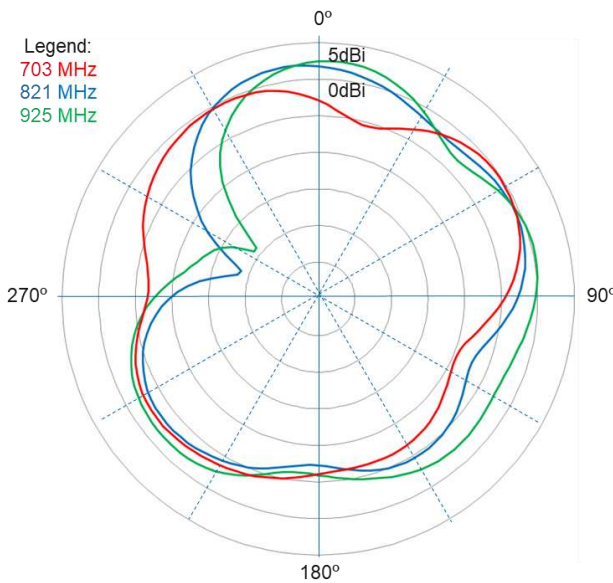

Elevation 2

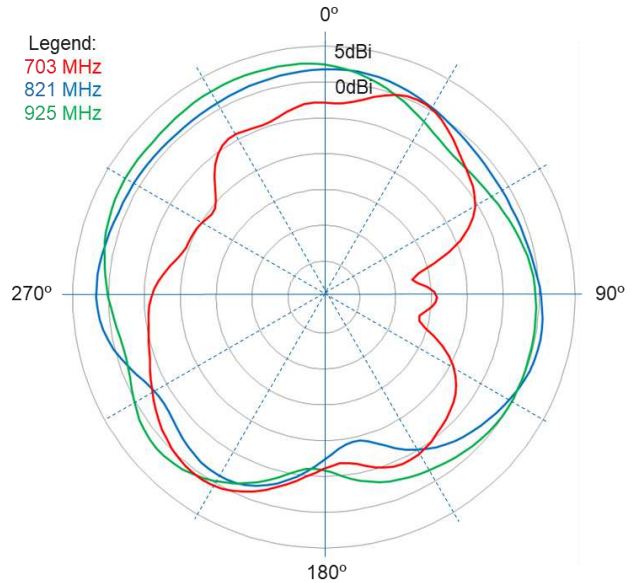

Data measured in free space and on plastic device enclosure

RADIATION PATTERN

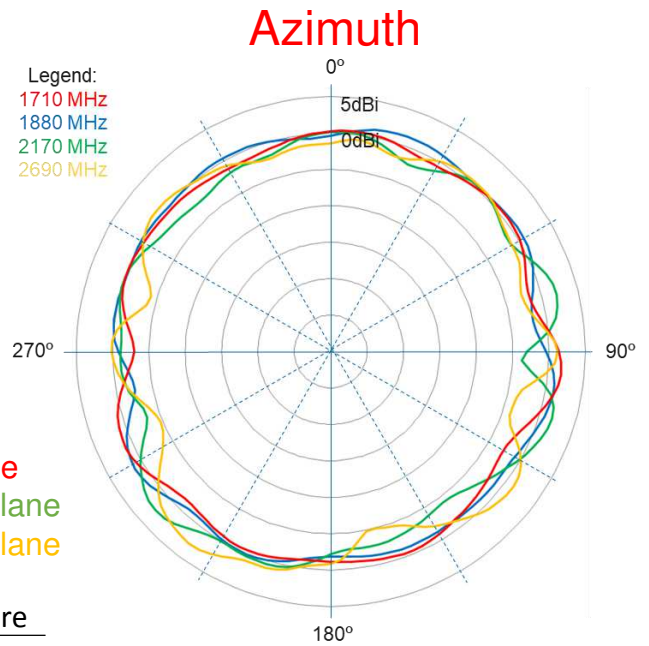
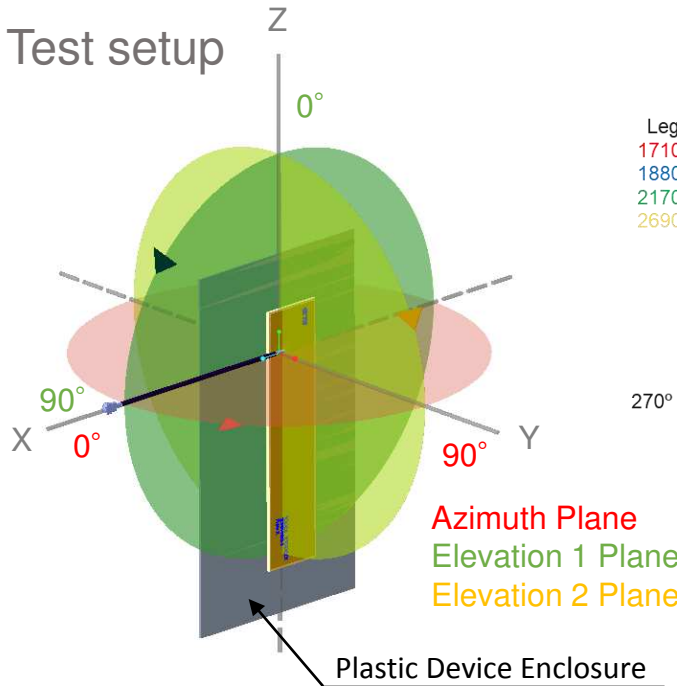

Elevation 1

Elevation 2

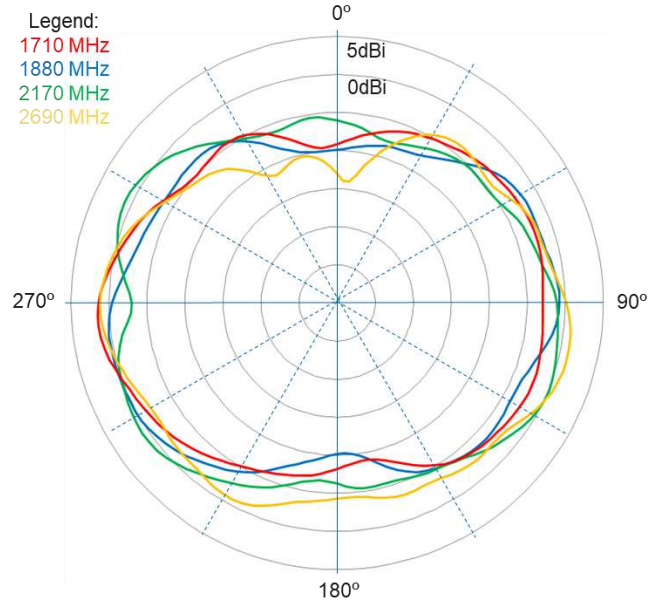
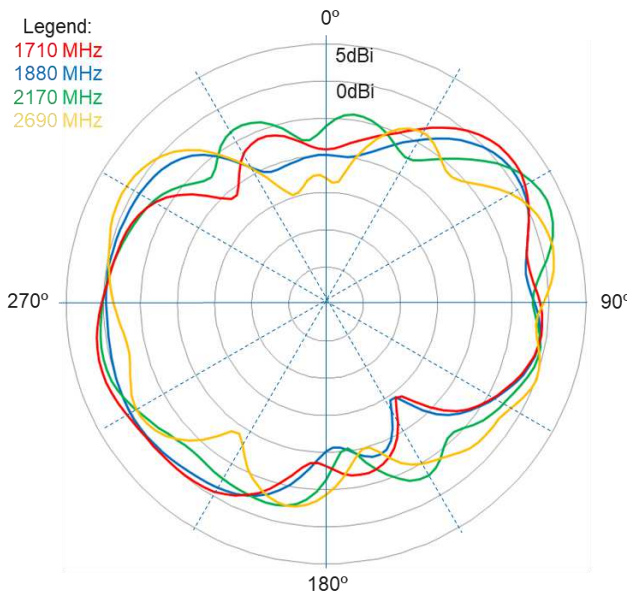

Data measured in free space and on plastic device enclosure

LTE WORLD BAND ANTENNA

Standard Antenna Solutions

KEEP OUT AREA

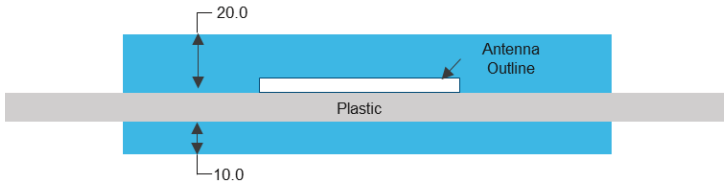

NOTES

1. Antenna designed to be mounted on plastic cover.
2. Area in blue indicates Keep Out Area.
3. For more information please call TE.

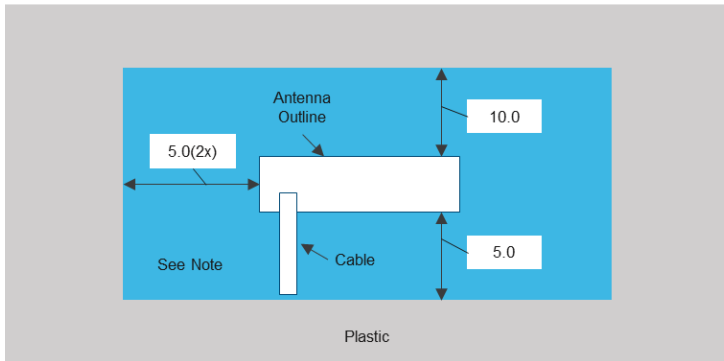

Dimension: mm

Diagram is not to scale

DIMENSIONS

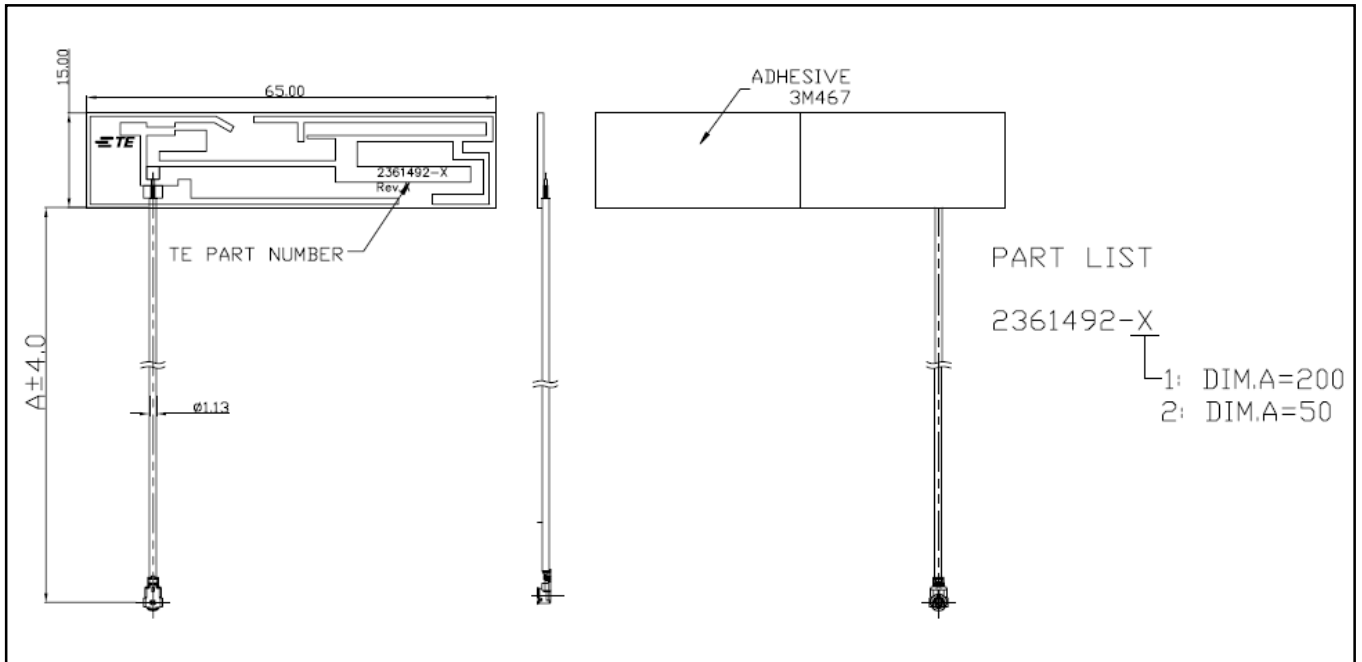

MATING COMPONENTS

2361492-1	200	7.87	MHF-TYPE PLUG	RECEPTACLE (TE PN: 2337019-1)	
2361492-2	50	1.97	MHF-TYPE PLUG	RECEPTACLE (TE PN: 2337019-1)	
PART NUMBER	MM	INCH	CONNECTOR TYPE (ON CABLE)	PART NUMBER	IMAGE
	CABLE LENGTH			MATING COMPONENTS	

PACKAGING

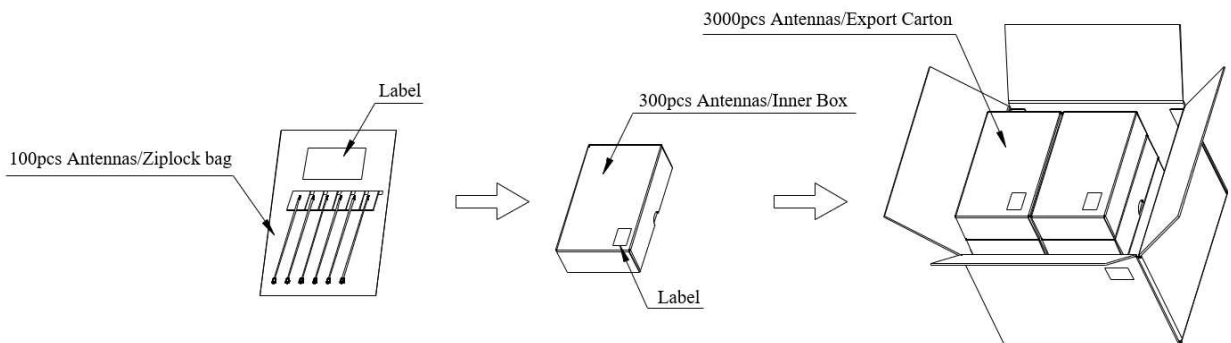

TE TECHNICAL SUPPORT CENTER

- USA: +1 (800) 522-6752
- Canada: +1 (905) 475-6222
- Mexico: +52 (0) 55-1106-0800
- Latin/S. America: +54 (0) 11-4733-2200
- Germany: +49 (0) 6251-133-1999
- UK: +44 (0) 800-267666
- France: +33 (0) 1-3420-8686
- Netherlands: +31 (0) 73-6246-999
- China: +86 (0) 400-820-6015

For phone numbers in other countries, go to te.com/support-center

te.com

TE Connectivity, TE Connectivity (logo) are trademarks. All other logos, products and/or company names referred to herein might be trademarks of their respective owners.

The information given herein, including drawings, illustrations and schematics which are intended for illustration purposes only, is believed to be reliable. However, TE Connectivity makes no warranties as to its accuracy or completeness and disclaims any liability in connection with its use. TE Connectivity's obligations shall only be as set forth in TE Connectivity's Standard Terms and Conditions of Sale for this product and in no case will TE Connectivity be liable for any incidental, indirect or consequential damages arising out of the sale, resale, use or misuse of the product. Users of TE Connectivity products should make their own evaluation to determine the suitability of each such product for the specific application.

© 2020 TE Connectivity Ltd. family of companies All Rights Reserved.

11/2020