

# GF1A - GF1M

---

## General Purpose Rectifiers (Glass Passivated)

### Features

- Low Forward Voltage Drop
- High Current Capability
- Easy Pick and Place
- High Surge Current Capability
- This Device is Pb-Free and is RoHS Compliant



**ON Semiconductor®**

[www.onsemi.com](http://www.onsemi.com)

---

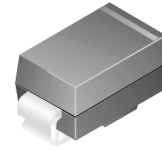

**SMA  
CASE 403AE**  
(COLOR BAND DENOTES CATHODE)

---

### MARKING DIAGRAM

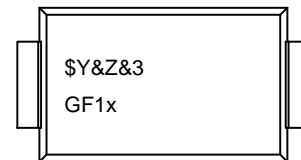

\$Y	= ON Semiconductor Logo
&Z	= Assembly Plant Code
&3	= Data Code (Year & Week)
GF1x	= Specific Device Code
x	= A/B/D/G/J/K/M

---

### ORDERING INFORMATION

See detailed ordering and shipping information on page 2 of this data sheet.

# GF1A – GF1M

## ABSOLUTE MAXIMUM RATINGS $T_A = 25^\circ\text{C}$ unless otherwise noted

Symbol	Parameter	Value							Units
		1A	1B	1D	1G	1J	1K	1M	
$V_{RRM}$	Maximum Repetitive Reverse Voltage	50	100	200	400	600	800	1000	V
$I_{F(AV)}$	Average Rectified Forward Current, @ $T_L = 125^\circ\text{C}$	1.0							A
$I_{FSM}$	Non-repetitive Peak Forward Surge Current 8.3 ms Single Half-Sine-Wave	30							A
$T_{stg}$	Storage Temperature Range	-65 to +175							$^\circ\text{C}$
$T_J$	Operating Junction Temperature Range	-65 to +175							$^\circ\text{C}$

Stresses exceeding those listed in the Maximum Ratings table may damage the device. If any of these limits are exceeded, device functionality should not be assumed, damage may occur and reliability may be affected.

## THERMAL CHARACTERISTICS

Symbol	Parameter	Value	Units
$P_D$	Power Dissipation	1.8	W
$R_{\theta JA}$	Thermal Resistance, Junction-to-Ambient*	80	$^\circ\text{C}/\text{W}$
$R_{\theta JL}$	Thermal Resistance, Junction-to-Lead*	26	$^\circ\text{C}/\text{W}$

\*Device mounted on PCB with 0.2 x 0.2" (5.0 x 5.0 mm) copper pad areas.

## ELECTRICAL CHARACTERISTICS $T_A = 25^\circ\text{C}$ unless otherwise noted

Symbol	Parameter	Device							Units
		1A	1B	1D	1G	1J	1K	1M	
$V_F$	Maximum Forward Voltage @ 1.0 A	1.0				1.2			V
$t_{rr}$	Maximum Reverse Recovery Time $I_F = 0.5\text{ A}$ , $I_R = 1.0\text{ A}$ , $I_{rr} = 0.25\text{ A}$	2.0							$\mu\text{s}$
$I_R$	Maximum Reverse Current @ Rated $V_R$ $T_A = 25^\circ\text{C}$ $T_A = 125^\circ\text{C}$	5.0				50			$\mu\text{A}$
$C_T$	Typical Capacitance $V_R = 4.0\text{ V}$ , $f = 1.0\text{ MHz}$	15							pF

Product parametric performance is indicated in the Electrical Characteristics for the listed test conditions, unless otherwise noted. Product performance may not be indicated by the Electrical Characteristics if operated under different conditions.

## PACKAGE MARKING AND ORDERING INFORMATION

Device	Device Marking	Package	Quantity†
GF1A	GF1A	SMA	7500 / Tape & Reel
GF1B	GF1B		
GF1D	GF1D		
GF1G	GF1G		
GF1J	GF1J		
GF1K	GF1K		
GF1M	GF1M		

†For information on tape and reel specifications, including part orientation and tape sizes, please refer to our Tape and Reel Packaging Specifications Brochure, BRD8011/D.

# GF1A – GF1M

## TYPICAL CHARACTERISTICS

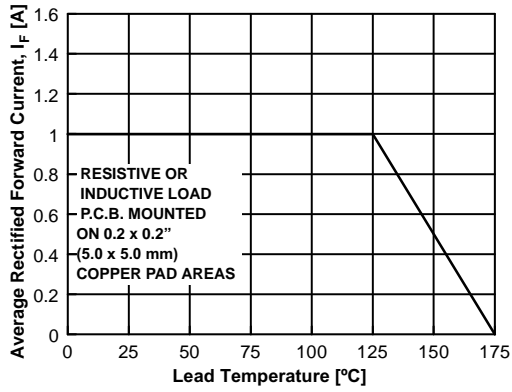

Figure 1. Forward Current Derating Curve

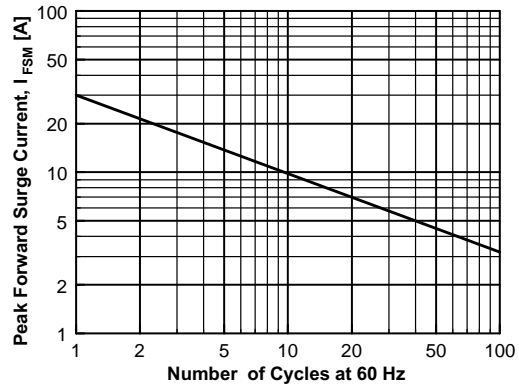

Figure 2. Non-Repetitive Surge Current

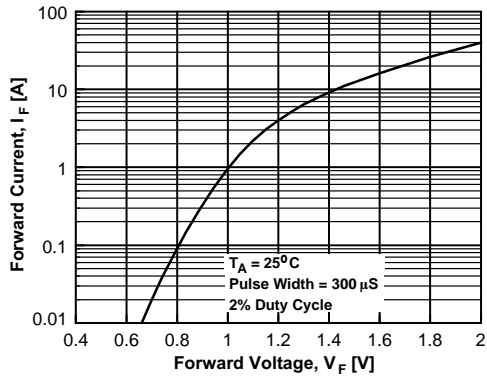

Figure 3. Forward Voltage Characteristics

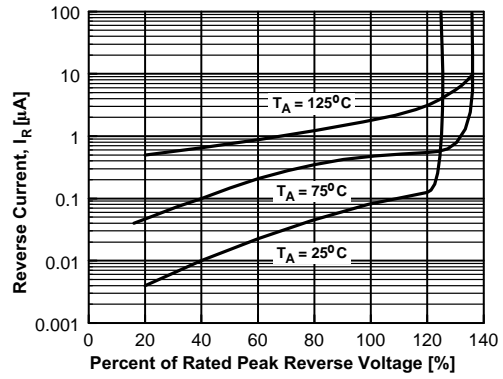

Figure 4. Reverse Current vs. Reverse Voltage

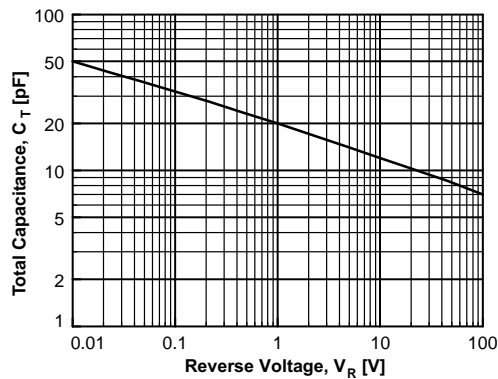

Figure 5. Total Capacitance

**MECHANICAL CASE OUTLINE**  
**PACKAGE DIMENSIONS**

ON Semiconductor®



**SMA**  
**CASE 403AE**  
**ISSUE O**

DATE 31 AUG 2016

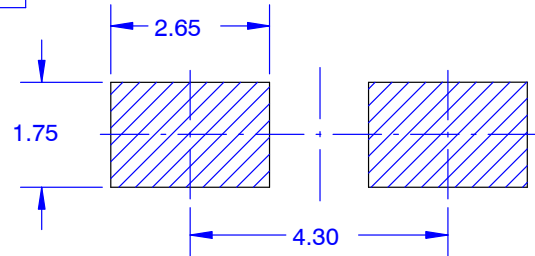
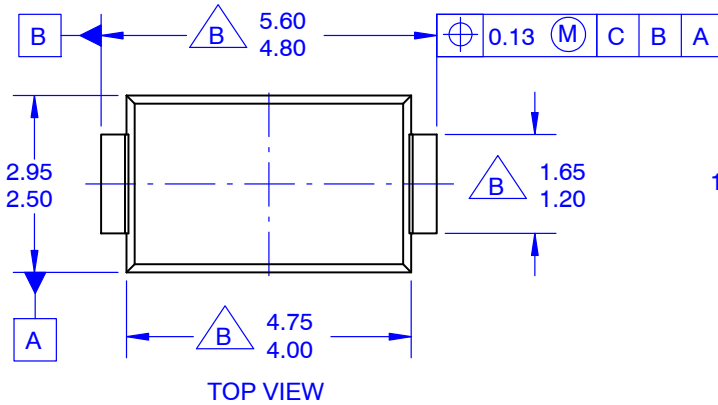

**NOTES:**

- A. EXCEPT WHERE NOTED, CONFORMS TO JEDEC DO214 VARIATION AC.
- B. DOES NOT COMPLY JEDEC STANDARD VALUE.
- C. ALL DIMENSIONS ARE IN MILLIMETERS.
- D. DIMENSIONS ARE EXCLUSIVE OF BURRS, MOLD FLASH AND TIE BAR PROTRUSIONS.
- E. DIMENSIONS AND TOLERANCE AS PER ASME Y14.5-2009.
- E. LAND PATTERN STD. DIOM5025X231M



<b>DOCUMENT NUMBER:</b>	<b>98AON13440G</b>	Electronic versions are uncontrolled except when accessed directly from the Document Repository. Printed versions are uncontrolled except when stamped "CONTROLLED COPY" in red.
<b>DESCRIPTION:</b>	<b>SMA</b>	<b>PAGE 1 OF 1</b>

ON Semiconductor and are trademarks of Semiconductor Components Industries, LLC dba ON Semiconductor or its subsidiaries in the United States and/or other countries. ON Semiconductor reserves the right to make changes without further notice to any products herein. ON Semiconductor makes no warranty, representation or guarantee regarding the suitability of its products for any particular purpose, nor does ON Semiconductor assume any liability arising out of the application or use of any product or circuit, and specifically disclaims any and all liability, including without limitation special, consequential or incidental damages. ON Semiconductor does not convey any license under its patent rights nor the rights of others.

**onsemi**, **Onsemi**, and other names, marks, and brands are registered and/or common law trademarks of Semiconductor Components Industries, LLC dba "**onsemi**" or its affiliates and/or subsidiaries in the United States and/or other countries. **onsemi** owns the rights to a number of patents, trademarks, copyrights, trade secrets, and other intellectual property. A listing of **onsemi**'s product/patent coverage may be accessed at [www.onsemi.com/site/pdf/Patent-Marking.pdf](http://www.onsemi.com/site/pdf/Patent-Marking.pdf). **onsemi** reserves the right to make changes at any time to any products or information herein, without notice. The information herein is provided "as-is" and **onsemi** makes no warranty, representation or guarantee regarding the accuracy of the information, product features, availability, functionality, or suitability of its products for any particular purpose, nor does **onsemi** assume any liability arising out of the application or use of any product or circuit, and specifically disclaims any and all liability, including without limitation special, consequential or incidental damages. Buyer is responsible for its products and applications using **onsemi** products, including compliance with all laws, regulations and safety requirements or standards, regardless of any support or applications information provided by **onsemi**. "Typical" parameters which may be provided in **onsemi** data sheets and/or specifications can and do vary in different applications and actual performance may vary over time. All operating parameters, including "Typicals" must be validated for each customer application by customer's technical experts. **onsemi** does not convey any license under any of its intellectual property rights nor the rights of others. **onsemi** products are not designed, intended, or authorized for use as a critical component in life support systems or any FDA Class 3 medical devices or medical devices with a same or similar classification in a foreign jurisdiction or any devices intended for implantation in the human body. Should Buyer purchase or use **onsemi** products for any such unintended or unauthorized application, Buyer shall indemnify and hold **onsemi** and its officers, employees, subsidiaries, affiliates, and distributors harmless against all claims, costs, damages, and expenses, and reasonable attorney fees arising out of, directly or indirectly, any claim of personal injury or death associated with such unintended or unauthorized use, even if such claim alleges that **onsemi** was negligent regarding the design or manufacture of the part. **onsemi** is an Equal Opportunity/Affirmative Action Employer. This literature is subject to all applicable copyright laws and is not for resale in any manner.

## PUBLICATION ORDERING INFORMATION

### LITERATURE FULFILLMENT:

Email Requests to: [orderlit@onsemi.com](mailto:orderlit@onsemi.com)

**onsemi Website:** [www.onsemi.com](http://www.onsemi.com)

### TECHNICAL SUPPORT

**North American Technical Support:**

Voice Mail: 1 800-282-9855 Toll Free USA/Canada

Phone: 011 421 33 790 2910

**Europe, Middle East and Africa Technical Support:**

Phone: 00421 33 790 2910

For additional information, please contact your local Sales Representative

# Mouser Electronics

Authorized Distributor

Click to View Pricing, Inventory, Delivery & Lifecycle Information:

[onsemi:](#)

[GF1A](#) [GF1B](#) [GF1D](#) [GF1G](#)