

ON Semiconductor

Is Now

onsemi™

To learn more about onsemi™, please visit our website at
www.onsemi.com

onsemi and **onsemi** and other names, marks, and brands are registered and/or common law trademarks of Semiconductor Components Industries, LLC dba "**onsemi**" or its affiliates and/or subsidiaries in the United States and/or other countries. **onsemi** owns the rights to a number of patents, trademarks, copyrights, trade secrets, and other intellectual property. A listing of **onsemi** product/patent coverage may be accessed at www.onsemi.com/site/pdf/Patent-Marking.pdf. **onsemi** reserves the right to make changes at any time to any products or information herein, without notice. The information herein is provided "as-is" and **onsemi** makes no warranty, representation or guarantee regarding the accuracy of the information, product features, availability, functionality, or suitability of its products for any particular purpose, nor does **onsemi** assume any liability arising out of the application or use of any product or circuit, and specifically disclaims any and all liability, including without limitation special, consequential or incidental damages. Buyer is responsible for its products and applications using **onsemi** products, including compliance with all laws, regulations and safety requirements or standards, regardless of any support or applications information provided by **onsemi**. "Typical" parameters which may be provided in **onsemi** data sheets and/or specifications can and do vary in different applications and actual performance may vary over time. All operating parameters, including "Typicals" must be validated for each customer application by customer's technical experts. **onsemi** does not convey any license under any of its intellectual property rights nor the rights of others. **onsemi** products are not designed, intended, or authorized for use as a critical component in life support systems or any FDA Class 3 medical devices or medical devices with a same or similar classification in a foreign jurisdiction or any devices intended for implantation in the human body. Should Buyer purchase or use **onsemi** products for any such unintended or unauthorized application, Buyer shall indemnify and hold **onsemi** and its officers, employees, subsidiaries, affiliates, and distributors harmless against all claims, costs, damages, and expenses, and reasonable attorney fees arising out of, directly or indirectly, any claim of personal injury or death associated with such unintended or unauthorized use, even if such claim alleges that **onsemi** was negligent regarding the design or manufacture of the part. **onsemi** is an Equal Opportunity/Affirmative Action Employer. This literature is subject to all applicable copyright laws and is not for resale in any manner. Other names and brands may be claimed as the property of others.



ON Semiconductor®

FGD2736G3-F085

EcoSPARK™ 3 270mJ, 360V, N-Channel Ignition IGBT

Features

- SCIS Energy = 270mJ at $T_J = 25^\circ\text{C}$
- SCIS Energy = 170mJ at $T_J = 150^\circ\text{C}$
- Logic Level Gate Drive
- RoHS Compliant



Applications

- Automotive Ignition Coil Driver Circuits
- Coil On Plug Applications

Package

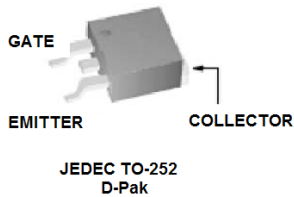

Symbol

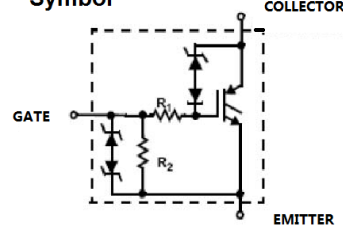

Absolute Maximum Ratings $T_A = 25^\circ\text{C}$ unless otherwise noted

Symbol	Parameter	Conditions	Ratings	Units
BV_{CER}	Collector to Emitter Breakdown Voltage ($I_C = 1\text{mA}$)		360	V
BV_{ECS}	Emitter to Collector Voltage - Reverse Battery Condition ($I_C = 10\text{mA}$)		28	V
$ESCIS_{25}$	$I_{SCIS} = 13.4\text{A}$, $L = 3.0\text{mH}$, $R_{GE} = 1\text{K}\Omega$	$T_C = 25^\circ\text{C}$	270	mJ
$ESCIS_{150}$	$I_{SCIS} = 10.8\text{A}$, $L = 3.0\text{mH}$, $R_{GE} = 1\text{K}\Omega$	$T_C = 150^\circ\text{C}$	170	mJ
I_{C25}	Collector Current Continuous, at $T_C = 25^\circ\text{C}$, $V_{GE} = 5.0\text{V}$		21	A
I_{C110}	Collector Current Continuous, at $T_C = 110^\circ\text{C}$, $V_{GE} = 5.0\text{V}$		18	A
V_{GEM}	Gate to Emitter Voltage Continuous		± 10	V
P_D	Power Dissipation Total	$T_C = 25^\circ\text{C}$	150	W
	Power Dissipation Derating	$T_C > 25^\circ\text{C}$	1	W/ $^\circ\text{C}$
T_J	Operating Junction Temperature Range		-40 to +175	$^\circ\text{C}$
T_{STG}	Storage Junction Temperature Range		-40 to +175	$^\circ\text{C}$
T_L	Max. Lead Temp. for Soldering (Leads at 1.6mm from case for 10s)		300	$^\circ\text{C}$
T_{PKG}	Max Lead Temp for soldering (Package Body for 10s)		260	$^\circ\text{C}$
ESD	Electrostatic Discharge Voltage at 100pF, 1500Ω		4	kV

FGD2736G3-F085 EcoSPARK™ 270mJ, 360V, N-Channel Ignition IGBT

Thermal Characteristics

$R_{\theta JC}$	Thermal Resistance Junction to Case	1	°C/W
-----------------	-------------------------------------	---	------

Electrical Characteristics of the IGBT $T_A = 25^\circ\text{C}$ unless otherwise noted

Symbol	Parameter	Test Conditions	Min	Typ	Max	Units
--------	-----------	-----------------	-----	-----	-----	-------

Off Characteristics

BV_{CER}	Collector to Emitter Breakdown Voltage	$V_{GE} = 0V, I_{CE} = 2mA,$ $R_{GE} = 1K\Omega,$ $T_J = -40 \text{ to } 150^\circ\text{C}$	330	-	390	V	
BV_{CES}	Collector to Emitter Breakdown Voltage	$V_{GE} = 0V, I_{CE} = 10mA,$ $R_{GE} = 0\Omega,$ $T_J = -40 \text{ to } 150^\circ\text{C}$	350	-	410	V	
BV_{ECS}	Emitter to Collector Breakdown Voltage	$V_{GE} = 0V, I_{CE} = -75mA,$ $T_J = 25^\circ\text{C}$	28	-	-	V	
BV_{GES}	Gate to Emitter Breakdown Voltage	$I_{GES} = \pm 5mA$	± 11	± 14	-	V	
I_{CER}	Collector to Emitter Leakage Current	$V_{CE} = 250V, R_{GE} = 1K\Omega$	$T_J = 25^\circ\text{C}$	-	-	25	μA
			$T_J = 150^\circ\text{C}$	-	-	1	mA
I_{ECS}	Emitter to Collector Leakage Current	$V_{EC} = 24V$	$T_J = 25^\circ\text{C}$	-	-	1	mA
			$T_J = 150^\circ\text{C}$	-	-	40	
R_1	Series Gate Resistance		-	110	-	Ω	
R_2	Gate to Emitter Resistance		10K	-	30K	Ω	

On Characteristics

$V_{CE(SAT)}$	Collector to Emitter Saturation Voltage	$V_{GE} = 4V, I_{CE} = 6A$	$T_J = 25^\circ\text{C}$	-	1.25	1.35	V
$V_{CE(SAT)}$	Collector to Emitter Saturation Voltage	$V_{GE} = 4.5V, I_{CE} = 10A$	$T_J = 25^\circ\text{C}$	-	1.45	1.65	V
$V_{CE(SAT)}$	Collector to Emitter Saturation Voltage		$T_J = 150^\circ\text{C}$		1.6	1.8	V

Dynamic Characteristics

$Q_{G(ON)}$	Gate Charge	$V_{GE} = 5V, V_{CE} = 12V, I_{CE} = 10A$	-	18	-	nC	
$V_{GE(TH)}$	Gate to Emitter Threshold Voltage	$I_{CE} = 1mA, V_{CE} = V_{GE},$	$T_J = 25^\circ\text{C}$	1.3	1.6	2.2	V
			$T_J = 150^\circ\text{C}$	0.75	1.1	1.8	
V_{GEP}	Gate to Emitter Plateau Voltage	$V_{CE} = 12V, I_{CE} = 10A$	-	3.0	-	V	

Switching Characteristics

$t_{d(ON)R}$	Current Turn-On Delay Time-Resistive	$V_{CE} = 14V, R_L = 1\Omega$	-	0.9	4	μs
t_{rR}	Current Rise Time-Resistive	$V_{GE} = 5V, R_G = 1K\Omega$	-	3	7	μs
$t_{d(OFF)L}$	Current Turn-Off Delay Time-Inductive	$V_{CE} = 300V, L = 2mH,$	-	4.4	15	μs
t_{fL}	Current Fall Time-Inductive	$V_{GE} = 5V, R_G = 1K\Omega$	-	1.9	15	μs

Ordering Information

Device Marking	Device	Package	Reel Size	Tape Width	Quantity
FGD2736G3	FGD2736G3-F085	TO-252AA	330mm	16mm	2500units

Typical Performance Curves

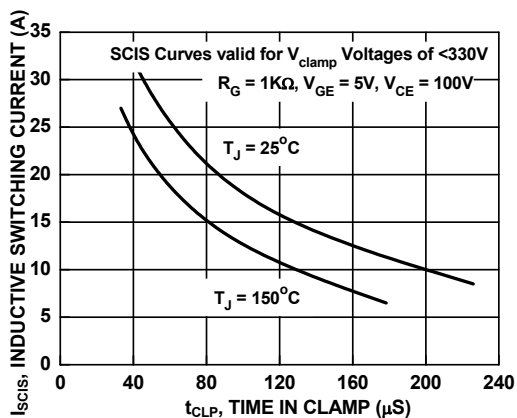

Figure 1. Self Clamped Inductive Switching Current vs. Time in Clamp

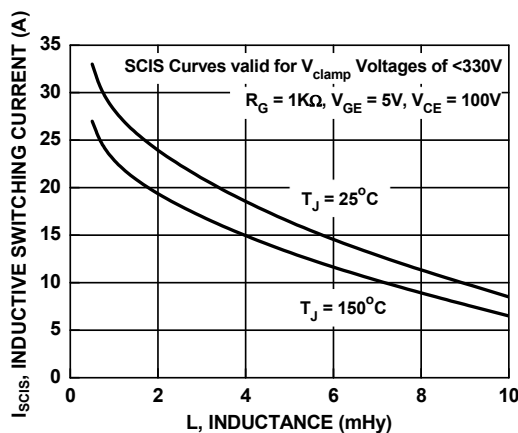

Figure 2. Self Clamped Inductive Switching Current vs. Inductance

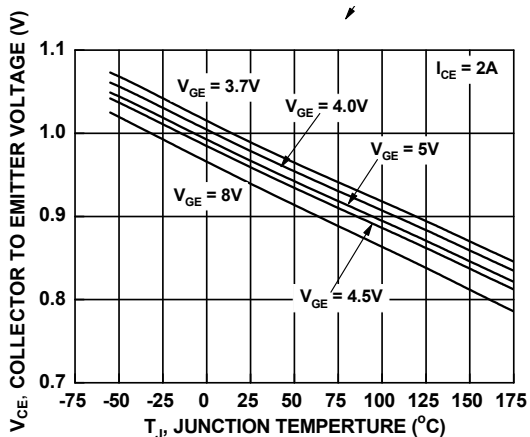

Figure 3. Collector to Emitter On-State Voltage vs. Junction Temperature

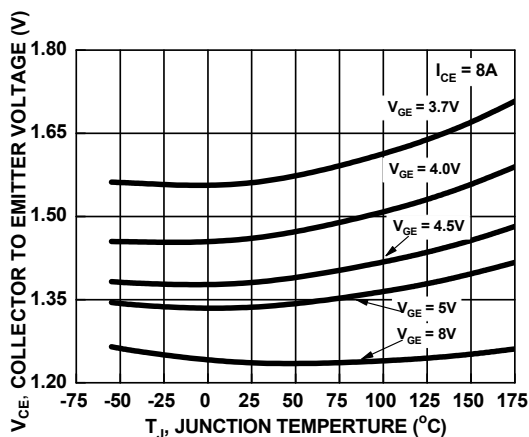

Figure 4. Collector to Emitter On-State Voltage vs. Junction Temperature

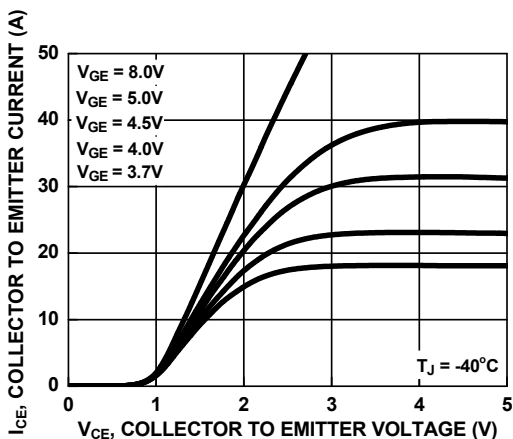

Figure 5. Collector to Emitter On-State Voltage vs. Collector Current

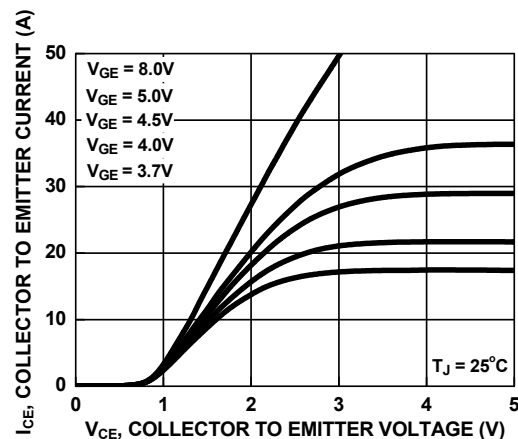

Figure 6. Collector to Emitter On-State Voltage vs. Collector Current

Typical Performance Curves (Continued)

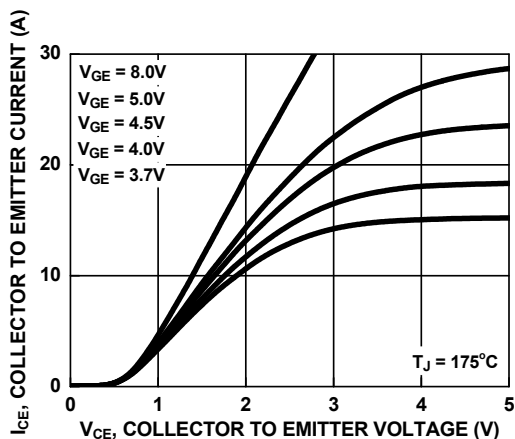

Figure 7. Collector to Emitter On-State Voltage vs. Collector Current

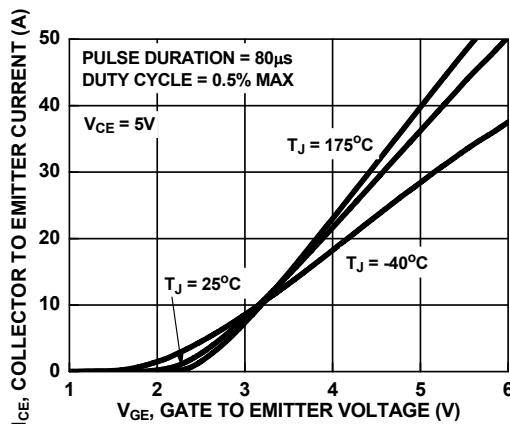

Figure 8. Transfer Characteristics

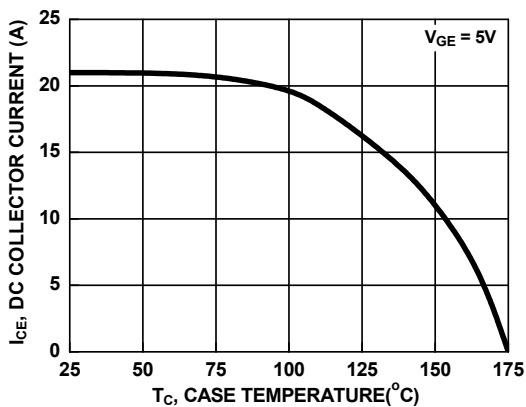

Figure 9. DC Collector Current vs. Case Temperature

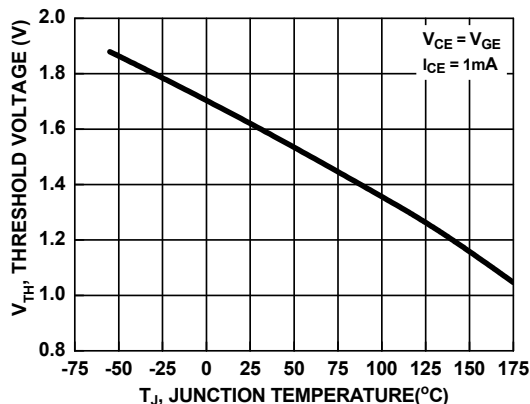

Figure 10. Threshold Voltage vs. Junction Temperature

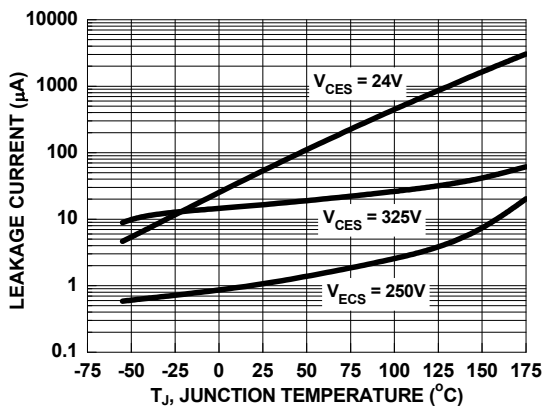

Figure 11. Leakage Current vs. Junction Temperature

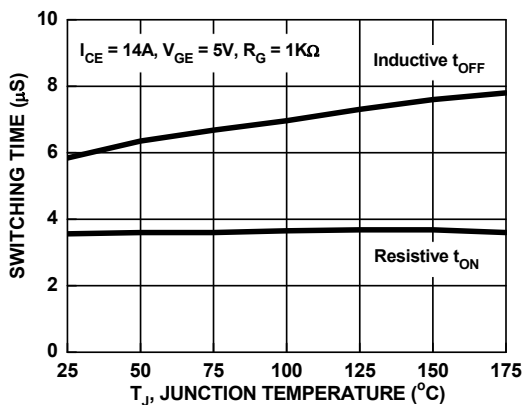

Figure 12. Switching Time vs. Junction Temperature

Typical Performance Curves (Continued)

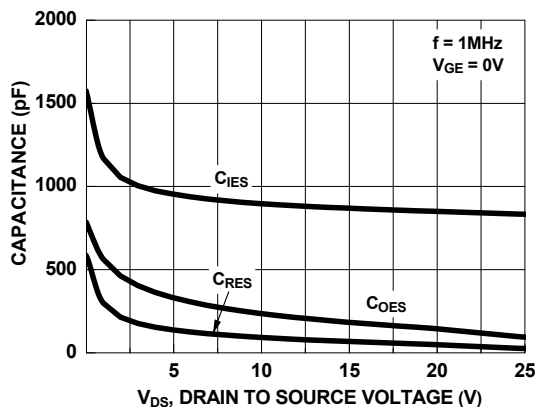

Figure 13. Capacitance vs. Collector to Emitter Voltage

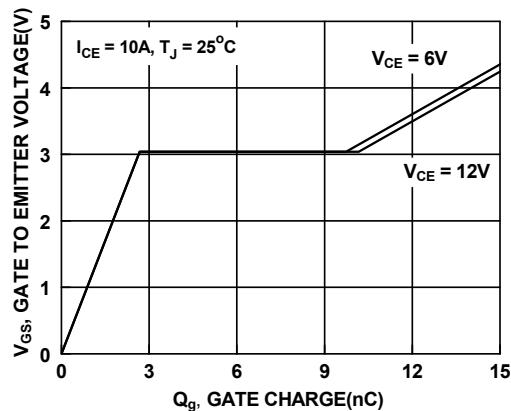

Figure 14. Gate Charge

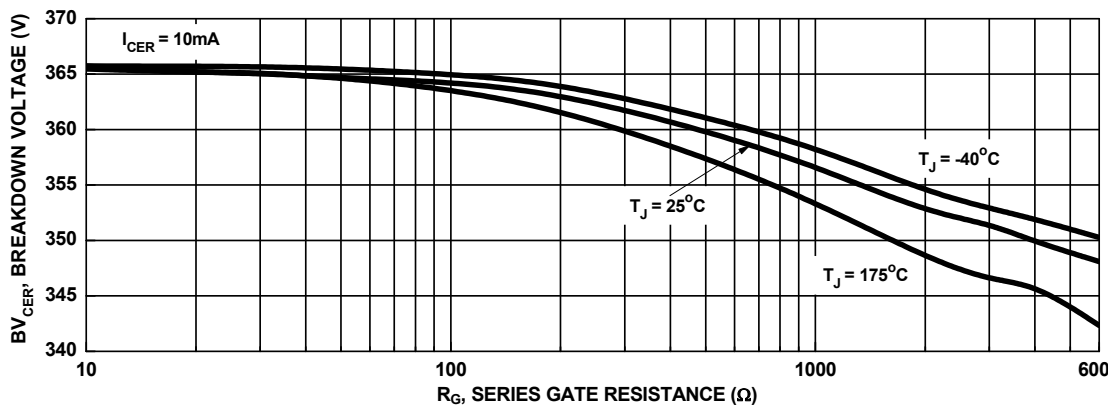

Figure 15. Break down Voltage vs. Series Gate Resistance

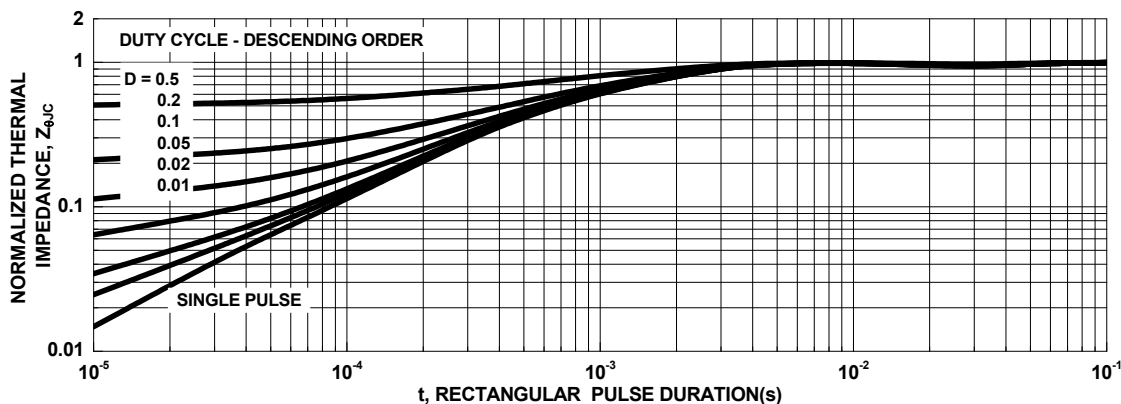

Figure 16. IGBT Normalized Transient Thermal Impedance, Junction to Case

Typical Performance Curves

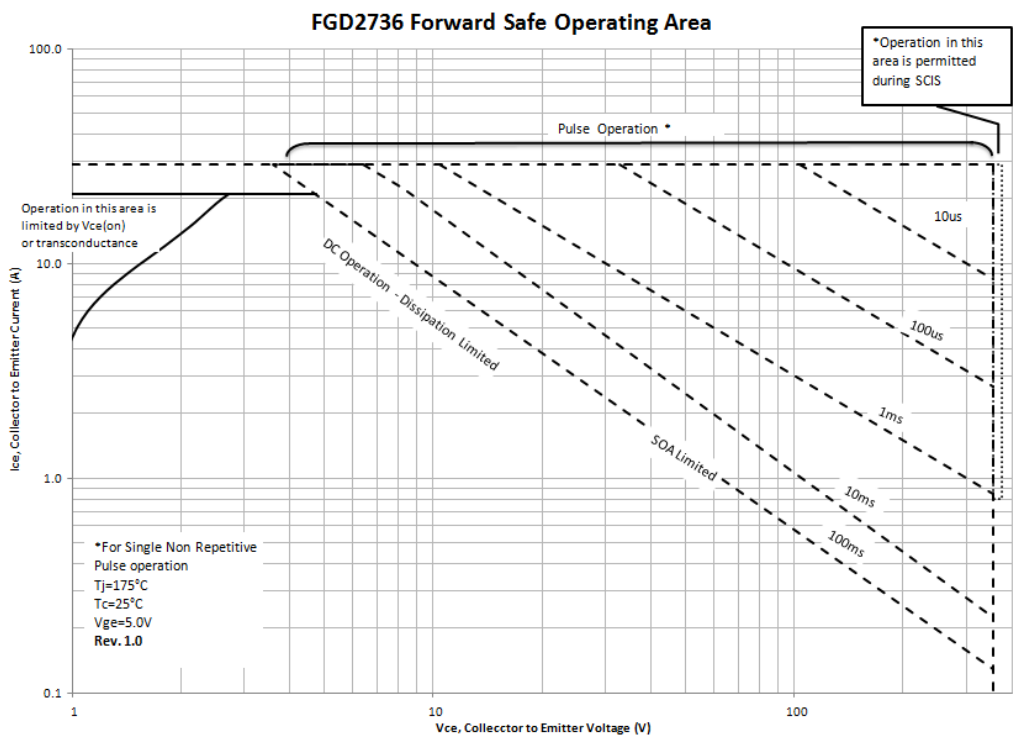
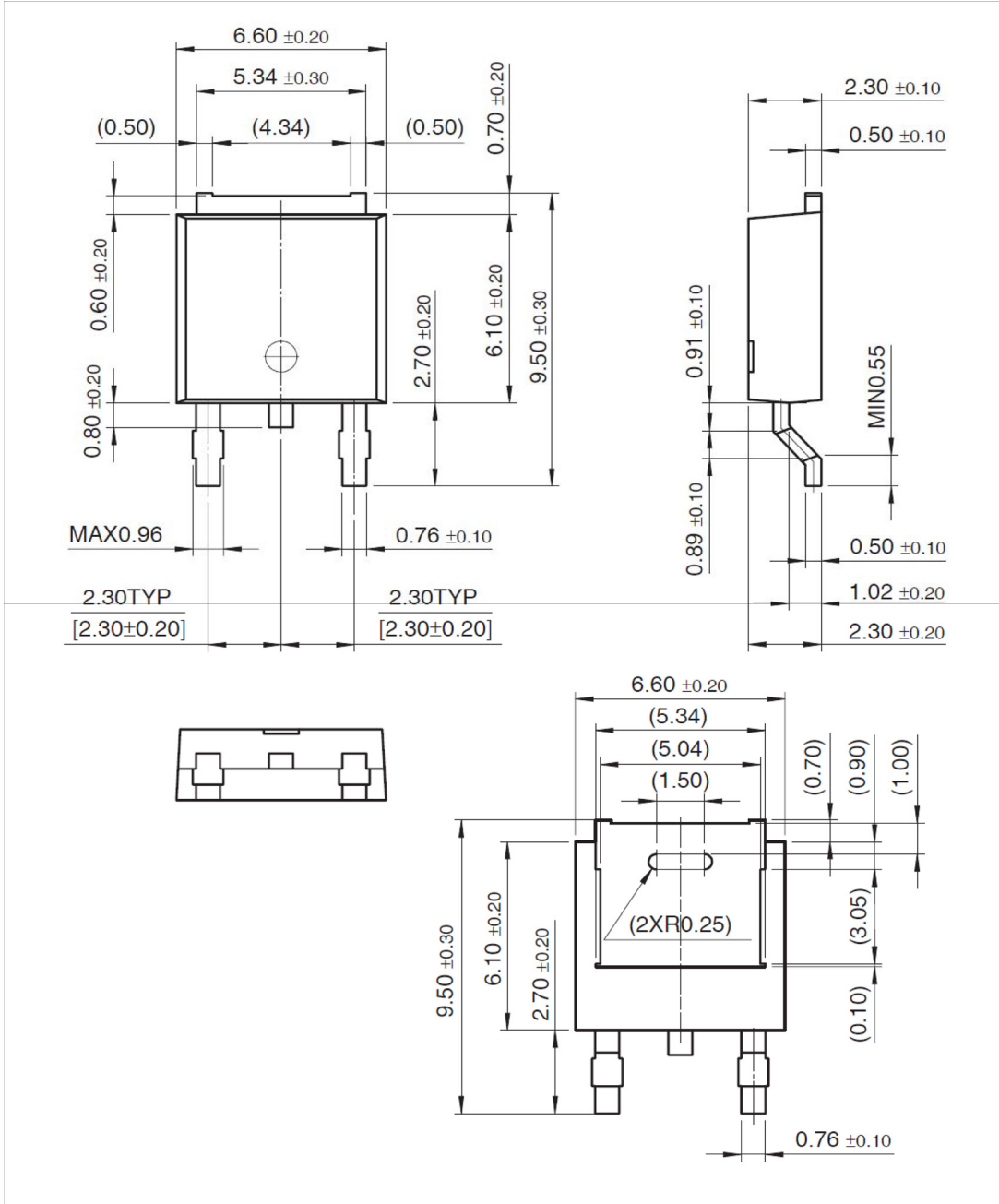

Figure 17. Forward Safe Operating Area

Physical Dimensions



ON Semiconductor and  are trademarks of Semiconductor Components Industries, LLC dba ON Semiconductor or its subsidiaries in the United States and/or other countries. ON Semiconductor owns the rights to a number of patents, trademarks, copyrights, trade secrets, and other intellectual property. A listing of ON Semiconductor's product/patent coverage may be accessed at www.onsemi.com/site/pdf/Patent-Marking.pdf. ON Semiconductor reserves the right to make changes without further notice to any products herein. ON Semiconductor makes no warranty, representation or guarantee regarding the suitability of its products for any particular purpose, nor does ON Semiconductor assume any liability arising out of the application or use of any product or circuit, and specifically disclaims any and all liability, including without limitation special, consequential or incidental damages. Buyer is responsible for its products and applications using ON Semiconductor products, including compliance with all laws, regulations and safety requirements or standards, regardless of any support or applications information provided by ON Semiconductor. "Typical" parameters which may be provided in ON Semiconductor data sheets and/or specifications can and do vary in different applications and actual performance may vary over time. All operating parameters, including "Typicals" must be validated for each customer application by customer's technical experts. ON Semiconductor does not convey any license under its patent rights nor the rights of others. ON Semiconductor products are not designed, intended, or authorized for use as a critical component in life support systems or any FDA Class 3 medical devices or medical devices with a same or similar classification in a foreign jurisdiction or any devices intended for implantation in the human body. Should Buyer purchase or use ON Semiconductor products for any such unintended or unauthorized application, Buyer shall indemnify and hold ON Semiconductor and its officers, employees, subsidiaries, affiliates, and distributors harmless against all claims, costs, damages, and expenses, and reasonable attorney fees arising out of, directly or indirectly, any claim of personal injury or death associated with such unintended or unauthorized use, even if such claim alleges that ON Semiconductor was negligent regarding the design or manufacture of the part. ON Semiconductor is an Equal Opportunity/Affirmative Action Employer. This literature is subject to all applicable copyright laws and is not for resale in any manner.

PUBLICATION ORDERING INFORMATION

LITERATURE FULFILLMENT:

Literature Distribution Center for ON Semiconductor
19521 E. 32nd Pkwy, Aurora, Colorado 80011 USA
Phone: 303-675-2175 or 800-344-3860 Toll Free USA/Canada
Fax: 303-675-2176 or 800-344-3867 Toll Free USA/Canada
Email: orderlit@onsemi.com

N. American Technical Support: 800-282-9855 Toll Free
USA/Canada
Europe, Middle East and Africa Technical Support:
Phone: 421 33 790 2910
Japan Customer Focus Center
Phone: 81-3-5817-1050

ON Semiconductor Website: www.onsemi.com
Order Literature: <http://www.onsemi.com/orderlit>
For additional information, please contact your local
Sales Representative

Mouser Electronics

Authorized Distributor

Click to View Pricing, Inventory, Delivery & Lifecycle Information:

[onsemi:](#)

[FGD2736G3-F085](#)