



Is Now Part of



ON Semiconductor®

To learn more about ON Semiconductor, please visit our website at
www.onsemi.com

Please note: As part of the Fairchild Semiconductor integration, some of the Fairchild orderable part numbers will need to change in order to meet ON Semiconductor's system requirements. Since the ON Semiconductor product management systems do not have the ability to manage part nomenclature that utilizes an underscore (_), the underscore (_) in the Fairchild part numbers will be changed to a dash (-). This document may contain device numbers with an underscore (_). Please check the ON Semiconductor website to verify the updated device numbers. The most current and up-to-date ordering information can be found at www.onsemi.com. Please email any questions regarding the system integration to Fairchild_questions@onsemi.com.

ON Semiconductor and the ON Semiconductor logo are trademarks of Semiconductor Components Industries, LLC dba ON Semiconductor or its subsidiaries in the United States and/or other countries. ON Semiconductor owns the rights to a number of patents, trademarks, copyrights, trade secrets, and other intellectual property. A listing of ON Semiconductor's product/patent coverage may be accessed at www.onsemi.com/site/pdf/Patent-Marking.pdf. ON Semiconductor reserves the right to make changes without further notice to any products herein. ON Semiconductor makes no warranty, representation or guarantee regarding the suitability of its products for any particular purpose, nor does ON Semiconductor assume any liability arising out of the application or use of any product or circuit, and specifically disclaims any and all liability, including without limitation special, consequential or incidental damages. Buyer is responsible for its products and applications using ON Semiconductor products, including compliance with all laws, regulations and safety requirements or standards, regardless of any support or applications information provided by ON Semiconductor. "Typical" parameters which may be provided in ON Semiconductor data sheets and/or specifications can and do vary in different applications and actual performance may vary over time. All operating parameters, including "Typicals" must be validated for each customer application by customer's technical experts. ON Semiconductor does not convey any license under its patent rights nor the rights of others. ON Semiconductor products are not designed, intended, or authorized for use as a critical component in life support systems or any FDA Class 3 medical devices or medical devices with a same or similar classification in a foreign jurisdiction or any devices intended for implantation in the human body. Should Buyer purchase or use ON Semiconductor products for any such unintended or unauthorized application, Buyer shall indemnify and hold ON Semiconductor and its officers, employees, subsidiaries, affiliates, and distributors harmless against all claims, costs, damages, and expenses, and reasonable attorney fees arising out of, directly or indirectly, any claim of personal injury or death associated with such unintended or unauthorized use, even if such claim alleges that ON Semiconductor was negligent regarding the design or manufacture of the part. ON Semiconductor is an Equal Opportunity/Affirmative Action Employer. This literature is subject to all applicable copyright laws and is not for resale in any manner.



FFG1040UC003X Single-Cell Fuel Gauge

Features

- Optional Battery Characterization Supported
- Typical Relative SOC Error ≈ 1%
- Support R_{SENSE} down to 3 mΩ to Reduce System Loss
- Low Power: <3 μA Shutdown Current
100 μA Active Current
- Integrated I²C Slave
- Interrupt Pin to Alert the Host Processor of System Events (e.g. Low Battery, Low SOC)
- Capable of measuring both on-die and battery pack temperature using external thermistor
- Host Side or Battery Pack Gauging Capable
- I²C relay Master to Support Secondary Slave
- Autonomous control of pack side FFG3105 battery monitor and ID with configurable auto polling
- Configurable I²C Inactivity Monitor for Auto Shutdown
- 12-ball Chip Scale Package (WLCSP)

Applications

- Cell Phones
- Mobile Devices
- Tablets

Description

The FFG1040 fuel gauge is a very accurate SOC reporting gauge designed to be used with cell phones, tablets and other portable devices. It uses a proprietary algorithm that tracks the battery to accurately report the Relative State-of-Charge (RSOC). The FFG1040 also reports User State-of-Charge (USOC), which is an adjusted RSOC value that is designed to be intuitive to the end user. The FFG1040 works with 1sXp (multiple parallel) battery configurations.

The FFG1040 includes an integrated temperature sensor that can be configured to read temperature from an external thermistor. The FFG1040 algorithm uses battery voltage, current and temperature to provide the most accurate State-of-Charge to a user. The temperature readings are accessible via I²C for other system level decision.

In addition to RSOC & USOC, the FFG1040 also reports battery voltage, current, capacity, cycle count and battery resistance.

The FFG1040 has the unique capability to relay I²C commands to a secondary slave device.

When used in autonomous mode the FFG1040 can directly control the FFG3105 pack side monitor and ID device and report the temperature and cell voltage information directly from the battery pack.

The FFG1040 utilizes a 3 x 4 ball, 0.5 mm pitch, WLCSP with nominal dimensions of 1.51 x 1.96 mm.

Ordering Information

Part Number	Operating Temperature Range	Package	Packing Method
FFG1040UC003X	-40 to 85°C	1.51 x 1.96 mm, 12-Ball CSP, 0.5 mm Ball Pitch	Tape and Reel

Ball Map

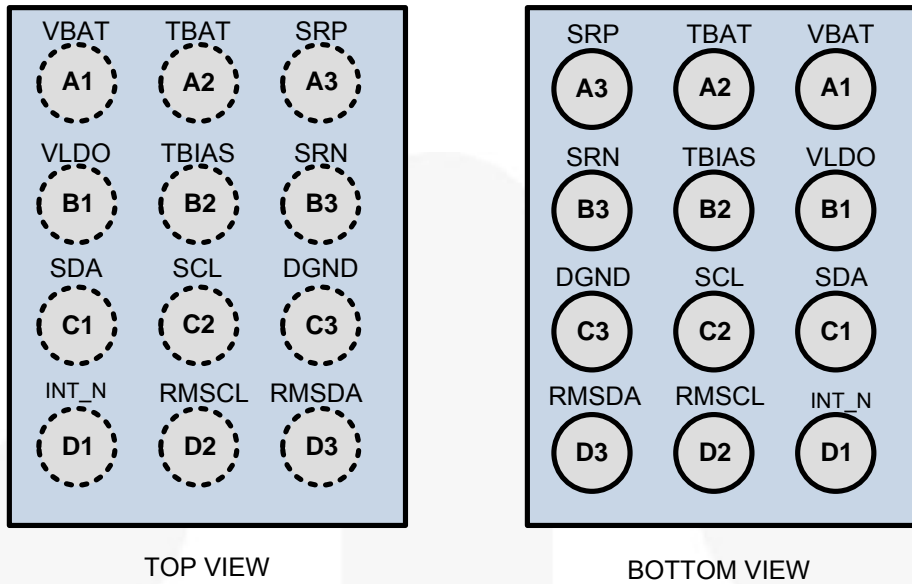

Figure 1. Ball Assignments

Ball Descriptions

Name	Position	Type	Description
VBAT	A1	Power	Battery positive voltage input.
TBIAS	B2	Analog Output	Thermistor sense circuit bias resistor output. R_{TN} should be the same value as the thermistor at room temperature. This pin should be left floating (not connected) if the NTC feature is not used. This pin should not be loaded with more than 1 nF of capacitance.
DGND	C3	Digital Ground	Ground
AGND/ SRN	B3	Analog Ground	Analog Ground and battery sense resistor negative input
SRP	A3	Analog Input	Sense resistor connection to negative battery terminal
TBAT	A2	Analog Input	Battery thermistor input. If the NTC feature is not used, this pin should be connected to GND.
INT_N	D1	Open Drain Digital Output	Interrupt output pin, LOW asserted. This pin should be connected to the VDD_IO through a pull-up resistor.
SCL	C2	Open Drain Digital I/O	I ² C clock input pin. This pin should be connected to the VDD_IO through a pull-up resistor.
SDA	C1	Open Drain Digital I/O	I ² C data I/O pin. This pin should be connected to the VDD_IO through a pull-up resistor.
VLDO	B1	Power	Internal LDO voltage. An external decoupling capacitor of at least 0.1 μ F should be connected between VLDO and GND. No external load should be connected to this pin.
RMSCL	D2	Open Drain Digital I/O	I ² C Relay Master SCL - RMSCL. This pin should be connected to the VBAT through a pull-up resistor.
RMSDA	D3	Open Drain Digital I/O	I ² C Relay Master SDA - RMSDA. This pin should be connected to the VBAT through a pull-up resistor.

Absolute Maximum Ratings

Stresses exceeding the absolute maximum ratings may damage the device. The device may not function or be operable above the recommended operating conditions and stressing the parts to these levels is not recommended. In addition, extended exposure to stresses above the recommended operating conditions may affect device reliability. The absolute maximum ratings are stress ratings only.

Symbol	Parameter	Min.	Max.	Unit
V _{BAT}	Positive Battery Supply Voltages	V _{GND} - 0.5	V _{GND} + 6.0	V
V _{SRP}	Negative Battery Supply Voltages	V _{GND} - 0.5	V _{GND} + 2.0	V
V _{LDO}	Positive Core Digital Supply Voltages	V _{GND} - 0.5	V _{GND} + 2.0	V
V _{GND}	Negative Analog Supply Voltage	V _{BAT} - 6.0	V _{BAT} + 0.5	V
V _{I/O}	All Digital Input / Output Signals	V _{DGND} - 0.5	V _{DGND} + 6.0	V
V _{TBAT}	Temperature Bridge Input Voltage	V _{SRP} - 0.5	V _{TBIAS} + 0.5	V
T _A	Operating Free-air Temperature	-40	+85	°C
T _{JMAX}	Maximum Junction Temperature	-40	+150	°C
T _{STG}	Storage Temperature Range	-65	+150	°C
T _L	Lead Soldering Temperature, 10 Seconds		+260	°C
ESD	Human-Body Model (HBM-JESD22-A114), All Pins	2000		V
	Charged Device Model (CDM-JESD22-C101)	500		V
	IEC 61000-4-2 System ESD ⁽¹⁾	Air Gap, V _{BAT} , T _{BAT}	15	kV
		Contact, V _{BAT} , T _{BAT}	8	kV

Note:

1. Testing is performed with a TVS device.

Recommended Operating Conditions

The Recommended Operating Conditions table defines the conditions for actual device operation. Recommended operating conditions are specified to ensure optimal performance to the datasheet specifications. Fairchild does not recommend exceeding them or designing to Absolute Maximum Ratings. The recommended operating conditions assume the following: V_{BAT} = 2.5 V to 4.5 V, V_{I/O} = 1.8 V to 4.5 V, T_A = -40°C to 85°C, unless otherwise noted.

Symbol	Parameter	Min.	Max.	Unit
V _{BAT}	Battery Supply Voltage ⁽²⁾	2.5	4.5	V
V _{SNP}	Sense Resistor Input Voltage	V _{AGND} - 0.052	V _{AGND} + 0.052	V
V _{TBAT}	Thermistor Bridge Input Voltage	V _{TBIAS} /2 - 0.5	V _{TBIAS} /2 + 0.5	V
V _{PU}	I ² C Pull-up Voltage	1.62	3.63	V
V _{BAT}	Battery Supply Voltage Slew Rate	0.4		V/ms
C _{VLDO}	External LDO Decoupling Capacitor between VLDO and DGND	90	110	nF
C _{TBIAS}	TBIAS Reference Decoupling Capacitor	420	520	nF
C _{TBAT}	TBAT filter Capacitor	200	250	nF
R _{SENSE}	External Sense Resistor between SRP and AGND ⁽³⁾	3	20	mΩ
V _{I_RANGE}	Current Sense Voltage Range	-51.2	+51.2	mV
R _{TBIAS}	Battery Thermistor Bias Resistance ⁽⁴⁾	1.5	100	kΩ
R _{I2CPU}	I ² C Pull up Resistor to V _{PU} (SDA, SCL, INT_N, RMSCL, RMSDA)	2	20	kΩ
T _A	Operating Free-air Temperature	-40	+85	°C
T _J	Operating Junction Temperature	-40	+85	°C

Notes:

2. V_{BAT} can tolerate ±200 mV system switching noise transients which are less than 50 μs in duration.
3. The value of the R_{SENSE} resistor should be chosen such that the maximum differential voltage across the resistor is less than 51 mV. This should include the voltage created by any peak currents.
4. A nominal value of R_{TBIAS} ≥ 10 kΩ is recommended to minimize thermistor temperature measurement current.

DC Electrical Characteristics

The Recommended Operating Conditions for DC Electrical Characteristics assume $V_{BAT} = 2.5\text{ V to }4.5\text{ V}$ and $T_A = -20^\circ\text{C to }70^\circ\text{C}$, unless otherwise noted. Typical values are at $T_A = 25^\circ\text{C}$, $V_{BAT} = 3.8\text{ V}$, $V_{PU} = 1.8\text{ V}$. Min./Max. values are guaranteed by design and/or characterization for process variations and the temperature range of $T_A = -20^\circ\text{C to }70^\circ\text{C}$.

Symbol	Parameter	Conditions	Min.	Typ.	Max.	Unit
VLDO	LDO Output Voltage	$V_{BAT} = 2.5\text{ to }4.5\text{ V}$, $CVLDO = 100\text{ nF}$	1.7	1.8	1.9	V
IIN	Input Leakage Current on Digital I/O pins	$V_{BAT} = 2.5\text{ to }4.5\text{ V}$, $0 \leq V_{IN} \leq V_{BAT}$		± 1		μA
IOFF	Power-Off IO Leakage Current	$V_{BAT} = 0$ V_{IN} or $V_{OUT} = 4.5\text{ V}$		± 1		μA
ICC	Shutdown Mode Average Current	$V_{IN} = V_{BAT}$ or GND		2.6		μA
	Rest/Off/Hibernate Mode Average Current			72		
	Active Mode Average Current ⁽⁵⁾			101		
	Autonomous Master ⁽⁵⁾			397		
SCL, SDA, INT_N Pins ($T_A = -40^\circ\text{C to }85^\circ\text{C}$)						
V_{IH}	Input High Voltage ⁽⁶⁾		1.1		$V_{PU}+0.5$	V
V_{IL}	Input Low Voltage ⁽⁶⁾		-0.50		0.65	V
V_{OL}	Output Low Voltage	$I_{OL} = 3\text{ mA}$, $V_{PU} > 2\text{ V}$			0.4	V
		$I_{OL} = 2\text{ mA}$, $V_{PU} \leq 2\text{ V}$			0.2	
I_{IN}	Input Current of SDA and SCL Pins	$0.1 \times V_{BAT} < V_{IN} < 0.9 \times V_{BAT}$	-10		10	μA
C_i	Capacitance of SDA and SCL Pins ⁽⁵⁾				10	pF
RMSCL and RMSDA Pins ($T_A = -40^\circ\text{C to }85^\circ\text{C}$)						
V_{IH}	Input High Voltage		$0.65 \times V_{BAT}$		V_{BAT}	V
V_{IL}	Input Low Voltage		V_{DGND}		$0.35 \times V_{BAT}$	V
V_{OL}	Output Low Voltage	Typical 1 mA			0.4	V
I_{IN}	Input Current of RMSDA Pin	$0.1 \times V_{BAT} < V_{IN} < 0.9 \times V_{BAT}$	-10		10	μA
C_i	Capacitance of RMSDAPin ⁽⁵⁾				10	pF

Continued on the following page...

DC Electrical Characteristics (Continued)

The Recommended Operating Conditions for DC Electrical Characteristics assume $V_{BAT} = 2.5\text{ V}$ to 4.5 V and $T_A = -20^\circ\text{C}$ to 70°C , unless otherwise noted. Typical values are at $T_A = 25^\circ\text{C}$, $V_{BAT} = 3.8\text{ V}$, $V_{PU} = 1.8\text{ V}$. Min./Max. values are guaranteed by design and/or characterization for process variations and the temperature range of $T_A = -20^\circ\text{C}$ to 70°C .

Symbol	Parameter	Conditions	Min.	Typ.	Max.	Unit
PGA/ADC Characteristics						
I_{GERR}	Current Sense Gain Error		-1.0		1.0	%
V_{GERR}	Voltage Sense Gain Error		-0.85		0.85	
Thermistor Characteristics						
T_{DIE}	Accuracy ⁽¹¹⁾	$T_A = +25^\circ\text{C}$	-2		+2	°C
		$T_A = +0^\circ\text{C}$ ⁽⁵⁾	-3		+3	
		$T_A = +50^\circ\text{C}$ ⁽⁵⁾	-3		+3	
		$T_A = -40^\circ\text{C}$ (T_{MIN}) ⁽⁵⁾	-4		+4	
		$T_A = +85^\circ\text{C}$ (T_{MAX}) ⁽⁵⁾	-4		+4	
T_{BAT_OFF}	TBAT Amplifier Offset Error		-4.0		+4.0	mV
T_{BAT_GERR}	TBAT Amplifier Gain Error	$T_A = -30$ to $+85^\circ\text{C}$	-0.75		+0.75	%
T_{BAT_LSB}	ADC TBAT Measurement LSB			31.2		μV

Notes:

- Guaranteed by design or characterization.
- SCL, SDA only.
- $V_{IH(max)} = V_{PU} + 0.5\text{ V}$ or V_{BAT} whichever is lower.
- It is assumed that the SCL, and SDA pins are open drain with external pull-ups resistors tied to an external supply V_{PU} .
- V_{IH} and V_{IL} have been chosen to be fully compliant to I²C specification at $V_{PU} = 1.8\text{ V} \pm 10\%$. At $2.25\text{ V} \leq V_{PU} \leq 3.63\text{ V}$ the $V_{IL(max)}$ provides $> 200\text{ mV}$ on noise margin to the required $V_{OL(max)}$ of the transmitter.
- I²C standard specifies $V_{OL(max)}$ for $V_{PU} \leq 2.0\text{ V}$ to be $0.2 \times V_{PU}$.
- Accuracy (expressed in °C) = the difference between the FFG1040 output temperature and the measured temperature.

AC Electrical Characteristics (I²C Controller SDA, SCL)

The AC electrical characteristics assume VBAT = 2.5 V to 4.5 V and T_A = -40°C to 85°C, unless otherwise noted. Min./Max. values are guaranteed by design and/or characterization for process variations and the temperature range of T_A = -40°C to 85°C.

Symbol	Parameter	Fast Mode		
		Min.	Max.	Unit
f _{SCL}	SCL Clock Frequency	0	400	kHz
t _{HD,STA}	Hold Time (Repeated) Start Condition	0.6		μs
t _{LOW}	Low Period of SCL Clock	1.3 ⁽¹²⁾		μs
t _{HIGH}	High Period of SCL Clock	0.6		μs
t _{SU,STA}	Set-up Time for Repeated Start Condition	0.6		μs
t _{HD,DAT}	Data Hold Time (see Figure 11)	0	0.9	μs
t _{SU,DAT}	Data Set-up Time (see Figure 11)	100 ⁽¹³⁾		ns
t _{PS}	Set-up Time Required by SDA Input Buffer (Receiving Data)	0		ns
t _{PH}	Out Delay Required by SDA Output Buffer (Transmitting Data)	300		ns
t _r	Rise Time of SDA and SCL Signals	20+0.1C _b ^(14,17)	300	ns
t _f	Fall Time of SDA and SCL Signals	20+0.1C _b ^(14,17)	300	ns
t _{SU,STO}	Set-up Time for Stop Condition	0.6		μs
t _{BUF}	Bus Free Time between a Stop and Start Conditions	1.3		μs
t _{SP}	Pulse Width of Spikes that Must Be Suppressed by the Input Filter	0	50	ns

Notes:

- The FFG1040 can accept clock signals with t_{LOW} as low as 1.1 μs, provided that the received SDA signal t_{HD,DAT} + t_{r/f} ≤ 1.1 μs. The FFG1040 features a 0 ns SDA input set-up time; therefore, this parameter is not included in the above equation.
- A Fast-Mode I2C Bus® device can be used in a Standard-Mode I2C bus system, but the requirement that t_{SU,DAT} ≥ 250 ns must be met. This is the case if the device does not stretch the LOW period of the SCL signal. If a device does stretch the LOW period of the SCL signal, it must output the next data bit to the SDA line t_{r_max} + t_{SU,DAT} = 1000 + 250 = 1250 ns (according to the Standard-Mode I2C Bus specification) before the SCL line is released.
- C_b equals the total capacitance of one bus line in pf. If mixed with High-Speed Mode devices, faster fall times are allowed according to the I2C specification.
- The FFG1040 ensures that the SDA signal out must coincide with SCL low for worst-case SCL t_f max. time of 300 ns. This requirement prevents data loss by preventing SDA-out transitions during the undefined region of the falling edge of SCL. Consequently, the FFG1040 fulfills the following requirement from the I2C specification (page 77, Note 2): "A device must internally provide a hold time of at least 300 ns for the SDA signal (referred to the V_{IHmin} of the SCL signal) to bridge the undefined region of the falling edge of SCL."
- FFG1040 I2C slave is fully compliant the NXP(Phillips) I2C specification, Rev. 0.3 UM10204 (2007) for both Standard Mode and Fast Mode.
- The FFG1040 does not support 1 Mbps/s Fast Mode Plus or 3.4 Mbits/s High Speed Mode.

System Applications Diagram

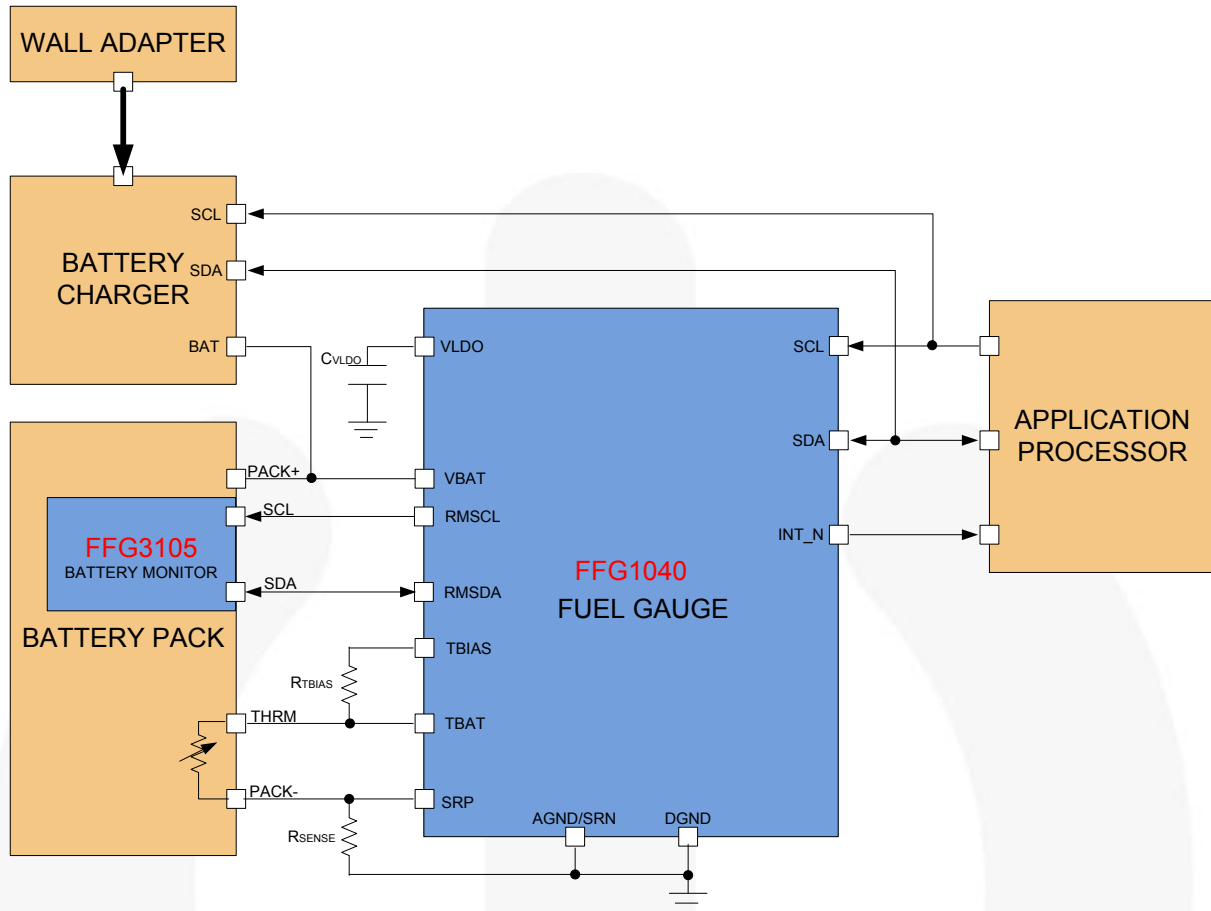

Figure 2. Applications Diagram

Functional Description

Overview

The FFG1040 uses an Analog-to-Digital Converter (ADC) to monitor the battery terminal voltage, battery current, and temperature to accurately provide RSOC and USOC values. With only general information provided about the selected batteries, the FFG1040 gives accurate results. The FFG1040 tracks and compensates for battery aging effects. This information is used by a proprietary prognostication algorithm to automatically compensate the SOC estimation. The FFG1040 also provides a low SOC and Zero SOC alert using the host interrupt pin. The Low_SOC_Alarm level is programmable as a function of the percentage of SOC. The FFG1040 has user programmable low-voltage, and over and under-temperature thresholds. When these limits are exceeded these events are reported to the host system using the interrupt pin.

Voltage Monitoring

The integrated ADC allows battery terminal voltage monitoring with a high degree of accuracy (< 1% error).

Current Monitoring

The FFG1040 uses differential sensing and an external sense resistor to monitor the current flowing in and out of the battery. Coulomb counting is performed using the highly accurate, digitally filtered ADC output and internal time base.

Relative State-of-Charge (RSOC) Error

Typical RSOC errors are $\pm 1\%$. The FFG1040 provides RSOC reporting error of less than $\pm 1\%$ while tracking actual load profiles.

Device Reset

The FFG1040 can be reset by the host processor using an I²C write command to a register. Upon this change, the FFG1040 is reset and all register values return to default values. In this case, the `fg_rdy_for_config_int` bit is set to 1 as soon as the reset sequence completes. Forcing it into SHUTDOWN can also reset the fuel gauge. See description of Mode below. Finally removing and reconnecting the VBAT supply can reset the device. Waking from reset is described below.

Power-Up, Leaving Reset or Leaving Shutdown

Upon receiving a valid Vbat supply or a device reset, the FFG1040 immediately powers the VBAT portion of the design and enter the SHUTDOWN state where it can monitor the I2C interface. The Host must wake up the fuel gauge by addressing it via I2C. The fuel gauge then wakes up and sets the **fg_rdy_for_config_int** bit in the SOC_INTERRUPTS register and the fuel gauge signals the host with an interrupt. The system driver can then use I2C commands to configure the fuel gauge registers. Once the registers have been configured the host writes a bit in the SOC_MODE register and the FFG1040 will start fuel gauging. The FFG1040 will then assert status in the SOC_STATUS register to indicate that it is fuel gauging.

After Gauging is Started

After completing the startup and configuration sequence the only registers that should be modified are the FG_RUNTIME_INPUT_CONFIG, FG_BATTERY_TEMP_RUNTIME_INPUT, SOC_INTERRUPT_MASKS, SOC_INTERRUPT_CLRS, and the SOC_MODE registers. All other registers should remain unchanged as they were programmed during device configuration. Once gauging has started performing writes to registers, 0x20 to 0x3F are disabled, Writes to the reserved FG_registers are also ignored while gauging. These registers cannot be updated until gauging has stopped.

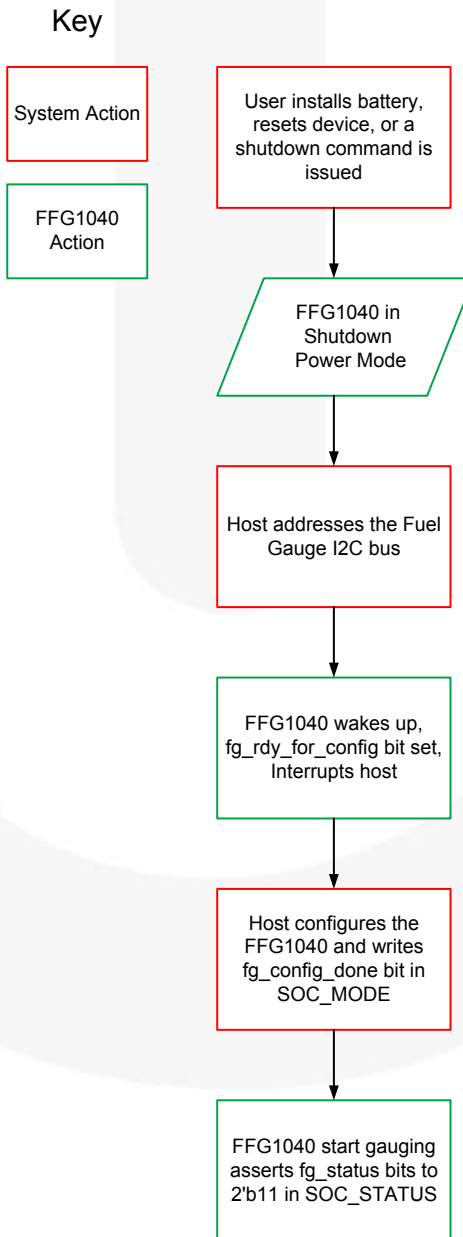

Figure 3. Power Up and Configuration Sequence

Power Modes

The FFG1040 chip has three configurable power modes. The host system requests the device to enter a power mode by writing bits in the SOC_MODE register. Following is a brief description of each of these modes:

Active Power Mode (ACTIVE)

In the ACTIVE mode the FFG1040 is able to actively monitor the battery voltage and current, run the algorithm, and communicate status and results to the system.

Hibernate Power Mode (HIBERNATE)

Registers can be accessed and read or written to in HIBERNATE. The AFE is not powered up and the FFG1040 processor is not clocking. During this mode internal state is retained for memory and registers.

Shutdown Power Mode (SHUTDOWN)

In SHUTDOWN, the FFG1040 is off. No fuel gauging or monitoring is taking place and no registers can be read or written in SHUTDOWN. In SHUTDOWN the internal state of the memory and registers is not maintained. Once in SHUTDOWN, the host can awaken the FFG1040 with an I²C read addressing the FFG1040 device. The FFG1040 does not acknowledge the read, but wakes up if V_{BAT} is available and transitions to ACTIVE. When this process is complete the FFG1040 interrupts the host processor letting it know that it is awake and ready to be configured by setting the **fg_rdy_for_config_int** bit in the SOC_INTERRUPTS register. The fuel gauge then interrupts the host. See Figure 3 above for configuration sequence.

Fuel Gauge SOC Reporting

State-of-Charge (SOC)

There are two types of SOC values reported by the fuel gauge. They are the RSOC and a USOC. The Relative SOC is accurate with respect to the present temperature and load conditions. USOC filters out rapid or unexpected changes in RSOC and adjusts RSOC to make sense to an end user.

Relative SOC (RSOC)

RSOC takes into account the battery load or charge current and the temperature to calculate the SOC as a function of usable capacity. The FFG1040 tracks recent battery usage to determine available capacity.

100% RSOC is reported during charging when the conditions for end of charge have been reached. This is when V_{bat} > (full charge voltage – margin), I_{bat} and I_{bat} Average are both > 0, and < charge complete current.

0% RSOC is reached when the average battery terminal voltage reaches the shutdown voltage. The impact of the system series resistances are also accounted for when this condition is determined

User SOC (USOC)

USOC is a filtered, rule based value. USOC filters RSOC so the results make sense to an end user. The USOC reported by the fuel gauge exhibits monotonic behavior during its charge or discharge trajectory as long as the sign of the average current flow remains constant.

For example: without a charger attached, the reported SOC cannot increase. User SOC rules are configurable. The following are the default set of rules governing USOC reporting:

When no charger is attached the phone status is discharging and the User SOC will never increase.

Abrupt changes in environmental and load conditions will not result in abrupt changes in USOC. USOC outputs cannot change more than the values programmed in the FG_USOC_CHG_SLEW_LIMIT and FG_USOC_DISCHG_SLEW_LIMIT.

1. 100% USOC is reported as a scaled value of RSOC where the upper bound is defined as 100% RSOC - FG_SOC_FS_DELTA. For example if FG_SOC_FS_DELTA=2% then the USOC=100% when RSOC >=98%.
2. When a charger is removed USOC will decrease proportionally to the load even if the RSOC level exceeds the USOC 100% threshold.
3. 0% USOC is the lower bound and is defined by the same rules as 0% RSOC.

Description of Status, Alarms and Interrupts

The following status bits and alarms appear in the FG_STATUS register and provide the host system with status of the battery management system.

Charger Present Status

Reports the charger attach status as provided by the system driver via the runtime input.

Discharging Status

If the battery is discharging the discharging bit is set.

Low Voltage Alarm

The FFG1040 has a low voltage alarm which uses the FG_LOW_VOLTAGE_SET register. This alarm is set when the average measured battery terminal voltage (FG_AVG_VOLTAGE) falls below the threshold set. The alarm is cleared when the battery terminal voltage rises above the value in the FG_LOW_VOLTAGE_CLEAR register.

This alarm generates an interrupt and sets the **fg_uv_int** bit in the SOC_INTERRUPTS register.

Temperature Out of Range Alarms

The fuel gauge notifies the system if the temperature exceeds the battery over-temperature or under-temperature user-defined thresholds set in the FG_BATTERY_TEMP_MAX and FG_BATTERY_TEMP_MIN registers. The FG_TEMPERATURE register provides an instantaneous value of the temperature as determined by the source (external thermistor, on die temperature, or host input) as specified in the FG_CONFIG register and is used to trigger this alarm. This alarm generates an interrupt and sets the **fg_ot_int** or **fg_ut_int** alarm in the SOC_INTERRUPTS register depending on the cause of the alarm.

Zero SOC Alarm

The Zero SOC alarm indicates that the battery has reached zero SOC following a discharge. The alarm can be triggered by either the RSOC or USOC value. Setting a bit in the FG_CONFIG register chooses the reference SOC value. This alarm generates an interrupt and sets the **fg_soc_zero_int** bit in the SOC_INTERRUPTS register.

Low SOC Alarm

The Low SOC alarm indicates that the battery has reached the Low SOC threshold during discharge. This alarm can be triggered by either the RSOC or USOC value. The reference SOC value is chosen by setting a bit in the FG_CONFIG register. This threshold is defined by the FG_LOW_SOC_THRESH register. The alarm generates an interrupt and sets the **fg_soc_ltsct_int** bit in the SOC_INTERRUPTS register. During charge when the SOC level exceeds the FG_LOW_SOC_THRESH level the **fg_soc_ltsct_int** bit in the SOC_INTERRUPTS register is set and a second interrupt is generated to inform the host that the low SOC state no longer exists.

High SOC Alarm

The High SOC alarm is set when the SOC has risen to or above the High SOC Threshold level in the FG_HIGH_SOC_THRESH register. It is cleared when the SOC has fallen 1% or more below the High SOC Threshold level. The SOC compared to the threshold can be the USOC or RSOC as determined by a bit in the FG_CONFIG register. Entry into this alarm condition will set the **fg_high_soc_int** bit in the SOC_INTERRUPTS register.

Almost Full Alarm

The Almost Full Alarm is set when the SOC approaches the full condition. This is provided to help the system know when the full condition is being approached. This alarm is reported when the average voltage is above the FG_FULL_VOLTAGE and both the current and average current are positive but below the charge termination current configured in FG_I_CHG_COMPLETE plus some margin.

Limit Check Alarm

This alarm is set and the gauge function stopped when any of the following exceed their specified bounds: FG_VOLTAGE, FG_AVG_VOLTAGE, FG_CURRENT, FG_AVG_CURRENT, FG_TEMPERATURE, FG_DIE_TEMPERATURE, FG_FULL_CHARGE_CAPACITY_NOM, FG_FULL_CHARGE_CAPACITY, and FG_R0_NOM. Entry into this alarm condition will set the **fg_limit_check_int** bit in the SOC_INTERRUPTS register and the reason for the alarm is stored in FG_SW_ERR_CODE. The gauge function is stopped and the FFG1040 transitions into the HIBERNATE power state when this alarm is asserted.

Battery Present Alarm

The Battery Present Alarm reports the state of battery presence as provided by the system driver via the runtime input.

Fuel Gauging Status

The Device Status bits indicate if the algorithm is in the Device Active (11), Device Resting (10) or the Device Off (01) state. The fuel gauge activity status is determined by the values set in the FG_REST_TIME, FG_REST_CURRENT, and FG_OFF_CURRENT registers. Figure 4 describes how the fuel gauge transitions between each of these states. (Note the device must be ACTIVE Power Mode and Gauging must be enabled before the algorithm can be started and thus enter into any of these states). When the FFG1040 enters the Device Resting and Device Off states the data acquisition rate of the gauge and the SOC calculations are slowed to a lower rate.

Watch Dog Timer (WDT)

Internal to the FFG1040 there is a watch dog timer that tracks the progress of system and the fuel gauging engine. If this progress is interrupted for any reason, causing the internal the WDT to expire the **fg_wdt_int** bit will be set in the SOC_INTERRUPTS register.

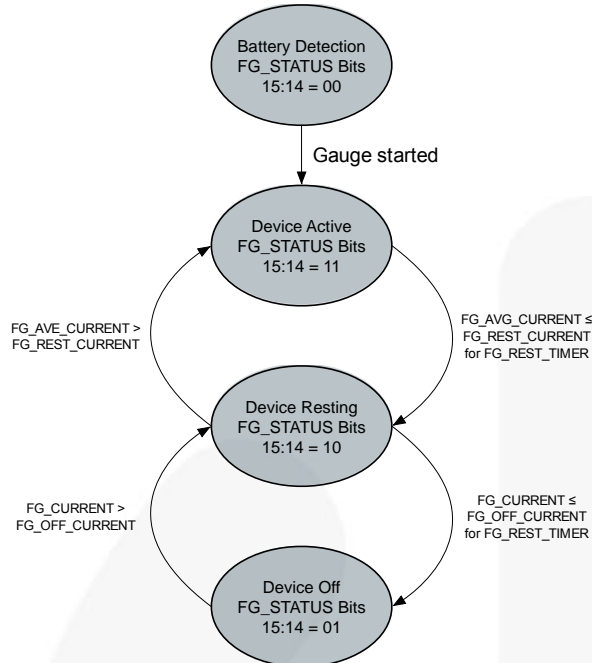

Figure 4. Gauging Modes

Interrupt Operation

The **INT_N** pin is an active LOW-asserted, open-drain output that requires an external pull-up resistor to V_{PU} . The FFG1040 uses this pin to signal an interrupt to the processor or any external device when an event occurs. For example: immediately after detecting a low battery voltage, the FFG1040 writes the corresponding bit in the **SOC_INTERRUPTS** register and asserts the **INT_N** pin by pulling it LOW. The **SOC_INTERRUPTS** register bit remains HIGH until the host processor writes a 1 to the corresponding bit in the **SOC_INTERRUPT_CLRS** register. The FFG1040 uses a „write 1 to clear“ scheme. Interrupts are edge-triggered events. The interrupt output **INT_N**, once asserted, is held LOW until all the interrupts are serviced and cleared by the external processor. Interrupt signaling is asynchronous to the I²C SCL line. All interrupts are by default enabled. Each interrupt has a corresponding mask bit and clear bit in the **SOC_INTERRUPT_MASKS** and **SOC_INTERRUPT_CLRS** registers. The host system may disable individual interrupts by writing the corresponding mask bit for each interrupt in the **SOC_INTERRUPT_MASKS** register.

In all, there are 16 interrupts with mask and clear bits.

Interrupt Bits

The following interrupt bits are contained in the **SOC_INTERRUPTS** register and reported to the host.

- Bit 0 – **fg_ot_int** – Over-Temperature Interrupt
- Bit 1 – **fg_pack_commerr_int** – Pack Comm Error Interrupt
- Bit 2 – **fg_uv_int** – Under-Voltage Interrupt
- Bit 3 – **fg_high_soc_int** – High SOC
- Bit 4 – **fg_ut_int** – Under-Temperature Interrupt
- Bit 5 – **fg_heartbeat** – Heart Beat Interrupt
- Bit 6 – **fg_limit_check** – Limit Check Interrupt
- Bit 7 – **fg_soc_zero_int** – Zero SOC Interrupt
- Bit 8 – **fg_soc_ltset_int** – Low Threshold Set Interrupt
- Bit 9 – **fg_soc_ltblr_int** – Low Threshold Clear Interrupt
- Bit 10 – **fg_soc_active_int** – Active Interrupt
- Bit 11 – **fg_rdy_for_config_int** – Ready for Config Interrupt
- Bit 12 – **fg_wdt_int** – Watch Dog Timer Interrupt
- Bit 13 – **fg_i2cmstr_int** – I²C Master Interrupt
- Bit 14 – **fg_almost_full_int** – Almost Full Interrupt
- Bit 15 – **fg_pack_voltage_int** – Pack Voltage Interrupt

Each interrupt bit has a corresponding mask bit and clear bit in the **SOC_INTERRUPT_MASKS** and **SOC_INTERRUPT_CLRS** registers respectively.

Fuel Gauge Configurations and Features

Save and Restore Feature

The FFG1040 has a feature which improves fuel-gauging startup performance immediately after removing and reinserting the same battery. This feature is called the „save and restore“ feature and allows the fuel gauge to resume gauging from where it left off prior to battery removal, provided the same battery is reinserted. If the system designer chooses to use this feature, the host processor saves off the values in the Save and Restore registers, 0x65-0x71 at some interval. The recommended interval is once per 1% change in SOC state or once every 10 minutes when the gauge is in the Active Device state and once per hour when the gauge is in the Resting device state. After each and every fuel gauge reset the driver configures the fuel gauge by writing the recently stored values from system memory back into the fuel gauge Save and Restore registers. When started, the fuel gauge algorithm determines if the newly inserted battery is the same battery that was most recently gauged. If so it uses the restored values allowing the fuel gauge to benefit from past learning to more accurately report the RSOC of the reinserted battery. For systems with a captive battery, the learned battery parameters can be restored by setting a bit in the FG_CONFIG register before starting the gauge.

Temperature Sensing and Reporting

The FFG1040 has three possible methods to obtain temperature information used by the fuel-gauging algorithm. The first method is to measure an external thermistor using the onboard ADC and the **TBAT** pin. The FFG1040 supports connecting an external thermistor and provides the appropriate bias voltage, V_{TBIAS} , from the **TBIAS** pin for the thermistor network. The second method uses the fuel gauge’s internal temperature-sensing capability. In both of these cases, the system can read the measured temperature from the FG_TEMPERATURE register. The third method is for the system to provide a temperature reading to the fuel gauge by writing to the fuel gauge FG_BATTERY_TEMP_RUNTIME_INPUT register.

By default, the FFG1040 measures the internal temperature using its onboard temperature sensor. It measures and reports this value once every 10 seconds in the “Device Active” state and once every 20 seconds in the “Device Resting” state and uses this value as an input to the fuel gauge algorithm. For batteries or systems with a thermistor available, the FFG1040 can measure temperature using the thermistor as requested by setting the appropriate bit in the FG_CONFIG register. Additionally, the thermistor Beta value must be set in the FG_BATTERY_THERM_TEMP_CO register, to configure temperature calculation.

Relay Master

In this mode the system level host, which controls the FFG1040, can use a series of register to “relay” I²C read and write commands to the relay master port. This port contains its own Relay Master Serial Clock (**RMSCL**), and Relay Master Serial Data (**RMSDA**). The system host sends and receives data from a downstream slave(s) connected to these two pins.

The relay master relies on the I2C_MSTR_ set of registers. These registers are a subset of the registers included in the FFG1040. The registers use the last seven addresses of the register space (0xF9-0xFF).

Autonomous Master

In this mode, the FFG1040, utilizes its internal firmware and controls the FFG3105 to read the battery cell voltage and pack temperature. This is done to reduce the system host involvement during critical times like battery charging, where knowing the cell voltage and temperature improve the charging process. The FFG1040 will accept as configuration inputs a pack alarm voltage, a pack polling rate voltage, a slow poll rate interval in 50 ms steps, a fast poll rate interval in 50 ms steps, and a maximum battery temperature. Once given a start signal, the FFG1040 I²C master capability is used to trigger measurements by the FFG3105 to read the voltage and temperature and report them in output registers. If the voltage is below the polling rate voltage then the next reading will occur after the slow interval, otherwise it will occur after the fast interval.

Polling will continue until either;

- a) A stop signal is given
- b) The battery temperature exceeds the maximum temperature
- c) The battery voltage exceeds the alarm voltage
- d) A communication error occurs on the I²C interface between the FFG1040 and the FFG3105
- e) The FFG3105 does not respond with a valid temperature/voltage within 100 ms of the measurement trigger.

While polling is active the host cannot trigger I²C relay master transactions. Host writes to the I²C master register space will corrupt on-going transactions. A status bit is set to indicate to the host that automatic polling is in progress and I²C Master functionality is not currently available.

Upon termination of polling, an interrupt is set to indicate polling ceased due to a voltage or temperature alarm, and a second interrupt is set to indicate polling ceased due to a communication error or FFG3105 timeout.

I²C Interface

The FFG1040's serial interface is compatible with Standard and Fast I²C bus specifications. The FFG1040's **SCL** line is an input and its **SDA** line is a bi-directional open-drain output; it can only pull down the bus when active. The **SDA** line only pulls LOW during data reads and when signaling ACK. All data is shifted in MSB (bit 7) first.

The FFG1040UC003X uses power from the VBAT node to power itself. When the battery is removed and the VBAT node is pulled low, the fuel gauge will hold **SDA**, **SCL** and **INT_N** low. Thus if the mobile device is expected to operate from a charger even if the battery is removed, it is recommended to connect the **SDA** and **SCL** to a separate I2C bus and the **INT_N** pin to its own GPI on the system processor. Please contact your Fairchild representative for questions pertaining to operation without a battery.

Slave Address

The FFG1040 slave address in hex notation is 0x70 = 01110000; where the device is addressed assuming a 0 LSB. This is the 7-bit slave address followed by the read/write bit. To read from the device, use 01110001, and to initiate a write, use 01110000.

Table 1. I²C Slave Address Byte

Bit	7	6	5	4	3	2	1	0
Value	0	1	1	1	0	0	0	R/W

Other slave addresses can be accommodated upon request. Contact your Fairchild representative.

Bus Timing

As shown in Figure 5, data is normally transferred when **SCL** is LOW. Data is clocked in on the rising edge of **SCL**. Typically, data transitions at or shortly after the falling edge of **SCL** to allow ample time for the data to set up before the next **SCL** rising edge.

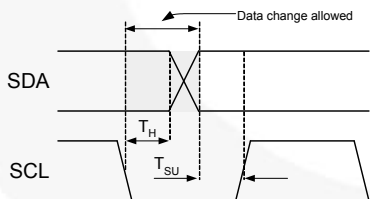

Figure 5. Data Transfer Timing

Each bus transaction begins and ends with **SDA** and **SCL** HIGH. A transaction begins with a START condition, which is defined as **SDA** transitioning from 1 to 0 with **SCL** HIGH.

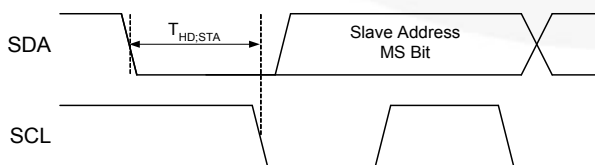

Figure 6. START Bit

A transaction ends with a STOP condition, which is defined as **SDA** transitioning from 0 to 1 with **SCL** HIGH.

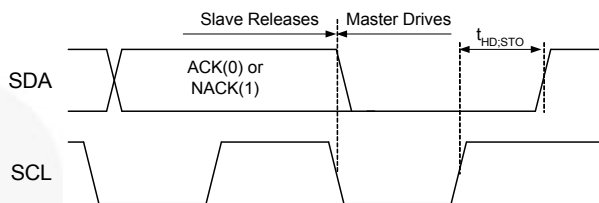

Figure 7. STOP Bit

During a read from the FFG1040, the master issues a Repeated Start after sending the register address and before resending the slave address. The Repeated Start is a 1-to-0 transition on **SDA** while **SCL** is HIGH.

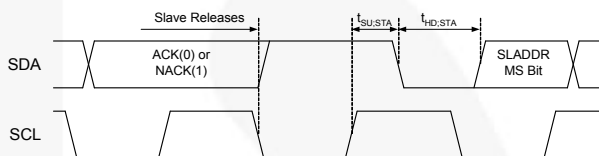

Figure 8. Repeated STOP Timing

I²C Slave Inactivity

The FFG1040 contains an inactivity timer that monitors the slave interface. If the time between I²C writes to the device exceeds the value set in the FG_INACTIVITY_RESET_TIME the part will put itself into the SHUTDOWN state. This feature acts like a “keep alive” where the host system must do a write to the FFG1040 to prevent it from going into shutdown. Setting a bit in the FG_CONFIG register enables this feature.

A write to any register in the address range 0x40 to 0xFF is sufficient to reset the timer. It's suggested that the FG_RUNTIME_INPUT_CONFIG or FG_RUNTIME_TEMPERATURE registers be used as the registers to be written by the host as these are normally run-time written registers. Reads from any register or writes to any registers outside of the address range 0x40 to 0xFF will not cause the timer to be reset, so they do not count as I²C activity for this feature.

I²C Master

The FFG1040 contains firmware that allows the device to use the RMSCL and RMSDA pins to communicate with external I²C slaves. This interface is mastered by the FFG1040 in two different ways. The first, a more general use is as a “Relay Master”. The second, the FFG3105 specific mode is as an “Autonomous Master”. The external system host can enable the FFG1040 to use either of these modes and can control which mode the FFG1040 is in.

Refer to the FFG1040 Users Reference Manual for a detailed description of this functionality.

I²C Read Write Procedures

Figure 9 and Figure 10 illustrate compatible I²C write and read sequences. Register addresses are one byte (8-bits) and register data is 2 bytes (16-bits).

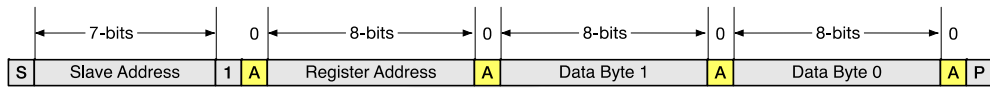

Note: Single register read is initiated by Master with P immediately following second data byte

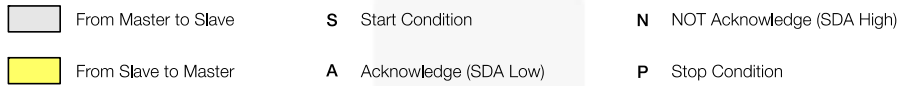
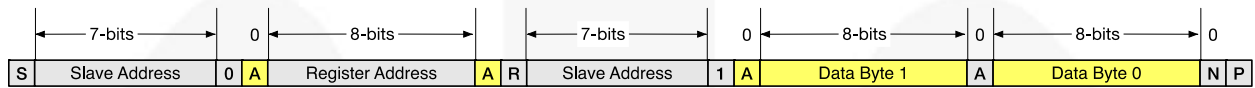

Figure 9. I²C Write Sequence



Note: Register address to read is specified with write. If register is not specified Master will begin read from the current register.

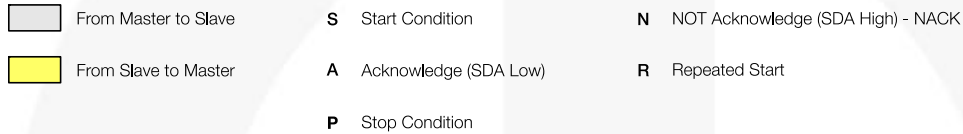

Figure 10. I²C Read Sequence

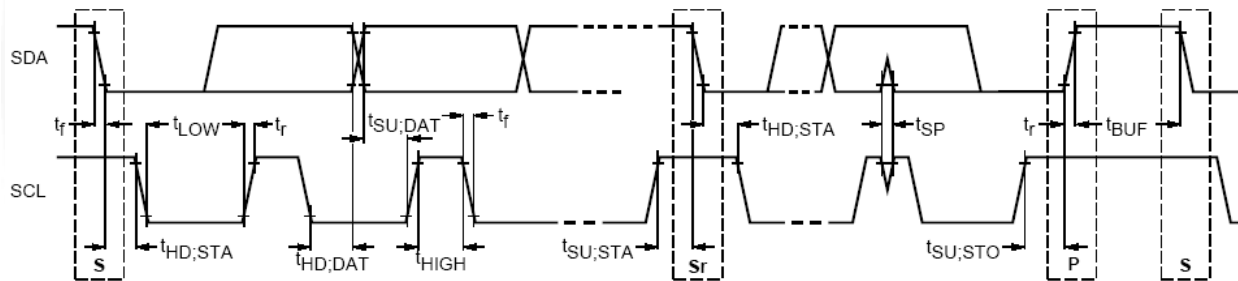

Figure 11. Definition of Timing for Full-Speed Mode Devices on the I²C Bus

Register Information

The Fuel Gauge has registers that are used to configure it and provide information to an external host. These registers are accessible to the host through the I²C slave controller and defined below. Any registers or bit fields marked as RESERVED or reserved should be left at their default values and not modified.

Table 2. Register Map

Name	Address	Type	Description
System on Chip (SoC) Registers			
SOC_MODE	0x00	R/W	SoC Mode for power mode control
SOC_STATUS	0x01	RO	SoC Status
SOC_INTERRUPTS	0x0A	RO	Interrupt Status
SOC_INTERRUPT_MASKS	0x0B	R/W	Interrupt Mask
SOC_INTERRUPT_CLRS	0x0C	R/W/S C	Interrupt Clear
SOC_PART_ID	0x0F	RO	Part ID
AFE_OSC_TRIM	0x2C	R/W	AFE Configuration
Fuel Gauge System Related Driver Configuration Registers			
FG_CONFIG	0x40	R/W	Configuration Options
FG_RSENSE_RESISTANCE	0x42	R/W	Sense Resistor Value in Ohms
FG_FULL_VOLTAGE	0x43	R/W	Full OCV Voltage Level
FG_VOLTAGE_SHUTDOWN	0x44	R/W	System Shutdown Voltage
FG_BATTERY_THERM_TEMPCO_LSW/MSW	0x46-0x47	R/W	Thermistor Temperature Coefficient
FG_VOFFSET_CORRECTION_LSW/MSW	0x48-0x49	R/W	AFE Voltage Correction Factor
FG_IOFFSET_CORRECTION_LSW/MSW	0x4A-0x4B	R/W	AFE Current Offset Correction Factor
FG_PACK_ALARM_VOLTAGE	0x4C	R/W	Pack Alarm Voltage (mV)
FG_PACK_POLLRATE_VOLTAGE	0x4D	R/W	Voltage threshold for determining pack poll rate (mV)
FG_RSERIES_ADJ_LSW/MSW	0x4E-0x4F	R/W	Rsense Adjustment Factor
FG_REST_CURRENT	0x50	R/W	Rest Current Threshold (mA)
FG_REST_TIME	0x51	R/W	Min. duration to be considered at rest (s)
FG_OFF_CURRENT	0x52	R/W	Current threshold used to determine if the load is inactive (mA)
FG_USOC_CHG_SLEW_LIMIT	0x53	R/W	USOC Slew Rate Limit during Charge
FG_USOC_DISCHG_SLEW_LIMIT	0x54	R/W	USOC Slew Rate Limit during Discharge
FG_USOC_FS_DELTA	0x55	R/W	Full Scale Delta for 100% USOC Calc (%)
FG_USOC_0ERR_PT	0x56	R/W	Set point for discharge scaling from full charge (%)

Continued on the following page...

Name	Address	Type	Description
Fuel Gauge Alarm Configuration Registers			
FG_LOW_VOLTAGE_SET	0x57	R/W	Low Voltage Alarm Set Threshold (mV)
FG_LOW_VOLTAGE_CLEAR	0x58	R/W	Low Voltage Alarm Clear Threshold (mV)
FG_HIGH_SOC_THRESH	0x59	R/W	High SOC Alarm Threshold (%)
FG_BATTERY_TEMP_MAX	0x5A	R/W	Max. Temperature Alarm Level (0.1°C)
FG_BATTERY_TEMP_MIN	0x5B	R/W	Min. Temperature Alarm Level (0.1°C)
FG_LOW_SOC_THRESH	0x5C	R/W	Threshold for Low SOC Alarm (%)
Fuel Gauge Run Time Input Registers			
FG_RUNTIME_INPUT_CONFIG	0x5D	R/W	Run Time Configuration Options
FG_BATTERY_TEMP_RUNTIME_INPUT	0x5E	R/W	Run Time Temperature Value Input (0.1°C)
Fuel Gauge Output Registers			
FG_STATUS	0x5F	R/W ⁽¹⁸⁾	Output Status and Alarm bits
FG_CURRENT	0x60	R/W ⁽¹⁸⁾	Instantaneous Battery Current (mA)
FG_VOLTAGE	0x61	R/W ⁽¹⁸⁾	Instantaneous Battery Voltage (mV)
FG_TEMPERATURE	0x62	R/W ⁽¹⁸⁾	Instantaneous Temperature (0.1°C)
FG_FULL_CHARGE_CAPACITY	0x63	R/W ⁽¹⁸⁾	Full-charge Capacity at Current Temperature (mAh)
FG_FIRMWARE_REV	0x64	R/W ⁽¹⁸⁾	Firmware Revision
FG_CC	0x71	R/W ⁽¹⁸⁾	Coulomb count output
FG_DIE_TEMPERATURE	0xDB	R/W ⁽¹⁸⁾	Die Temperature
FG_SW_ERR_CODE	0xF1	R/W ⁽¹⁸⁾	Software Error Codes for diagnostics
Fuel Gauge Save and Restore Registers			
FG_AVG_CURRENT	0x65	R/W ⁽¹⁹⁾	Average Battery Current (mA)
FG_AVG_VOLTAGE	0x66	R/W ⁽¹⁹⁾	Average Battery Voltage (mV)
FG_RSOC	0x67	R/W ⁽¹⁹⁾	Relative State-of-Charge (%)
FG_USOC	0x68	R/W ⁽¹⁹⁾	User State-of-Charge (%)
FG_FULL_CHARGE_CAPACITY_NOM	0x6A	R/W ⁽¹⁹⁾	Measured Full Charge Capacity at 25°C (mAh)
FG_CYCLE_COUNT	0x6B	R/W ⁽¹⁹⁾	Battery Cycle Counter
FG_R0_NOM	0x6C	R/W ⁽¹⁹⁾	Measured Battery Resistance at 25°C
Fuel Gauge Driver Configured Algorithm Inputs			
FG_R0_INIT	0x72	R/W	Nominal battery resistance seed value for algorithm (mΩ)
FG_QCAPACITY_DESIGN	0x73	R/W	Nominal battery capacity per manufacturer (mAh)
FG_ICHG_COMPLETE	0x74	R/W	Charge Current Complete (mA)
FG_AUTO_SD_VOLTAGE	0xCD	R/W	Auto Shutdown Voltage Threshold (mV)
FG_CAPEST_STARTING_RATIO	0xD0	R/W	Scaling Ratio for Design Capacity
FG_RSOC_SD_CAP	0xE3	R/W	Max. RSOC Relaxation at Shutdown

Continued on the following page...

Name	Address	Type	Description
Fuel Gauge Driver Configured Algorithm Inputs (Continued)			
To be supplied by Fairchild	0x75-0xCC, 0xCE-0xCF, 0xD1-0xDA, 0xDC-0xE2 0xE4-0xF0 0xF2-0xF5,	R/w	Algorithm configuration parameters supplied by Fairchild for driver.
FG_I2C_INACTIVE_RESET_TIME	0xF6	R/W	Time between I ² C writes to device before inactivity reset if enabled (s)
FG_TYPICAL_LOAD	0xF8	R/W	Load used for RSOC during Charging (mA)
I2C_MSTR_CONTROL	0xF9	R/W	I2C Relay Master Control
I2C_MSTR_CONFIG	0xFA	R/W	I2C Relay Master Configuration
I2C_MSTR_STATUS	0xFB	R/W ⁽¹⁸⁾	I2C Relay Master status
I2C_MSTR_DATA0	0xFC	R/W	I2C Relay Master Data Byte 0
I2C_MSTR_DATA1	0xFD	R/W	I2C Relay Master Data Byte 1
I2C_MSTR_DATA2	0xFE	R/W	I2C Relay Master Data Byte 2
I2C_MSTR_DATA3	0xFF	R/W	I2C Relay Master Data Byte 3

Notes:

18. Device output register. Writes to this register have no effect on internal operation and values will be over-written by the device normal operation.
19. Save and restore input/output register. Values should only be written to these registers before gauging is started. After the gauge has been started writes to this register have no effect on internal operation, but values will be over-written by the device normal operation.

Table 3. Register Type Description

Mnemonic	Type	Description
RO	Read Only	These registers are read only. Their values are updated only by internal hardware
R/W	Read/Write	These registers can be written or read
RW/SC	Read/Write/Self Clear	These register bits self clear to a 1'b0 after being written 1'b1.
R	Read	These registers should only be read. Attempting a write may cause unpredictable behavior

Detailed Interrupt and Alarm Register Definitions

Detailed bit descriptions for select registers are included in this section. For a complete description of all register bit mappings, refer to the FFG1040 Users Reference Manual.

Interrupt Requests (SOC_INTERRUPTS)

Table 4. SoC Interrupts Register

SOC_INTERRUPTS (0x0A)						DataType = 16bit		
Bit Location	15	14	13	12	11	10	9	8
Parameter	fg_pack_voltage_int	fg_almost_full_int	fg_i2cmstr_int	fg_wdt_int	fg_rdy_for_config_int	fg_active_int	fg_soc_ltlcr_int	fg_soc_ltlset_int
Default	0	0	0	0	0	0	0	0
Type	RO	RO	RO	RO	RO	RO	RO	RO
SOC_INTERRUPTS (0x0A)								
Bit Location	7	6	5	4	3	2	1	0
Parameter	fg_soc_zero_int	fg_limit_check_int	fg_heartbeat_int	fg_ut_int	fg_high_soc_int	fg_uv_int	Fg_pack_commerr_int	fg_ot_int
Default	0	0	0	0	0	0	0	0
Type	RO	RO	RO	RO	RO	RO	RO	RO

Bit(s)	Name	Description
0	fg_ot_int	Fuel Gauge Over-Temperature (OT) Interrupt 0 = cleared, 1 = Set when battery pack is over-temperature
1	fg_pack_commerr_int	Fuel Gauge Pack Communications Error Interrupt 0 – cleared, 1 – Set when I2C error using internal master
2	fg_uv_int	Fuel Gauge Under-Voltage (UV) Interrupt 0 = cleared, 1 = set when battery pack experiences under-voltage
3	fg_high_soc_int	Fuel Gauge High SOC Interrupt 0 = cleared, 1 = set when SOC meets or exceeds the alarm threshold
4	fg_ut_int	Fuel Gauge Under-Temperature (UT) Interrupt 0 – cleared, 1 = Set when battery pack is under-temperature Description: This bit is set when an Under-Temperature Alarm is declared.
5	fg_heartbeat_int	Fuel Gauge Heart Beat Interrupt 0 = cleared, 1 = set by fuel gauge firmware
6	fg_limit_check_int	Fuel Gauge Limit Check Interrupt 0 = cleared, 1 = set when limit check threshold is crossed.
7	fg_soc_zero_int	Fuel Gauge Zero SOC Interrupt 0 = cleared, 1 = set by when Zero SOC alarm is declared
8	fg_soc_ltset_int	Fuel Gauge SOC Low Threshold Set Interrupt 0 = cleared, 1 = set when SOC has met or fallen below the FG low State-Of-Charge threshold
9	fg_soc_lclr_int	Fuel Gauge SOC Low Threshold Clear Interrupt 0 = cleared, 1 = set when SOC rises back above the FG Low State-Of-Charge threshold
10	fg_active_int	Fuel Gauge Active Interrupt 0 = cleared, 1 = set when fuel gauge is active.
11	fg_rdy_for_config_int	Fuel Gauge Ready for Configuration 0 = cleared, 1 = set when fuel gauge ready for configuration
12	fg_wdt_int	Fuel Gauge Watch Dog Timer Interrupt 0 = cleared, 1 = set when fuel gauge WDT has expired
13	fg_i2cmstr_int	Fuel Gauge I2C Master Interrupt 0 = cleared. 1 = set when I2C master transaction completed
14	fg_almost_full_int	Fuel Gauge Almost Full Interrupt 0 = cleared, 1 = set when SOC Almost Full
15	fg_pack_voltage_int	Fuel Gauge Pack Voltage Interrupt 0 = cleared, 1 = set when pack voltage exceeds threshold

Interrupt Masks (SOC_INTERRUPT_MASKS)

Table 5. SoC Interrupt Masks Register

SOC_INTERRUPT_MASKS (0x0B)						DataType = 16bit		
Bit Location	15	14	13	12	11	10	9	8
Parameter	fg_pack_voltage_intm	fg_almost_full_intm	fg_i2cmstr_intm	fg_wdt_intm	fg_rdy_for_config_intm	fg_active_intm	fg_soc_ltclr_intm	fg_soc_ltset_intm
Default	0	0	0	0	0	0	0	0
Type	R/W	R/W	R/W	R/W	R/W	R/W	R/W	R/W
SOC_INTERRUPT_MASKS (0x0B)								
Bit Location	7	6	5	4	3	2	1	0
Parameter	fg_soc_zero_intm	fg_limit_check_intm	fg_heartbeat_intm	fg_ut_intm	fg_high_soc_intm	fg_uv_intm	fg_pack_comer_intm	fg_ot_intm
Default	0	0	0	0	0	0	0	0
Type	R/W	R/W	R/W	R/W	R/W	R/W	R/W	R/W

Bit(s)	Name	Description
0	fg_ot_intm	Fuel Gauge Over-Temperature (OT) Interrupt Mask 0 = interrupt enabled, 1 = interrupt masked
1	fg_pack_commerr_intm	Fuel Gauge Pack Communications Error Interrupt Mask 0 = interrupt enabled, 1 = interrupt masked
2	fg_uv_intm	Fuel Gauge Under-Voltage (UT) Interrupt Mask 0 = interrupt enabled, 1 = interrupt masked
3	fg_high_soc_intm	Fuel Gauge High SOC Interrupt Mask 0 = interrupt enabled, 1 = interrupt masked
4	fg_ut_intm	Fuel Gauge Under-Temperature (UT) Interrupt Mask 0 = interrupt enabled, 1 = interrupt masked
5	fg_heartbeat_intm	Fuel Gauge Heart Beat Interrupt Mask 0 = interrupt enabled, 1 = interrupt masked
6	fg_limit_chk_intm	Fuel Gauge Limit Check Interrupt Mask 0 = interrupt enabled, 1 = interrupt masked
7	fg_soc_zero_intm	Zero SOC Interrupt Mask 0 = interrupt enabled, 1 = interrupt masked
8	fg_soc_ltset_intm	SOC Low Threshold Set Interrupt Mask 0 = interrupt enabled, 1 = interrupt masked
9	fg_soc_ltclr_intm	SOC Low Threshold Clear Interrupt Mask 0 = interrupt enabled, 1 = interrupt masked
10	fg_active_intm	Fuel Gauge Active Interrupt Mask 0 = interrupt enabled, 1 = interrupt masked
11	fg_rdy_for_config_intm	Fuel Gauge Ready for Config Interrupt Mask 0 = interrupt enabled, 1 = interrupt masked
12	fg_wdt_intm	Fuel Gauge Watch Dog Timer Interrupt Mask 0 = interrupt enabled, 1 = interrupt mask
13	fg_i2cmstr_intm	I2C Master Interrupt Mask 0 = interrupt enabled, 1 = interrupt masked
14	fg_almost_full_intm	Fuel Gauge Almost Full Interrupt Mask 0 = interrupt enabled, 1 = interrupt masked
15	fg_pack_voltage_intm	Fuel Gauge Pack Voltage Interrupt Mask 0 = interrupt enabled, 1 = interrupt masked

Interrupt Clears (SOC_INTERRUPT_CLRS)

Table 6. SoC Interrupt Clears Register

SOC_INTERRUPT_CLRS (0x0C)						DataType = 16bit		
Bit Location	15	14	13	12	11	10	9	8
Parameter	fg_pack_voltage_int_clr	fg_almost_full_int_clr	fg_i2cmstr_int_clr	fg_wdt_int_clr	fg_rdy_for_onfig_int_clr	fg_active_int_clr	fg_soc_ltclr_int_clr	fg_soc_ltset_int_clr
Default	0	0	0	0	0	0	0	0
Type	RW/SC	RW/SC	RW/SC	RW/SC	RW/SC	RW/SC	RW/SC	RW/SC
SOC_INTERRUPT_CLRS (0x0B)								
Bit Location	7	6	5	4	3	2	1	0
Parameter	fg_soc_zero_int_clr	fg_limit_check_int_clr	fg_heartbeat_int_clr	fg_ut_int_clr	fg_high_soc_int_clr	fg_uv_int_clr	fg_pack_commerr_int_clr	fg_ot_int_clr
Default	0	0	0	0	0	0	0	0
Type	RW/SC	RW/SC	RW/SC	RW/SC	RW/SC	RW/SC	RW/SC	RW/SC

Bit(s)	Name	Description
0	fg_ot_int_clr	Fuel Gauge Over Temperature (OT) Interrupt Clear 0 = no-operation, 1 = self clears itself and corresponding bit [0] in Reg. 0Ah
1	fg_pack_commerr_int_clr	Fuel Gauge Pack Communications Error Interrupt Clear 0 = no-operation, 1 = self clears itself and corresponding bit [2] in Reg. 0Ah
2	fg_uv_int_clr	Fuel Gauge Under Voltage (UT) Interrupt Clear 0 = no-operation, 1 = self clears itself and corresponding bit [2] in Reg. 0Ah
3	fg_high_soc_clr	Fuel Gauge High SOC Interrupt Clear 0 = no-operation, 1 = self clears itself and corresponding bit [3] in Reg. 0Ah
4	fg_ut_int_clr	Fuel Gauge Under Temperature (UT) Interrupt Clear 0 = no-operation, 1 = self clears itself and corresponding bit [4] in Reg. 0Ah
5	fg_heartbeat_int_clr	Fuel Gauge Heart Beat Interrupt Clear 0 = no-operation, 1 = self clears itself and corresponding bit [5] in Reg. 0Ah
6	fg_limit_check_int_clr	Fuel Gauge Limit Check Interrupt Clear 0 = no-operation, 1 = self clears itself and corresponding bit [6] in Reg. 0Ah
7	fg_soc_zero_int_clr	Fuel Gauge Zero SOC Interrupt Clear 0 = no-operation, 1 = self clears itself and corresponding bit [7] in Reg. 0Ah
8	fg_soc_ltset_int_clr	Fuel Gauge SOC Low Threshold Set Interrupt Clear 0 = no-operation, 1 = self clears itself and corresponding bit [8] in Reg. 0Ah
9	fg_soc_ltclr_int_clr	Fuel Gauge SOC Low Threshold Clear Interrupt Clear 0 = no-operation, 1 = self clears itself and corresponding bit [9] in Reg. 0Ah
10	fg_active_int_clr	Fuel Gauge Active Interrupt Clear 0 = no-operation, 1 = self clears itself and corresponding bit [10] in Reg. 0Ah
11	fg_rdy_for_config_clr	Fuel Gauge Ready for Config Interrupt Clear 0 = no-operation, 1 = self clears itself and corresponding bit [11] in Reg. 0Ah
12	fg_wdt_int_clr	Fuel Gauge Watch Dog Timer Interrupt Clear 0 = no-operation, 1 = self clears itself and corresponding bit [12] in Reg. 0Ah
13	fg_i2cmstr_clr	I2C Master Interrupt Clear 0 = no-operation, 1 = self clears itself and corresponding bit [13] in Reg. 0Ah
14	fg_almost_full_int_clr	Fuel Gauge Software Interrupt Clears 0 = no-operation, 1 = self clears itself and corresponding bit [14] in Reg. 0Ah
15	fg_pack_voltage_int_clr	Fuel Gauge Pack Voltage Interrupt Clear 0 = no-operation, 1 = self clears itself and corresponding bit [15] in Reg. 0Ah

High SOC Alarm Threshold (FG_HIGH_SOC_THRESH)**Table 7. FG High SOC Alarm Threshold Register**

FG_HIGH_SOC_THRESH (0x59)						DataType = Short (unsigned)		
Bit Location	15	14	13	12	11	10	9	8
Parameter	fg_high_soc_thresh[15:8]							
Driver Default	0x00							
Type	R/W							
FG_HIGH_SOC_THRESH (0x59)						Units = %		
Bit Location	7	6	5	4	3	2	1	0
Parameter	fg_high_soc_thresh[7:0]							
Driver Default	0x5A							
Type	R/W							

Note:

20. Driver Default: 90 (90%).

Battery Temperature Alarm Level Maximum (FG_BATTERY_TEMP_MAX)**Table 8. FG Battery Temperature Alarm Threshold Maximum Register**

FG_BATTERY_TEMP_MAX (0x5A)						DataType = Short (unsigned)		
Bit Location	15	14	13	12	11	10	9	8
Parameter	fg_battery_temp_max[15:8]							
Driver Default	0x02							
Type	R/W							
FG_BATTERY_TEMP_MAX (0x5A)						Units = 0.1°C		
Bit Location	7	6	5	4	3	2	1	0
Parameter	fg_battery_temp_max[7:0]							
Driver Default	0x26							
Type	R/W							

Note:

21. Driver Default: 55°C.

Battery Temperature Alarm Level Minimum (FG_BATTERY_TEMP_MIN)**Table 9. FG Battery Temperature Alarm Threshold Maximum Register**

FG_BATTERY_TEMP_MIN (0x5B)						DataType = Short (unsigned)		
Bit Location	15	14	13	12	11	10	9	8
Parameter	fg_battery_temp_min[15:8]							
Driver Default	0x00							
Type	R/W							
FG_BATTERY_TEMP_MIN (0x5B)						Units = 0.1°C		
Bit Location	7	6	5	4	3	2	1	0
Parameter	fg_battery_temp_min[7:0]							
Driver Default	0x00							
Type	R/W							

Note:

22. Driver Default: 0°C.

Low State-of-Charge Alarm Threshold (FG_LOW_SOC_THRESH)**Table 10. FG Battery Temperature Alarm Threshold Maximum Register**

FG_LOW_SOC_THRESH (0x5C)						DataType = Short (unsigned)		
Bit Location	15	14	13	12	11	10	9	8
Parameter	fg_low_soc_thresh[15:8]							
Driver Default	0x00							
Type	R/W							
FG_LOW_SOC_THRESH (0x5C)						Units = %		
Bit Location	7	6	5	4	3	2	1	0
Parameter	fg_low_soc_thresh[7:0]							
Driver Default	0x0A							
Type	R/W							

Note:

23. Driver Default: 10%.

Run Time Input Registers

Implementation Overview

The FFG1040 has been optimized for system side fuel gauging applications internal to mobile phone or tablet. It can be used with both embedded and removable single-cell battery packs. That is the application example shown below. Additionally the fuel gauge can be used internal to a battery pack.

Internal to system the FFG1040 is connected to an Applications Processor that uses embedded firmware to control and access the device via I²C. The Applications Processor contains the I²C Master that uses read and write transactions to initiate commands and read from

and write data to the device. The FFG1040 contains an I²C slave used to respond to these commands and data requests.

Figure 12 below shows the FFG1040 and the external components used to support its connection to the host and to the battery pack. The recommended values for the external components are shown below in Table 11. The recommended value for battery decoupling capacitance is dependent on the system and charger and is not defined below.

Typical Application

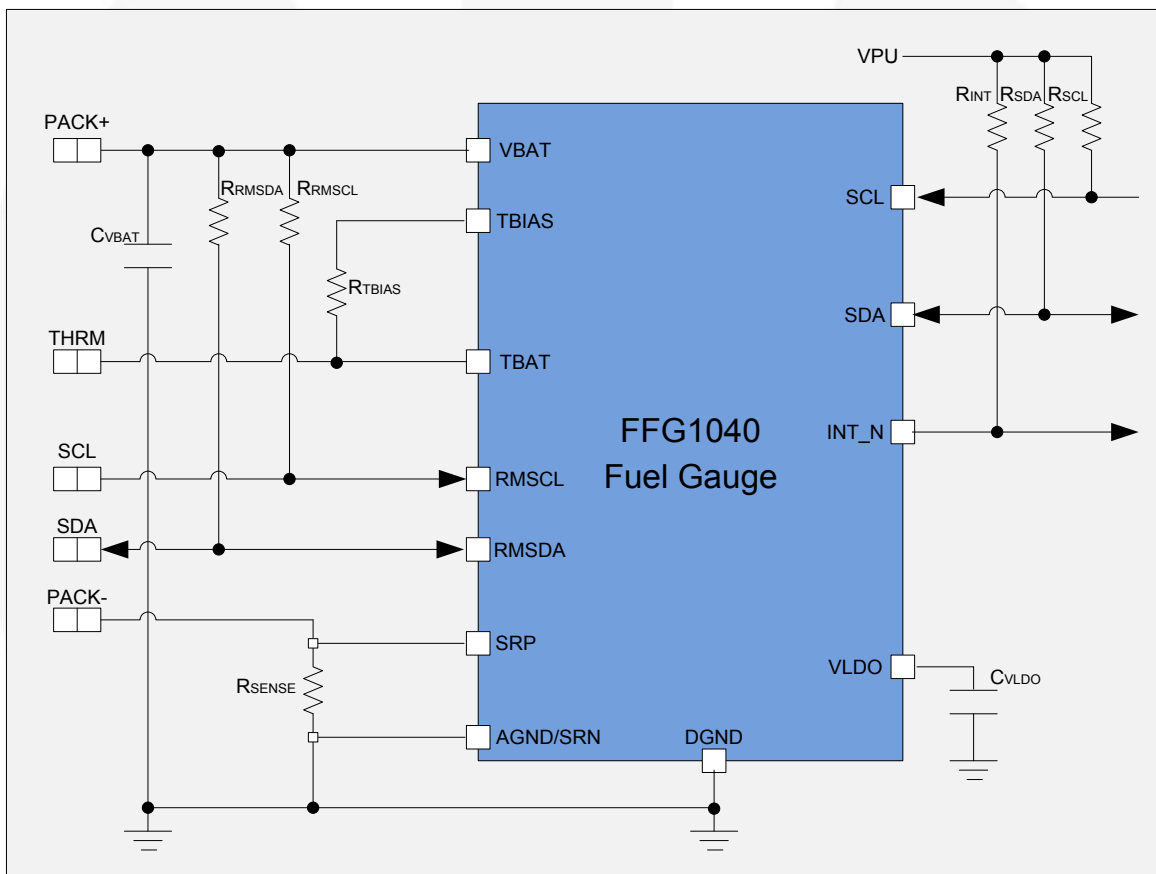

Figure 12. Simplified Schematic

Table 11. Recommended External Components

Component	Description	Typical	Unit
CVBAT	CVBAT Decoupling Capacitor	100 ±10%	nF
CVLDO	VLDO Compensation Capacitor	100 ±10%	nF
RSENSE	External Sense Resistor between SRP and AGND	5 ±1%	mΩ
RTBIAS	Battery Thermistor Bias Resistance	10 ±1%	kΩ
RSDA, RSCL, RMSDA, RMSCL, RINT	I ² C Pull up Resistor to VPU (SDA, SCL, INT_N)	10 ±10%	kΩ

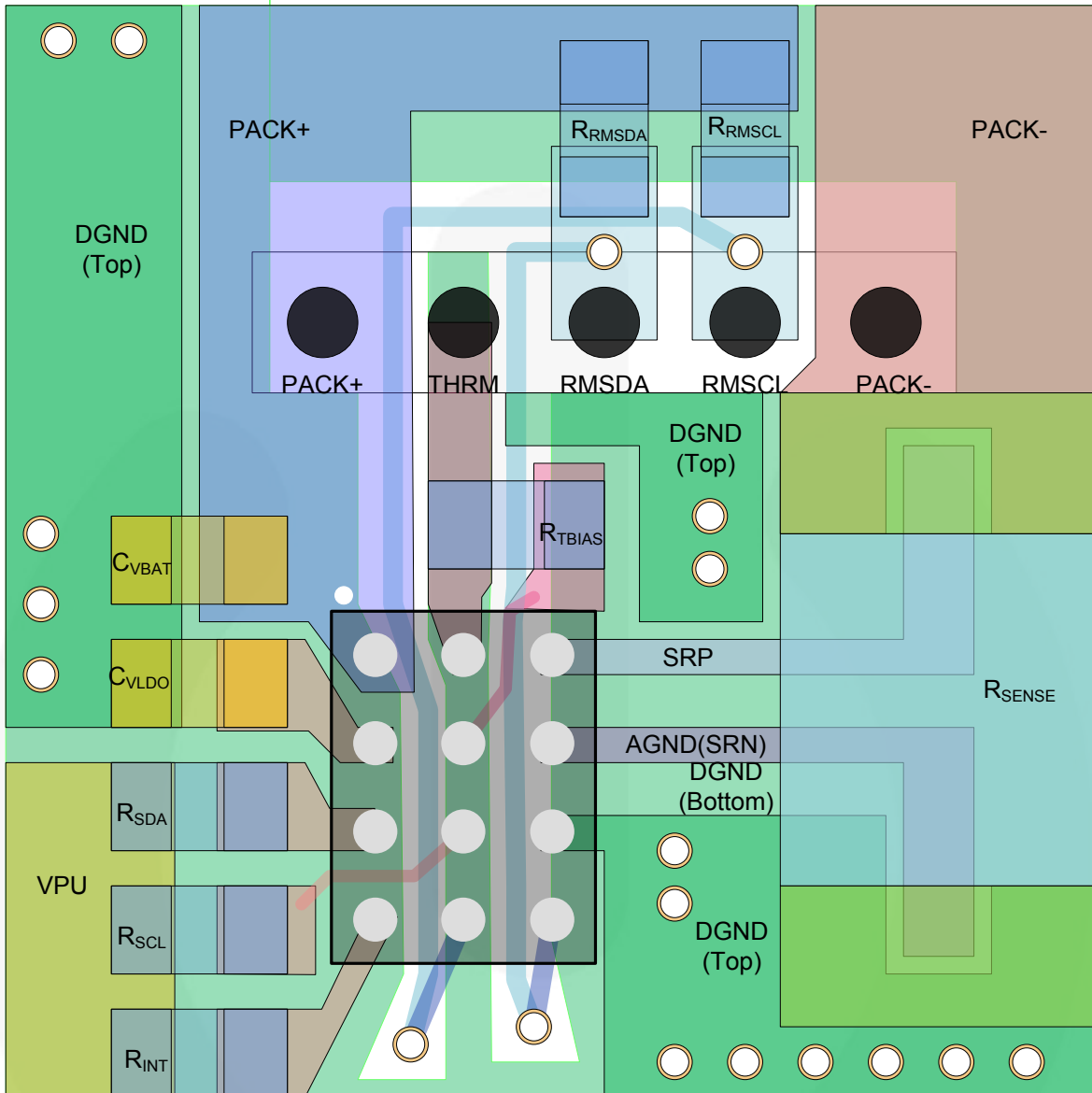
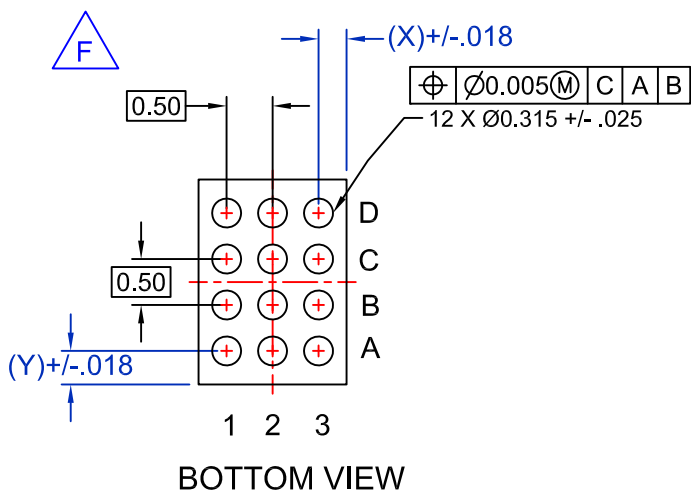
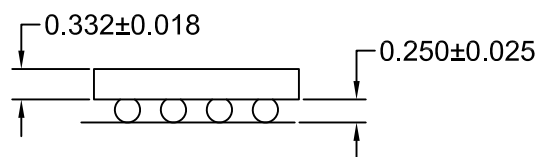
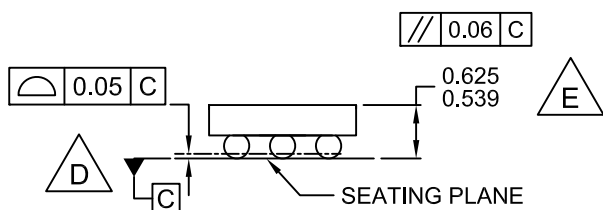
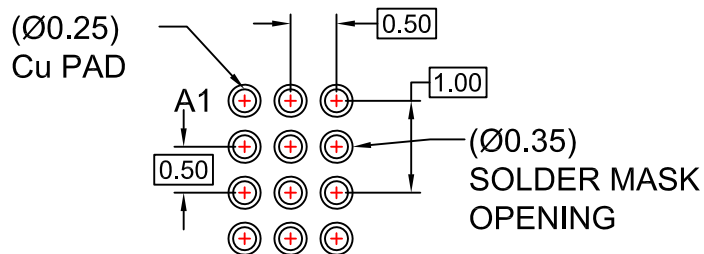
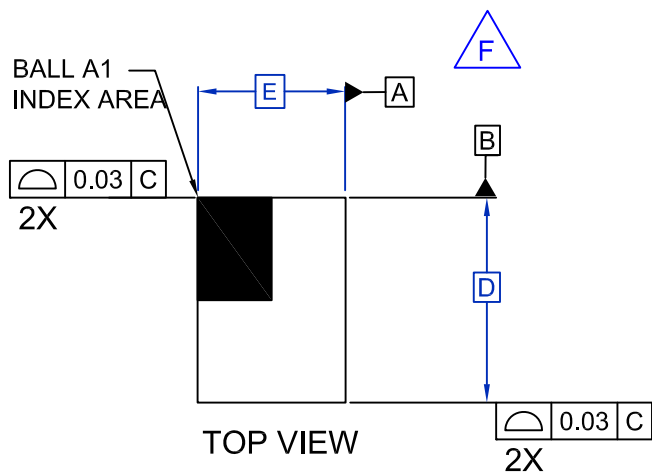

Figure 13. Recommended Layout

The table below pertains to the packaging information on the following page.

Package Specific Dimensions

D (mm)	E (mm)	X (mm)	Y (mm)
1.960	1.510	0.255	0.230



NOTES:

- A. NO JEDEC REGISTRATION APPLIES.
- B. DIMENSIONS ARE IN MILLIMETERS.
- C. DIMENSIONS AND TOLERANCES PER ASME Y14.5M, 1994.
- D. DATUM C, THE SEATING PLANE, IS DEFINED BY THE SPHERICAL CROWNS OF THE BALLS.
- E. PACKAGE TYPICAL HEIGHT IS 582 MICRONS ± 38 MICRONS (539-625 MICRONS).
- F. FOR DIMENSIONS D, E, X, AND Y SEE PRODUCT DATASHEET.
- G. DRAWING FILENAME: MKT-UC012AArev2

ON Semiconductor and  are trademarks of Semiconductor Components Industries, LLC dba ON Semiconductor or its subsidiaries in the United States and/or other countries. ON Semiconductor owns the rights to a number of patents, trademarks, copyrights, trade secrets, and other intellectual property. A listing of ON Semiconductor's product/patent coverage may be accessed at www.onsemi.com/site/pdf/Patent-Marking.pdf. ON Semiconductor reserves the right to make changes without further notice to any products herein. ON Semiconductor makes no warranty, representation or guarantee regarding the suitability of its products for any particular purpose, nor does ON Semiconductor assume any liability arising out of the application or use of any product or circuit, and specifically disclaims any and all liability, including without limitation special, consequential or incidental damages. Buyer is responsible for its products and applications using ON Semiconductor products, including compliance with all laws, regulations and safety requirements or standards, regardless of any support or applications information provided by ON Semiconductor. "Typical" parameters which may be provided in ON Semiconductor data sheets and/or specifications can and do vary in different applications and actual performance may vary over time. All operating parameters, including "Typicals" must be validated for each customer application by customer's technical experts. ON Semiconductor does not convey any license under its patent rights nor the rights of others. ON Semiconductor products are not designed, intended, or authorized for use as a critical component in life support systems or any FDA Class 3 medical devices or medical devices with a same or similar classification in a foreign jurisdiction or any devices intended for implantation in the human body. Should Buyer purchase or use ON Semiconductor products for any such unintended or unauthorized application, Buyer shall indemnify and hold ON Semiconductor and its officers, employees, subsidiaries, affiliates, and distributors harmless against all claims, costs, damages, and expenses, and reasonable attorney fees arising out of, directly or indirectly, any claim of personal injury or death associated with such unintended or unauthorized use, even if such claim alleges that ON Semiconductor was negligent regarding the design or manufacture of the part. ON Semiconductor is an Equal Opportunity/Affirmative Action Employer. This literature is subject to all applicable copyright laws and is not for resale in any manner.

PUBLICATION ORDERING INFORMATION

LITERATURE FULFILLMENT:

Literature Distribution Center for ON Semiconductor
19521 E. 32nd Pkwy, Aurora, Colorado 80011 USA
Phone: 303-675-2175 or 800-344-3860 Toll Free USA/Canada
Fax: 303-675-2176 or 800-344-3867 Toll Free USA/Canada
Email: orderlit@onsemi.com

N. American Technical Support: 800-282-9855 Toll Free
USA/Canada
Europe, Middle East and Africa Technical Support:
Phone: 421 33 790 2910
Japan Customer Focus Center
Phone: 81-3-5817-1050

ON Semiconductor Website: www.onsemi.com
Order Literature: <http://www.onsemi.com/orderlit>
For additional information, please contact your local
Sales Representative

Mouser Electronics

Authorized Distributor

Click to View Pricing, Inventory, Delivery & Lifecycle Information:

[onsemi:](#)

[FFG1040UC003X](#)