

## ANT-5GW-IPW2-NP Outdoor Cellular Sub-6 5G Antenna

The ANT-5GW-IPW2-NP is an outdoor IP67-rated multiband dipole antenna for 5G New Radio, LTE, and cellular IoT (LTE-M, NB-IoT) applications.

The ANT-5GW-IPW2-NP provides a ground plane independent dipole antenna solution which mounts to metallic and non-metallic surfaces. The ANT-5GW-IPW2-NP housing is UV stabilized fiberglass and the antenna connects using an N plug (male pin) connector.



### Features

- Performance at 3300 MHz to 3800 MHz
  - VSWR:  $\leq 1.9$
  - Peak Gain: 0.5 dBi
  - Efficiency: 36%
- Performance at 2496 MHz to 2690 MHz
  - VSWR:  $\leq 1.7$
  - Peak Gain: 1.5 dBi
  - Efficiency: 40%
- Enhanced heat and chemical resistant UV stabilized fiberglass antenna housing material
- IP67 rated
- N plug (male pin) connector

### Applications

- Worldwide 5G/4G/3G/2G
- Cellular IoT: LTE-M (Cat-M1) and NB-IoT
- Private cellular networks
  - Citizens Broadband Radio Service (CBRS)
- 4.9 GHz Public Safety
- Emerging 5G C-Band applications
- Emerging 5G 2.5 GHz EBS applications

### Ordering Information

Part Number	Description
ANT-5GW-IPW2-NP	Outdoor cellular 5G antenna with N plug (male pin) connector

Available from Linx Technologies and select distributors and representatives.

Table 1. Electrical Specifications

Bands	Frequency Range	VSWR (max.)	Peak Gain (dBi)	Avg. Gain (dBi)	Efficiency (%)
71	617 MHz to 698 MHz	8.1	1.0	-2.8	54
12, 13, 14, 17, 26, 28, 29	698 MHz to 803 MHz	8.5	1.5	-2.7	56
5, 8, 20	791 MHz to 960 MHz	3.9	1.6	-2.7	56
1, 2, 3, 4, 25, 66	1710 MHz to 2200 MHz	2.4	1.2	-4.0	41
30, 40	2300 MHz to 2400 MHz	1.8	1.6	-4.0	40
7, 41	2496 MHz to 2690 MHz	1.7	1.5	-4.0	40
22, 42, 43, 48, 49, 52, n77, n78	3300 MHz to 3800 MHz	1.9	0.5	-7.5	36
CBRS	3550 MHz to 3700 MHz	1.6	2.4	-1.3	77
C-Band	3700 MHz to 4200 MHz	1.8	2.4	-2.0	68
n79	4400 MHz to 5000 MHz	2.7	3.7	-3.0	54
Impedance	50 Ω				
Polarization	Linear				
Radiation	Omnidirectional				
Wavelength	1/2-wave				
Electrical Type	Dipole				
Max Power	2 W				

Electrical specifications and plots measured with the antenna in a free space orientation.

Table 2. Mechanical Specifications

Parameter	Value
Connection	N plug (male pin)
Connector Torque Recommended/Maximum	5 Nm/ 15 Nm
Operating Temperature Range	-30 °C to +70 °C
Ingress Protection Rating (IP)	IP67 rated
Antenna Color	White
Weight	94.2 g (3.32 oz)
Dimensions	132.0 mm x Ø24.0 mm (5.20 in x Ø0.98 in)

Product Dimensions

Figure 1 provides dimensions of the ANT-5GW-IPW2-NP antenna.

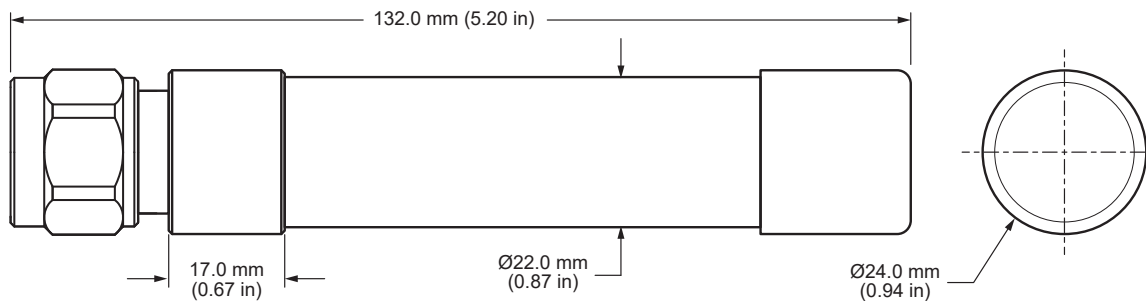

Figure 1. ANT-5GW-IPW2-NP Antenna Dimensions

**Packaging Information**

The ANT-5GW-IPW2-NP antenna is packaged in a clear plastic bag. Distribution channels may offer alternative packaging options.

**IP (Ingress Protection) Rating**

An ingress protection rating (IP rating) refers to the capability of a device to withstand the ingress of dust and/or water under specified conditions. IP rating is typically reserved for marketable product (device) rather than constituent components because design and assembly may affect performance of the device under testing. IP-rated antennas are designed to support the specified level of ingress protection and may be tested in a standalone configuration, however IP testing should be performed on the complete end product to ensure desired performance.

**Antenna Orientation**

The ANT-5GW-IPW2-NP antenna is characterized in two antenna orientations as shown in Figure 2. The antenna free space orientation characterizes use of an antenna attached to an enclosure-mounted connector which is connected by cable to a printed circuit board. Although the antenna is a dipole not requiring a ground plane for function, characterization with an adjacent ground plane (102 mm x 102 mm) provides insight into antenna performance when attached directly to a connector on a metal enclosure. The two orientations represent the most common end-product use cases.

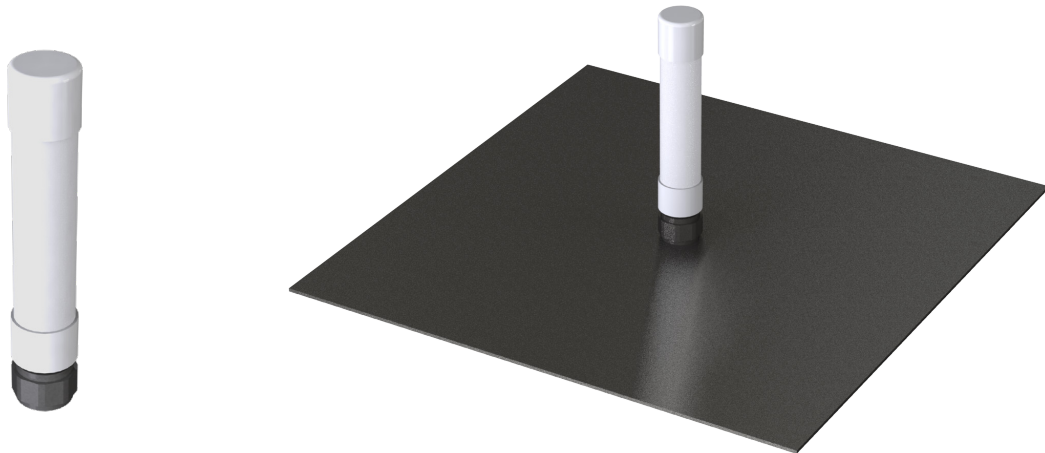

ANT-5GW-IPW2-NP in Free Space

ANT-5GW-IPW2-NP at Center of 300 mm x 300 mm Ground Plane

**Figure 2. ANT-5GW-IPW2-NP Test Orientations**

Free Space, No Ground Plane

The charts on the following pages represent data taken with the antenna oriented in free space as shown in Figure 3.



Figure 3. ANT-5GW-IPW2-NP No Ground Plane (Free Space)

VSWR

Figure 4 provides the voltage standing wave ratio (VSWR) across the antenna bandwidth. VSWR describes the power reflected from the antenna back to the radio. A lower VSWR value indicates better antenna performance at a given frequency. Reflected power is also shown on the right-side vertical axis as a gauge of the percentage of transmitter power reflected back from the antenna.

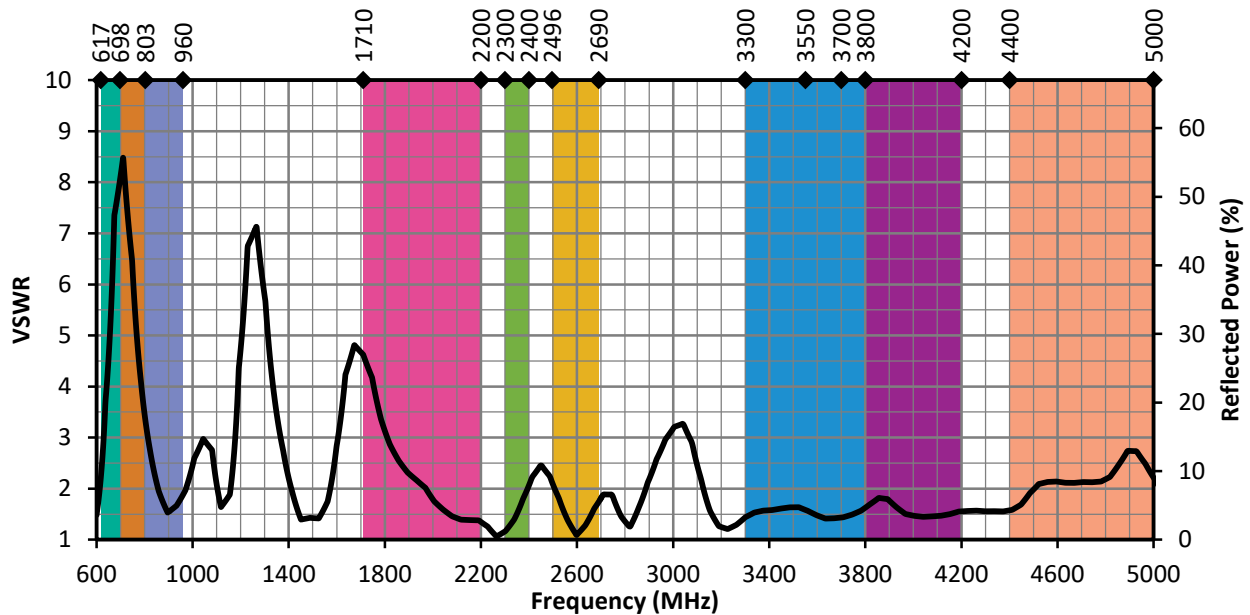

Figure 4. ANT-5GW-IPW2-NP VSWR, Free Space

Return Loss

Return loss (Figure 5), represents the loss in power at the antenna due to reflected signals. Like VSWR, a lower return loss value indicates better antenna performance at a given frequency.

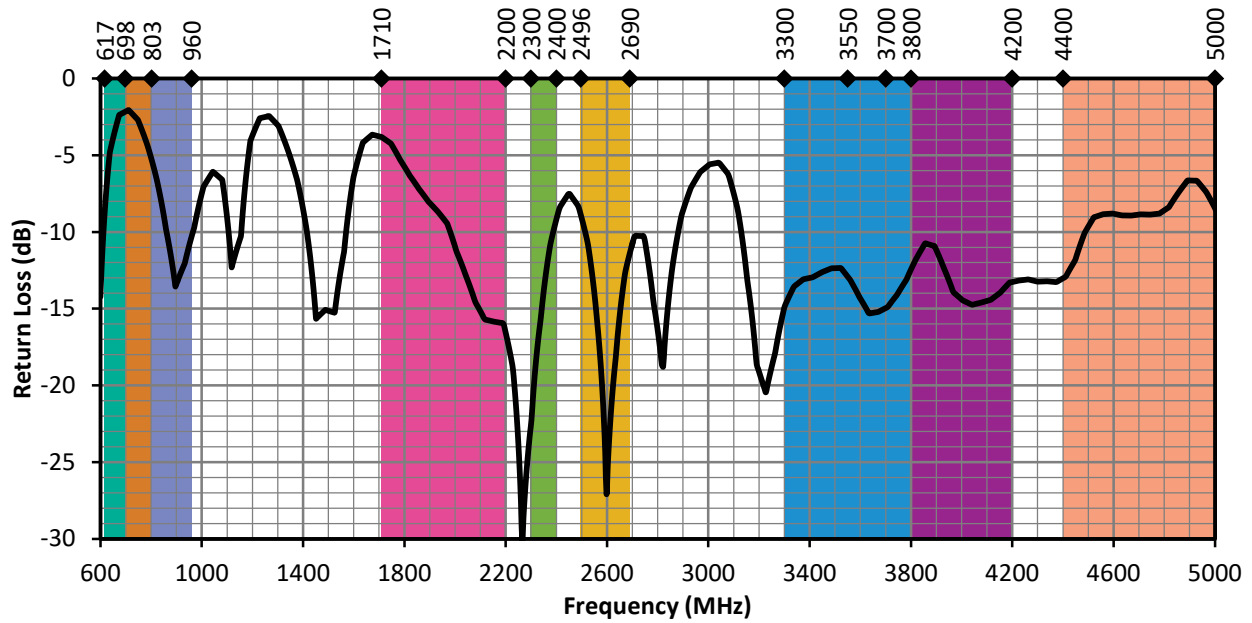

Figure 5. ANT-5GW-IPW2-NP Return Loss, Free Space

Peak Gain

The peak gain across the antenna bandwidth is shown in Figure 6. Peak gain represents the maximum antenna input power concentration across 3-dimensional space, and therefore peak performance at a given frequency, but does not consider any directionality in the gain pattern.

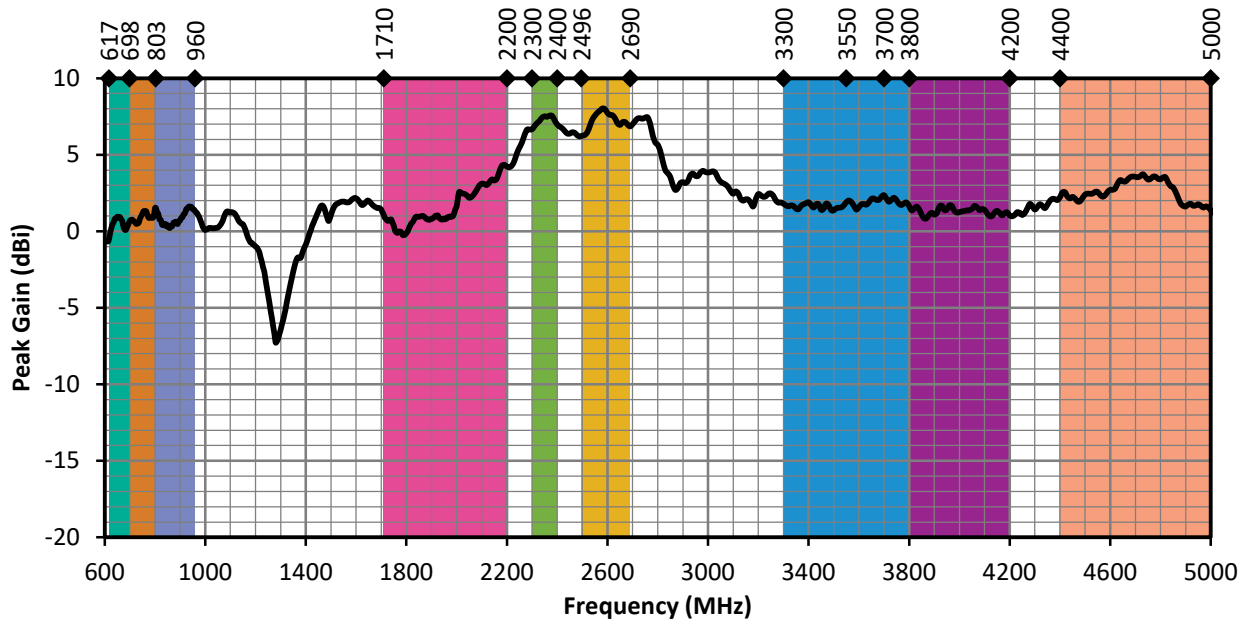

Figure 6. ANT-5GW-IPW2-NP Peak Gain, Free Space

Average Gain

Average gain (Figure 7), is the average of all antenna gain in 3-dimensional space at each frequency, providing an indication of overall performance without expressing antenna directionality.

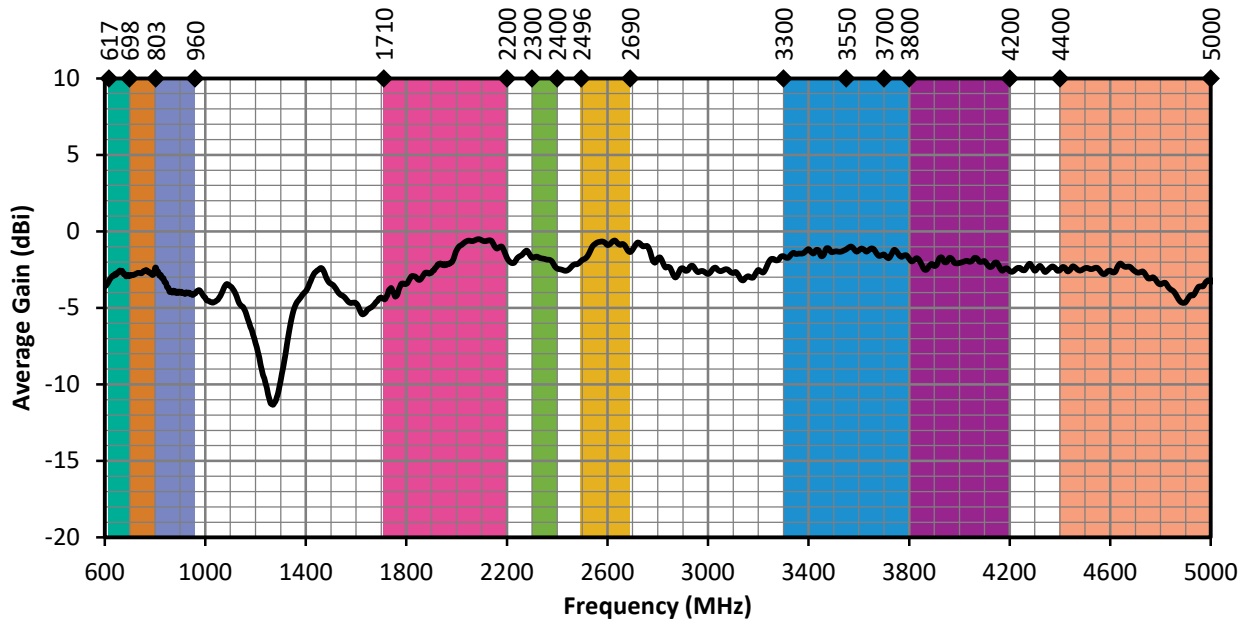

Figure 7. ANT-5GW-IPW2-NP Antenna Average Gain, Free Space

Radiation Efficiency

Radiation efficiency (Figure 8), shows the ratio of power delivered to the antenna relative to the power radiated at the antenna, expressed as a percentage, where a higher percentage indicates better performance at a given frequency.

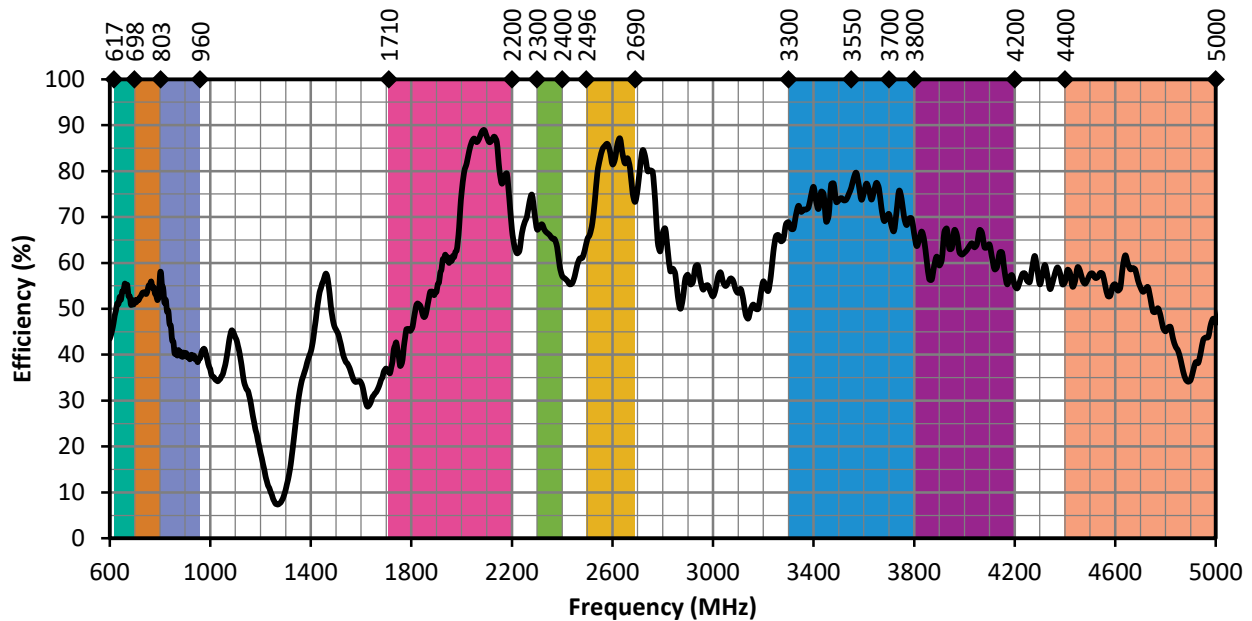

Figure 8. ANT-5GW-IPW2-NP Antenna Efficiency, Free Space

Radiation Patterns

Radiation patterns provide information about the directionality and 3-dimensional gain performance of the antenna by plotting gain at specific frequencies in three orthogonal planes. Antenna radiation patterns for a free space orientation are shown in Figure 9 using polar plots covering 360 degrees. The antenna graphic at the top of the page provides reference to the plane of the column of plots below it. Note: when viewed with typical PDF viewing software, zooming into radiation patterns is possible to reveal fine detail.

Radiation Patterns - Free Space



XZ-Plane Gain



YZ-Plane Gain



XY-Plane Gain

617 MHz to 698 MHz (660 MHz)

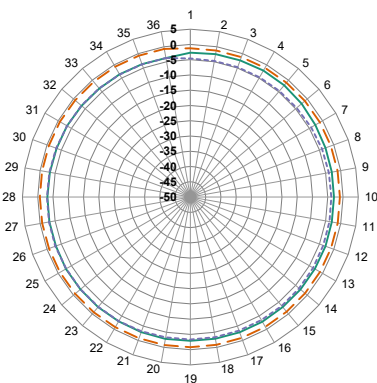

XZ-Plane Gain

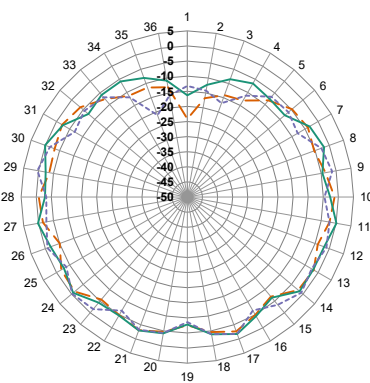

YZ-Plane Gain

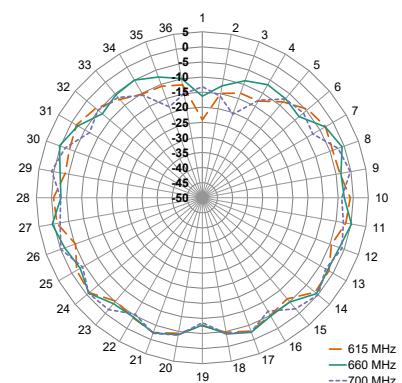

XY-Plane Gain

698 MHz to 803 MHz (750 MHz)

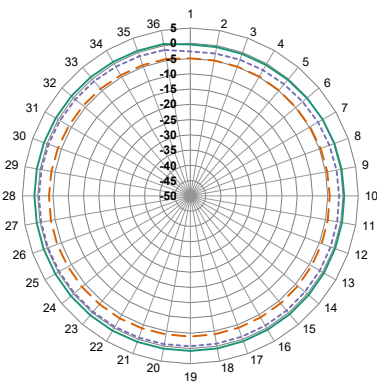

XZ-Plane Gain

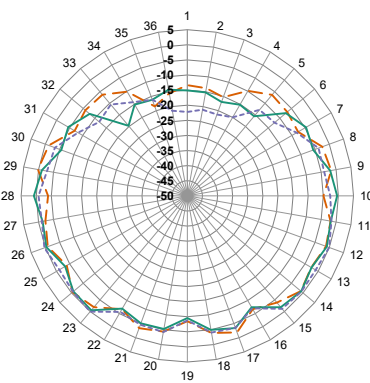

YZ-Plane Gain

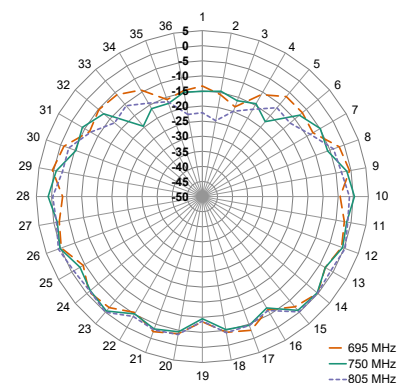

XY-Plane Gain

Radiation Patterns - Free Space

791 MHz to 960 MHz (870 MHz)

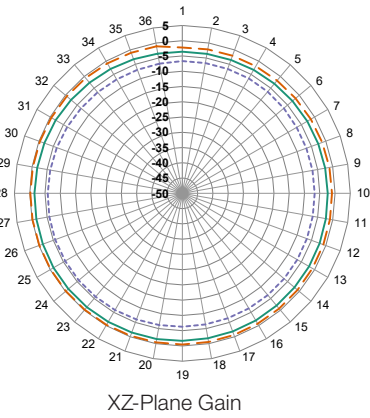

XZ-Plane Gain

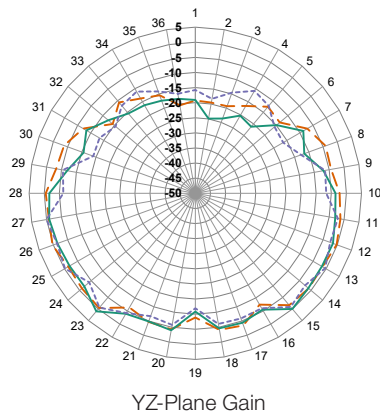

YZ-Plane Gain

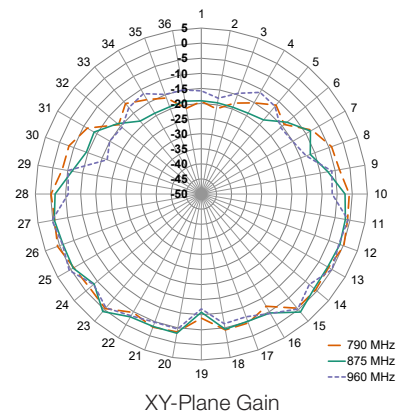

XY-Plane Gain

1710 MHz to 2200 MHz (1950 MHz)

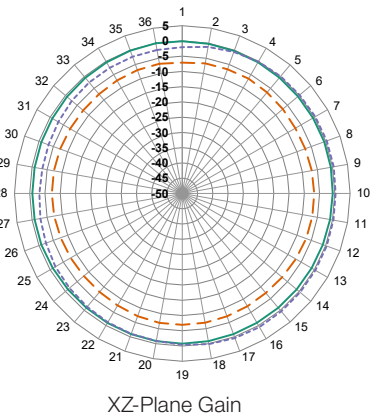

XZ-Plane Gain

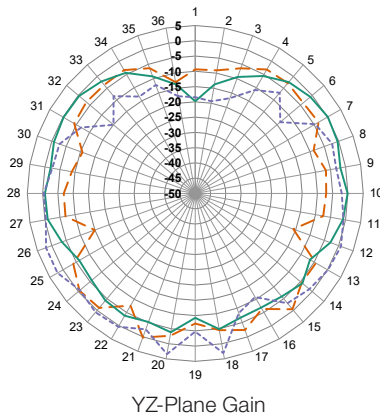

YZ-Plane Gain

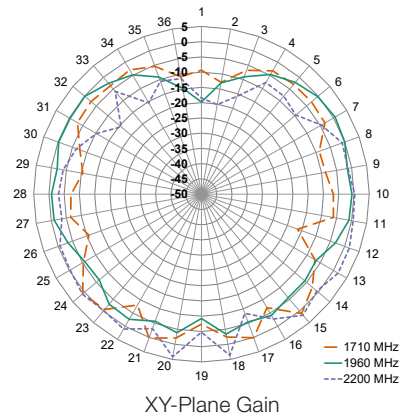

XY-Plane Gain

2300 MHz to 2400 MHz (2350 MHz)

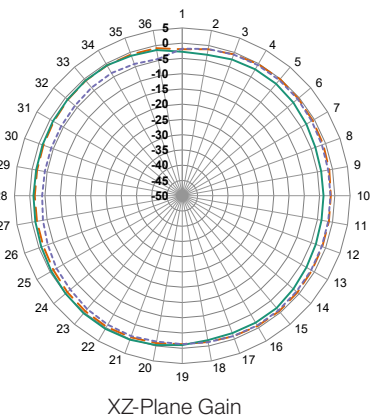

XZ-Plane Gain

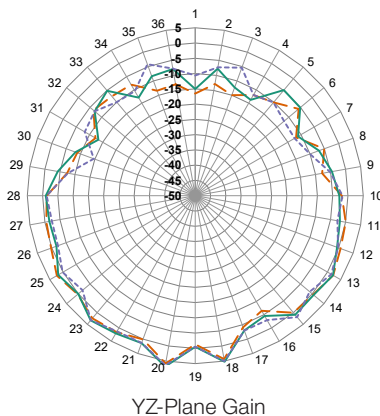

YZ-Plane Gain

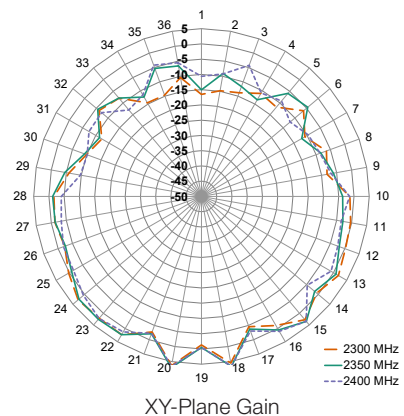

XY-Plane Gain



Radiation Patterns - Free Space

2496 MHz to 2690 MHz (2600 MHz)

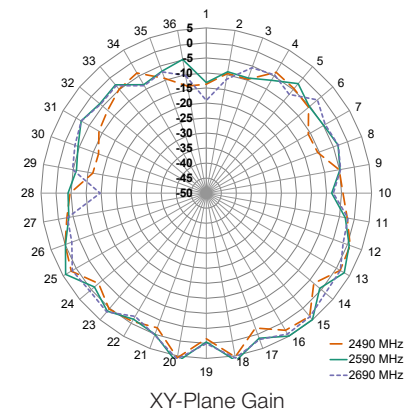
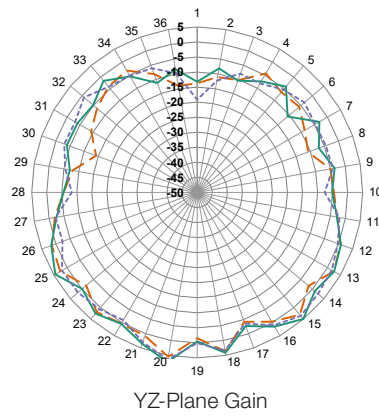
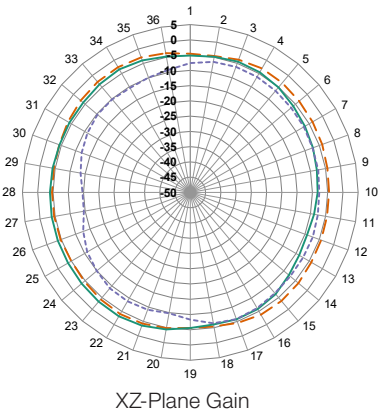

3300 MHz to 3800 MHz (3550 MHz)

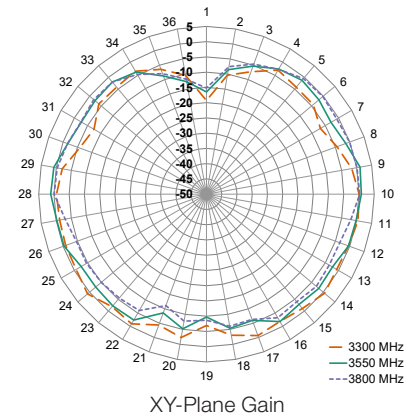
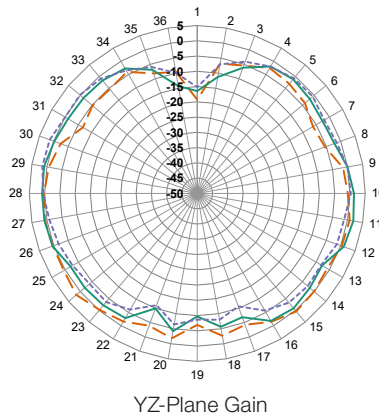
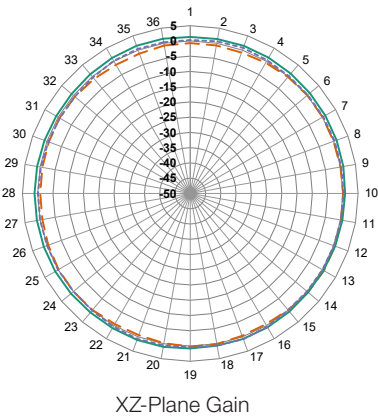

3550 MHz to 3700 MHz (3620 MHz)

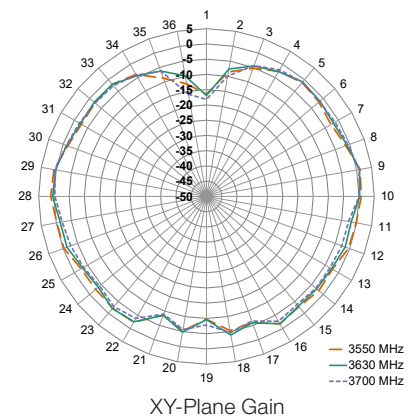
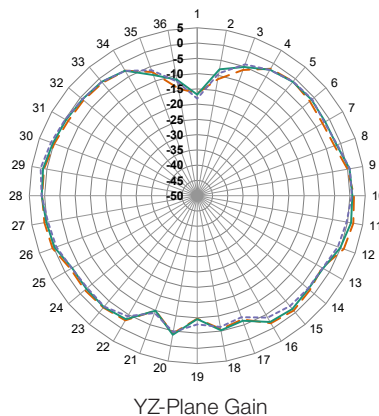
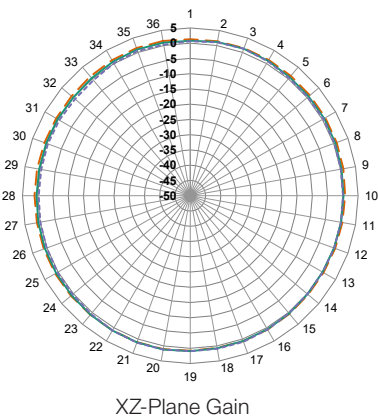

Radiation Patterns - Free Space  
3700 MHz to 4200 MHz (3950 MHz)

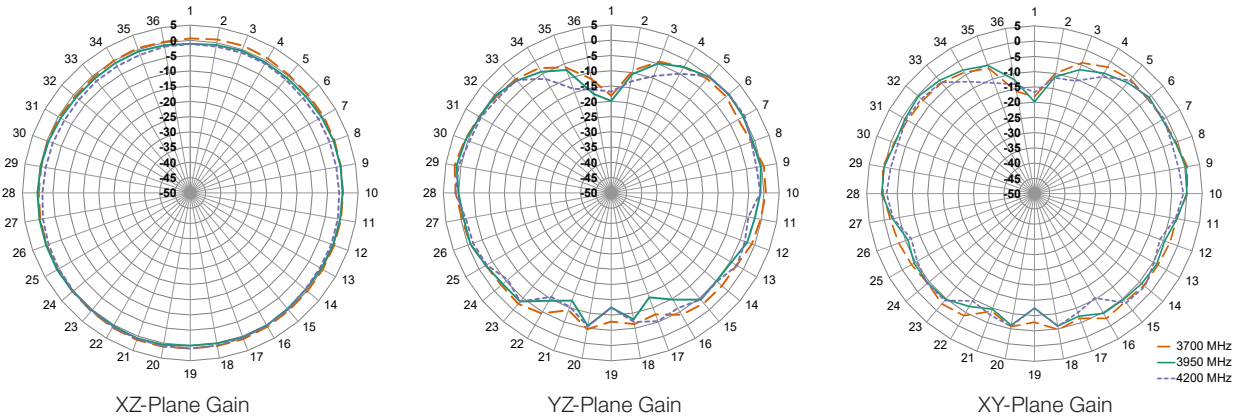

4400 MHz to 5000 MHz (4700 MHz)

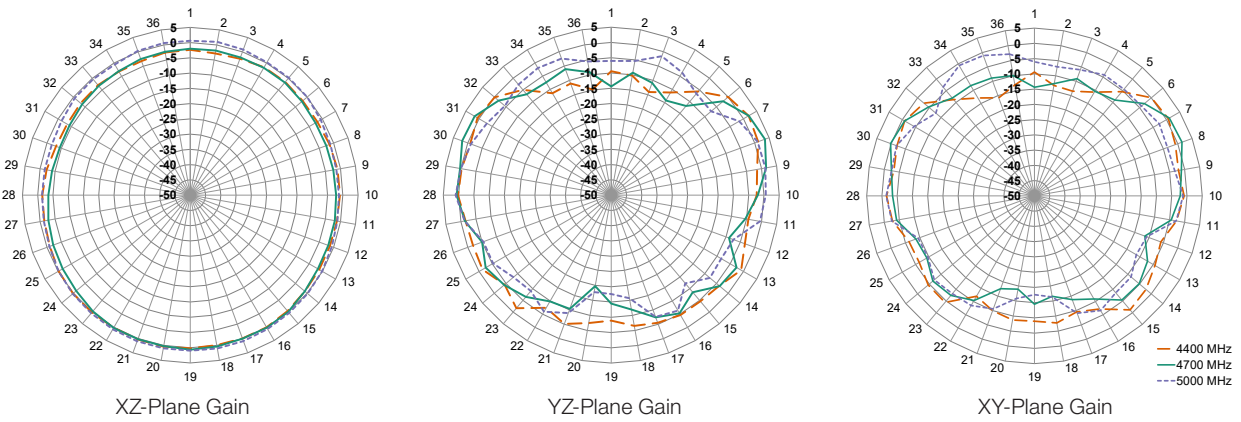

Figure 9. Radiation Patterns for ANT-5GW-IPW2-NP, Free Space

Center of Ground Plane

The charts on the following pages represent data taken with the antenna oriented at the center of the 300 mm x 300 mm ground plane as shown in Figure 10.

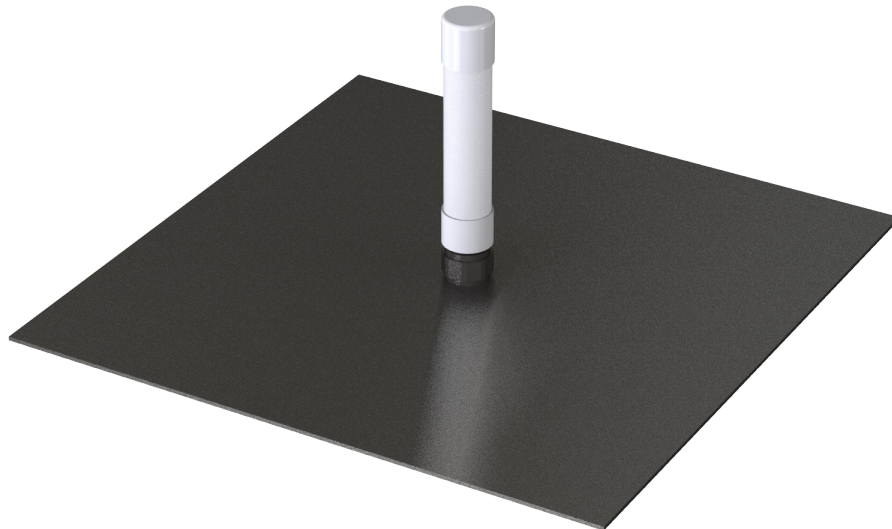

Figure 10. ANT-5GW-IPW2-NP at Center of Ground Plane

VSWR

Figure 11 provides the voltage standing wave ratio (VSWR) across the antenna bandwidth. VSWR describes the power reflected from the antenna back to the radio. A lower VSWR value indicates better antenna performance at a given frequency. Reflected power is also shown on the right-side vertical axis as a gauge of the percentage of transmitter power reflected back from the antenna.

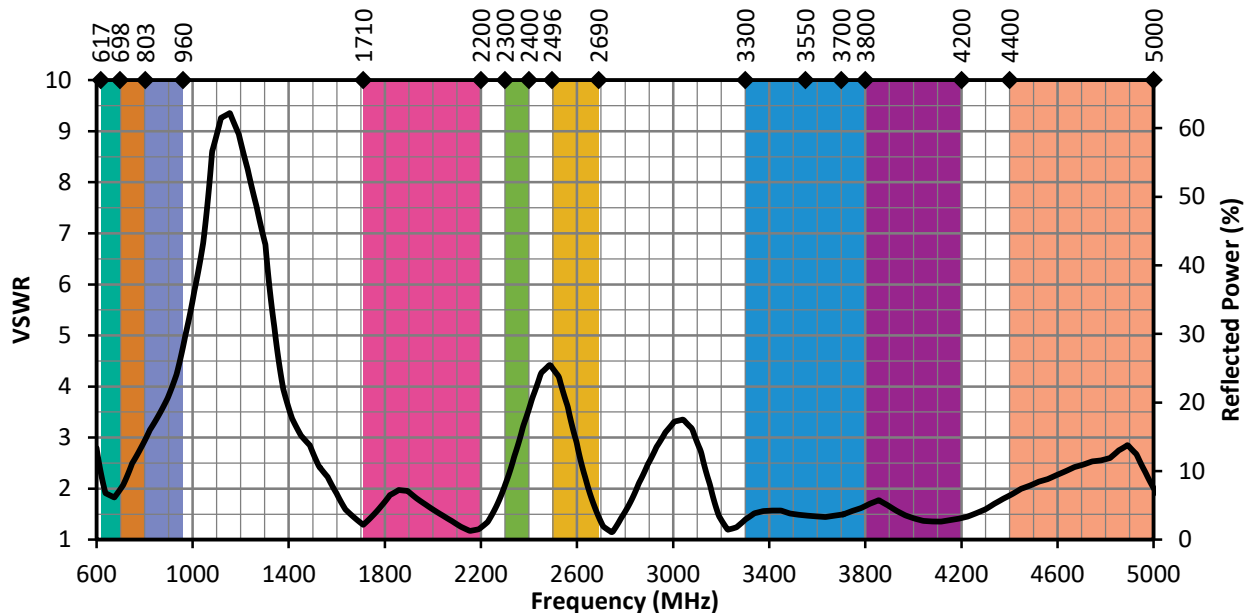

Figure 11. ANT-5GW-IPW2-NP VSWR, Center of Ground Plane

Return Loss

Return loss (Figure 12), represents the loss in power at the antenna due to reflected signals. Like VSWR, a lower return loss value indicates better antenna performance at a given frequency.

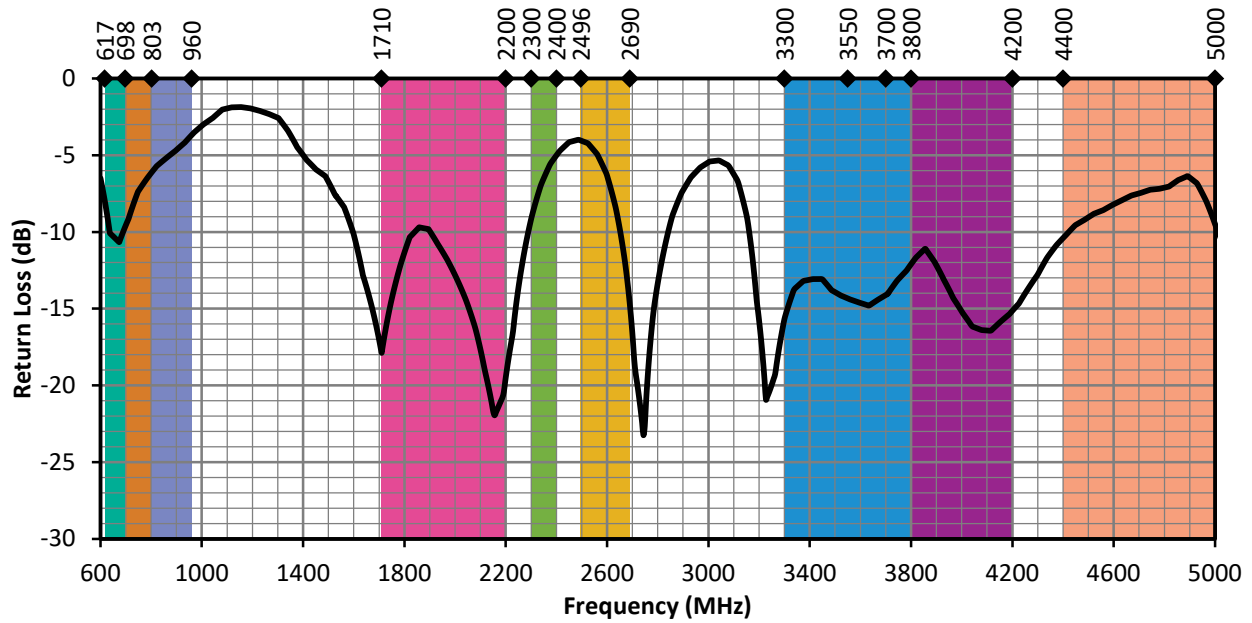

Figure 12. ANT-5GW-IPW2-NP Return Loss, Center of Ground Plane

Peak Gain

The peak gain across the antenna bandwidth is shown in Figure 13. Peak gain represents the maximum antenna input power concentration across 3-dimensional space, and therefore peak performance at a given frequency, but does not consider any directionality in the gain pattern.

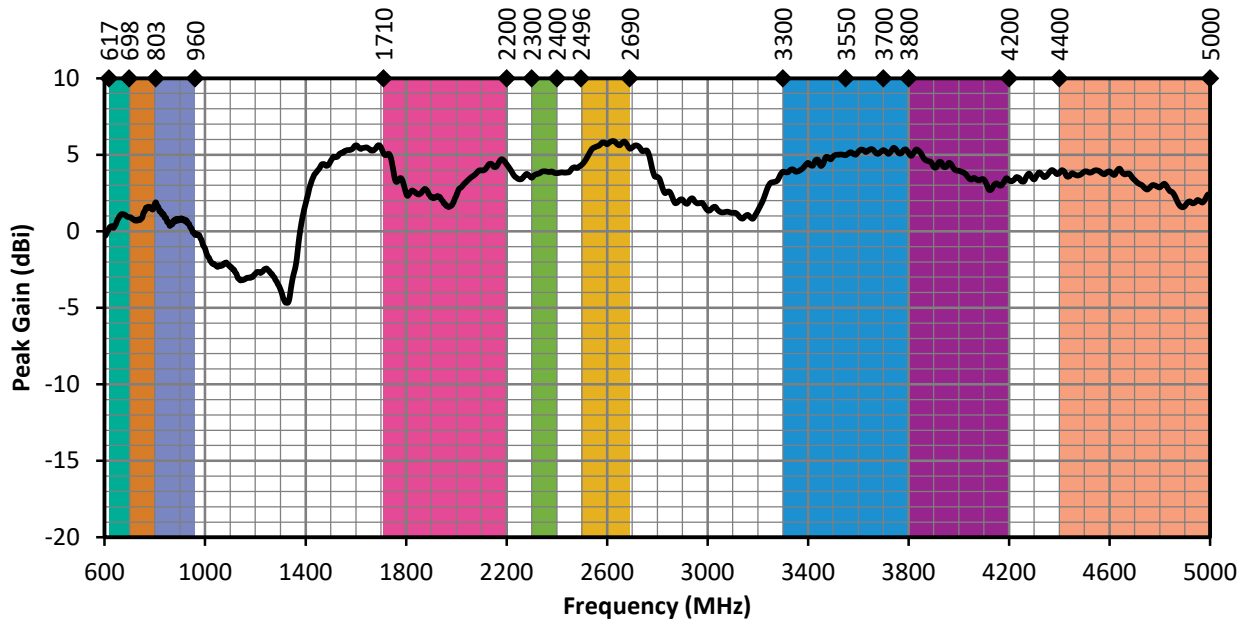

Figure 13. ANT-5GW-IPW2-NP Peak Gain, Center of Ground Plane

### Average Gain

Average gain (Figure 14), is the average of all antenna gain in 3-dimensional space at each frequency, providing an indication of overall performance without expressing antenna directionality.

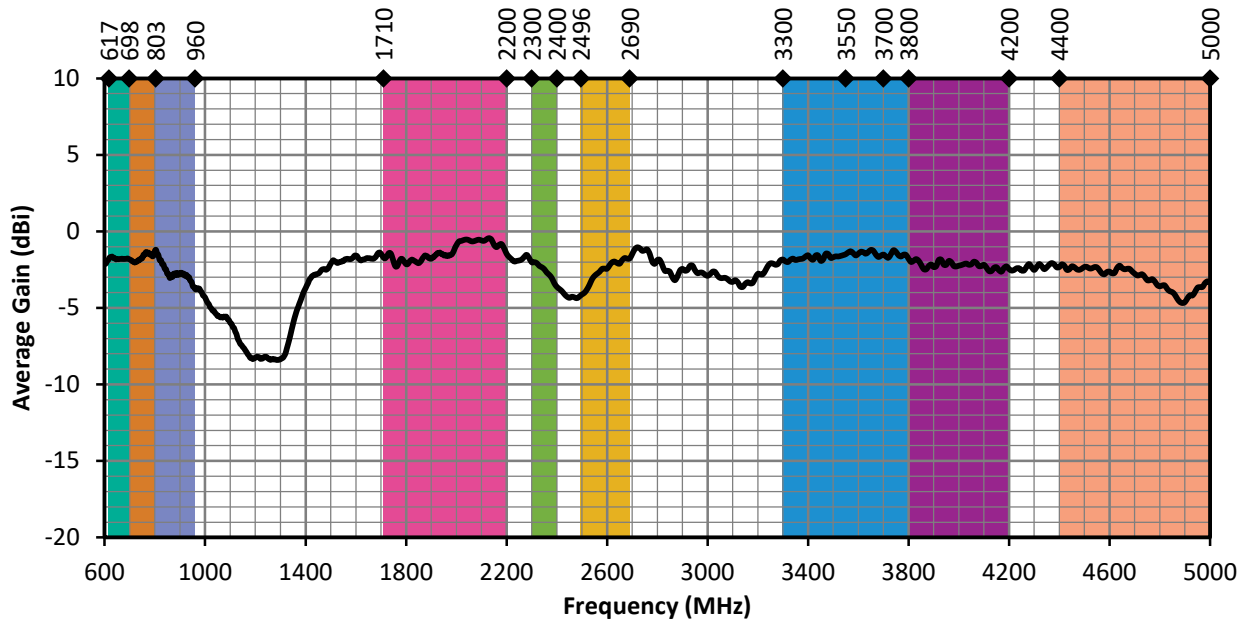

Figure 14. ANT-5GW-IPW2-NP Antenna Average Gain, Center of Ground Plane

### Radiation Efficiency

Radiation efficiency (Figure 15), shows the ratio of power delivered to the antenna relative to the power radiated at the antenna, expressed as a percentage, where a higher percentage indicates better performance at a given frequency.

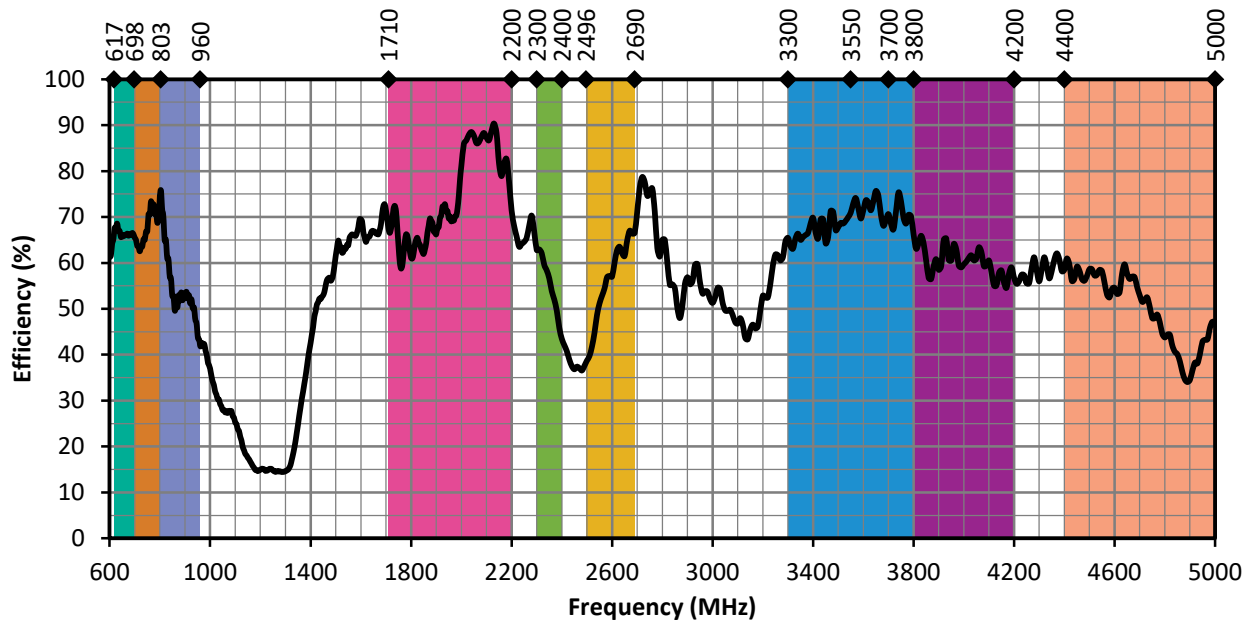
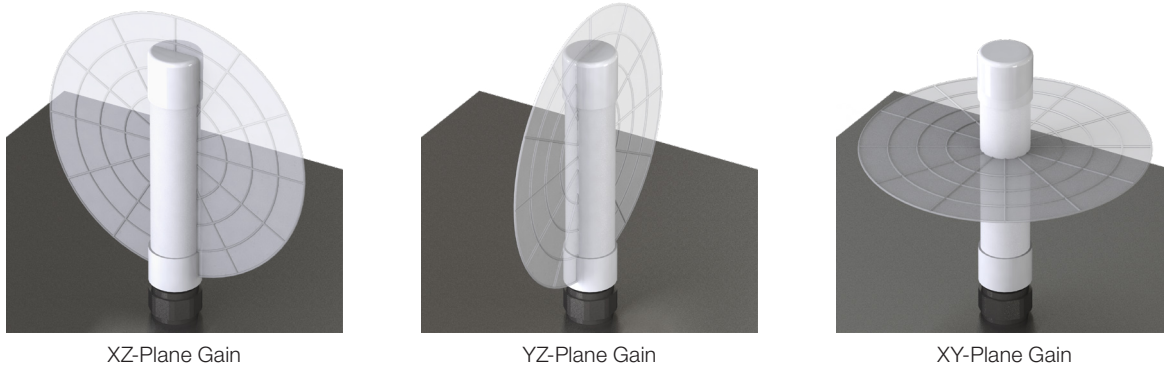

Figure 15. ANT-5GW-IPW2-NP Antenna Efficiency, Center of Ground Plane

### Radiation Patterns

Radiation patterns provide information about the directionality and 3-dimensional gain performance of the antenna by plotting gain at specific frequencies in three orthogonal planes. Antenna radiation patterns for an orientation at the center of the ground plane are shown in Figure 16 using polar plots covering 360 degrees. The antenna graphic at the top of the page provides reference to the plane of the column of plots below it. Note: when viewed with typical PDF viewing software, zooming into radiation patterns is possible to reveal fine detail.

### Radiation Patterns - Center of Ground Plane



### 617 MHz to 698 MHz (660 MHz)

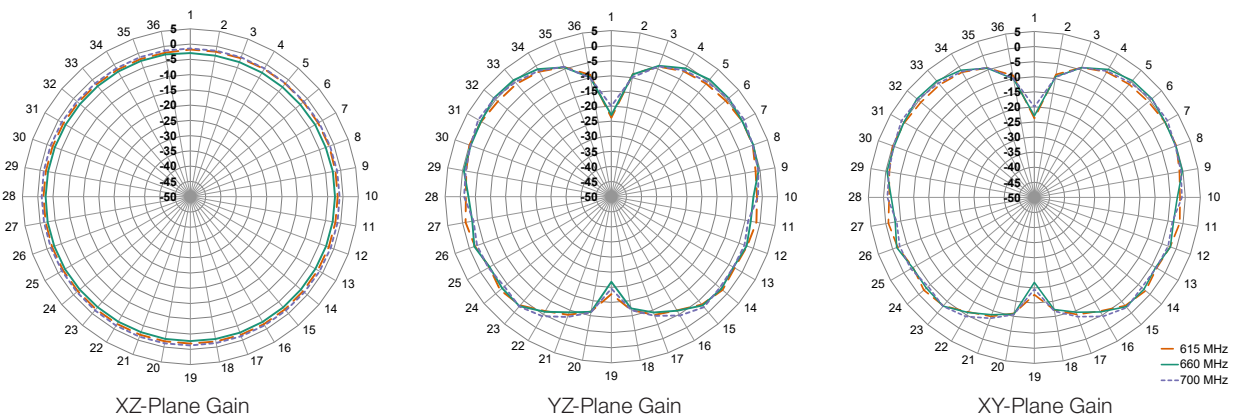

### 698 MHz to 803 MHz (750 MHz)

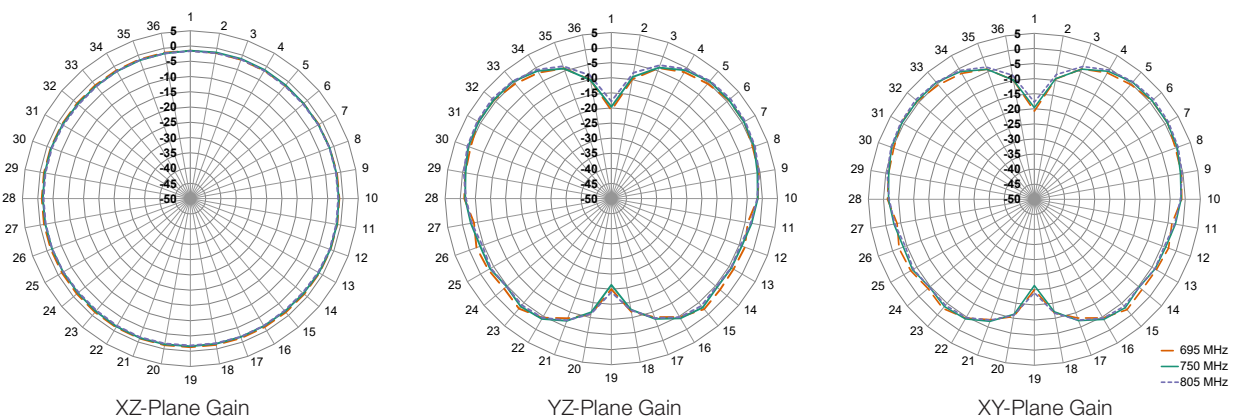

Radiation Patterns - Center of Ground Plane

791 MHz to 960 MHz (870 MHz)

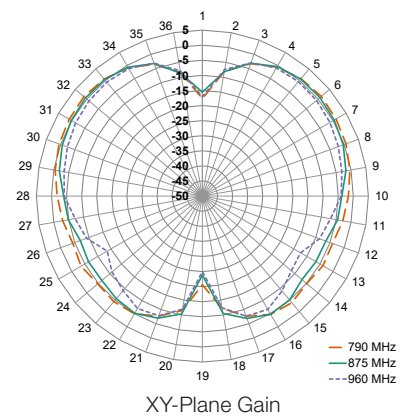
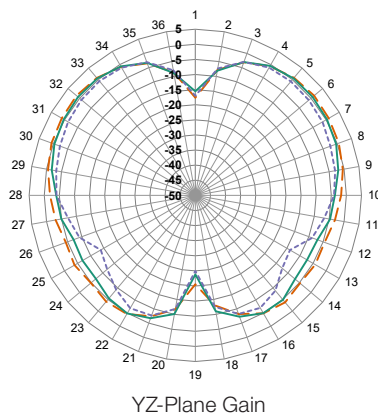
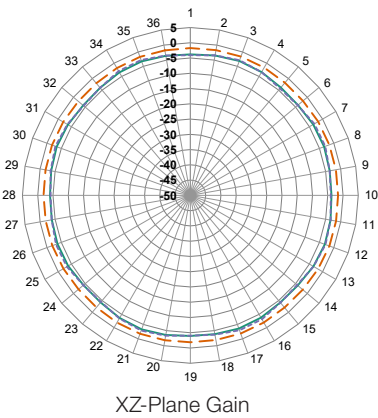

— 790 MHz  
— 875 MHz  
- - 960 MHz

1710 MHz to 2200 MHz (1950 MHz)

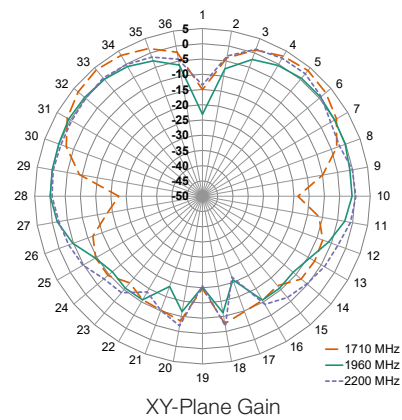
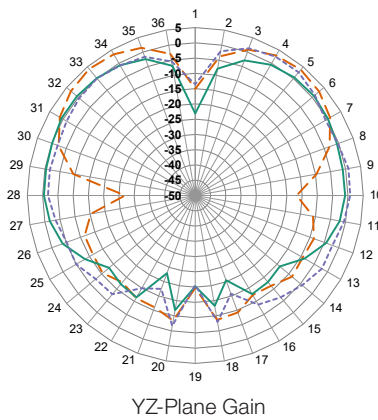
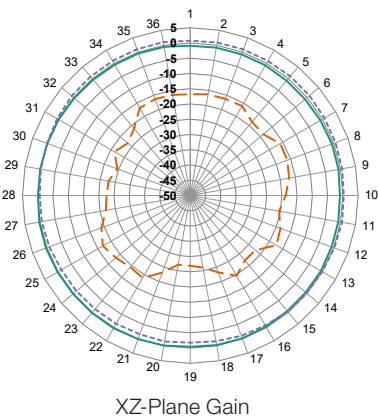

— 1710 MHz  
— 1960 MHz  
- - 2200 MHz

2300 MHz to 2400 MHz (2350 MHz)

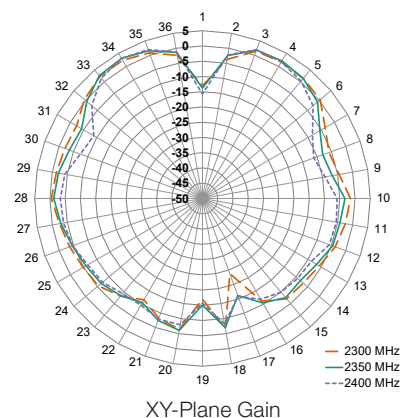
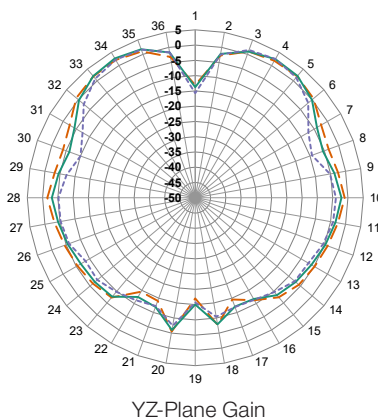
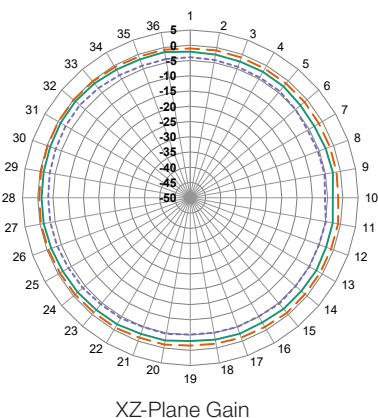

— 2300 MHz  
— 2350 MHz  
- - 2400 MHz

Radiation Patterns - Center of Ground Plane  
2496 MHz to 2690 MHz (3620 MHz)

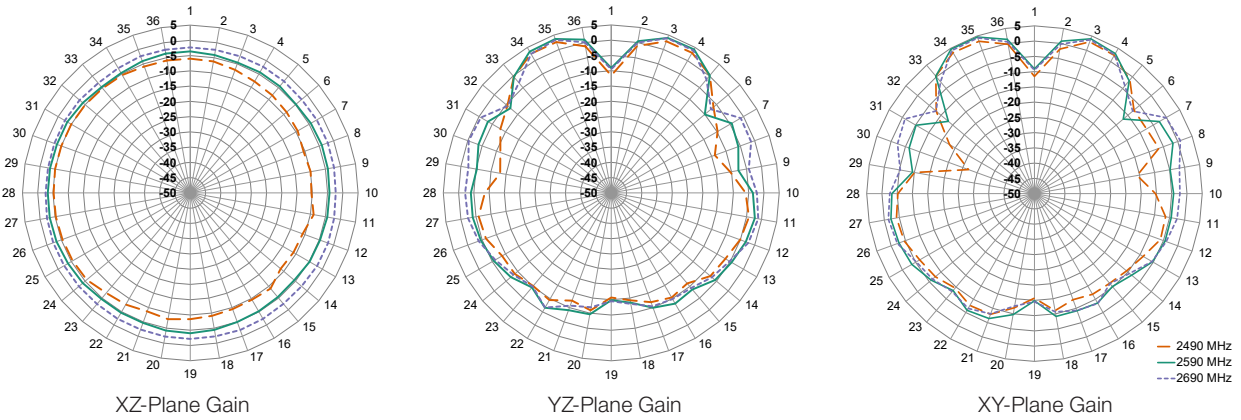

3300 MHz to 3800 MHz (3550 MHz)

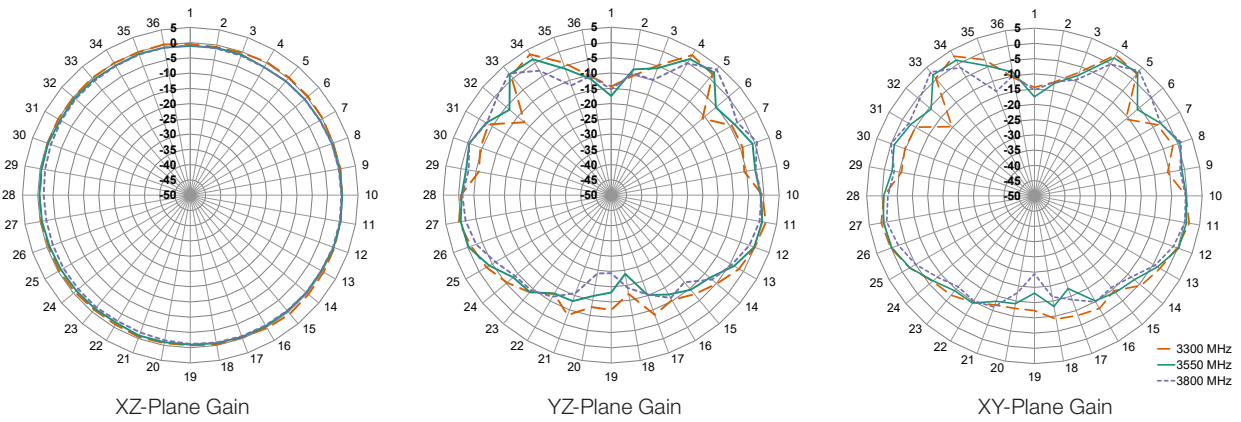

3550 MHz to 3700 MHz (3620 MHz)

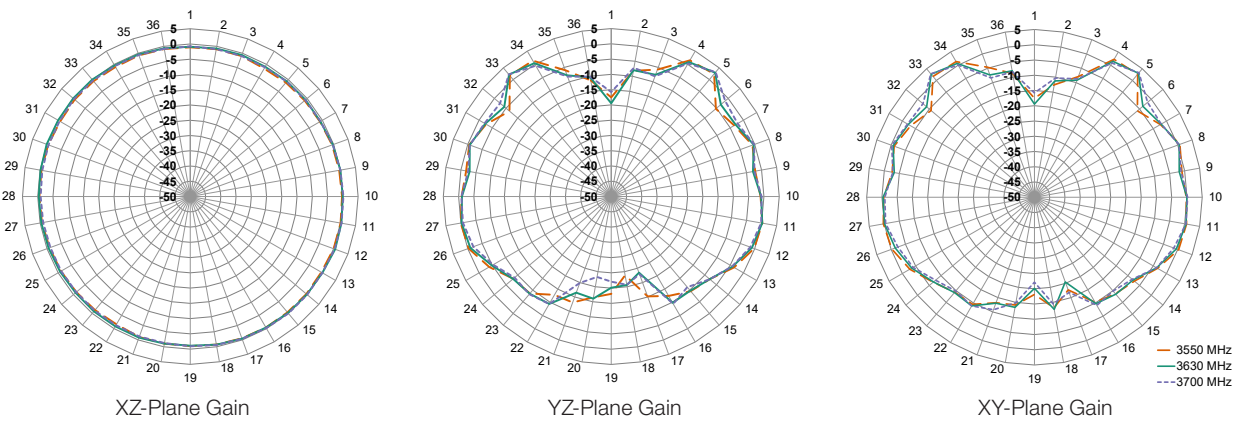



Radiation Patterns - Center of Ground Plane  
3700 MHz to 4200 MHz (3950 MHz)

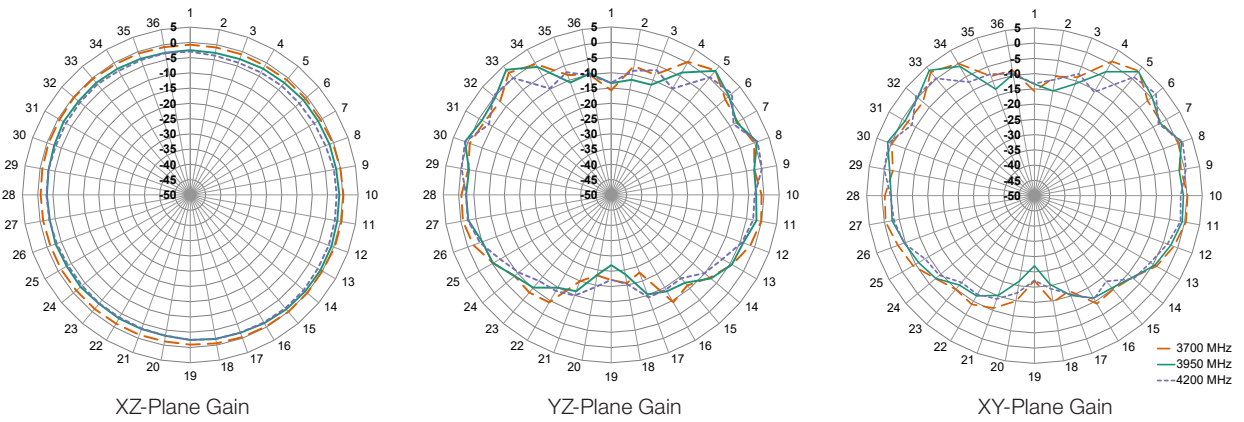

4400 MHz to 5000 MHz (4700 MHz)

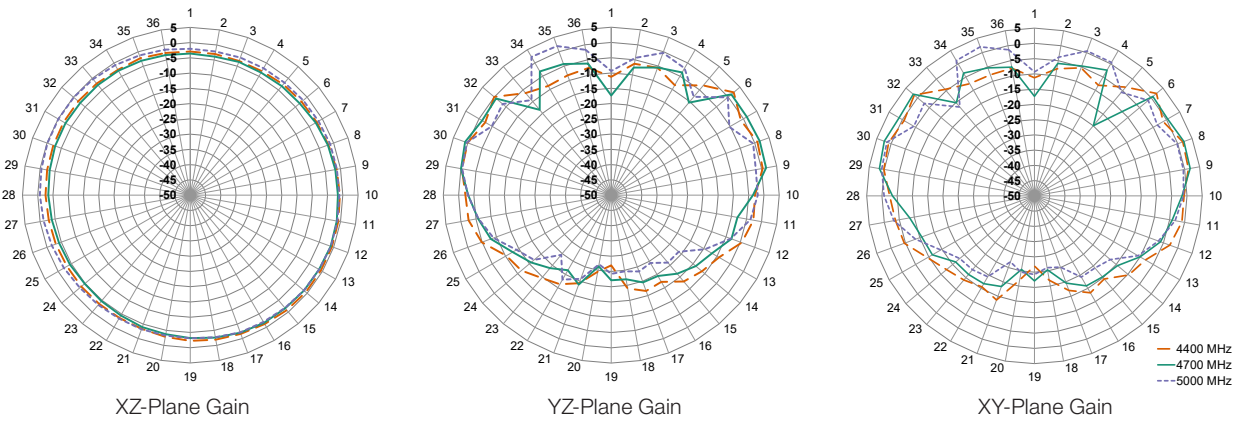

Figure 16. Radiation Patterns for ANT-5GW-IPW2-NP, Center of Ground Plane

---

**Website:** <http://linxtechnologies.com>  
**Linx Offices:** 159 Ort Lane, Merlin, OR, US 97532  
**Phone:** +1 (541) 471-6256  
**E-MAIL:** [info@linxtechnologies.com](mailto:info@linxtechnologies.com)

---

Linx Technologies reserves the right to make changes to the product(s) or information contained herein without notice. No liability is assumed as a result of their use or application. No rights under any patent accompany the sale of any such product(s) or information.

Wireless Made Simple is a registered trademark of Linx Acquisitions LLC. Other product and brand names may be trademarks or registered trademarks of their respective owners.

Copyright © 2021 Linx Technologies

All Rights Reserved

Doc# DS21273-185ANT

