

Driver Transistors PNP Silicon

●FEATURES

- 1) We declare that the material of product compliant with RoHS requirements and Halogen Free.
- 2) S- Prefix for Automotive and Other Applications Requiring Unique Site and Control Change Requirements; AEC-Q101 Qualified and PPAP Capable.

●DEVICE MARKING AND ORDERING INFORMATION

Device	Marking	Shipping
LMBTA56LT1G	2GM	3000/Tape&Reel
LMBTA56LT3G	2GM	10000/Tape&Reel

●MAXIMUM RATINGS(Ta = 25°C)

Parameter	Symbol	Limits	Unit
Collector–Emitter Voltage	V _{CEO}	-80	Vdc
Collector–Base Voltage	V _{CBO}	-80	Vdc
Emitter–Base Voltage	V _{EBO}	-4.0	Vdc
Collector Current — Continuous	I _c	-500	mAdc

●THERMAL CHARACTERISTICS

Parameter	Symbol	Limits	Unit
Total Power Dissipation FR-5 Board,(Note 1.)@Ta = 25°C	PD	225	mW
Derate above 25°C		1.8	°C/W
Thermal Resistance – Junction-to-Ambient	R _{θJA}	556	°C/W
Total Power Dissipation Alumina Substrate,(Note 2.)@Ta = 25°C	PD	300	mW
Derate above 25°C		2.4	°C/W
Thermal Resistance, Junction-to-Ambient	R _{θJA}	417	°C/W
Junction and Storage Temperature Range	T _J , T _{stg}	-55 to +150	°C

1. FR-5 = 1.0 x 0.75 x 0.062 in.

2. Alumina = 0.4 x 0.3 x 0.024 in. 99.5% alumina.

LMBTA56LT1G S-LMBTA56LT1G

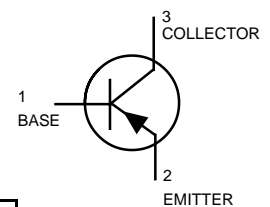
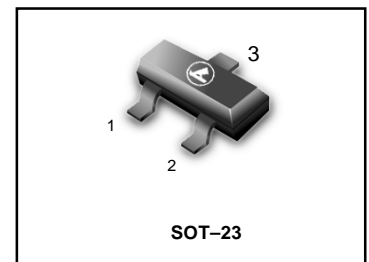

LMBTA56LT1G,S-LMBTA56LT1G

● ELECTRICAL CHARACTERISTICS (Ta= 25°C)

Characteristic	Symbol	Min.	Typ.	Max.	Unit
Collector–Emitter Breakdown Voltage(Note 3) (I _C = - 1 mA _{dc} , I _B = 0)	V _{BR(CEO)}	-80	–	–	V
Emitter–Base Breakdown Voltage (I _E = -100 μA _{dc} , I _C = 0)	V _{BR(EBO)}	-4	–	–	V
Collector Cutoff Current (V _{CE} = - 60 V _{dc} , I _E = 0)	I _{CES}	–	–	-0.1	μA
Collector Cutoff Current (V _{CB} = - 80 V _{dc} , I _E = 0)	I _{CBO}	–	–	-0.1	μA
DC Current Gain (I _C = -10 mA _{dc} , V _{CE} = -1 V _{dc}) (I _C = -100 mA _{dc} , V _{CE} = -1 V _{dc})	h _{FE}	100 100	– –	– –	
Collector–Emitter Saturation Voltage (I _C = -100mA _{dc} , I _B = -10 mA _{dc})	V _{CE(sat)}	–	–	-0.25	V
Base–Emitter On Voltage (I _C = -100mA _{dc} , V _{CE} = -1 mA _{dc})	V _{BE(on)}	–	–	-1.20	V
Current–Gain — Bandwidth Product(Note 4.) (I _C = -100mA _{dc} , V _{CE} = -1V _{dc} , f = 100MHz)	f _T	50	–	–	MHz

3. Pulse Test: Pulse Width ≅ 300 μs, Duty Cycle ≅ 2.0%.

4. f_T is defined as the frequency at which |h_{fe}| extrapolates to unity.

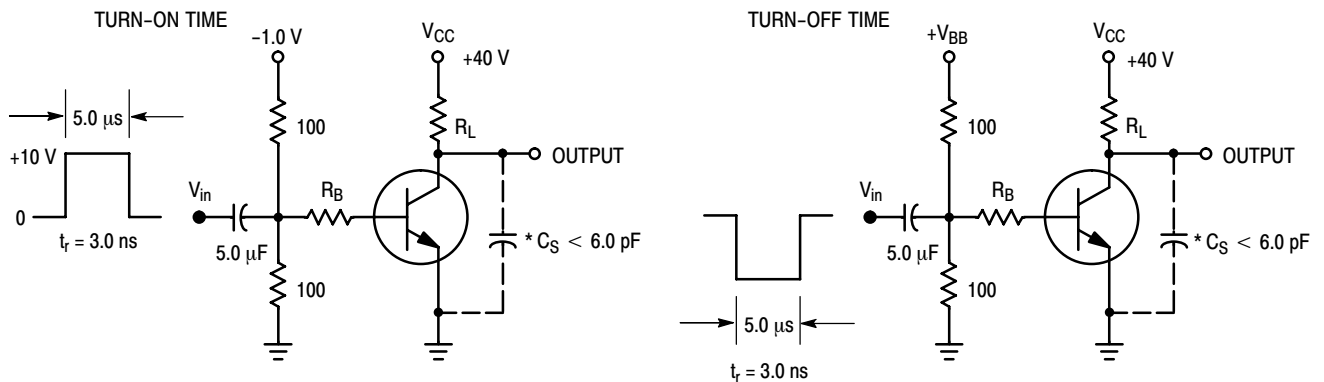

*Total Shunt Capacitance of Test Jig and Connectors For PNP Test Circuits, Reverse All Voltage Polarities

Fig. 1 Switching Time Test Circuits

LMBTA56LT1G,S-LMBTA56LT1G

ELRCTRICAL CHARACTERISTICS CURVES

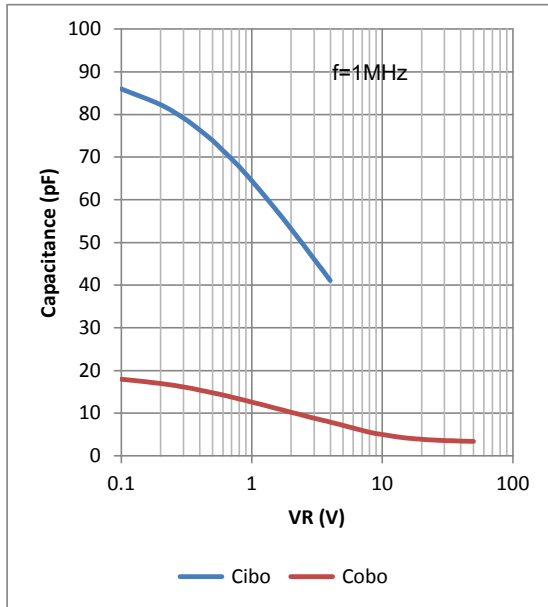

FIG. 2 Capacitance

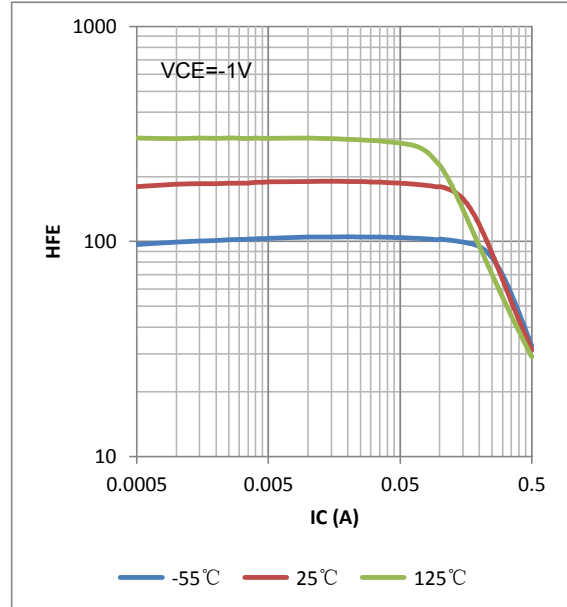

FIG.3 DC Current Gain

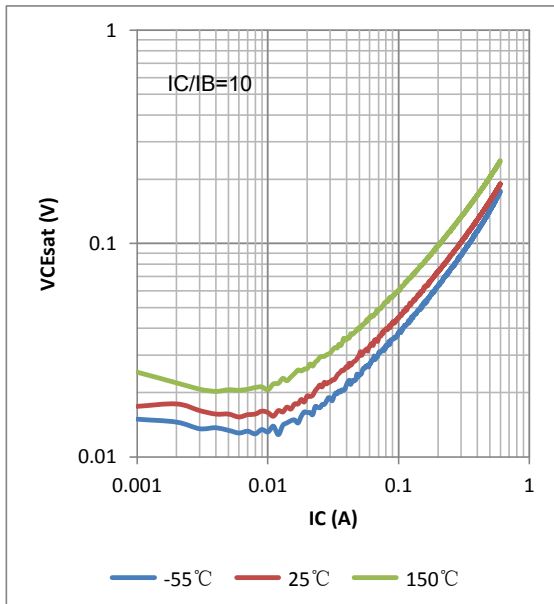

FIG.4 Collector Emitter Saturation Voltage vs. Collector Current

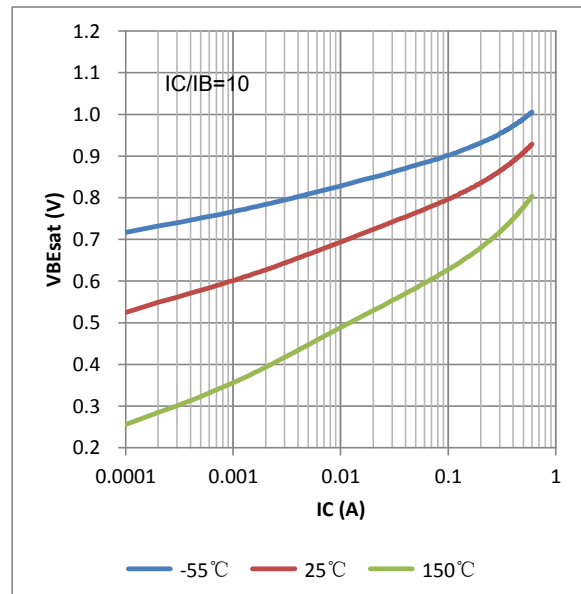

FIG.5 Base Emitter Saturation Voltage vs. Collector Current

LMBTA56LT1G,S-LMBTA56LT1G

ELRCTRICAL CHARACTERISTICS CURVES

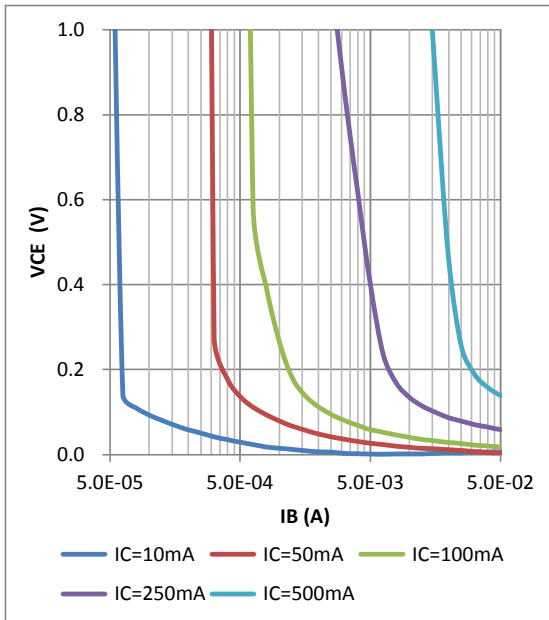

FIG.6 Collector Saturation Region

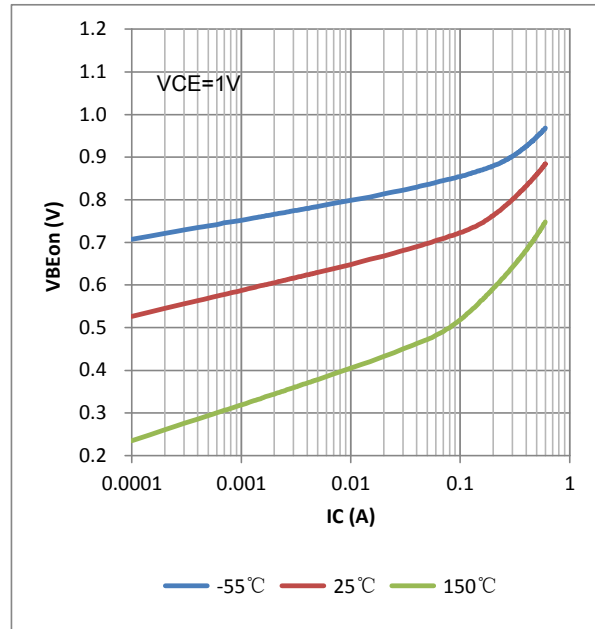

FIG.7 Base Emitter Voltage vs. Collector Current

LMBTA56LT1G,S-LMBTA56LT1G

SOT-23

NOTES:

1. DIMENSIONING AND TOLERANCING PER ANSI Y14.5M,1982
2. CONTROLLING DIMENSION: INCH.

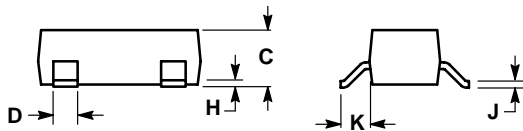
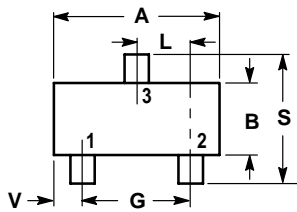

DIM	INCHES		MILLIMETERS	
	MIN	MAX	MIN	MAX
A	0.1102	0.1197	2.80	3.04
B	0.0472	0.0551	1.20	1.40
C	0.0350	0.0440	0.89	1.11
D	0.0150	0.0200	0.37	0.50
G	0.0701	0.0807	1.78	2.04
H	0.0005	0.0040	0.013	0.100
J	0.0034	0.0070	0.085	0.177
K	0.0140	0.0285	0.35	0.69
L	0.0350	0.0401	0.89	1.02
S	0.0830	0.1039	2.10	2.64
V	0.0177	0.0236	0.45	0.60

