



16-Bit, Parallel Input Multiplying Digital-to-Analog Converter

FEATURES

- ± 0.5 LSB DNL
- ± 1 LSB INL
- 16-Bit Monotonic
- Low Noise: $10 \text{ nV}/\sqrt{\text{Hz}}$
- Low Power: $I_{DD} = 2 \mu\text{A}$
- Analog Power Supply: $+2.7 \text{ V}$ to $+5.5 \text{ V}$
- 1.66 mA Full-Scale Current, with $V_{REF} = 10 \text{ V}$
- Settling Time: $0.5 \mu\text{s}$
- 4-Quadrant Multiplying Reference
- Reference Bandwidth: 8 MHz
- Reference Input: $\pm 15 \text{ V}$
- Reference Dynamics: -105 dB THD
- SSOP-28 Package
- Industry-Standard Pin Configuration

APPLICATIONS

- Automatic Test Equipment
- Instrumentation
- Digitally Controlled Calibration
- Industrial Control PLCs

DESCRIPTION

The DAC8820, a multiplying digital-to-analog converter (DAC), is designed to operate from a single 2.7 V to 5.5 V supply.

The applied external reference input voltage V_{REF} determines the full-scale output current. An internal feedback resistor (R_{FB}) provides temperature tracking for the full-scale output when combined with an external, current-to-voltage (I/V) precision amplifier.

A parallel interface offers high-speed communications. The DAC8820 is packaged in a space-saving SSOP-28 package and has an industry-standard pinout.

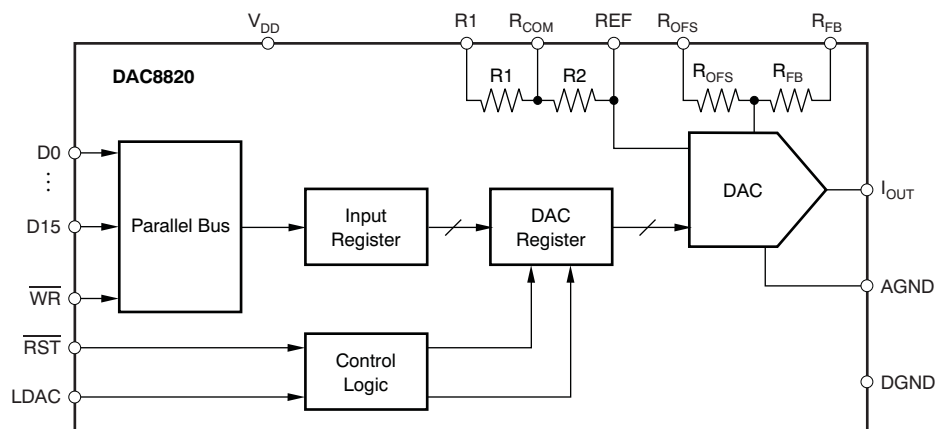

Please be aware that an important notice concerning availability, standard warranty, and use in critical applications of Texas Instruments semiconductor products and disclaimers thereto appears at the end of this data sheet.

All trademarks are the property of their respective owners.



This integrated circuit can be damaged by ESD. Texas Instruments recommends that all integrated circuits be handled with appropriate precautions. Failure to observe proper handling and installation procedures can cause damage.

ESD damage can range from subtle performance degradation to complete device failure. Precision integrated circuits may be more susceptible to damage because very small parametric changes could cause the device not to meet its published specifications.

ORDERING INFORMATION⁽¹⁾

PRODUCT	RELATIVE ACCURACY (LSB)	DIFFERENTIAL NONLINEARITY (LSB)	PACKAGE-LEAD (DESIGNATOR)	SPECIFIED TEMPERATURE RANGE	PACKAGE MARKING	ORDERING NUMBER	TRANSPORT MEDIA, QUANTITY
DAC8820IB	±2	±1	DB-28 (SSOP)	-40°C to +85°C	DAC8820	DAC8820IBDB	Tubes, 48
						DAC8820IBDBR	Tape and Reel, 2000
DAC8820IC	±1	±1	DB-28 (SSOP)	-40°C to +85°C	DAC8820	DAC8820ICDB	Tubes, 48
						DAC8820ICDBR	Tape and Reel, 2000

(1) For the most current package and ordering information see the Package Option Addendum at the end of this document, or see the TI web site at www.ti.com.

ABSOLUTE MAXIMUM RATINGS⁽¹⁾

Over operating free-air temperature range (unless otherwise noted)

	DAC8820	UNIT
V _{DD} to GND	-0.3 to +7	V
Digital input voltage to GND	-0.3 to +V _{DD} + 0.3	V
V (I _{OUT}) to GND	-0.3 to +V _{DD} + 0.3	V
REF, R _{OFS} , R _{FB} , R1, R _{COM} to AGND, DGND	±25	V
Operating temperature range	-40 to +85	°C
Storage temperature range	-65 to +150	°C
Junction temperature range (T _J max)	+125	°C
Power dissipation	(T _J max - T _A) / R _{θJA}	W
Thermal impedance, R _{θJA}	55	°C/W
ESD rating	Human Body Model (HBM)	4000
	Charged Device Model (CDM)	1000

(1) Stresses above those listed under absolute maximum ratings may cause permanent damage to the device. Exposure to absolute maximum conditions for extended periods may affect device reliability.

ELECTRICAL CHARACTERISTICS

All specifications at -40°C to $+85^{\circ}\text{C}$, $V_{\text{DD}} = +2.7\text{ V}$ to $+5.5\text{ V}$, $I_{\text{OUT}} = \text{virtual GND}$, $\text{GND} = 0\text{ V}$, $V_{\text{REF}} = 10\text{ V}$, and $T_{\text{A}} = \text{full operating temperature}$, unless otherwise noted.

PARAMETER	CONDITIONS	DAC8820			UNITS
		MIN	TYP	MAX	
STATIC PERFORMANCE					
Resolution		16			Bits
Relative accuracy	DAC8820IB			± 2	LSB
Relative accuracy	DAC8820IC			± 1	LSB
Differential nonlinearity			± 0.5	± 1	LSB
Output leakage current	Data = 0000h, $T_{\text{A}} = +25^{\circ}\text{C}$			5	nA
Output leakage current	Data = 0000h, $T_{\text{A}} = T_{\text{MAX}}$			10	nA
Full-scale gain error	Unipolar, data = FFFFh		2	± 16	LSB
	Bipolar, data = FFFFh		2	± 16	LSB
Full-scale temperature coefficient			1	2	ppm/ $^{\circ}\text{C}$
Bipolar zero scale error	$T_{\text{A}} = +25^{\circ}\text{C}$			± 5	LSB
	$T_{\text{A}} = T_{\text{MAX}}$			± 8	LSB
PSRR	Power-supply rejection ratio; $V_{\text{DD}} = 5\text{ V} \pm 10\%$		± 0.2	± 2.0	LSB/V
OUTPUT CHARACTERISTICS⁽¹⁾					
Output current			1.66		mA
Output capacitance	Code dependent		50		pF
REFERENCE INPUT					
V_{REF} Range		-15		15	V
R_{REF}	Input resistance (unipolar)	4.5	6	7.5	k Ω
Input capacitance			5		pF
R1/R2	R1/R2 resistance (bipolar)	9	12	15	k Ω
R_{OFS} , R_{FB}	Feedback and offset resistance	9	12	15	k Ω
LOGIC INPUTS AND OUTPUT⁽¹⁾					
Input low voltage	V_{IL}	$V_{\text{DD}} = +2.7\text{ V}$		0.6	V
	V_{IL}	$V_{\text{DD}} = +5\text{ V}$		0.8	V
Input high voltage	V_{IH}	$V_{\text{DD}} = +2.7\text{ V}$	2.1		V
	V_{IH}	$V_{\text{DD}} = +5\text{ V}$	2.4		V
Input leakage current	I_{IL}		0.001	1	μA
Input capacitance	C_{IL}			8	pF
INTERFACE TIMING, $V_{\text{DD}} = +5.0\text{V}$⁽¹⁾ (See Figure 40 and Table 1)					
	t_{DS}	Data to $\overline{\text{WR}}$ setup time	20		ns
	t_{DH}	Data to $\overline{\text{WR}}$ hold time	0		ns
	t_{WR}	$\overline{\text{WR}}$ pulse width	20		ns
	t_{LDAC}	LDAC pulse width	20		ns
Data setup time	t_{RST}	$\overline{\text{RST}}$ pulse width	20		ns
Data hold time	t_{LWD}	$\overline{\text{WR}}$ to LDAC delay time	0		ns
INTERFACE TIMING, $V_{\text{DD}} = +2.7\text{V}$⁽¹⁾ (See Figure 40 and Table 1)					
	t_{DS}	Data to $\overline{\text{WR}}$ setup time	35		ns
	t_{DH}	Data to $\overline{\text{WR}}$ hold time	0		ns
	t_{WR}	$\overline{\text{WR}}$ pulse width	35		ns
	t_{LDAC}	LDAC pulse width	35		ns
Data setup time	t_{RST}	$\overline{\text{RST}}$ pulse width	35		ns
Data hold time	t_{LWD}	$\overline{\text{WR}}$ to LDAC delay time	0		ns

(1) Specified by design and characterization; not production tested.

ELECTRICAL CHARACTERISTICS (continued)

All specifications at -40°C to $+85^{\circ}\text{C}$, $V_{\text{DD}} = +2.7\text{ V}$ to $+5.5\text{ V}$, $I_{\text{OUT}} = \text{virtual GND}$, $\text{GND} = 0\text{ V}$, $V_{\text{REF}} = 10\text{ V}$, and $T_{\text{A}} = \text{full operating temperature}$, unless otherwise noted.

PARAMETER	CONDITIONS	DAC8820			UNITS
		MIN	TYP	MAX	
POWER REQUIREMENTS					
V_{DD}		2.7		5.5	V
I_{DD} (normal operation)	Logic inputs = 0 V			5	μA
$V_{\text{DD}} = +4.5\text{ V}$ to $+5.5\text{ V}$	$V_{\text{IH}} = V_{\text{DD}}$ and $V_{\text{IL}} = \text{GND}$		3	5	μA
$V_{\text{DD}} = +2.7\text{ V}$ to $+3.6\text{ V}$	$V_{\text{IH}} = V_{\text{DD}}$ and $V_{\text{IL}} = \text{GND}$		1	2.5	μA
AC CHARACTERISTICS⁽²⁾					
Output current settling time			0.5		μs
Reference multiplying BW	$V_{\text{REF}} = 5\text{ V}_{\text{PP}}$, Data = FFFFh		8		MHz
DAC glitch impulse	$V_{\text{REF}} = 0\text{ V}$ to 10 V , Data = 7FFFh to 8000h to 7FFFh		2		nV-s
Feedthrough error $V_{\text{OUT}}/V_{\text{REF}}$	Data = 0000h, $V_{\text{REF}} = 10\text{ kHz}$, $\pm 10\text{ V}_{\text{PP}}$		-70		dB
Digital feedthrough	LDAC = Logic low, $V_{\text{REF}} = -10\text{ V}$ to $+10\text{ V}$ Any code change		1		nV-s
Total harmonic distortion	$V_{\text{REF}} = 6\text{ V}_{\text{RMS}}$, Data = FFFFh, $f = 1\text{ kHz}$		-105		dB
Output spot noise voltage			10		$\text{nV}/\sqrt{\text{Hz}}$

(2) Specified by design and characterization; not production tested.

PIN ASSIGNMENTS

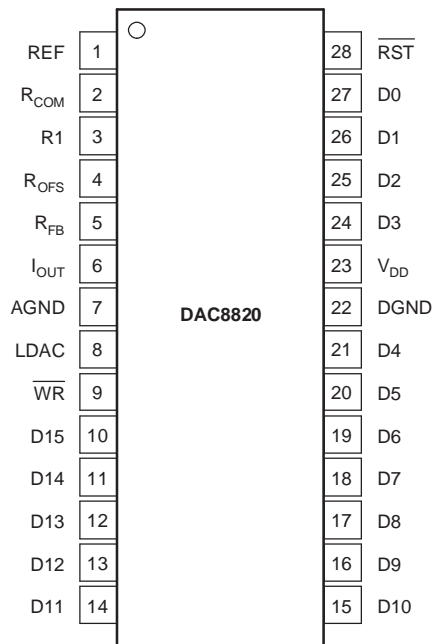

TERMINAL FUNCTIONS

PIN #	NAME	DESCRIPTION
1	REF	Reference input and 4-quadrant resistor (R2).
2	R _{COM}	Center tap of two 4-quadrant resistors (R1 and R2).
3	R1	4-quadrant resistor (R1).
4	R _{OFS}	Bipolar offset resistor
5	R _{FB}	Internal matching feedback resistor
6	I _{OUT}	DAC current output
7	AGND	Analog ground
8	LDAC	Digital input load DAC control. When LDAC is high, data is loaded from input register into a DAC register, updating the DAC output.
9	WR	Write control digital input. Active low. When WR is taken to logic low, data is loaded from the digital input pins (D0–D15) into a 16-bit input register.
10–21	D15–D4	Digital input data bits. D15 is MSB.
22	DGND	Digital ground
23	V _{DD}	Positive power supply
24–27	D3–D0	Digital Input data bits. D0 is LSB.
28	RST	Reset. Active low. When RST is taken to logic low, the DAC register is set to zero code, resulting in the DAC output being set to 0 V.

TYPICAL CHARACTERISTICS: $V_{DD} = +5\text{ V}$

At $T_A = +25^\circ\text{C}$, unless otherwise noted.

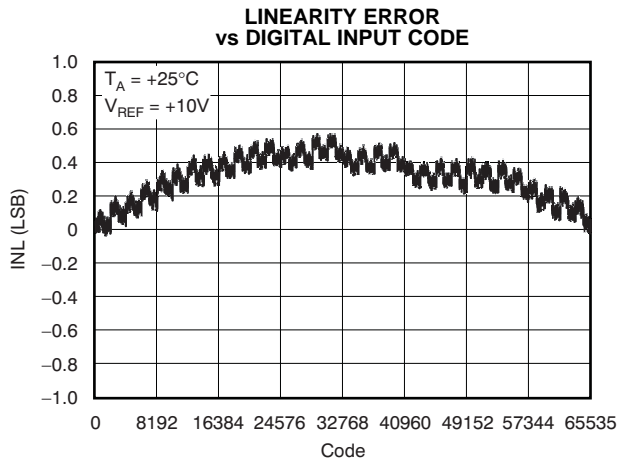

Figure 1.

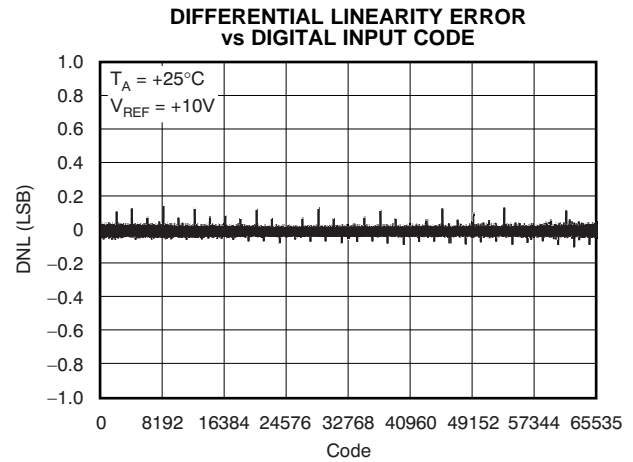

Figure 2.

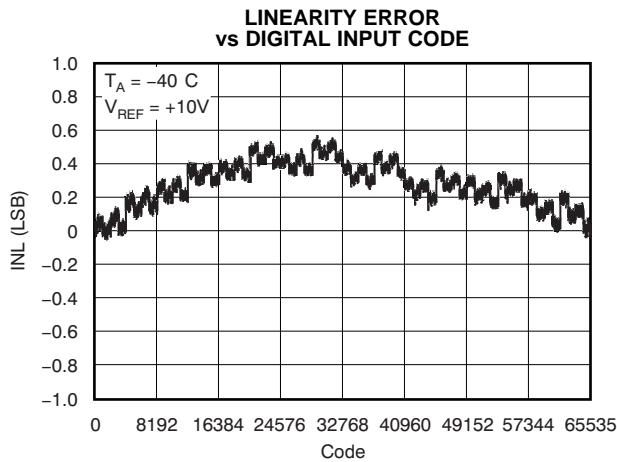

Figure 3.

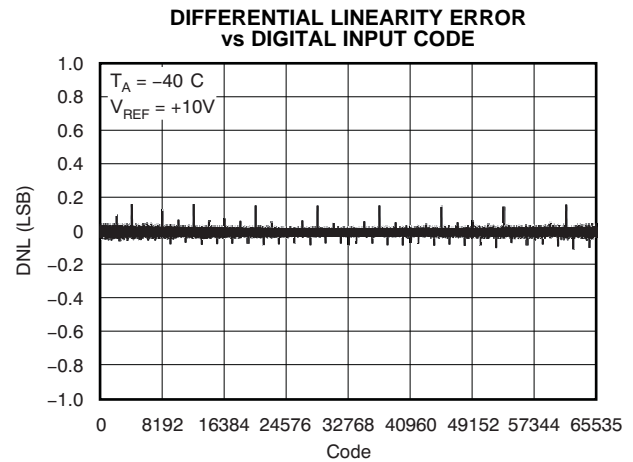

Figure 4.

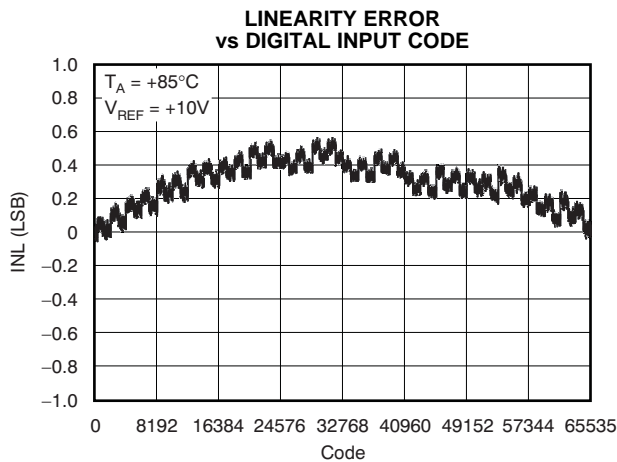

Figure 5.

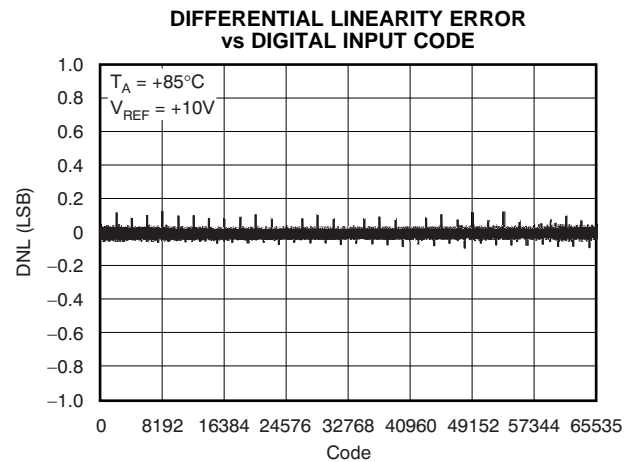

Figure 6.

TYPICAL CHARACTERISTICS: $V_{DD} = +5\text{ V}$ (continued)

At $T_A = +25^\circ\text{C}$, unless otherwise noted.

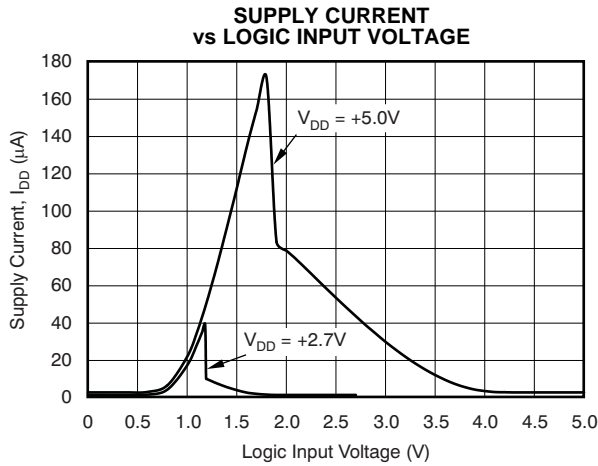

Figure 7.

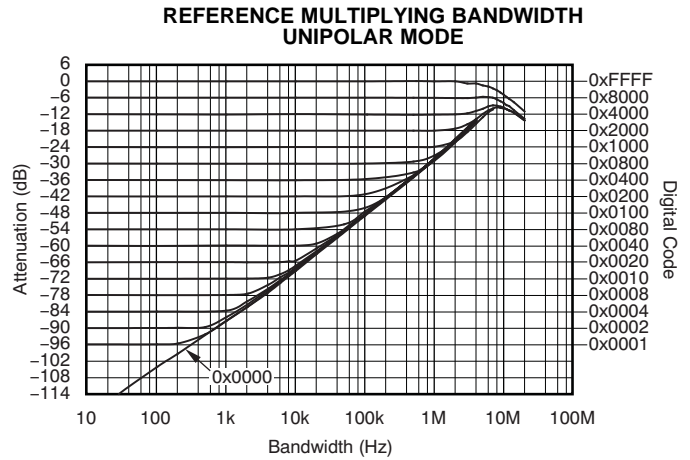

Figure 8.

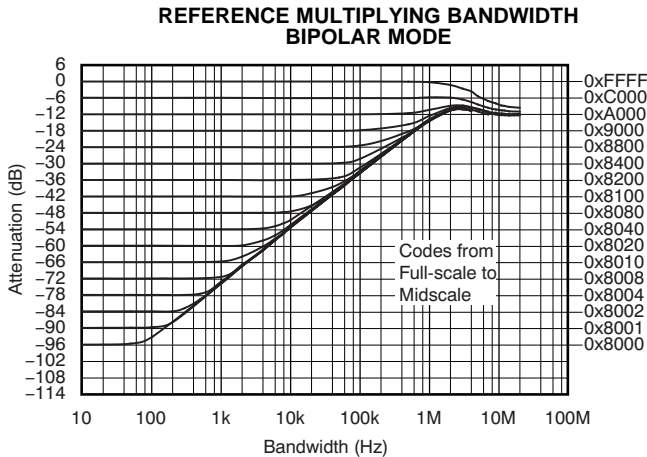

Figure 9.

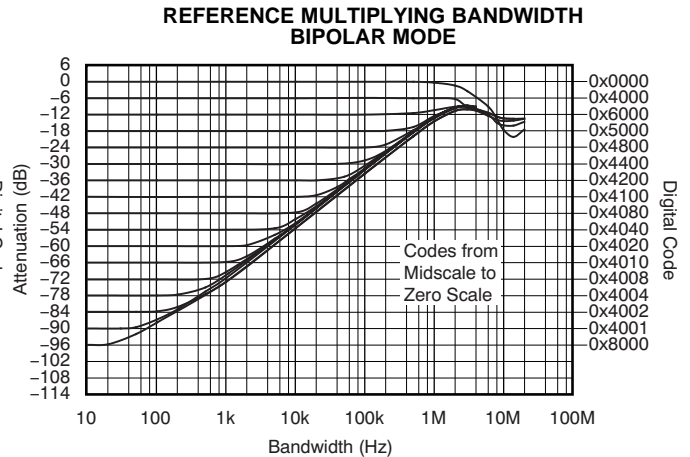

Figure 10.

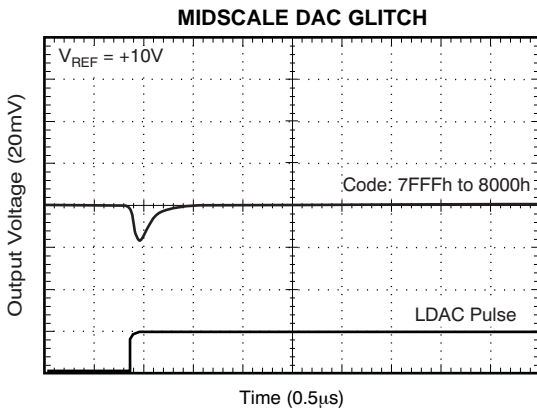

Figure 11.

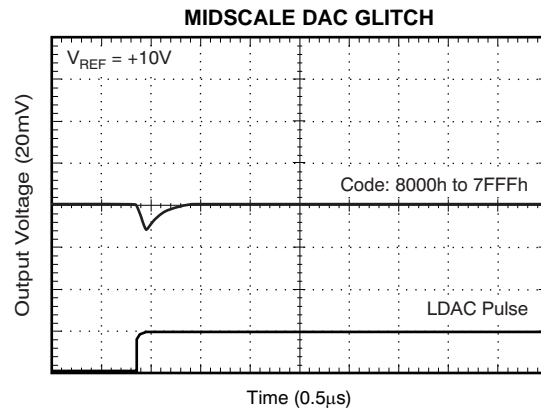

Figure 12.

TYPICAL CHARACTERISTICS: $V_{DD} = +5\text{ V}$ (continued)

At $T_A = +25^\circ\text{C}$, unless otherwise noted.

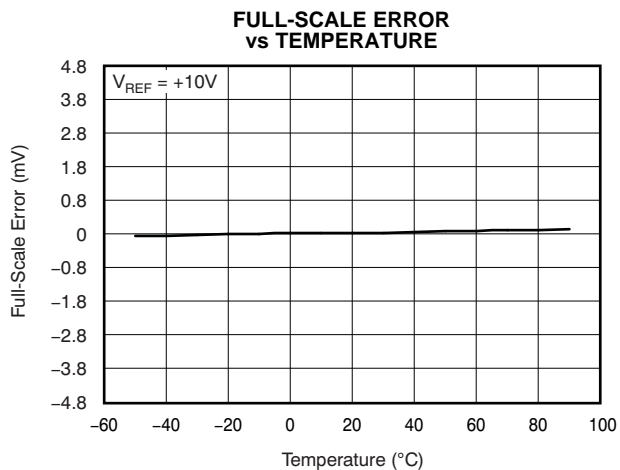

Figure 13.

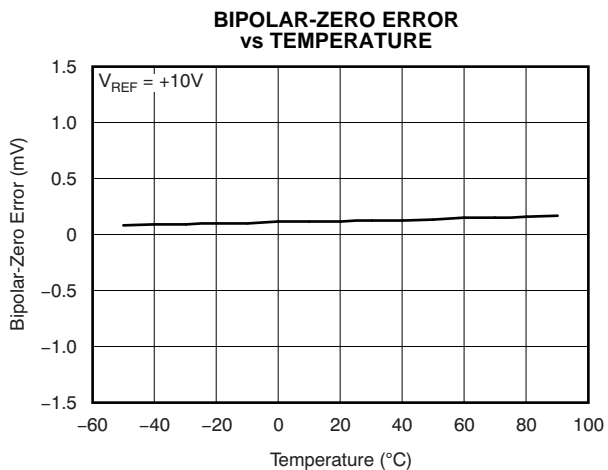

Figure 14.

TYPICAL CHARACTERISTICS: $V_{DD} = +2.7 V$

At $T_A = +25^\circ C$, unless otherwise noted.

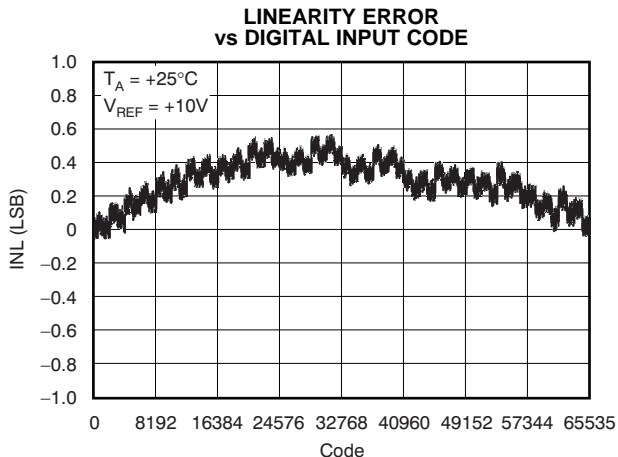

Figure 15.

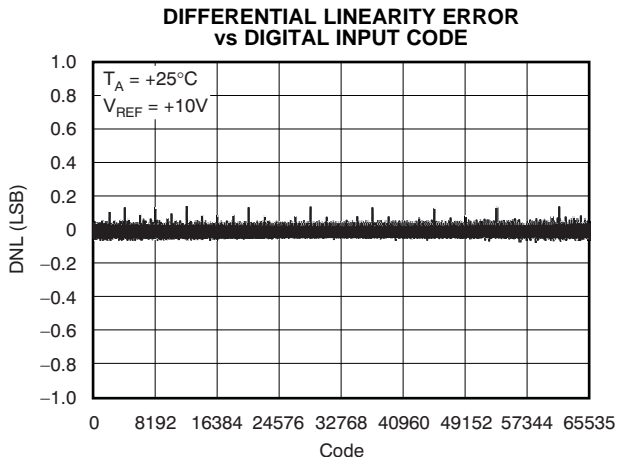

Figure 16.

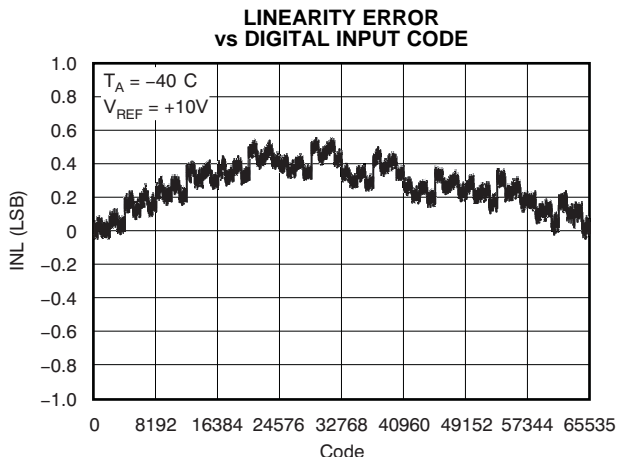

Figure 17.

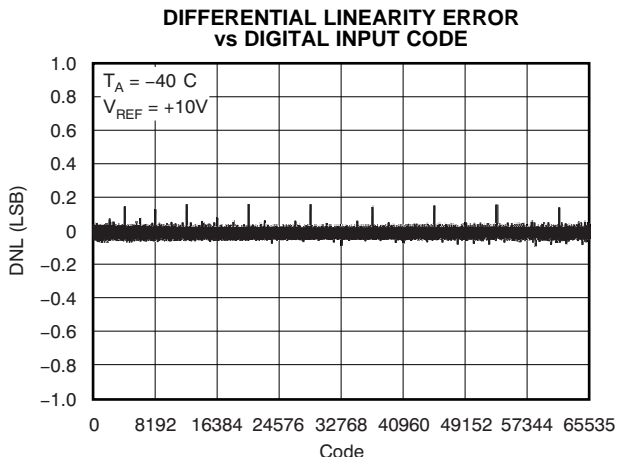

Figure 18.

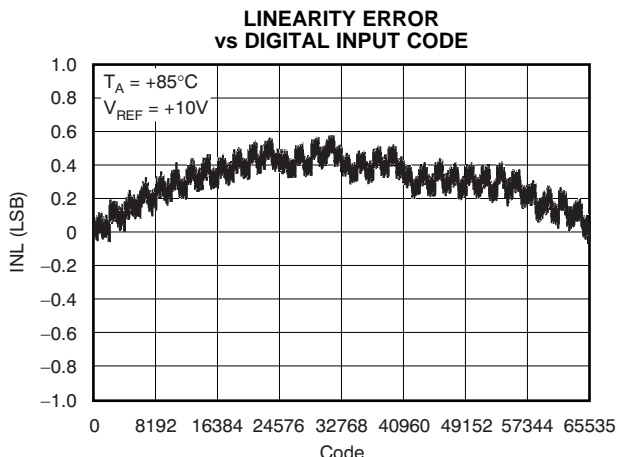

Figure 19.

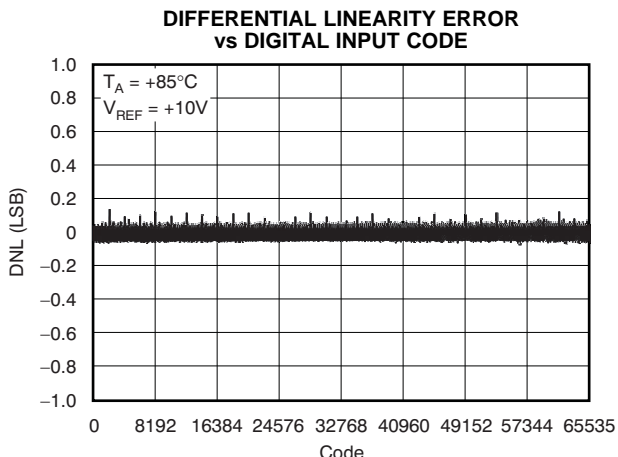

Figure 20.

TYPICAL CHARACTERISTICS: $V_{DD} = +2.7\text{ V}$ (continued)

At $T_A = +25^\circ\text{C}$, unless otherwise noted.

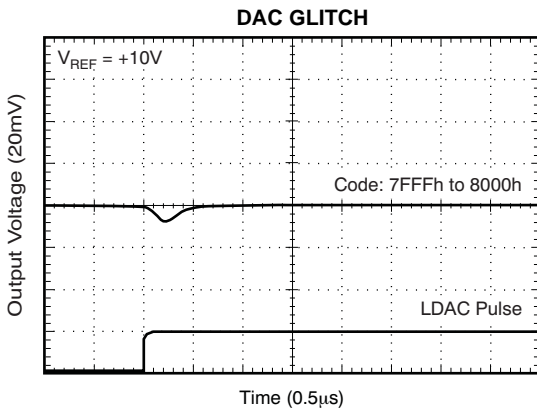

Figure 21.

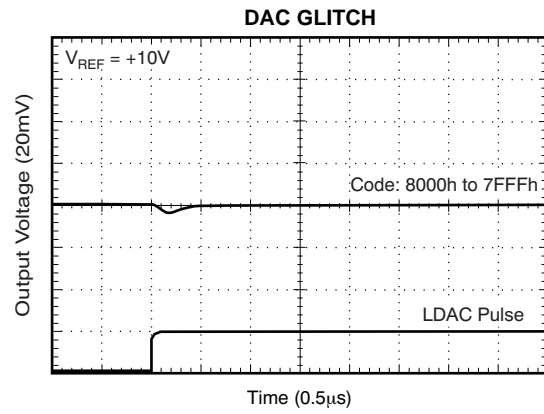

Figure 22.

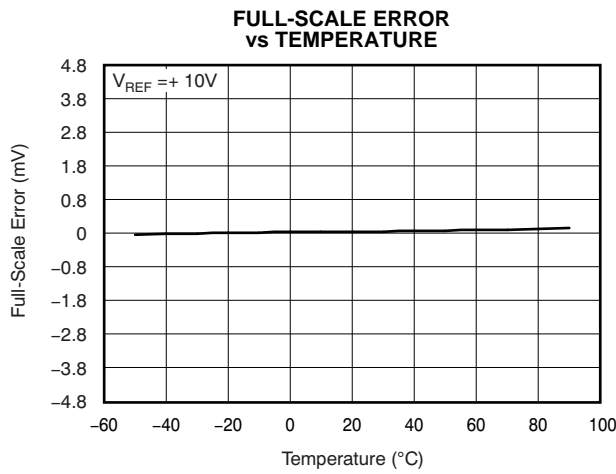

Figure 23.

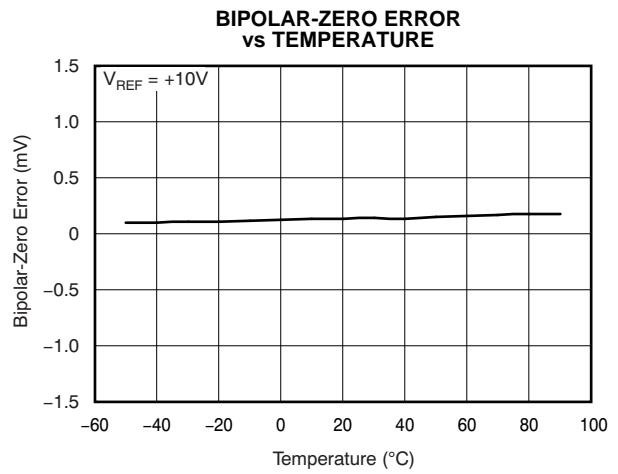

Figure 24.

TYPICAL CHARACTERISTICS

At $T_A = +25^\circ\text{C}$, unless otherwise noted.

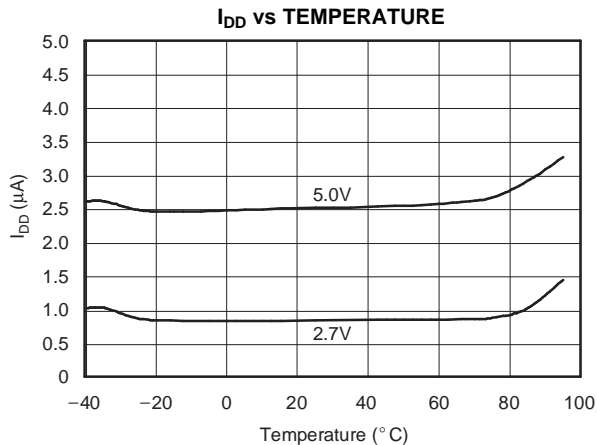

Figure 25.

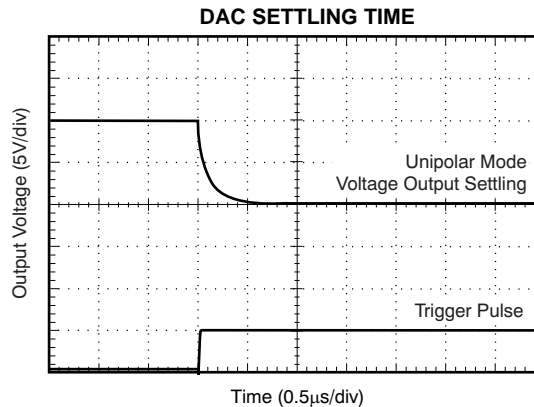

Figure 26.

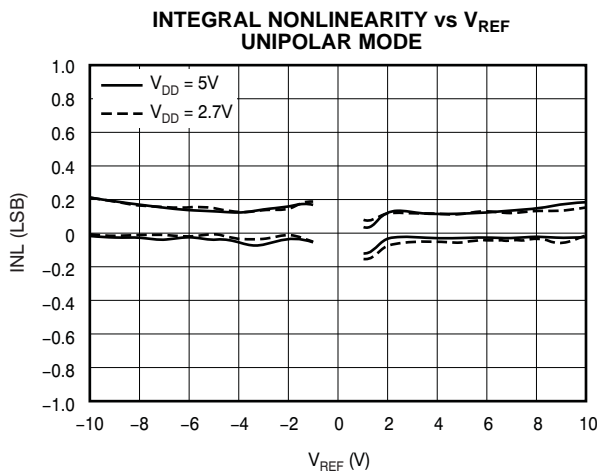

Figure 27.

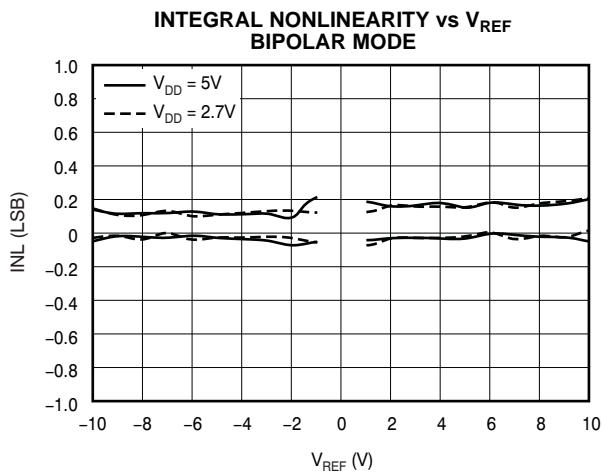

Figure 28.

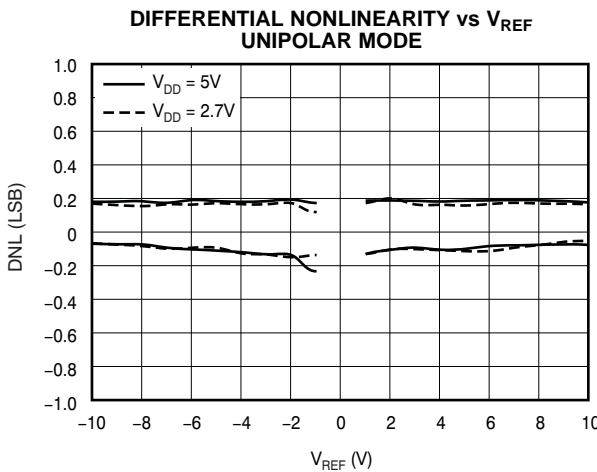

Figure 29.

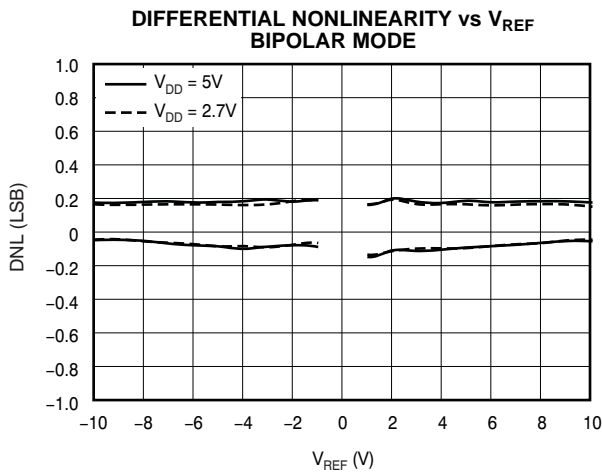

Figure 30.

TYPICAL CHARACTERISTICS (continued)

At $T_A = +25^\circ\text{C}$, unless otherwise noted.

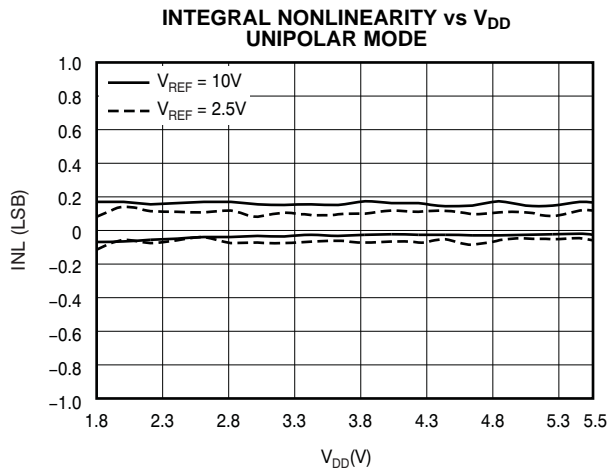

Figure 31.

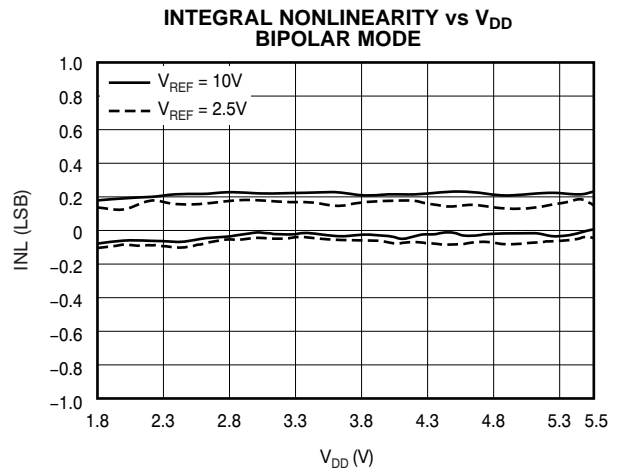

Figure 32.

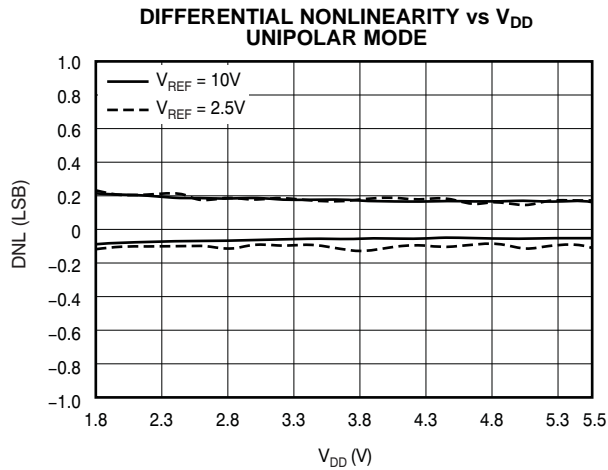

Figure 33.

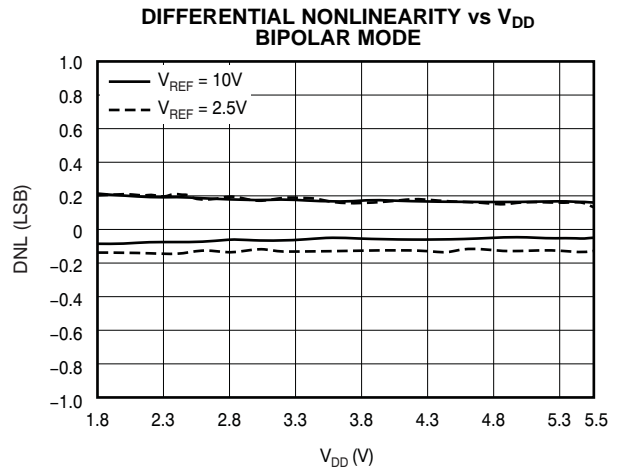

Figure 34.

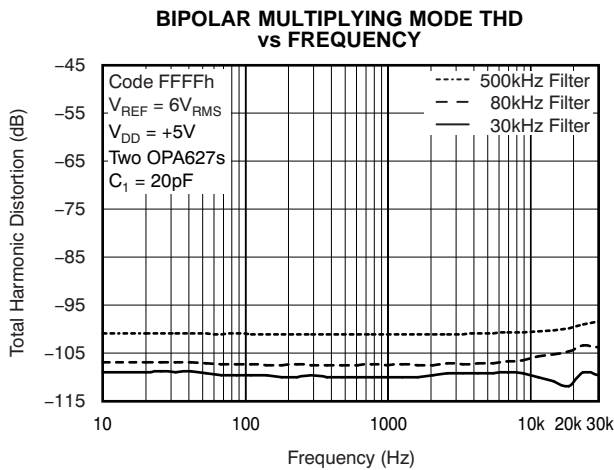

Figure 35.

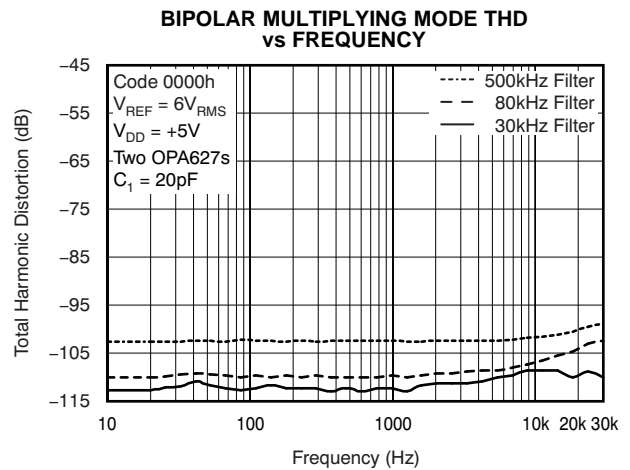

Figure 36.

TYPICAL CHARACTERISTICS (continued)

At T_A = +25°C, unless otherwise noted.

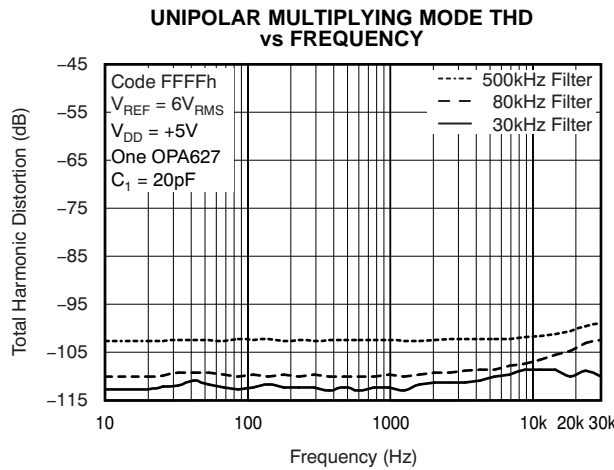

Figure 37.

THEORY OF OPERATION

The DAC8820 is a multiplying, single-channel current output, 16-bit DAC. The architecture, illustrated in Figure 38, is an R-2R ladder configuration with the three MSBs segmented. Each 2R leg of the ladder is either switched to GND or to the I_{OUT} terminal. The I_{OUT} terminal of the DAC is held at a virtual GND potential by the use of an external I/V converter op amp. The R-2R ladder is connected to an external reference input (V_{REF}) that determines the DAC full-scale current. The R-2R ladder presents a code independent load impedance to the external reference of 6 kΩ ±25%. The external reference voltage can vary in a range of –15 V to +15 V, thus providing bipolar I_{OUT} current operation. By using an external I/V converter op amp and the R_{FB} resistor in the DAC8820, an output voltage range of –V_{REF} to +V_{REF} can be generated.

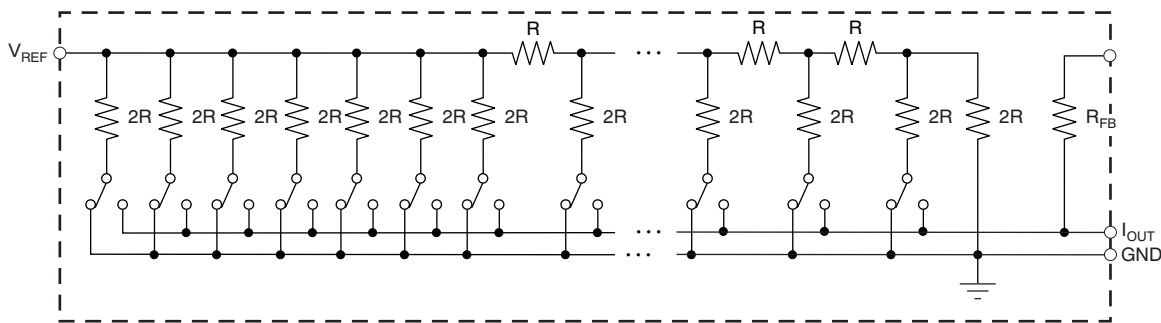

Figure 38. Equivalent R-2R DAC Circuit

The DAC output voltage is determined by V_{REF} and the digital data (D) according to Equation 1:

$$V_{OUT} = -V_{REF} \times \frac{D}{65536} \tag{1}$$

Each DAC code determines the 2R-leg switch position to either GND or I_{OUT}. The external I/V converter op amp noise gain will also change because the DAC output impedance (as seen looking into the I_{OUT} terminal) changes versus code. Because of this, the external I/V converter op amp must have a sufficiently low offset voltage such that the amplifier offset is not modulated by the DAC I_{OUT} terminal impedance change. External op amps with large offset voltages can produce INL errors in the transfer function of the DAC8820 because of offset modulation versus DAC code. For best linearity performance of the DAC8820, an op amp (OPA277) is recommended, as shown in Figure 39. This circuit allows V_{REF} to swing from –10 V to +10 V.

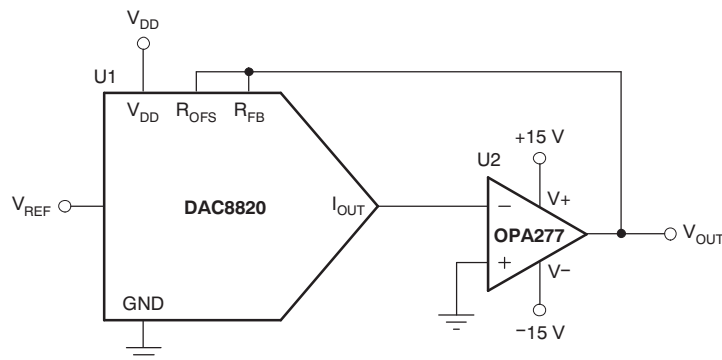

Figure 39. Voltage Output Configuration

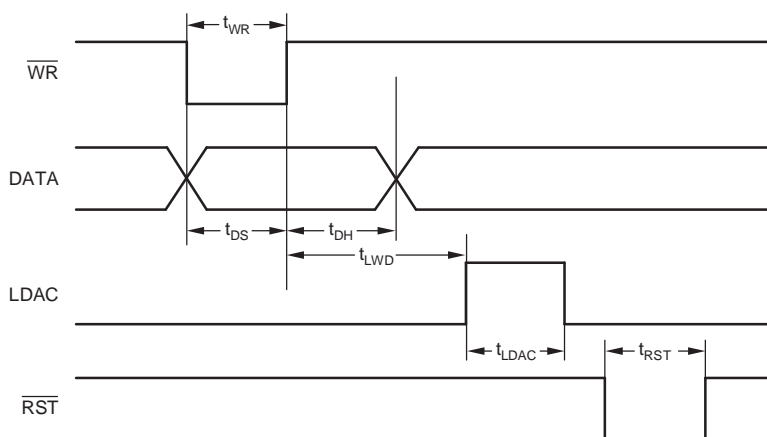



Figure 40. DAC8820 Timing Diagram

Table 1. Function of Control Inputs

CONTROL INPUTS			REGISTER OPERATION
$\overline{\text{RST}}$	$\overline{\text{WR}}$	LDAC	
0	X	X	Asynchronous operation. The DAC register is set to zero code, resulting in the DAC output being set to 0 V. The DAC input register contents are not reset by the RST signal.
1	0	0	Load the input register with all 16 data bits.
1	1	1	Load the DAC register with the contents of the input register.
1	0	1	The input and DAC register are transparent.
1			LDAC and $\overline{\text{WR}}$ are tied together and programmed as a pulse. The 16 data bits are loaded into the input register on the falling edge of the pulse and then loaded into the DAC register on the rising edge of the pulse.
1	1	0	No register operation.

APPLICATION INFORMATION

Multiplying Mode THD vs Frequency

Figure 35 and Figure 36 show the DAC8820 bipolar 4-quadrant multiplying mode total harmonic distortion (THD) versus frequency. Figure 35 shows the bipolar multiplying mode THD with the DAC8820 set to a full-scale code of FFFFh. Figure 36 shows the bipolar multiplying mode THD with the DAC8820 set to a minus full scale code of 0000h. In both graphs, two OPA627s are used for both the DAC output op amp and the reference inverting amplifier. A $6 V_{RMS}$ sine wave is used for the reference input V_{REF} and is swept in frequency from 10 Hz to 30 kHz. The THD levels versus frequency are illustrated at various DAC output filtering levels using an external ac-coupled low-pass filter.

Figure 37 illustrates the DAC8820 unipolar 2-quadrant multiplying mode THD versus frequency. The DAC8820 is set to a full-scale code of FFFFh. A single OPA627 is used for the DAC output op amp.

Stability Circuit

For a current-to-voltage (I/V) design, as shown in Figure 41, the DAC8820 current output (I_{OUT}) and the connection with the inverting node of the op amp should be as short as possible and laid out according to correct printed circuit board (PCB) layout design. For each code change there is a step function. If the gain bandwidth product (GBP) of the op amp is limited and parasitic capacitance is excessive at the inverting node, then gain peaking is possible. Therefore, a compensation capacitor C1 (4 pF to 20 pF, typ) can be added to the design for circuit stability, as shown in Figure 41.

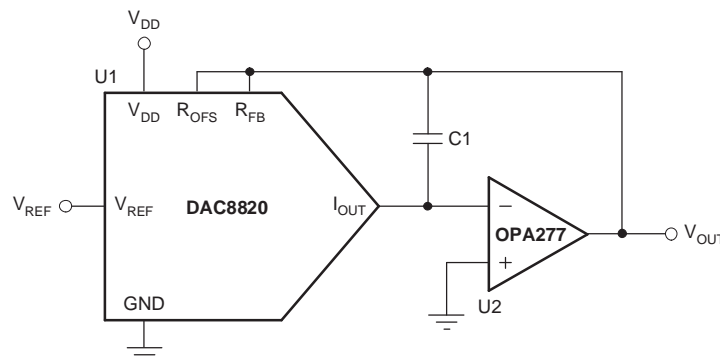

Figure 41. Gain Peaking Prevention Circuit with Compensation Capacitor

Bipolar Output Circuit

The DAC8820, as a 4-quadrant multiplying DAC, can be used to generate a bipolar output. The polarity of the full-scale output (I_{OUT}) is the inverse of the input reference voltage at V_{REF} .

Using a dual op amp, such as the OPA2277, full 4-quadrant operation can be achieved with minimal components. Figure 42 demonstrates a $\pm 10 V_{OUT}$ circuit with a fixed +10 V reference.

$$V_{OUT} = \left(\frac{D}{32,768} - 1 \right) \times V_{REF} \quad (2)$$

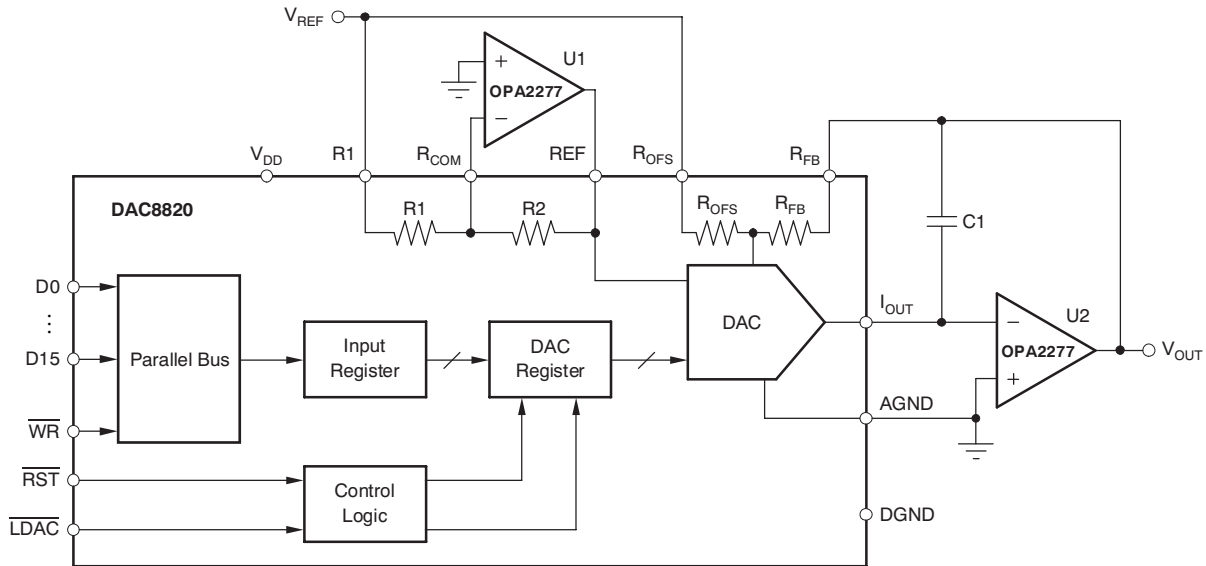

Figure 42. Bipolar Output Circuit

Programmable Current Source Circuit

A DAC8820 can be integrated into the circuit in Figure 43 to implement an improved Howland current pump for precise V/I conversions. Bidirectional current flow and high-voltage compliance are two features of the circuit. With a matched resistor network, the load current of the circuit is shown by Equation 3:

$$I_L = \frac{(R2 + R3) / R1}{R3} \times V_{REF} \times D \quad (3)$$

The value of R3 in the previous equation can be reduced to increase the output current drive of U3. U3 can drive ± 20 mA in both directions with voltage compliance limited up to 15 V by the U3 voltage supply. Elimination of the circuit compensation capacitor (C1) in the circuit is not suggested as a result of the change in the output impedance (Z_O), according to Equation 4:

$$Z_O = \frac{R1'R3(R1 + R2)}{R1(R2' + R3') - R1'(R2 + R3)} \quad (4)$$

As shown in Equation 4, Z_O with matched resistors is infinite and the circuit is optimum for use as a current source. However, if unmatched resistors are used, Z_O is positive or negative with negative output impedance being a potential cause of oscillation. Therefore, by incorporating C1 into the circuit, possible oscillation problems are eliminated. The value of C1 can be determined for critical applications; for most applications, however, a value of several pF is suggested.

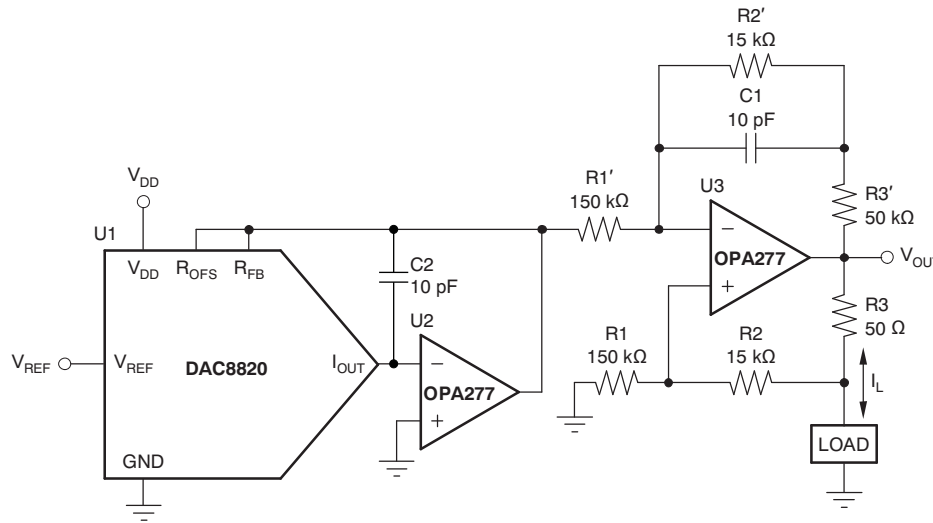

Figure 43. Programmable Bidirectional Current Source Circuit

Cross-Reference

The DAC8820 has an industry-standard pinout. [Table 2](#) provides the cross-reference information.

Table 2. Cross-Reference

PRODUCT	BIT	INL (LSB)	DNL (LSB)	SPECIFIED TEMPERATURE RANGE	PACKAGE DESCRIPTION	PACKAGE OPTION	CROSS-REFERENCE PART
DAC8820IBDB	16	±2	±1	-40°C to +85°C	SSOP-28	SSOP-28	LTC1597BIG
DAC8820ICDB	16	±1	±1	-40°C to +85°C	SSOP-28	SSOP-28	LTC1597AIG

Revision History

NOTE: Page numbers for previous revisions may differ from page numbers in the current version.

Changes from Revision C (June 2006) to Revision D	Page
• Changed front page block diagram.....	1
• Changed pin 28 description text in <i>Terminal Functions</i> table.....	4
• Changed first row description text in Table 1	13
• Changed Figure 42	15

Changes from Revision B (March 2006) to Revision C	Page
• Changed from "voltage-to-current" to "current-to-voltage".....	1
• Added bipolar zero scale error specification.....	3

PACKAGING INFORMATION

Orderable Device	Status (1)	Package Type	Package Drawing	Pins	Package Qty	Eco Plan (2)	Lead finish/ Ball material (6)	MSL Peak Temp (3)	Op Temp (°C)	Device Marking (4/5)	Samples
DAC8820IBDB	ACTIVE	SSOP	DB	28	50	RoHS & Green	NIPDAU	Level-2-260C-1 YEAR	-40 to 85	DAC8820	Samples
DAC8820IBDBR	ACTIVE	SSOP	DB	28	2000	RoHS & Green	NIPDAU	Level-2-260C-1 YEAR	-40 to 85	DAC8820	Samples
DAC8820ICDB	ACTIVE	SSOP	DB	28	50	RoHS & Green	NIPDAU	Level-2-260C-1 YEAR	-40 to 85	DAC8820	Samples
DAC8820ICDBG4	ACTIVE	SSOP	DB	28	50	RoHS & Green	NIPDAU	Level-2-260C-1 YEAR	-40 to 85	DAC8820	Samples
DAC8820ICDBR	ACTIVE	SSOP	DB	28	2000	RoHS & Green	NIPDAU	Level-2-260C-1 YEAR	-40 to 85	DAC8820	Samples

(1) The marketing status values are defined as follows:

ACTIVE: Product device recommended for new designs.

LIFEBUY: TI has announced that the device will be discontinued, and a lifetime-buy period is in effect.

NRND: Not recommended for new designs. Device is in production to support existing customers, but TI does not recommend using this part in a new design.

PREVIEW: Device has been announced but is not in production. Samples may or may not be available.

OBSELETE: TI has discontinued the production of the device.

(2) **RoHS:** TI defines "RoHS" to mean semiconductor products that are compliant with the current EU RoHS requirements for all 10 RoHS substances, including the requirement that RoHS substance do not exceed 0.1% by weight in homogeneous materials. Where designed to be soldered at high temperatures, "RoHS" products are suitable for use in specified lead-free processes. TI may reference these types of products as "Pb-Free".

RoHS Exempt: TI defines "RoHS Exempt" to mean products that contain lead but are compliant with EU RoHS pursuant to a specific EU RoHS exemption.

Green: TI defines "Green" to mean the content of Chlorine (Cl) and Bromine (Br) based flame retardants meet JS709B low halogen requirements of <=1000ppm threshold. Antimony trioxide based flame retardants must also meet the <=1000ppm threshold requirement.

(3) MSL, Peak Temp. - The Moisture Sensitivity Level rating according to the JEDEC industry standard classifications, and peak solder temperature.

(4) There may be additional marking, which relates to the logo, the lot trace code information, or the environmental category on the device.

(5) Multiple Device Markings will be inside parentheses. Only one Device Marking contained in parentheses and separated by a "~" will appear on a device. If a line is indented then it is a continuation of the previous line and the two combined represent the entire Device Marking for that device.

(6) Lead finish/Ball material - Orderable Devices may have multiple material finish options. Finish options are separated by a vertical ruled line. Lead finish/Ball material values may wrap to two lines if the finish value exceeds the maximum column width.

Important Information and Disclaimer: The information provided on this page represents TI's knowledge and belief as of the date that it is provided. TI bases its knowledge and belief on information provided by third parties, and makes no representation or warranty as to the accuracy of such information. Efforts are underway to better integrate information from third parties. TI has taken and continues to take reasonable steps to provide representative and accurate information but may not have conducted destructive testing or chemical analysis on incoming materials and chemicals. TI and TI suppliers consider certain information to be proprietary, and thus CAS numbers and other limited information may not be available for release.

In no event shall TI's liability arising out of such information exceed the total purchase price of the TI part(s) at issue in this document sold by TI to Customer on an annual basis.

TAPE AND REEL INFORMATION

QUADRANT ASSIGNMENTS FOR PIN 1 ORIENTATION IN TAPE

*All dimensions are nominal

Device	Package Type	Package Drawing	Pins	SPQ	Reel Diameter (mm)	Reel Width W1 (mm)	A0 (mm)	B0 (mm)	K0 (mm)	P1 (mm)	W (mm)	Pin1 Quadrant
DAC8820IBDBR	SSOP	DB	28	2000	330.0	16.4	8.1	10.4	2.5	12.0	16.0	Q1
DAC8820ICDBR	SSOP	DB	28	2000	330.0	16.4	8.1	10.4	2.5	12.0	16.0	Q1

TAPE AND REEL BOX DIMENSIONS

*All dimensions are nominal

Device	Package Type	Package Drawing	Pins	SPQ	Length (mm)	Width (mm)	Height (mm)
DAC8820IBDBR	SSOP	DB	28	2000	350.0	350.0	43.0
DAC8820ICDBR	SSOP	DB	28	2000	350.0	350.0	43.0



NOTES:

1. All linear dimensions are in millimeters. Any dimensions in parenthesis are for reference only. Dimensioning and tolerancing per ASME Y14.5M.
2. This drawing is subject to change without notice.
3. This dimension does not include mold flash, protrusions, or gate burrs. Mold flash, protrusions, or gate burrs shall not exceed 0.15 mm per side.
4. This dimension does not include interlead flash. Interlead flash shall not exceed 0.25 mm per side.
5. Reference JEDEC registration MO-150.

EXAMPLE BOARD LAYOUT

DB0028A

SSOP - 2 mm max height

SMALL OUTLINE PACKAGE

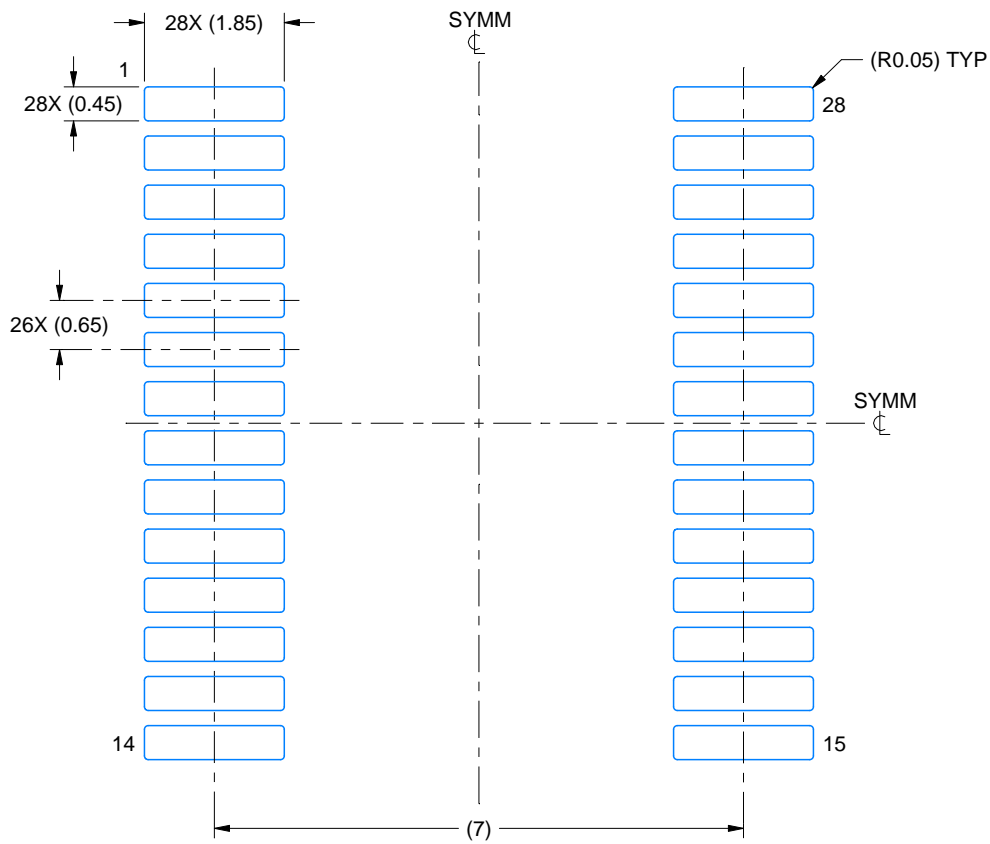

LAND PATTERN EXAMPLE
EXPOSED METAL SHOWN
SCALE: 10X

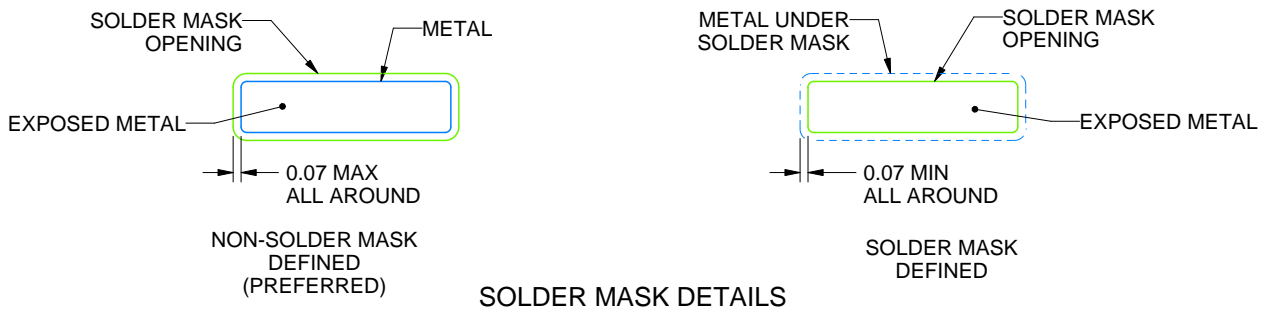

4214853/B 03/2018

NOTES: (continued)

- 6. Publication IPC-7351 may have alternate designs.
- 7. Solder mask tolerances between and around signal pads can vary based on board fabrication site.

EXAMPLE STENCIL DESIGN

DB0028A

SSOP - 2 mm max height

SMALL OUTLINE PACKAGE



NOTES: (continued)

8. Laser cutting apertures with trapezoidal walls and rounded corners may offer better paste release. IPC-7525 may have alternate design recommendations.
9. Board assembly site may have different recommendations for stencil design.

IMPORTANT NOTICE AND DISCLAIMER

TI PROVIDES TECHNICAL AND RELIABILITY DATA (INCLUDING DATASHEETS), DESIGN RESOURCES (INCLUDING REFERENCE DESIGNS), APPLICATION OR OTHER DESIGN ADVICE, WEB TOOLS, SAFETY INFORMATION, AND OTHER RESOURCES "AS IS" AND WITH ALL FAULTS, AND DISCLAIMS ALL WARRANTIES, EXPRESS AND IMPLIED, INCLUDING WITHOUT LIMITATION ANY IMPLIED WARRANTIES OF MERCHANTABILITY, FITNESS FOR A PARTICULAR PURPOSE OR NON-INFRINGEMENT OF THIRD PARTY INTELLECTUAL PROPERTY RIGHTS.

These resources are intended for skilled developers designing with TI products. You are solely responsible for (1) selecting the appropriate TI products for your application, (2) designing, validating and testing your application, and (3) ensuring your application meets applicable standards, and any other safety, security, or other requirements. These resources are subject to change without notice. TI grants you permission to use these resources only for development of an application that uses the TI products described in the resource. Other reproduction and display of these resources is prohibited. No license is granted to any other TI intellectual property right or to any third party intellectual property right. TI disclaims responsibility for, and you will fully indemnify TI and its representatives against, any claims, damages, costs, losses, and liabilities arising out of your use of these resources.

TI's products are provided subject to TI's Terms of Sale (<https://www.ti.com/legal/termsofsale.html>) or other applicable terms available either on [ti.com](https://www.ti.com) or provided in conjunction with such TI products. TI's provision of these resources does not expand or otherwise alter TI's applicable warranties or warranty disclaimers for TI products.

Mailing Address: Texas Instruments, Post Office Box 655303, Dallas, Texas 75265
Copyright © 2021, Texas Instruments Incorporated