



P-Channel Enhancement-Mode Lateral MOSFET

Features

- ▶ Ultra-low threshold
- ▶ High input impedance
- ▶ Low input capacitance
- ▶ Fast switching speeds
- ▶ Low on-resistance
- ▶ Freedom from secondary breakdown
- ▶ Low input and output leakage

Applications

- ▶ Logic level interfaces
- ▶ Solid state relays
- ▶ Battery operated systems
- ▶ Photo voltaic drives
- ▶ Analog switches
- ▶ General purpose line drivers

General Description

These enhancement-mode (normally-off) transistors utilize a lateral MOS structure and Supertex's well-proven silicon-gate manufacturing process. This combination produces devices with the power handling capabilities of bipolar transistors and with the high input impedance and negative temperature coefficient inherent in MOS devices.

Characteristic of all MOS structures, these devices are free from thermal runaway and thermally induced secondary breakdown. The low threshold voltage and low on-resistance characteristics are ideally suited for hand held, battery operated applications.

Ordering Information

Device	Package Options		BV _{DSS} /BV _{DGS} (V)	R _{DS(ON)} (Ω)	V _{GS(TH)} (max) (V)	I _{D(ON)} (min) (A)
	8-Lead SOIC (Narrow Body)	TO-92				
LP0701	LP0701LG-G	LP0701N3-G	-16.5	1.5	-1.0	-1.25

-G indicates package is RoHS compliant ('Green')



Pin Configurations

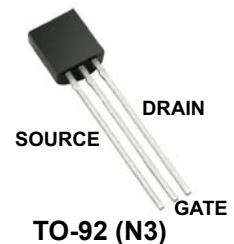

Absolute Maximum Ratings

Parameter	Value
Drain-to-source voltage	BV _{DSS}
Drain-to-gate voltage	BV _{DGS}
Gate-to-source voltage	±10V
Operating and storage temperature	-55°C to +150°C
Soldering temperature*	+300°C

Absolute Maximum Ratings are those values beyond which damage to the device may occur. Functional operation under these conditions is not implied. Continuous operation of the device at the absolute rating level may affect device reliability. All voltages are referenced to device ground.

* Distance of 1.6mm from case for 10 seconds.

Product Marking

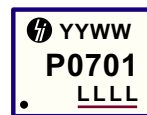

YY = Year Sealed
 WW = Week Sealed
 L = Lot Number
 _____ = "Green" Packaging

Package may or may not include the following marks: Si or

8-Lead SOIC (LG)

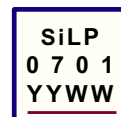

YY = Year Sealed
 WW = Week Sealed
 _____ = "Green" Packaging

Package may or may not include the following marks: Si or

TO-92 (N3)

Thermal Characteristics

Package	I_D (continuous) [†] (mA)	I_D (pulsed) [†] (A)	Power Dissipation @ $T_c = 25^\circ\text{C}$ (W)	θ_{jc} ($^\circ\text{C}/\text{W}$)	θ_{ja} ($^\circ\text{C}/\text{W}$)	I_{DR} (mA)	I_{DRM}^{\ddagger} (A)
8-Lead SOIC	-700	-1.25	1.5 [‡]	83	104 [‡]	-700	-1.25
TO-92	-500	-1.25	1.0	125	170	-500	-1.25

Notes:

- [†] I_D (continuous) is limited by max rated T_j .
- [‡] Mounted on FR4 board, 25mm x 25mm x 1.57mm

Electrical Characteristics ($T_A = 25^\circ\text{C}$ unless otherwise specified)

Sym	Parameter	Min	Typ	Max	Units	Conditions
BV_{DSS}	Drain-to-source breakdown voltage	-16.5	-	-	V	$V_{GS} = 0V, I_D = -1.0mA$
V_{GS}	Gate threshold voltage	-0.5	-0.7	-1.0	V	$V_{GS} = V_{DS}, I_D = -1.0mA$
$\Delta V_{GS(th)}$	Change in $V_{GS(th)}$ with temperature	-	-	-4.0	mV/ $^\circ\text{C}$	$V_{GS} = V_{DS}, I_D = -1.0mA$
I_{GSS}	Gate body leakage	-	-	-100	nA	$V_{GS} = \pm 10V, V_{DS} = 0V$
I_{DSS}	Zero gate voltage drain current	-	-	-100	nA	$V_{DS} = -15V, V_{GS} = 0V$
$I_{D(ON)}$	On-state drain current	-	-0.4	-	A	$V_{GS} = V_{DS} = -2.0V$
		-0.6	-1.0	-		$V_{GS} = V_{DS} = -3.0V$
		-1.25	-2.3	-		$V_{GS} = V_{DS} = -5.0V$
$R_{DS(ON)}$	Static drain-to-source on-state resistance	-	2.0	4.0	Ω	$V_{GS} = -2.0V, I_D = -50mA$
		-	1.7	2.0		$V_{GS} = -3.0V, I_D = -150mA$
		-	1.3	1.5		$V_{GS} = -5.0V, I_D = -300mA$
$\Delta R_{DS(ON)}$	Change in $R_{DS(ON)}$ with temperature	-	-	0.75	%/ $^\circ\text{C}$	$V_{GS} = -5.0V, I_D = -300mA$
G_{FS}	Forward transconductance	500	700	-	mmho	$V_{GS} = -15V, I_D = -1.0A$
C_{ISS}	Input capacitance	-	120	250	pF	$V_{GS} = 0V,$ $V_{DS} = -15V,$ $f = 1.0MHz$
C_{OSS}	Common source output capacitance	-	100	125		
C_{RSS}	Reverse transfer capacitance	-	40	60		
$t_{d(ON)}$	Turn-on delay time	-	-	20	ns	$V_{DD} = -15V,$ $I_D = -1.25A,$ $R_{GEN} = 25\Omega$
t_r	Rise time	-	-	20		
$t_{d(OFF)}$	Turn-off delay time	-	-	30		
t_f	Fall time	-	-	30		
V_{SD}	Diode forward voltage drop	-	-1.2	-1.5	V	$V_{GS} = 0V, I_{SD} = -500mA$

Notes:

1. All D.C. parameters 100% tested at 25 $^\circ\text{C}$ unless otherwise stated. (Pulse test: 300 μs pulse, 2% duty cycle.)
2. All A.C. parameters sample tested.

Switching Waveforms and Test Circuit

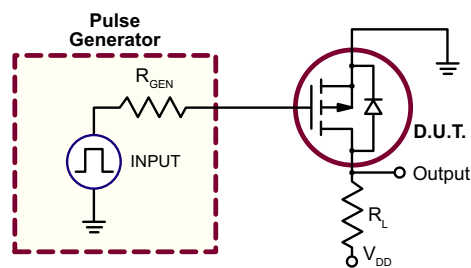
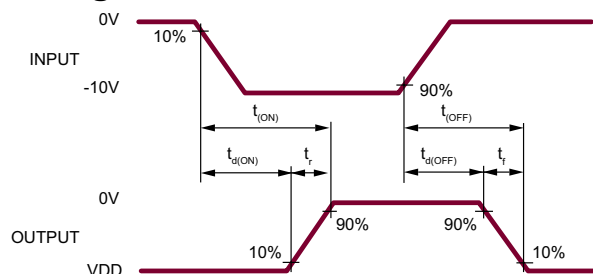

Typical Performance Curves

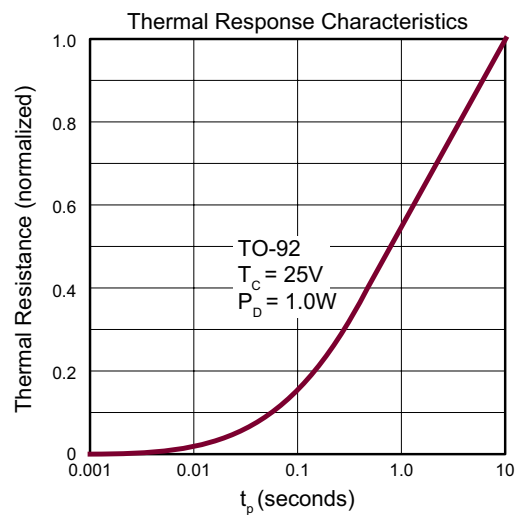
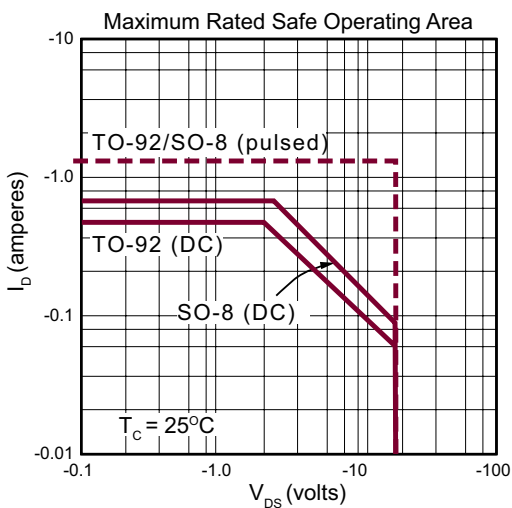
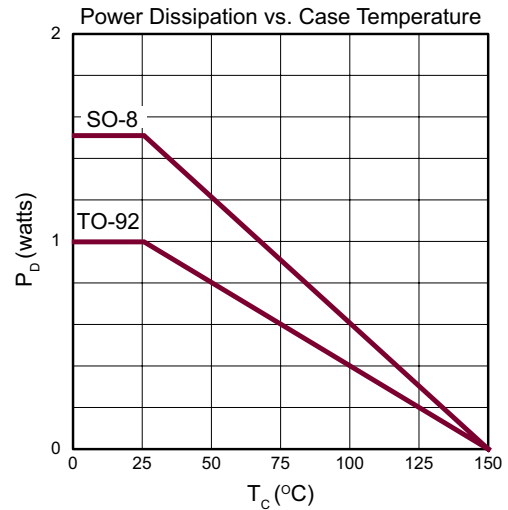
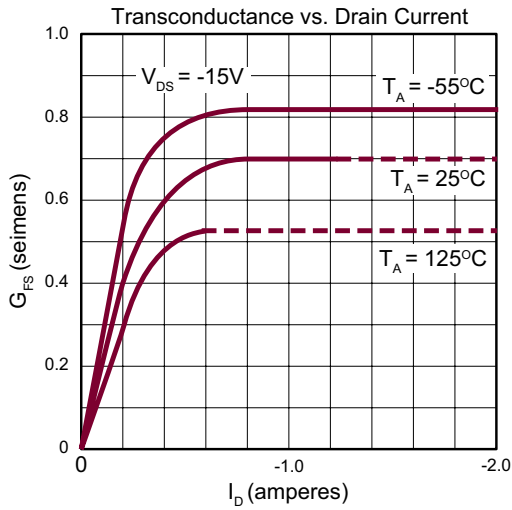
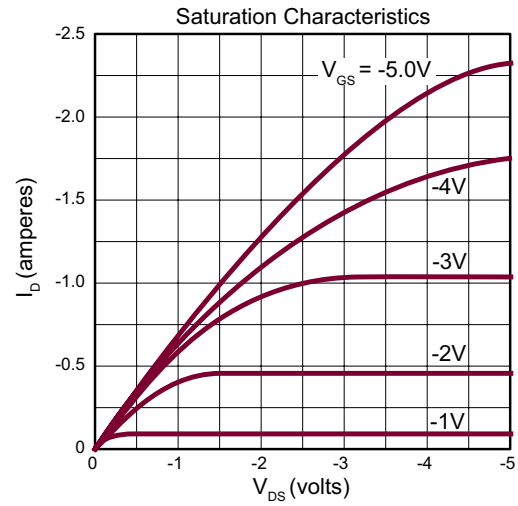
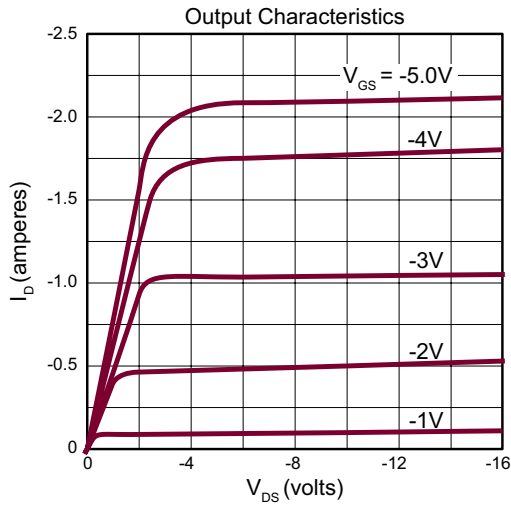

Typical Performance Curves (cont.)

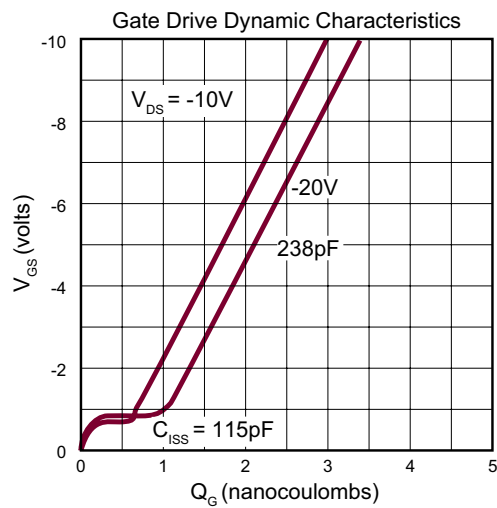
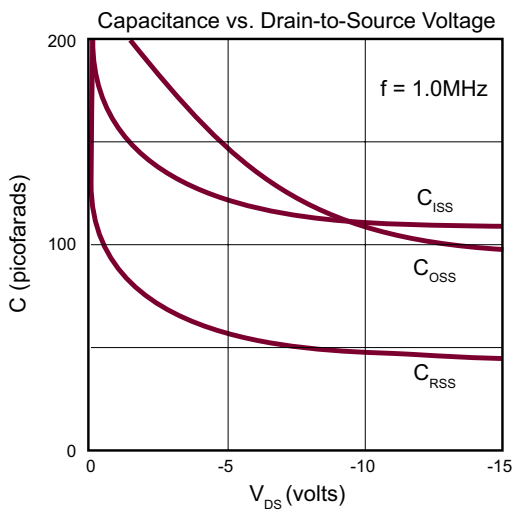
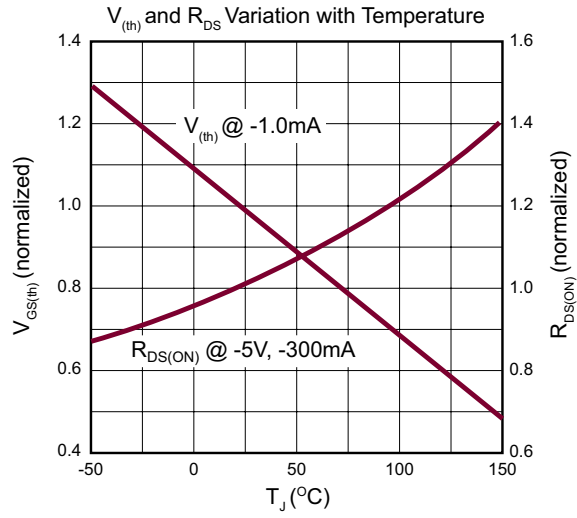
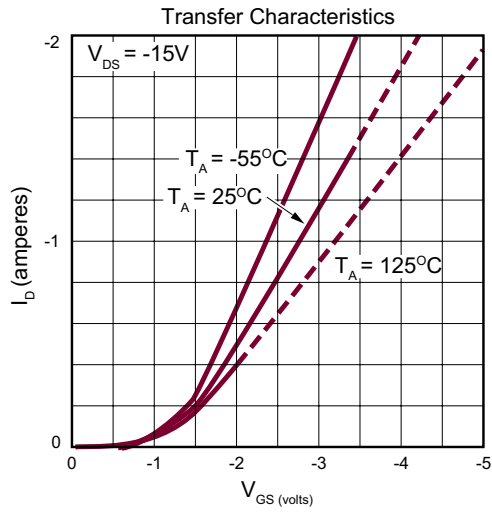
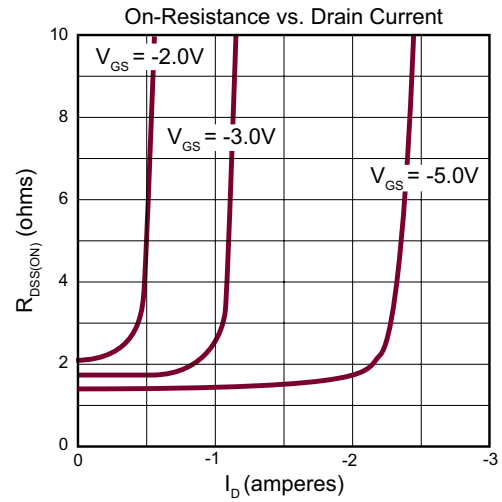
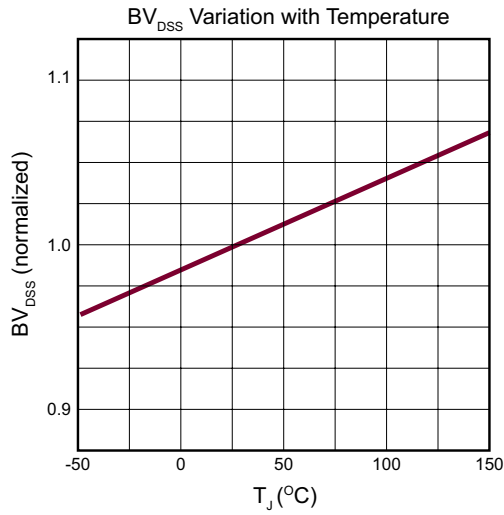

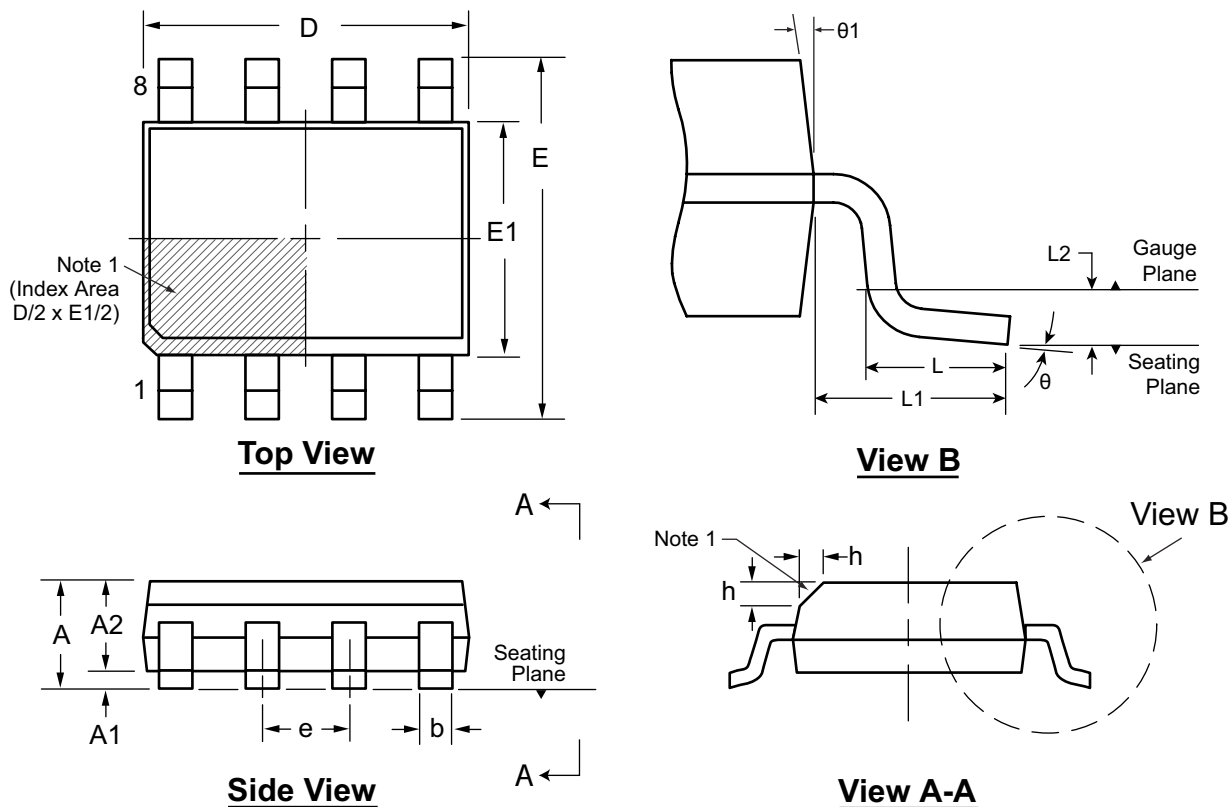

Note:
 1. This chamfer feature is optional. A Pin 1 identifier must be located in the index area indicated. The Pin 1 identifier can be: a molded mark/identifier; an embedded metal marker; or a printed indicator.

Symbol	A	A1	A2	b	D	E	E1	e	h	L	L1	L2	θ	θ_1	
Dimension (mm)	MIN	1.35*	0.10	1.25	0.31	4.80*	5.80*	3.80*	1.27 BSC	0.25	0.40	1.04 REF	0.25 BSC	0°	5°
	NOM	-	-	-	-	4.90	6.00	3.90		-	-			-	-
	MAX	1.75	0.25	1.65*	0.51	5.00*	6.20*	4.00*		0.50	1.27			8°	15°

JEDEC Registration MS-012, Variation AA, Issue E, Sept. 2005.

* This dimension is not specified in the JEDEC drawing.

Drawings are not to scale.

Supertex Doc. #: DSPD-8SOLGTG, Version I041309.

3-Lead TO-92 Package Outline (N3)

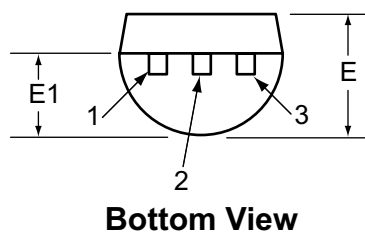
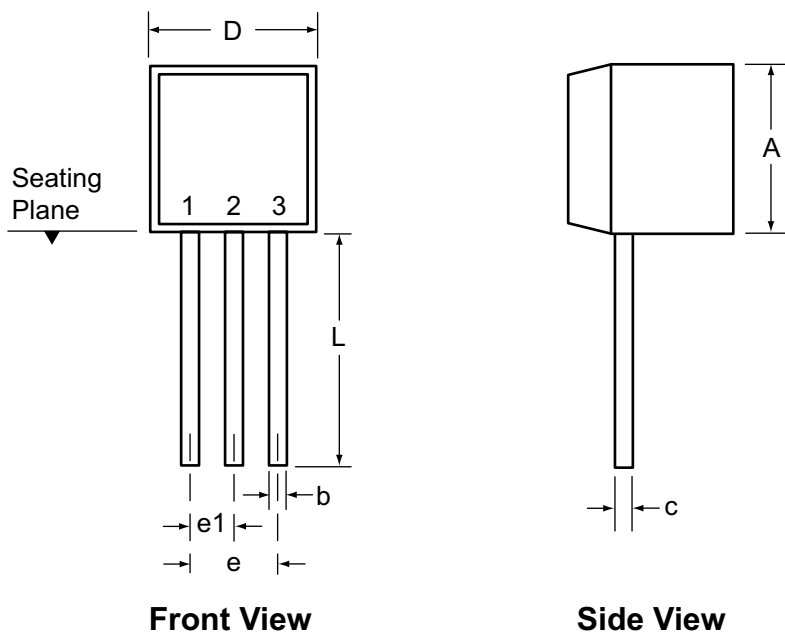

Symbol		A	b	c	D	E	E1	e	e1	L
Dimensions (inches)	MIN	.170	.014 [†]	.014 [†]	.175	.125	.080	.095	.045	.500
	NOM	-	-	-	-	-	-	-	-	-
	MAX	.210	.022 [†]	.022 [†]	.205	.165	.105	.105	.055	.610*

JEDEC Registration TO-92.

* This dimension is not specified in the JEDEC drawing.

† This dimension differs from the JEDEC drawing.

Drawings not to scale.

Supertex Doc.#: DSPD-3TO92N3, Version E041009.

(The package drawing(s) in this data sheet may not reflect the most current specifications. For the latest package outline information go to <http://www.supertex.com/packaging.html>.)

Supertex inc. does not recommend the use of its products in life support applications, and will not knowingly sell them for use in such applications unless it receives an adequate "product liability indemnification insurance agreement." **Supertex inc.** does not assume responsibility for use of devices described, and limits its liability to the replacement of the devices determined defective due to workmanship. No responsibility is assumed for possible omissions and inaccuracies. Circuitry and specifications are subject to change without notice. For the latest product specifications refer to the **Supertex inc.** (website: <http://www.supertex.com>)

Mouser Electronics

Authorized Distributor

Click to View Pricing, Inventory, Delivery & Lifecycle Information:

Microchip:

[LP0701N3-G](#) [LP0701LG-G](#) [LP0701N3P003-G](#) [LP0701N3P013](#) [LP0701N3P014](#) [LP0701N3P002](#) [LP0701N3P003](#)
[LP0701N3P014-G](#) [LP0701N3P013-G](#) [LP0701N3P002-G](#) [LP0701LG-G/TR](#) [LP0701LG](#) [LP0701N3](#) [LP0701N3-G P005](#)
[LP0701N3-G P002](#) [LP0701N3-G P013](#) [LP0701N3-G P014](#) [LP0701N3-G P003](#)