



MMBD1501 THRU MMBD1505

**High Conductance
Low Leakage Diode
350mW**

Features

- Low Leakage
- Surface Mount Package Ideally Suited for Automatic Insertion
- 150C Junction Temperature
- Lead Free Finish/Rohs Compliant ("P" Suffix designates RoHS Compliant. See ordering information)
- Halogen free available upon request by adding suffix "-HF"

Mechanical Data

- Epoxy meets UL 94 V-0 flammability rating
- Moisture Sensitivity Level 1
- Polarity: See Diagram
- Weight: 0.008 grams (approx.)

Maximum Ratings @ 25°C Unless Otherwise Specified

Characteristic	Symbol	Value	Unit
Working Inverse Voltage	V_{IV}	180	V
DC Forward Current	I_F	600	mA
Average Rectified Current	I_o	200	mA
Recurrent Peak Forward Current	i_f	700	mA
Peak Forward Surge Current @ $t=1.0s$ @ $t=1.0ms$	$i_{f(surge)}$	1.0 2.0	A
Power Dissipation	P_d	350	mW
Thermal Resistance, Junction to Ambient	$R_{\theta JA}$	357	°C/W
Operation & Storage Temp. Range	T_J, T_{STG}	-55 to +150	°C

Note: 1) These ratings are based on a max. junction temperature of 150 degrees C
2) These are steady state limits. The factory should be consulted on applications involving pulsed or low duty cycle operation

Electrical Characteristics @ 25°C Unless Otherwise Specified

Characteristic	Symbol	Min	Max	Unit	Test Cond.
Breakdown Voltage	B_V	200		V	$I_R=5.0\mu A$
Forward Voltage Drop	V_F	620	750	mV	$I_F=1.0mA$
		720	850	mV	$I_F=10mA$
		800	950	mV	$I_F=50mA$
		0.83	1.1	V	$I_F=100mA$
		0.87	1.3	V	$I_F=200mA$
		0.9	1.5	V	$I_F=300mA$
Reverse Current	I_R	-----	10 5.0	nA uA	$V_R=180V$ $V_R=180V T_A=150^\circ C$
Junction Capacitance	C_j	-----	4	pF	$V_R=0V, f=1.0MHz$

SOT-23

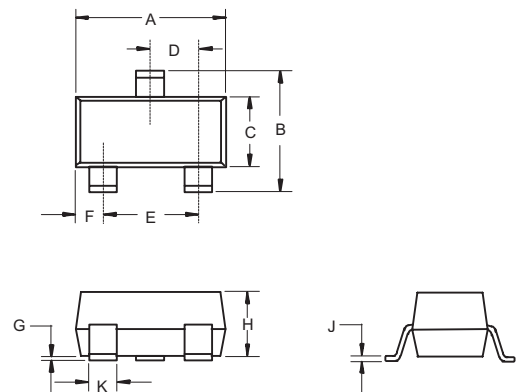

DIM	INCHES		MM		NOTE
	MIN	MAX	MIN	MAX	
A	.110	.120	2.80	3.04	
B	.083	.104	2.10	2.64	
C	.047	.055	1.20	1.40	
D	.035	.041	.89	1.03	
E	.070	.081	1.78	2.05	
F	.018	.024	.45	.60	
G	.0005	.0039	.013	.100	
H	.035	.044	.89	1.12	
J	.003	.007	.085	.180	
K	.015	.020	.37	.51	

Suggested Solder Pad Layout

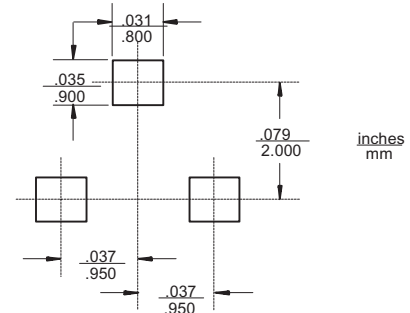

MMBD1501thru MMBD1505

REVERSE VOLTAGE vs REVERSE CURRENT
BV - 3.0 to 100 μ A

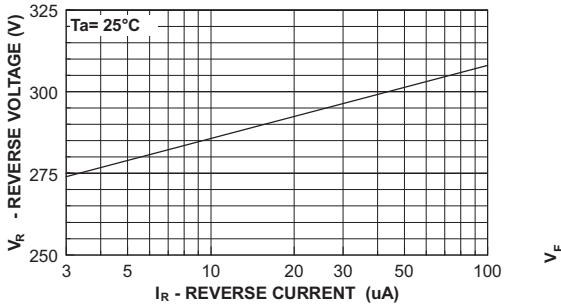

Reverse Current Vs Reverse Voltage
 I_R - 130 - 205 volts

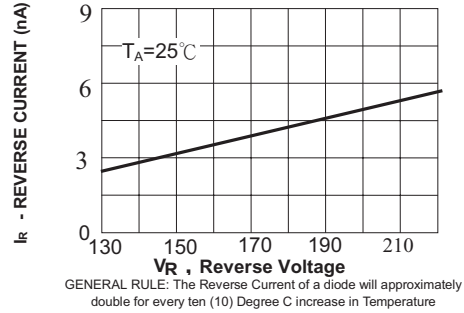

FORWARD VOLTAGE vs FORWARD CURRENT
VF - 10 to 800 mA

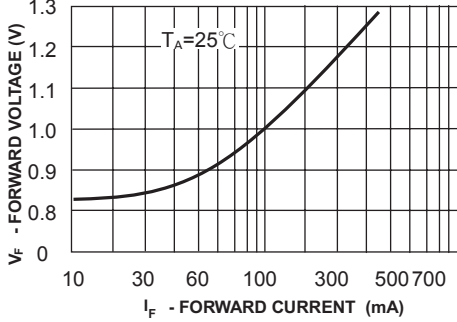

CAPACITANCE vs REVERSE VOLTAGE
VR - 0 to 15 V

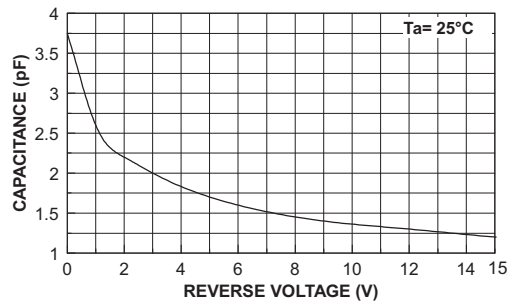

FORWARD VOLTAGE vs FORWARD CURRENT
VF - 0.1 to 10 mA

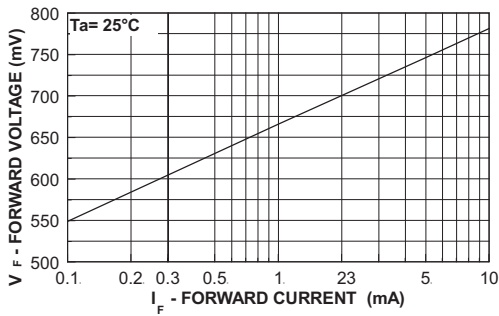

POWER DERATING CURVE

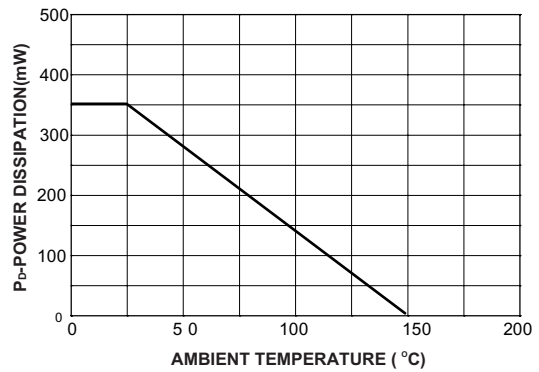

MMBD1501 thru MMBD1505

M·C·C

Micro Commercial Components

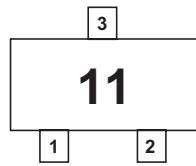

MARKING

MMBD1501	11
MMBD1503	13
MMBD1504	14
MMBD1505	15

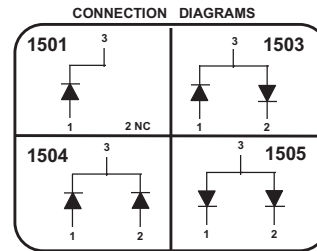



TM

Micro Commercial Components

Ordering Information :

Device	Packing
Part Number-TP	Tape&Reel: 3Kpcs/Reel

Note : Adding "-HF" suffix for halogen free, eg. Part Number-TP-HF

IMPORTANT NOTICE

Micro Commercial Components Corp. reserves the right to make changes without further notice to any product herein to make corrections, modifications , enhancements , improvements , or other changes . **Micro Commercial Components Corp .** does not assume any liability arising out of the application or use of any product described herein; neither does it convey any license under its patent rights ,nor the rights of others . The user of products in such applications shall assume all risks of such use and will agree to hold **Micro Commercial Components Corp .** and all the companies whose products are represented on our website, harmless against all damages.

LIFE SUPPORT

MCC's products are not authorized for use as critical components in life support devices or systems without the express written approval of Micro Commercial Components Corporation.

CUSTOMER AWARENESS

Counterfeiting of semiconductor parts is a growing problem in the industry. Micro Commercial Components (MCC) is taking strong measures to protect ourselves and our customers from the proliferation of counterfeit parts. MCC strongly encourages customers to purchase MCC parts either directly from MCC or from Authorized MCC Distributors who are listed by country on our web page cited below. Products customers buy either from MCC directly or from Authorized MCC Distributors are genuine parts, have full traceability, meet MCC's quality standards for handling and storage. **MCC will not provide any warranty coverage or other assistance for parts bought from Unauthorized Sources.** MCC is committed to combat this global problem and encourage our customers to do their part in stopping this practice by buying direct or from authorized distributors.

www.mccsemi.com

Mouser Electronics

Authorized Distributor

Click to View Pricing, Inventory, Delivery & Lifecycle Information:

[Micro Commercial Components \(MCC\):](#)

[MMBD1503-TP](#) [MMBD1505-TP](#) [MMBD1504-TP](#) [MMBD1501-TP](#)