

Low Input Current, Phototransistor Output, SOP-4, Mini-Flat Package

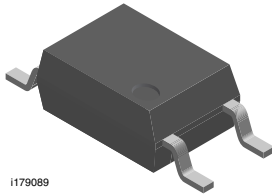

I179089

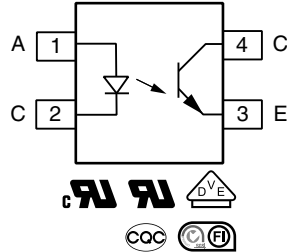

FEATURES

- Operating temperature from - 55 °C to + 110 °C
- SOP-4 mini-flat package
- CTR range 40 % to 600 %, $I_F = 1$ mA
- Isolation test voltage, 3750 V_{RMS}
- Low saturation voltage
- Fast switching times
- Low coupling capacitance
- End-stackable, 0.100" (2.54 mm) spacing
- Material categorization: For definitions of compliance please see www.vishay.com/doc?99912



DESCRIPTION

The 110 °C rated VOM618A has a GaAs infrared emitting diode emitter, which is optically coupled to a silicon planar phototransistor detector, and is incorporated in a 4 pin 100 mil lead pitch miniflat package. It features a high current transfer ratio with low input current, low coupling capacitance, and high isolation voltage.

These coupling devices are designed for signal transmission between two electrically separated circuits.

APPLICATIONS

- PLCs
- Telecommunication
- Lighting control system
- Solar inverters
- AC drives

AGENCY APPROVALS

(All parts are certified under base model VOM618A)

- UL1577, file no. E52744
- cUL tested to CSA 22.2 bulletin 5A
- DIN EN 60747-5-5 (VDE 0884-5), available with option 1
- FIMKO EN 60065 and EN 60950-1
- CQC: GB8898-2011, GB4943.1-2011

ORDERING INFORMATION

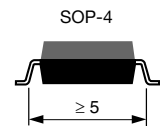
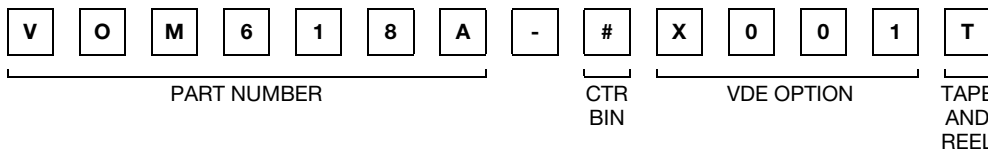

| AGENCY CERTIFIED/ PACKAGE | CTR (%) | | | | | | | | | |
|------------------------------|---------------|----------------|----------------|----------------|----------------|----------------|----------------|----------------|----------------|----------------|
| | 1 mA | | | | | | | | | |
| UL, cUL, FIMKO, CQC | 50 to 600 | 40 to 80 | 63 to 125 | 100 to 200 | 160 to 320 | 50 to 100 | 250 to 500 | 80 to 160 | 130 to 260 | 200 to 400 |
| SOP-4, mini-flat | VOM618AT | VOM618A-1T | VOM618A-2T | VOM618A-3T | VOM618A-4T | VOM618A-5T | VOM618A-6T | VOM618A-7T | VOM618A-8T | VOM618A-9T |
| VDE, UL, cUL, CQC, FIMKO | 50 to 600 | 40 to 80 | 63 to 125 | 100 to 200 | 160 to 320 | 50 to 100 | 250 to 500 | 80 to 160 | 130 to 260 | 200 to 400 |
| SOP-4, mini-flat | VOM618A-X001T | VOM618A-1X001T | VOM618A-2X001T | VOM618A-3X001T | VOM618A-4X001T | VOM618A-5X001T | VOM618A-6X001T | VOM618A-7X001T | VOM618A-8X001T | VOM618A-9X001T |

| ABSOLUTE MAXIMUM RATINGS ($T_{amb} = 25\text{ }^{\circ}\text{C}$, unless otherwise specified) | | | | |
|--|----------------------------------|------------|---------------|--------------------|
| PARAMETER | TEST CONDITION | SYMBOL | VALUE | UNIT |
| INPUT | | | | |
| DC forward current | | I_F | 60 | mA |
| Reverse voltage | | V_R | 6 | V |
| Power dissipation | | P_{diss} | 70 | mW |
| Surge forward current | $t_p \leq 10\text{ }\mu\text{s}$ | I_{FSM} | 2.5 | A |
| OUTPUT | | | | |
| Collector emitter voltage | | V_{CEO} | 80 | V |
| Emitter collector voltage | | V_{ECO} | 7 | V |
| Collector current | | I_C | 50 | mA |
| | $t_p \leq 1\text{ ms}$ | I_C | 100 | mA |
| Power dissipation | | P_{diss} | 150 | mW |
| COUPLER | | | | |
| Isolation test voltage between emitter and detector | $t = 1\text{ min}$ | V_{ISO} | 3750 | V_{RMS} |
| Total power dissipation | | P_{tot} | 170 | mW |
| Operating temperature range | | T_{amb} | - 55 to + 110 | $^{\circ}\text{C}$ |
| Storage temperature range | | T_{stg} | - 55 to + 150 | $^{\circ}\text{C}$ |
| Junction temperature | | T_j | 125 | $^{\circ}\text{C}$ |
| Soldering temperature ⁽¹⁾ | | T_{sld} | 260 | $^{\circ}\text{C}$ |

Notes

- Stresses in excess of the absolute maximum ratings can cause permanent damage to the device. Functional operation of the device is not implied at these or any other conditions in excess of those given in the operational sections of this document. Exposure to absolute maximum ratings for extended periods of the time can adversely affect reliability.

⁽¹⁾ See "Assembly Instructions" for surface mounted devices (www.vishay.com/doc?80054).

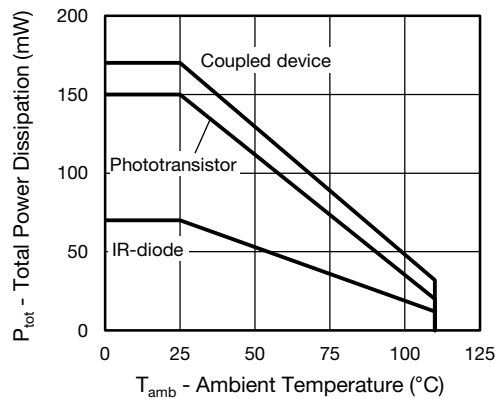

Fig. 1 - Total Power Dissipation vs. Ambient Temperature



| ELECTRICAL CHARACTERISTICS ($T_{amb} = 25\text{ }^{\circ}\text{C}$, unless otherwise specified) | | | | | | |
|--|--|-------------|------|------|------|---------------|
| PARAMETER | TEST CONDITION | SYMBOL | MIN. | TYP. | MAX. | UNIT |
| INPUT | | | | | | |
| Forward voltage | $I_F = 5\text{ mA}$ | V_F | | 1.1 | 1.6 | V |
| Reverse current | $V_R = 6\text{ V}$ | I_R | | 0.01 | 10 | μA |
| Capacitance | $V_R = 0\text{ V}, f = 1\text{ MHz}$ | C_j | | 9 | | pF |
| OUTPUT | | | | | | |
| Collector emitter leakage current | $V_{CE} = 20\text{ V}$ | I_{CEO} | | 0.4 | 100 | nA |
| Collector emitter breakdown voltage | $I_C = 100\text{ }\mu\text{A}$ | BV_{CEO} | 80 | | | V |
| Emitter collector breakdown voltage | $I_E = 10\text{ }\mu\text{A}$ | BV_{ECO} | 7 | | | V |
| Collector emitter capacitance | $V_{CE} = 5\text{ V}, f = 1\text{ MHz}$ | C_{CE} | | 2.8 | | pF |
| COUPLER | | | | | | |
| Coupling capacitance | $f = 1\text{ MHz}$ | C_C | | 0.3 | | pF |
| Collector emitter saturation voltage | $I_F = 1\text{ mA}, I_C = 0.25\text{ mA}$ | V_{CEsat} | | 0.12 | 0.4 | V |
| Cut-off frequency | $I_F = 10\text{ mA}, V_{CC} = 5\text{ V}, R_L = 100\text{ }\Omega$ | f_{ctr} | | 110 | | kHz |

Note

- Minimum and maximum values are testing requirements. Typical values are characteristics of the device and are the result of engineering evaluation. Typical values are for information only and are not part of the testing requirements.

| CURRENT TRANSFER RATIO ($T_{amb} = 25\text{ }^{\circ}\text{C}$, unless otherwise specified) | | | | | | | |
|--|--|-----------|--------|------|------|------|------|
| PARAMETER | TEST CONDITION | PART | SYMBOL | MIN. | TYP. | MAX. | UNIT |
| I_C/I_F | $I_F = 1\text{ mA}, V_{CE} = 5\text{ V}$ | VOM618A | CTR | 50 | | 600 | % |
| | | VOM618A-1 | CTR | 40 | | 80 | % |
| | | VOM618A-2 | CTR | 63 | | 125 | % |
| | | VOM618A-3 | CTR | 100 | | 200 | % |
| | | VOM618A-4 | CTR | 160 | | 320 | % |
| | | VOM618A-5 | CTR | 50 | | 100 | % |
| | | VOM618A-6 | CTR | 250 | | 500 | % |
| | | VOM618A-7 | CTR | 80 | | 160 | % |
| | | VOM618A-8 | CTR | 130 | | 260 | % |
| | | VOM618A-9 | CTR | 200 | | 400 | % |

| SWITCHING CHARACTERISTICS ($T_{amb} = 25\text{ }^{\circ}\text{C}$, unless otherwise specified) | | | | | | |
|---|--|-----------|------|------|------|---------------|
| PARAMETER | TEST CONDITION | SYMBOL | MIN. | TYP. | MAX. | UNIT |
| NON-SATURATED | | | | | | |
| Rise and fall time | $I_C = 2\text{ mA}, V_{CC} = 5\text{ V}, R_L = 100\text{ }\Omega$ | t_r | | 5 | | μs |
| Fall time | | t_f | | 4 | | μs |
| Turn-on time | | t_{on} | | 7 | | μs |
| Turn-off time | | t_{off} | | 6 | | μs |
| SATURATED | | | | | | |
| Rise and fall time | $I_F = 1.6\text{ mA}, V_{CC} = 5\text{ V}, R_L = 4.7\text{ k}\Omega$ | t_r | | 6 | | μs |
| Fall time | | t_f | | 29 | | μs |
| Turn-on time | | t_{on} | | 8 | | μs |
| Turn-off time | | t_{off} | | 35 | | μs |

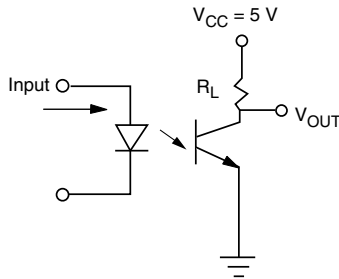

Fig. 2 - Test Circuit

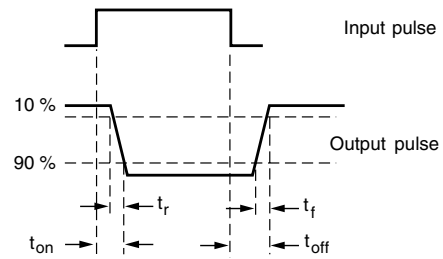

Fig. 3 - Test Circuit and Waveforms

| SAFETY AND INSULATION RATINGS | | | |
|--|--|----------|-------------------------|
| PARAMETER | SYMBOL | VALUE | UNIT |
| MAXIMUM SAFETY RATINGS | | | |
| Output safety power | P_{SO} | 300 | mW |
| Input safety current | I_{si} | 200 | mW |
| Safety temperature | T_S | 150 | °C |
| Comparative tracking index | CTI | 175 | |
| INSULATION RATED PARAMETERS | | | |
| Maximum withstanding isolation voltage | V_{ISO} | 3750 | V_{RMS} |
| Maximum transient isolation voltage | V_{IOTM} | 6000 | V_{peak} |
| Maximum repetitive peak isolation voltage | V_{IORM} | 565 | V_{peak} |
| Insulation resistance | $T_{amb} = 25\text{ °C}, V_{DC} = 500\text{ V}$ | R_{IO} | $10^{12}\text{ }\Omega$ |
| Insulation resistance | $T_{amb} = 100\text{ °C}, V_{DC} = 500\text{ V}$ | R_{IO} | $10^{11}\text{ }\Omega$ |
| Climatic classification (according to IEC 68 part 1) | | | 55/110/21 |
| Environment (pollution degree in accordance to DIN VDE 0109) | | | 2 |
| Internal creepage | | | ≥ 5 mm |
| External creepage | | | ≥ 5 mm |
| Clearance | | | ≥ 5 mm |
| Insulation thickness | | | ≥ 0.4 mm |

Note

- As per DIN EN 60747-5-5 (VDE 0884), § 7.4.3.8.2, this optocoupler is suitable for "safe electrical insulation" only within the safety ratings. Compliance with the safety ratings shall be ensured by means of protective circuits.

TYPICAL CHARACTERISTICS ($T_{amb} = 25\text{ °C}$, unless otherwise specified)

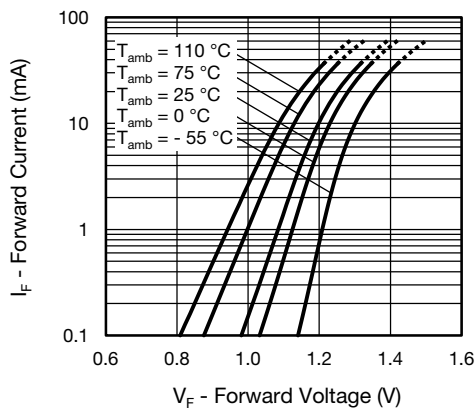

Fig. 4 - Forward Voltage vs. Forward Current

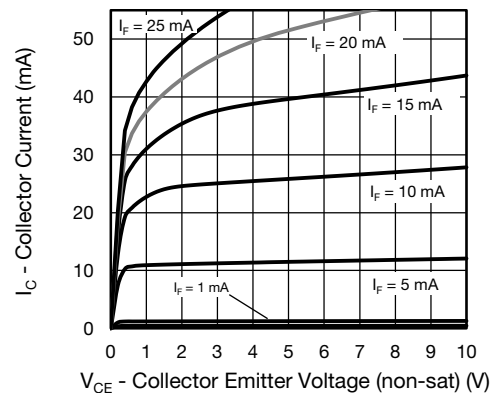

Fig. 5 - Collector Current vs. Collector Emitter Voltage (non-saturated)

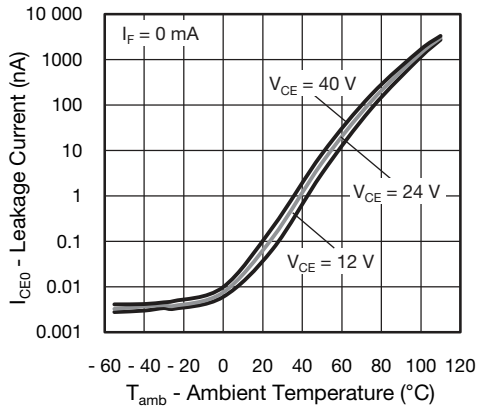

Fig. 6 - Collector Emitter Current vs. Ambient Temperature

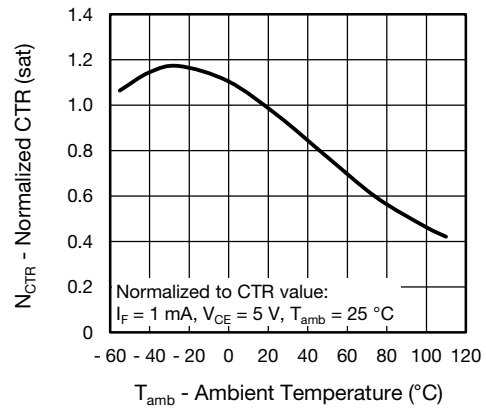

Fig. 9 - Normalized Current Transfer Ratio vs. Ambient Temperature (saturated)

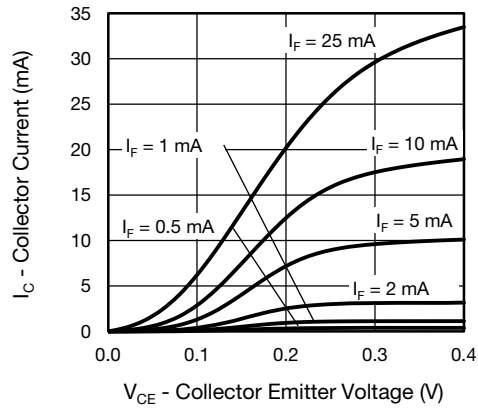

Fig. 7 - Collector Current vs. Collector Emitter Voltage (saturated)

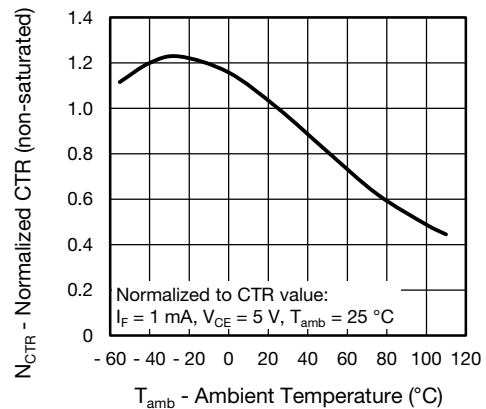

Fig. 10 - Normalized Current Transfer Ratio vs. Ambient Temperature (non-saturated)

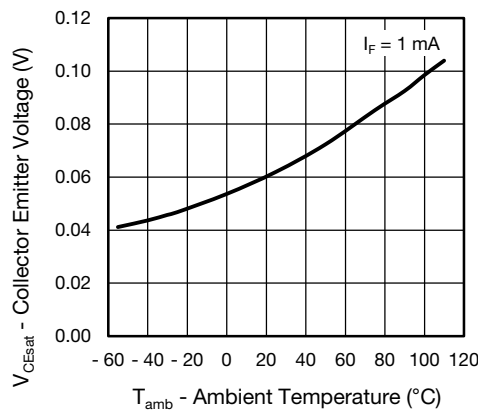

Fig. 8 - Collector Emitter Voltage vs. Ambient Temperature (saturated)

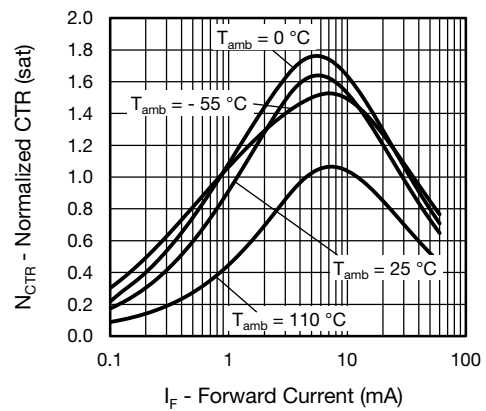

Fig. 11 - Current Transfer Ratio vs. Forward Current (saturated) normalized to 1 mA at 25 °C

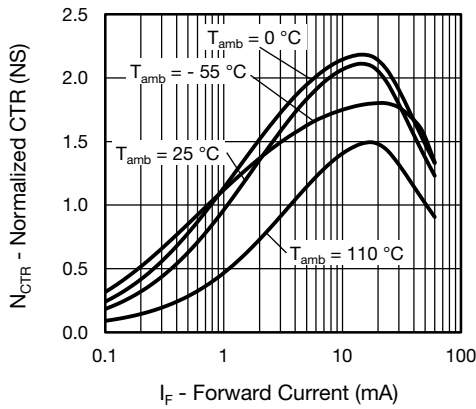

Fig. 12 - Current Transfer Ratio vs. Forward Current (non-saturated) normalized to 1 mA at 25 °C

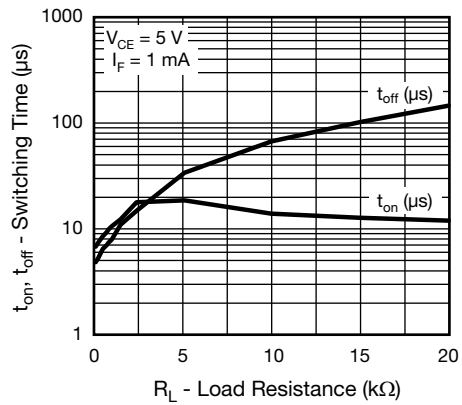

Fig. 15 - Switching Time vs. Load Resistance

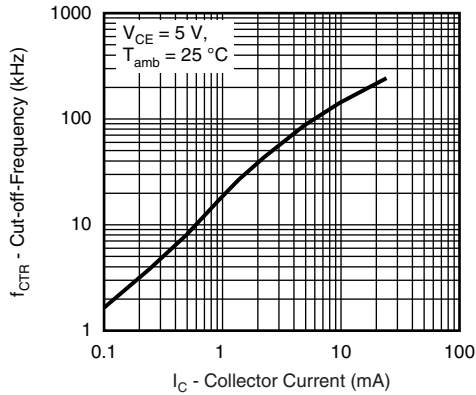

Fig. 13 - Cut-off Frequency (- 3 dB) vs. Collector Current

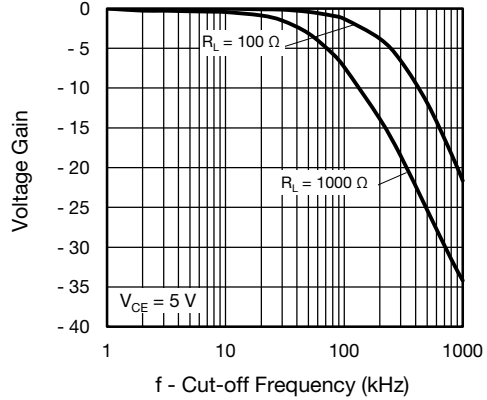

Fig. 16 - Voltage Gain vs. Cut-off Frequency

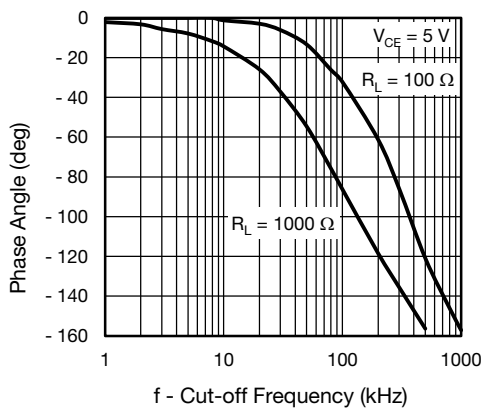
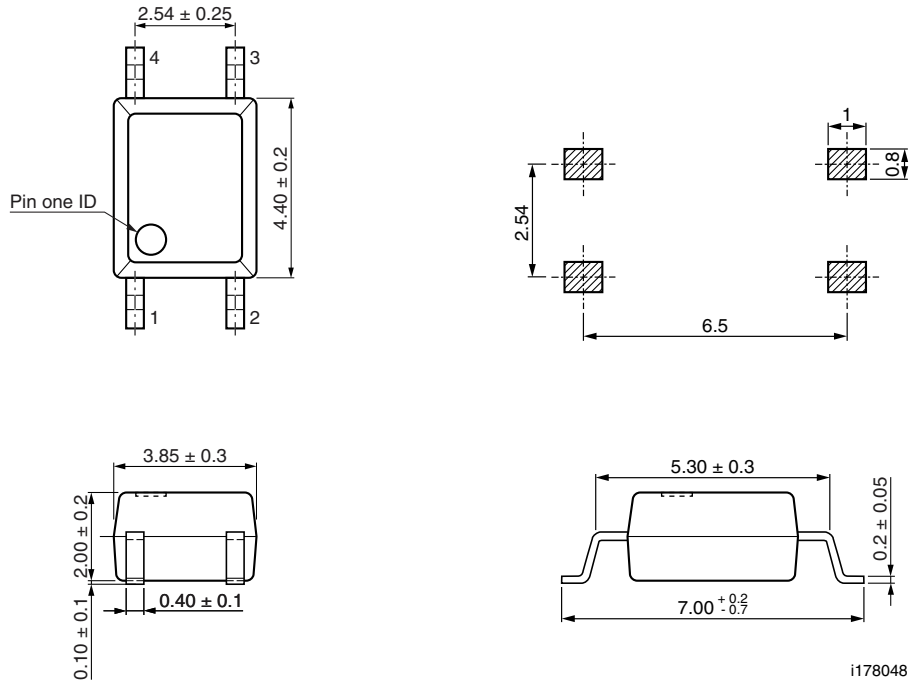

Fig. 14 - F_{CTR} vs. Phase Angle

PACKAGE DIMENSIONS in millimeters



i178048

PACKAGE MARKING (example of VOM618A-3X001T)

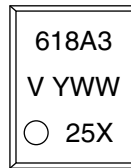

Notes

- Only option 1 is reflected in the package marking with the character "X".
- Tape and reel suffix (T) is not part of the package marking.

TAPE AND REEL DIMENSIONS in millimeters

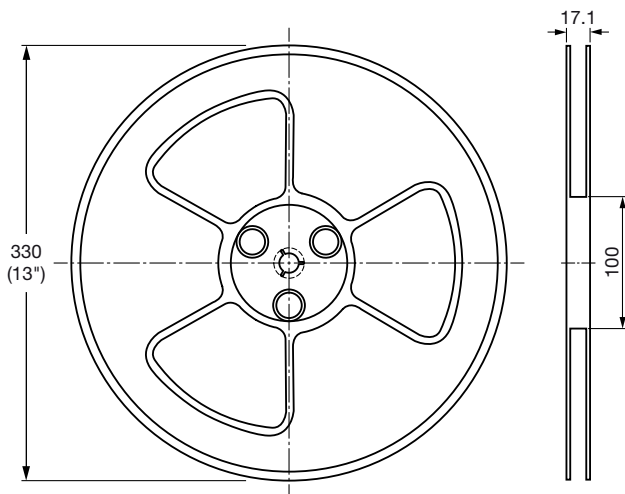

Fig. 17 - Reel Dimensions (3000 units per reel)

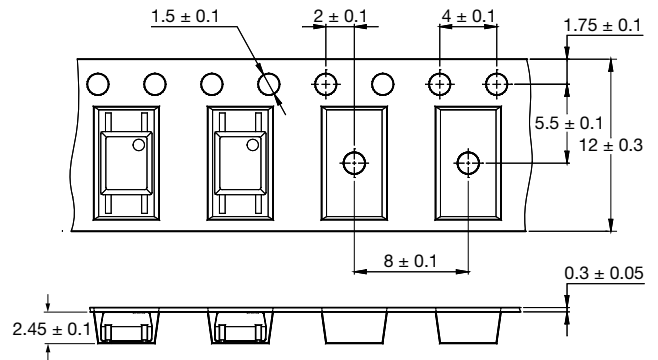

Fig. 18 - Tape Dimensions



Disclaimer

ALL PRODUCT, PRODUCT SPECIFICATIONS AND DATA ARE SUBJECT TO CHANGE WITHOUT NOTICE TO IMPROVE RELIABILITY, FUNCTION OR DESIGN OR OTHERWISE.

Vishay Intertechnology, Inc., its affiliates, agents, and employees, and all persons acting on its or their behalf (collectively, "Vishay"), disclaim any and all liability for any errors, inaccuracies or incompleteness contained in any datasheet or in any other disclosure relating to any product.

Vishay makes no warranty, representation or guarantee regarding the suitability of the products for any particular purpose or the continuing production of any product. To the maximum extent permitted by applicable law, Vishay disclaims (i) any and all liability arising out of the application or use of any product, (ii) any and all liability, including without limitation special, consequential or incidental damages, and (iii) any and all implied warranties, including warranties of fitness for particular purpose, non-infringement and merchantability.

Statements regarding the suitability of products for certain types of applications are based on Vishay's knowledge of typical requirements that are often placed on Vishay products in generic applications. Such statements are not binding statements about the suitability of products for a particular application. It is the customer's responsibility to validate that a particular product with the properties described in the product specification is suitable for use in a particular application. Parameters provided in datasheets and / or specifications may vary in different applications and performance may vary over time. All operating parameters, including typical parameters, must be validated for each customer application by the customer's technical experts. Product specifications do not expand or otherwise modify Vishay's terms and conditions of purchase, including but not limited to the warranty expressed therein.

Hyperlinks included in this datasheet may direct users to third-party websites. These links are provided as a convenience and for informational purposes only. Inclusion of these hyperlinks does not constitute an endorsement or an approval by Vishay of any of the products, services or opinions of the corporation, organization or individual associated with the third-party website. Vishay disclaims any and all liability and bears no responsibility for the accuracy, legality or content of the third-party website or for that of subsequent links.

Except as expressly indicated in writing, Vishay products are not designed for use in medical, life-saving, or life-sustaining applications or for any other application in which the failure of the Vishay product could result in personal injury or death. Customers using or selling Vishay products not expressly indicated for use in such applications do so at their own risk. Please contact authorized Vishay personnel to obtain written terms and conditions regarding products designed for such applications.

No license, express or implied, by estoppel or otherwise, to any intellectual property rights is granted by this document or by any conduct of Vishay. Product names and markings noted herein may be trademarks of their respective owners.