



TS4982

2 W stereo audio power amplifier with ground-referenced headphone driver

Features

- 2 W output power into 4 Ω load per channel
- 125 mW into 16 Ω load ground-referenced stereo headphone driver
- Four-step gain settings on speaker path
- 3 levels of 3D effect on speaker path
- PC-beep input system detection
- ± 8 kV HBM ESD-protected headphone outputs
- Pop and click reduction circuitry
- 32-pin 5 x 5 mm QFN package
- Thermal shutdown and output short-circuit protection^(a)

Applications

- Laptop/notebook computers
- Portable audio devices

Description

The TS4982 features a stereo loudspeaker driver and a ground-referenced stereo headphone driver. An independent standby mode pin allows the TS4982 to simultaneously drive both output drivers. Operating on a single 5 V supply, the TS4982 delivers 2 W (typ.) output power into a 4 Ω load at 1% THD+N.

The TS4982 features a PC beep input, three levels of 3D stereo enhancement and 4-step gain control using two digital input pins. Minimum external components make the TS4982 well-suited for notebook and other hand-held sound equipment. It also has an internal thermal shutdown (150° C) and output short circuit protection mechanism.

a. Patented US#: 2009/0102561, EP#: 1978636

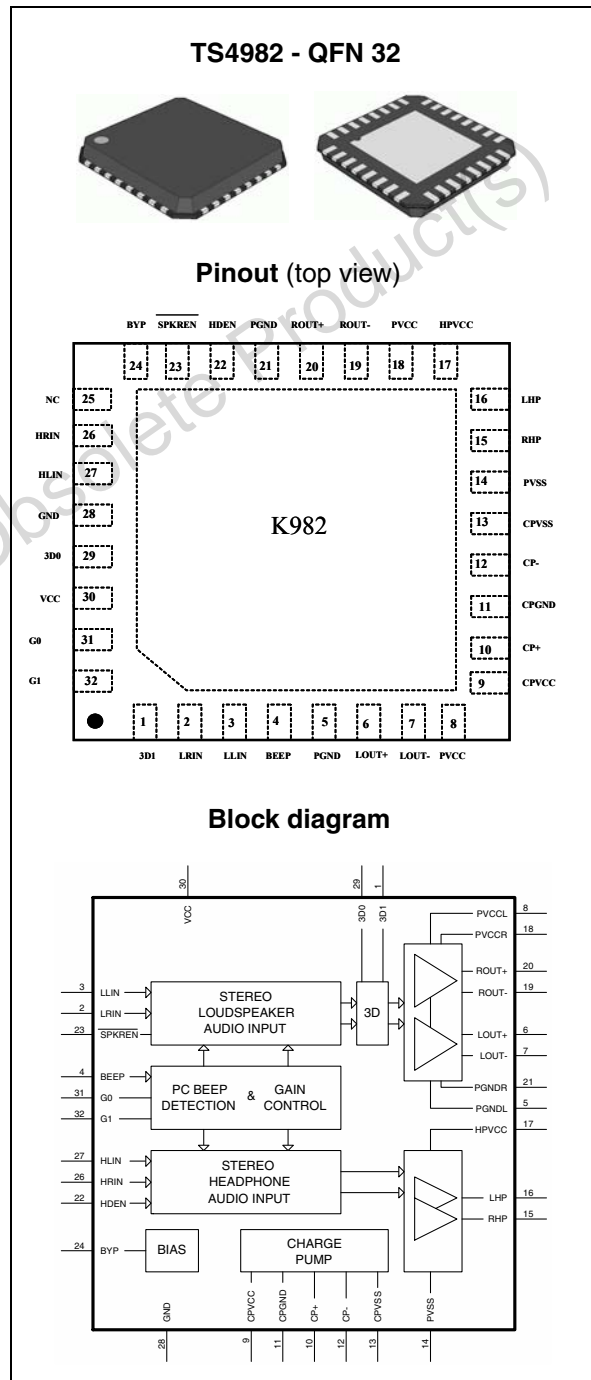

Contents

- 1 Absolute maximum ratings and operating conditions 3**
- 2 Typical application 5**
- 3 Electrical characteristics 7**
 - 3.1 Electrical characteristics tables 7
 - 3.2 Electrical characteristic curves 9
- 4 Application information 16**
 - 4.1 General description 16
 - 4.2 Loudspeaker BTL configuration principle 16
 - 4.3 Power dissipation and efficiency 17
 - 4.4 Loudspeaker 3D effect enhancement 19
 - 4.5 Low frequency response 19
 - 4.6 Gain settings 20
 - 4.7 PC beep 21
 - 4.8 Decoupling and charge pump capacitors 22
 - 4.8.1 Decoupling capacitors Cs and Cb 22
 - 4.8.2 Charge pump capacitors Cp and Cps 23
 - 4.9 Wake-up time 23
 - 4.10 Standby time 24
 - 4.11 Pop & click 24
 - 4.12 Headphone jack detection 24
 - 4.13 PCB layout recommendations 25
- 5 Package information 26**
 - 5.1 QFN32 package information 27
- 6 Ordering information 29**
- 7 Revision history 30**

1 Absolute maximum ratings and operating conditions

Table 1. Absolute maximum ratings

Symbol	Parameter	Value	Unit
V_{CC} PV_{CCL} PV_{CCR} HPV_{CC} CPV_{CC}	Supply voltage ⁽¹⁾	6	V
V_{in}	Input voltage Loudspeaker inputs Headphone inputs $V_{HDEN} = V_{IH}$ $V_{HDEN} = V_{IL}$	-0.3 to $V_{CC} + 0.3$ -3 to 3 -0.3 to $V_{CC} + 0.3$	V
T_{oper}	Operating free-air temperature range	-40 to +85	°C
T_{stg}	Storage temperature	-65 to +150	°C
T_j	Maximum junction temperature	150	°C
R_{thja}	Thermal resistance junction to ambient ⁽²⁾	80	°C/W
P_d	Power dissipation	Internally limited ⁽³⁾	
ESD	HBM: human body model All pins except headphone outputs ⁽⁴⁾ Headphone output pins (LHP, RHP) ⁽⁵⁾	2 8	kV
	MM: machine model ⁽⁶⁾	200	V
	CDM: charged device model ⁽⁷⁾	1500	V
Latch-up	Latch-up immunity	200	mA
	Lead temperature (soldering, 10 sec)	260	°C

- All voltage values are measured with respect to the ground pin.
- Device is protected in case of over-temperature by a thermal shutdown active at 150° C.
- Exceeding the power derating curves during a long period can cause abnormal operation.
- Human body model: a 100 pF capacitor is charged to the specified voltage, then discharged through a 1.5 kΩ resistor between two pins of the device. This is done for all couples of connected pin combinations while the other pins are floating.
- Human body model: a 100 pF capacitor is charged to the specified voltage, then discharged through a 1.5 kΩ resistor between two pins of the device. This is done between headphone output pins, between headphone output pins and V_{CC} , GND. The other pins are floating.
- Machine model: a 200 pF capacitor is charged to the specified voltage, then discharged directly between two pins of the device with no external series resistor (internal resistor < 5 Ω). This is done for all couples of connected pin combinations while the other pins are floating.
- Charged device model: all pins and package are charged together to the specified voltage and then discharged directly to ground through only one pin.

Table 2. Operating conditions

Symbol	Parameter	Value	Unit
V _{CC} PV _{CCL} PV _{CCR}	Common power supply voltage ⁽¹⁾ Left channel loudspeaker amplifier power supply Right channel loudspeaker amplifier power supply	4.5 to 5.5	V
HPV _{CC} CPV _{CC}	Headphone supply voltage ⁽²⁾ Negative charge pump supply voltage	3 to V _{CC}	V
R _L	Load resistor Speaker output Headphone output	≥ 4 ≥ 16	Ω
T _{oper}	Operating free-air temperature range	-40 to +85	°C
V _{IH}	High-level input voltage 3D0, 3D1, G0, G1, HDEN, SPKREN pin ⁽³⁾	2.0 ≤ V _{IH} ≤ V _{CC}	V
V _{IL}	Low-level input voltage 3D0, 3D1, G0, G1, HDEN, SPKREN pin ⁽³⁾	GND ≤ V _{IL} ≤ 0.8	V
R _{thja}	Thermal resistance junction to ambient ⁽⁴⁾	25	°C/W

1. V_{CC}, PV_{CCL} and PV_{CCR} must be shorted or at the same voltage.
2. HPV_{CC} and CPV_{CC} must be shorted or at the same voltage.
3. Any digital pins (3D0, 3D1, G0, G1, SPKREN, HDEN) must not be left floating.
4. With 4-layer PCB.

Table 3. Operating modes

SPKREN	HDEN	V _{SPKREN}	V _{HDEN}	Speaker amplifier	Headphone amplifier
0	0	V _{IL}	V _{IL}	ENABLED	DISABLED (standby)
0	1	V _{IL}	V _{IH}	ENABLED	ENABLED
1	0	V _{IH}	V _{IL}	DISABLED (standby)	DISABLED (standby)
1	1	V _{IH}	V _{IH}	DISABLED (standby)	ENABLED

2 Typical application

Figure 1. Typical application schematics

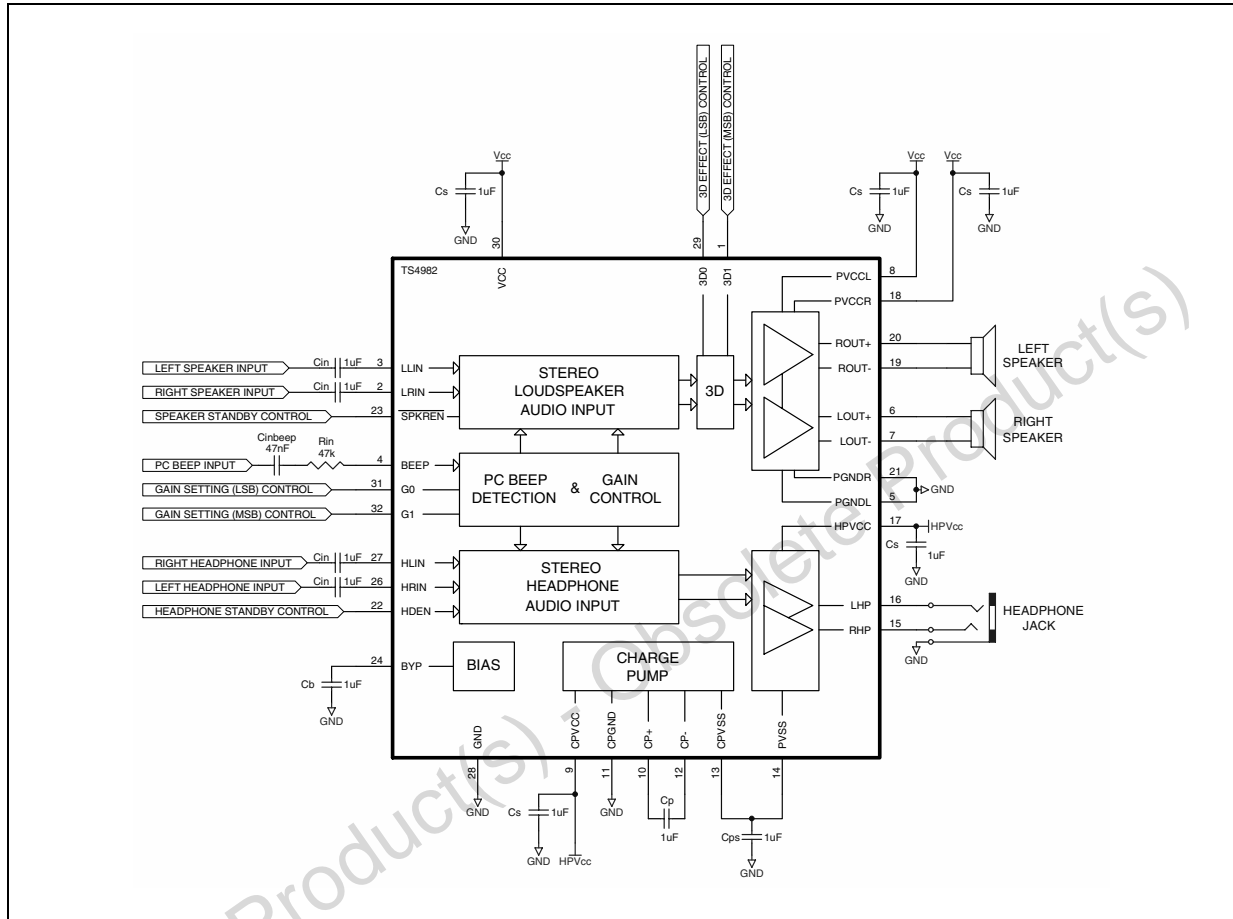

Table 4. External component description

Components	Value	Functional description
Cs, Cps	1μF	Supply decoupling capacitor that provides power supply filtering.
Cb	1μF	Bypass decoupling capacitor that provides half-supply filtering.
Cin	1μF	Input coupling capacitors that block the DC voltage at the amplifier input terminal. The capacitors also form a high-pass filter with Zin.
Cinbeep	47nF	Input coupling capacitors that block the DC voltage at the PCBEEP input terminal. The capacitors also form a high-pass filter with Rin.
Rin	47kΩ	Inverting input resistor for PCBEEP input. Together with the internal 47 kΩ feedback resistor the PC beep input gain can be adjusted to change a voltage detection level.
Cp	1μF	Flying capacitor for the negative charge pump.

Table 5. Pin descriptions

Pin number	Pin name	I/O/P ⁽¹⁾	Pin description
1	3D1	I	3D effect MSB input pin
2	LRIN	I	Right channel loudspeaker amplifier input
3	LLIN	I	Left channel loudspeaker amplifier input
4	BEEP	I	PC BEEP input
5	PGND	P	Loudspeaker amplifier power ground
6	LOUT+	O	Left channel loudspeaker positive output
7	LOUT-	O	Left channel loudspeaker negative output
8	PVCC	P	Loudspeaker amplifier power supply
9	CPVCC	P	Charge pump power supply
10	CP+	I/O	Charge pump flying capacitor positive pin
11	CPGND	P	Charge pump ground
12	CP-	I/O	Charge pump flying capacitor negative pin
13	CPVSS	P	Charge pump output, must be shorted to PVSS
14	PVSS	P	Headphone amplifier negative power supply, must be shorted to CPVSS, no external supply allowed
15	RHP	O	Right channel headphone output
16	LHP	O	Left channel headphone output
17	HPVCC	P	Headphone amplifier positive power supply
18	PVCC	P	Loudspeaker amplifier power supply
19	ROUT-	O	Right channel loudspeaker negative output
20	ROUT+	O	Left channel loudspeaker positive output
21	PGND	P	Loudspeaker amplifier power ground
22	HDEN	I	Headphone standby input pin
23	SPKREN	I	Loudspeaker standby input pin,
24	BYP	I	Common mode bias voltage
25	NC		Not internally connected
26	HRIN	I	Right channel headphone amplifier input
27	HLIN	I	Left channel headphone amplifier input
28 ⁽²⁾	GND	P	Device ground
29	3D0	I	3D effect LSB input pin
30	VCC	P	Common power supply
31	G0	I	Gain control LSB input pin
32	G1	I	Gain control MSB input pin
EXPAD		P	Thermal pad to be soldered to the ground plane of the PCB

1. I - input, O - output, P - passive or power.
2. All GNDs are internally-connected together.

3 Electrical characteristics

3.1 Electrical characteristics tables

Table 6. General electrical characteristics, $V_{CC} = PV_{CC} = HPV_{CC} = CPV_{CC} = 5V$, $T_{amb} = 25^{\circ}C$ (unless otherwise specified)

Symbol	Parameter	Min.	Typ.	Max.	Unit
I_{CC}	Current consumption, no load Speaker mode, $V_{SPKREN} = V_{HDEN} = GND$ Headphone mode, $V_{SPKREN} = V_{HDEN} = V_{CC}$		8 6	12 10	mA
I_{STBY}	Standby current consumption, no input signal $V_{HDEN} = GND$, $V_{SPKREN} = V_{CC}$,		1	5	μA
I_{in}	Level input current G0, G1, 3D0, 3D1, SPKREN, HDEN pins			1	μA
Z_{in}	Input impedance	24	30	36	k Ω

Table 7. Loudspeaker amplifier, $V_{CC} = PV_{CCL,R} = 5V$, $V_{HDEN} = V_{SPKREN} = GND$, $C_b = C_{in} = C_s = 1 \mu F$, $V_{3D0} = V_{3D1} = GND$, gain = 9 dB, $T_{amb} = 25^{\circ}C$ (unless otherwise specified)

Symbol	Parameter	Min.	Typ.	Max.	Unit
P_O	Output power THD+N = 1%, $R_L = 4 \Omega$, $f = 1 kHz$		2		W
THD + N	Total harmonic distortion plus noise, $P_O = 1.5 W$, $R_L = 4 \Omega$, $20 Hz \leq f \leq 20 kHz$, BW = 22 Hz to 22 kHz		0.08 -62		% dB
V_{oo}	Differential output offset voltage, no load, inputs AC grounded, gain = 13.5 dB, $V_{3D0} = V_{3D1} = V_{CC}$	-35		35	mV
Gain	Gain $G_0 = G_1 = V_{IL}$ $G_0 = V_{IH}$, $G_1 = V_{IL}$ $G_0 = V_{IL}$, $G_1 = V_{IH}$ $G_0 = G_1 = V_{IH}$		9 10.5 12 13.5		dB
G_{err}	Gain error		0.5		dB
PSRR	Speaker power supply rejection ratio ⁽¹⁾ $R_L = 4 \Omega$, $V_{ripple} = 200 mV_{pp}$, $F = 1 kHz$		-75		dB
X_T	Channel crosstalk $P_O = 1.5 W$, $R_L = 4 \Omega$, $20 Hz \leq f \leq 20 kHz$		-85		dB
V_n	Output noise voltage, A-weighted filter, $R_L = 4 \Omega$ Gain = 9 dB, $V_{3D0} = V_{3D1} = GND$ Gain = 13.5 dB, $V_{3D0} = V_{3D1} = V_{CC}$		17 87		μV_{rms}
SNR	Signal to noise ratio, A-weighted filter, $R_L = 4 \Omega$ $P_O = 2 W$, THD+N = 1%, $F = 1 kHz$		103		dB

Table 7. Loudspeaker amplifier, $V_{CC} = PV_{CCL,R} = 5\text{ V}$, $V_{HDEN} = V_{SPKREN} = \text{GND}$, $C_b = C_{in} = C_s = 1\ \mu\text{F}$, $V_{3D0} = V_{3D1} = \text{GND}$, gain = 9 dB, $T_{amb} = 25^\circ\text{C}$ (unless otherwise specified) (continued)

Symbol	Parameter	Min.	Typ.	Max.	Unit
C_L	Capacitive load $R_L = 4\ \Omega$ to $100\ \Omega$ $R_L > 100\ \Omega$			400 100	pF
t_{WU}	Wake up time		6	10	ms
t_{STBY}	Standby time			200	μs

1. Dynamic selective measurements - $20 \cdot \log(\text{rms}(V_{out})/\text{rms}(V_{ripple}))$. V_{ripple} is an added sinus signal to V_{CC} and $PV_{CCL,R}$.

Table 8. Headphone amplifier, $V_{CC} = PV_{CCL,R} = HPV_{CC} = CPV_{CC} = 5\text{ V}$, $V_{HDEN} = V_{SPKREN} = V_{CC}$, $C_b = C_{in} = C_s = C_p = C_{ps} = 1\ \mu\text{F}$, $V_{3D0} = V_{3D1} = \text{GND}$, $A_V = 3.5\text{ dB}$, $T_{amb} = 25^\circ\text{C}$ (unless otherwise specified)

Symbol	Parameter	Min.	Typ.	Max.	Unit
P_O	Output power, THD+N = 1%, $R_L = 16\ \Omega$, $F = 1\text{ kHz}$, $HPV_{CC} = CPV_{CC} = 5\text{ V}$ $HPV_{CC} = CPV_{CC} = 3\text{ V}$	100 35	125 65		mW
THD+N	Total harmonic distortion plus noise $P_O = 100\text{ mW}$, $R_L = 16\ \Omega$, $20\text{ Hz} \leq F \leq 20\text{ kHz}$, $BW = 22\text{ Hz}$ to 22 kHz		0.05 -66		% dB
V_{oo}	Output offset voltage, inputs AC grounded, no load	-10	0	10	mV
Gain	Gain		3.5		dB
G_{ERR}	Gain error		0.5		dB
PSRR	Power supply rejection ratio ⁽¹⁾ $R_L = 16\ \Omega$, $V_{ripple} = 200\text{ mV}_{pp}$, $F = 1\text{ kHz}$		-75		dB
X_T	Channel crosstalk $P_O = 100\text{ mW}$, $R_L = 16\ \Omega$, $20\text{ Hz} \leq F \leq 20\text{ kHz}$		-75		dB
V_n	Output noise voltage, A-weighted filter, $R_L = 16\ \Omega$ $HPV_{CC} = CPV_{CC} = 5\text{ V}$ $HPV_{CC} = CPV_{CC} = 3\text{ V}$		10 10		μV_{rms}
SNR	Signal-to-noise ratio $P_O = 125\text{ mW}$, $R_L = 16\ \Omega$, A-weighted filter		102		dB
C_L	Capacitive load $R_L = 16\ \Omega$ to $100\ \Omega$ $R_L > 100\ \Omega$			400 100	pF
t_{WU}	Wake-up time		6	10	ms
t_{STBY}	Standby time			200	μs

1. Dynamic selective measurements - $20 \cdot \log(\text{rms}(V_{out})/\text{rms}(V_{ripple}))$. V_{ripple} is an added sinus signal to HPV_{CC} and CPV_{CC} .

Table 9. Internal charge pump stage

Symbol	Parameter	Min.	Typ.	Max.	Unit
f_{osc}	Internal frequency of charge pump across temperature range	400	550	800	kHz

Table 10. PC beep input stage, $R_{IN} = 47\text{ k}\Omega$, $C_{IN} = 47\text{ nF}$

Symbol	Parameter	Min.	Typ.	Max.	Unit
V_{beep}	Beep signal minimum amplitude	0.8			V_{pp}
f_{beep}	Beep signal minimum frequency	400			Hz

3.2 Electrical characteristic curves

Table 11. Index of graphics

Description	Figure
Current consumption vs. power supply voltage	2
Current consumption vs. standby voltage	3, 4
Power derating curves	5
Speaker output power vs. power supply	6, 7
Headphone output power vs. power supply	8, 9
Speaker output power vs. load resistance	10
Headphone output power vs. load resistance	11
THD+N vs. output power	12 - 19
THD+N vs. frequency	20 - 23
PSRR vs. frequency	24, 25
Wake-up and standby time	26 - 29
Crosstalk vs. frequency	30 - 33
Channel isolation vs frequency	34
Total power dissipation vs. output power	35 - 37

Figure 2. Current consumption vs. power supply voltage

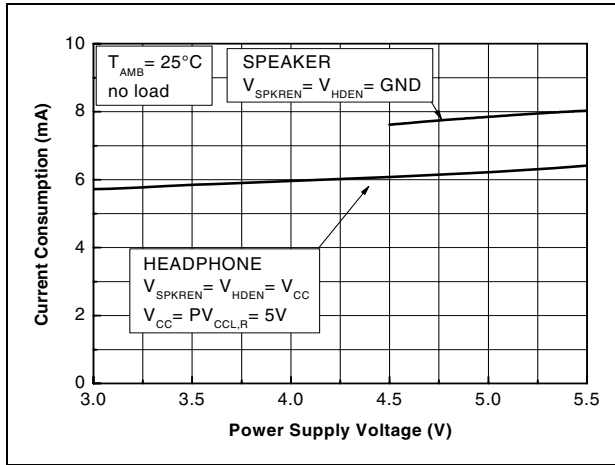

Figure 3. Current consumption vs. standby voltage

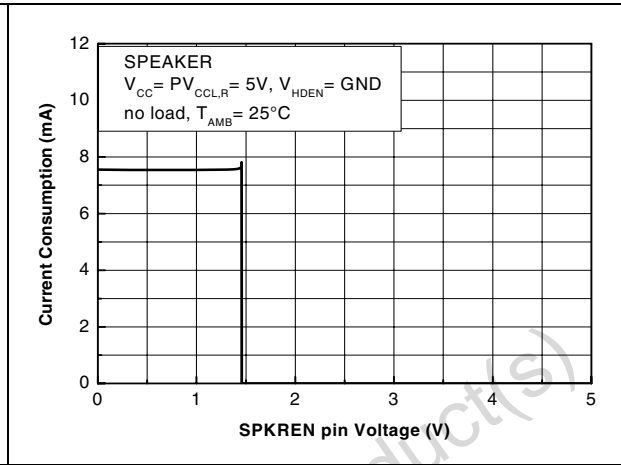

Figure 4. Current consumption vs. standby voltage

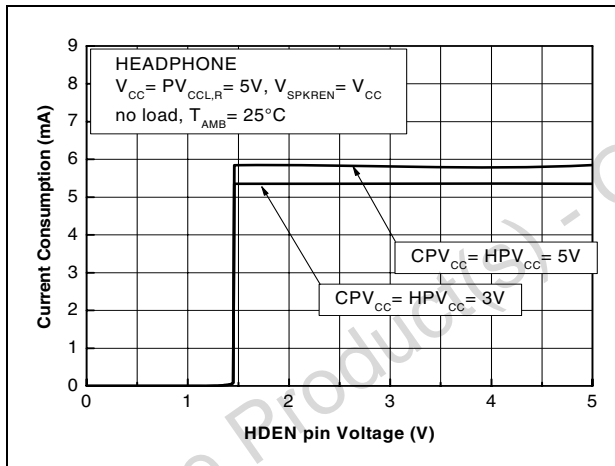

Figure 5. Power derating curves

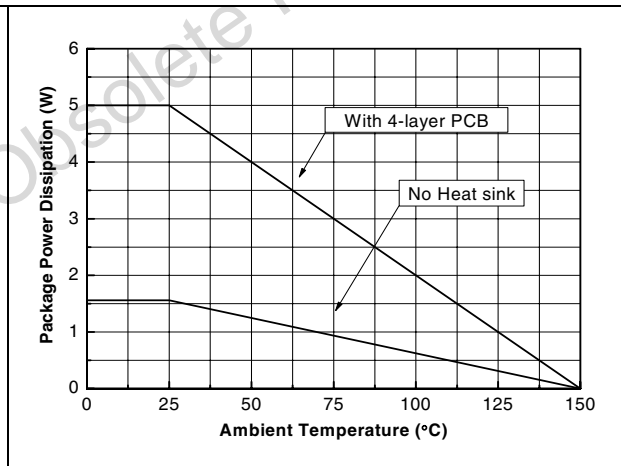

Figure 6. Output power vs. power supply

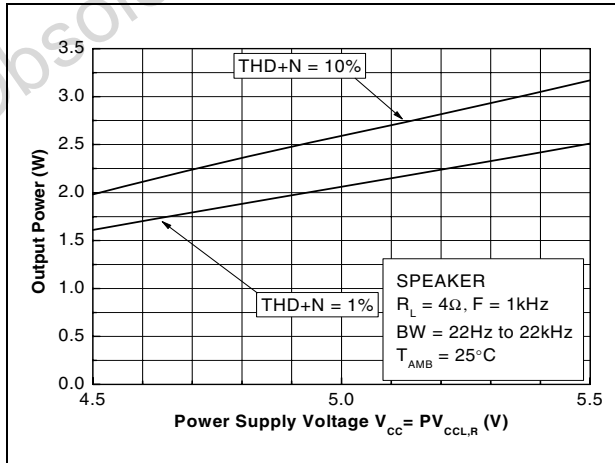

Figure 7. Output power vs. power supply

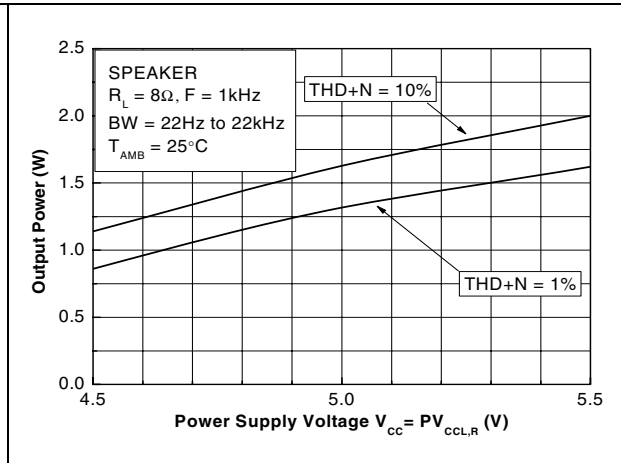

Figure 8. Output power vs. power supply

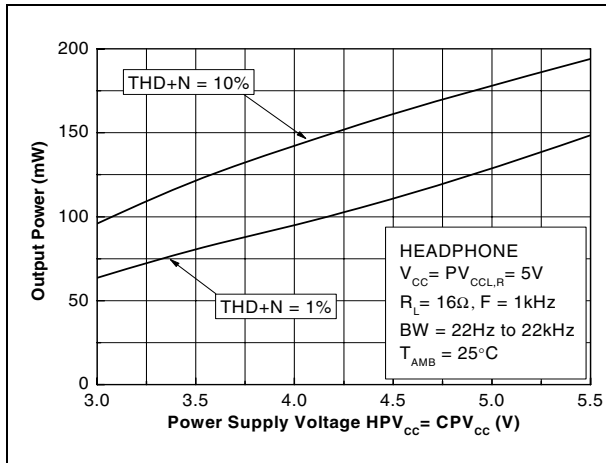

Figure 9. Output power vs. power supply

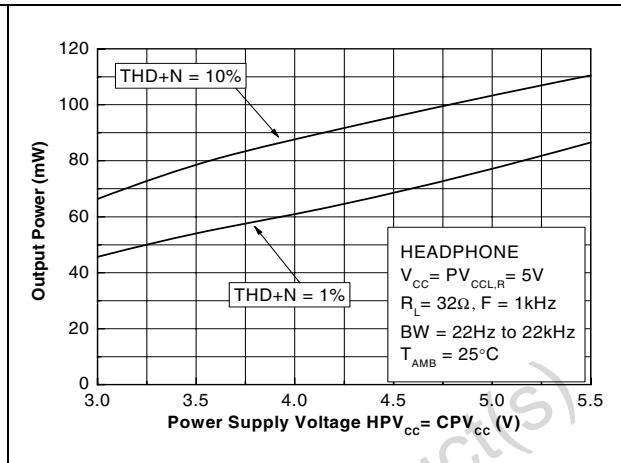

Figure 10. Output power vs. load resistance

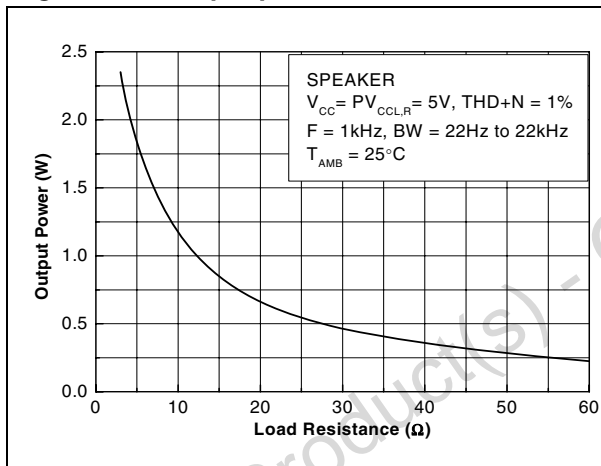

Figure 11. Output power vs. load resistance

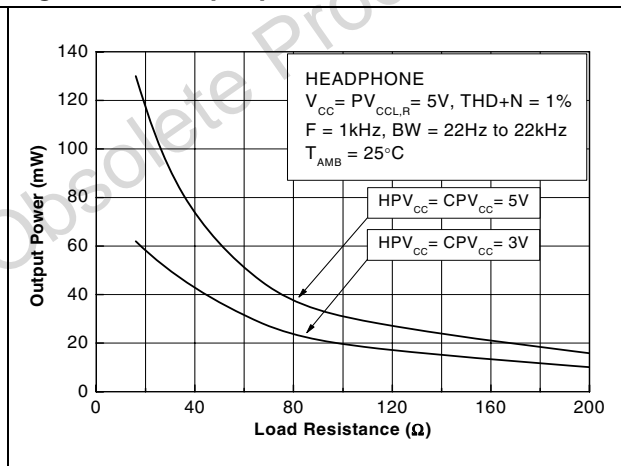

Figure 12. THD+N vs. output power

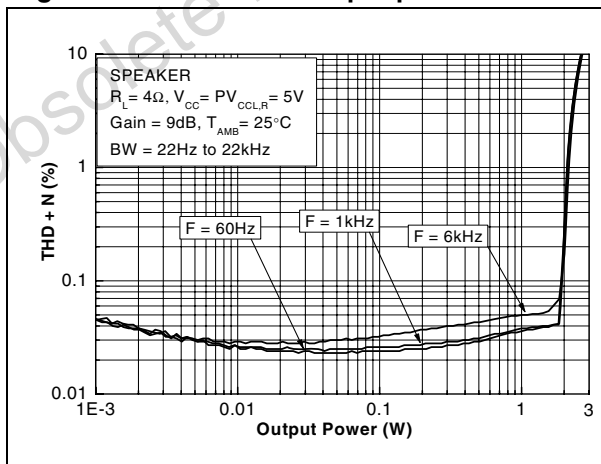

Figure 13. THD+N vs. output power

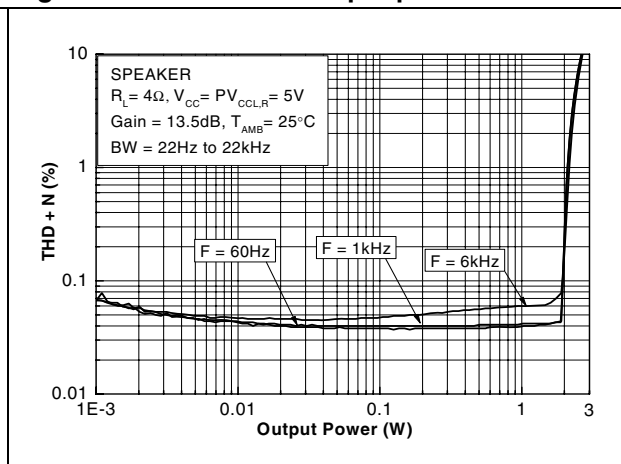

Figure 14. THD+N vs. output power

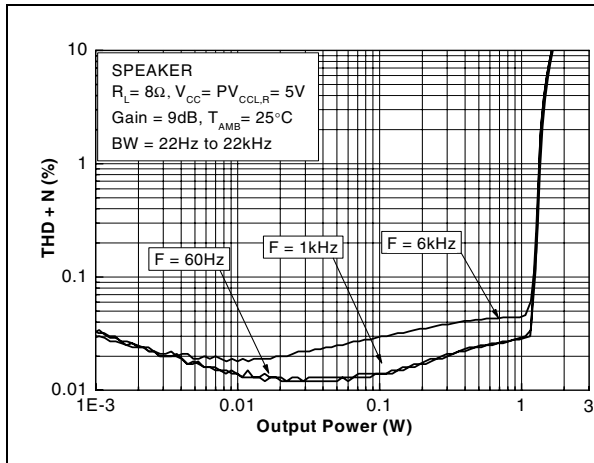

Figure 15. THD+N vs. output power

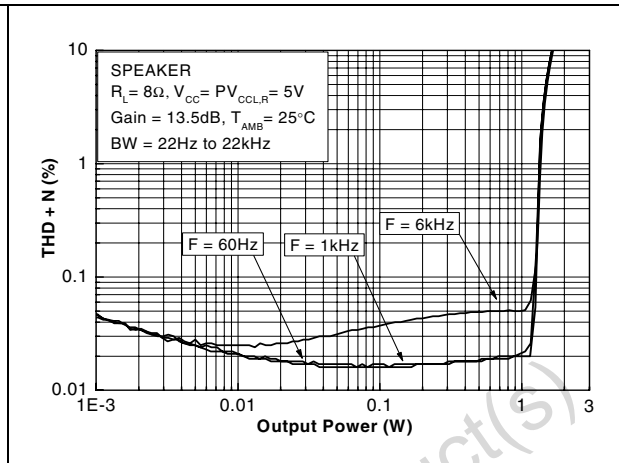

Figure 16. THD+N vs. output power

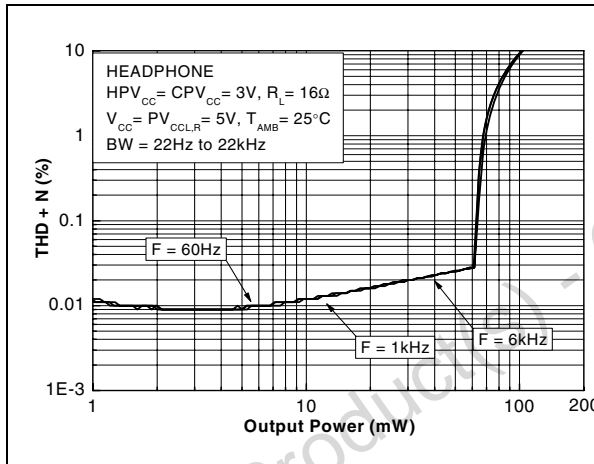

Figure 17. THD+N vs. output power

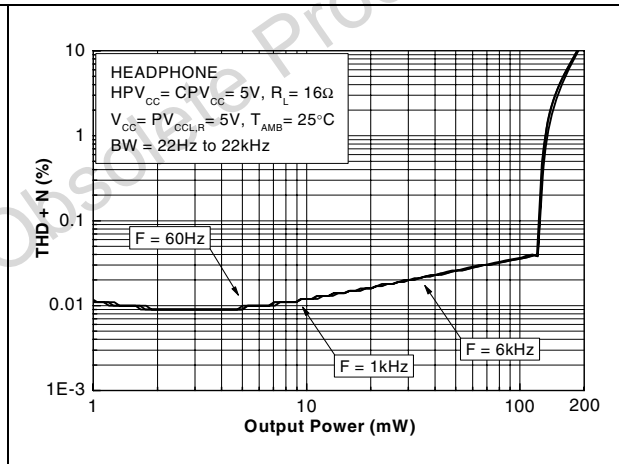

Figure 18. THD+N vs. output power

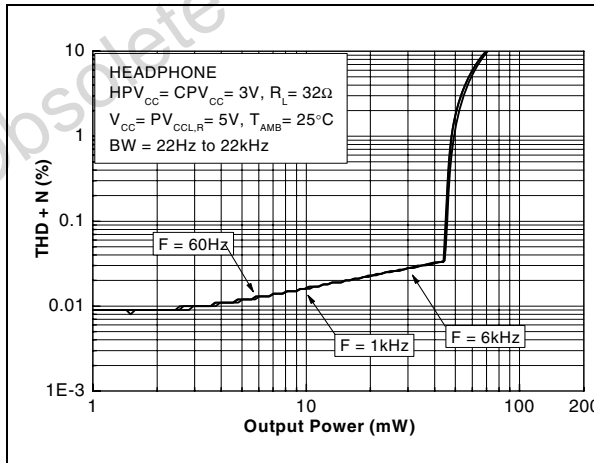

Figure 19. THD+N vs. output power

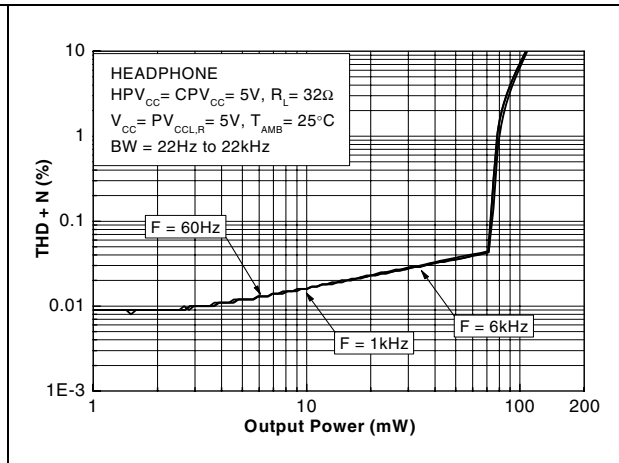

Figure 20. THD+N vs. frequency

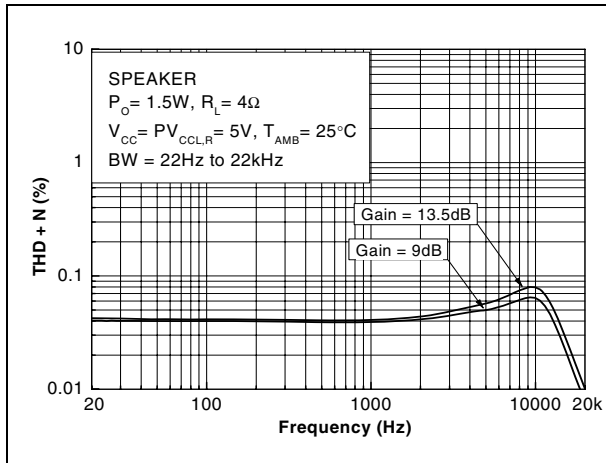

Figure 21. THD+N vs. frequency

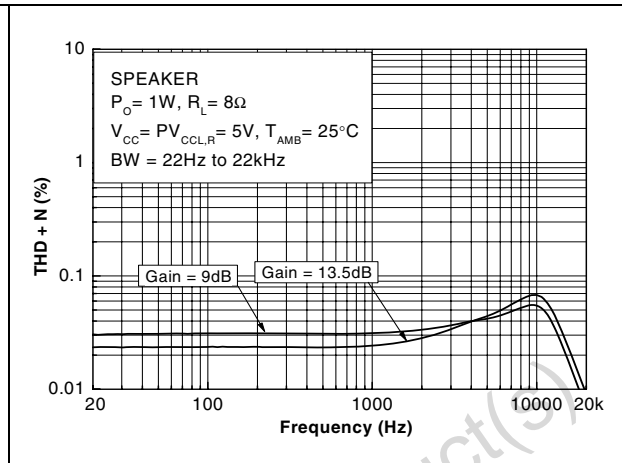

Figure 22. THD+N vs. frequency

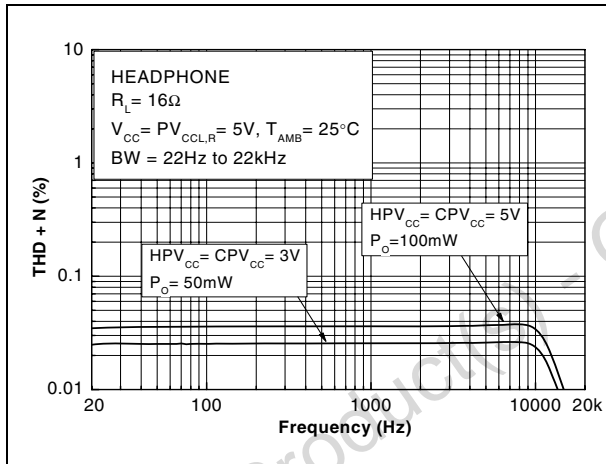

Figure 23. THD+N vs. frequency

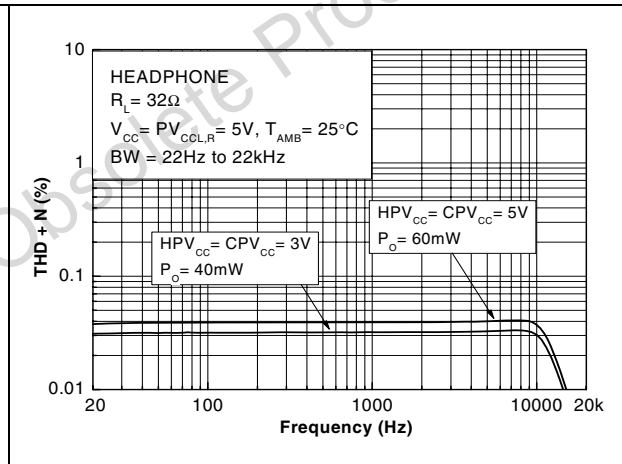

Figure 24. Power supply rejection ratio vs. frequency

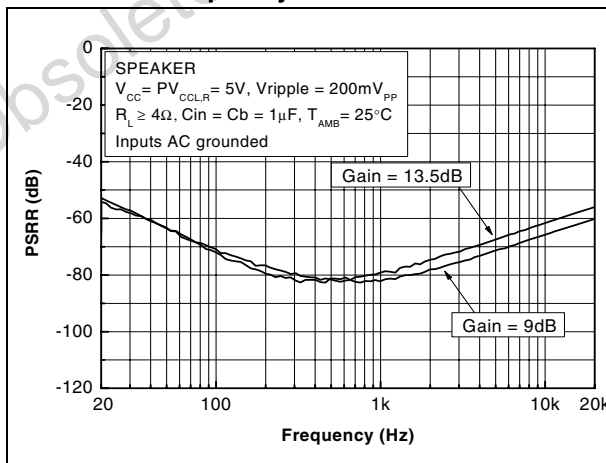

Figure 25. Power supply rejection ratio vs. frequency

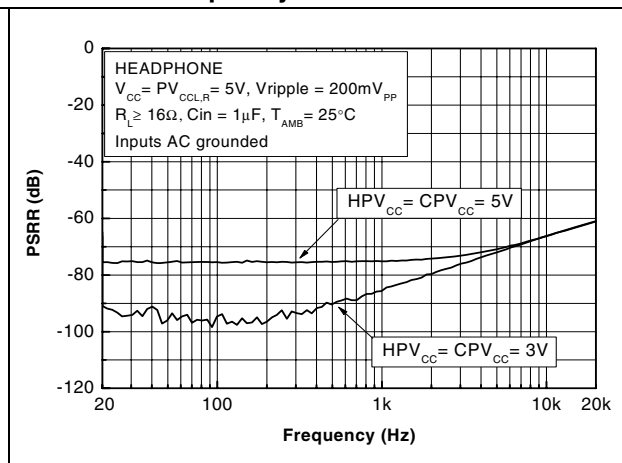

Figure 26. Wake-up time,
 $V_{CC}=PV_{CCL,R}=CPV_{CC}=HPV_{CC}=5V,$
 $V_{SPKREN}=V_{IH}$

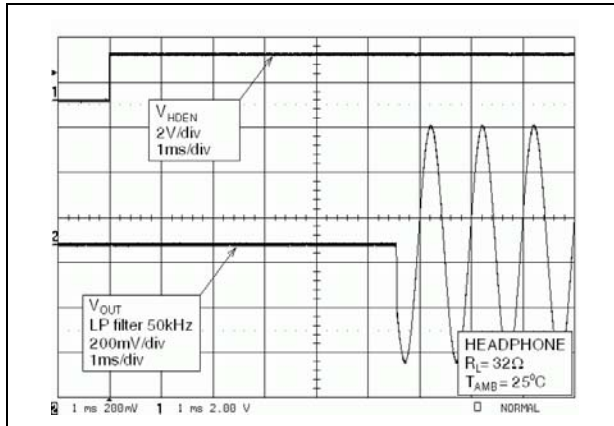

Figure 27. Standby time,
 $V_{CC}=PV_{CCL,R}=CPV_{CC}=HPV_{CC}=5V,$
 $V_{SPKREN}=V_{IH}$

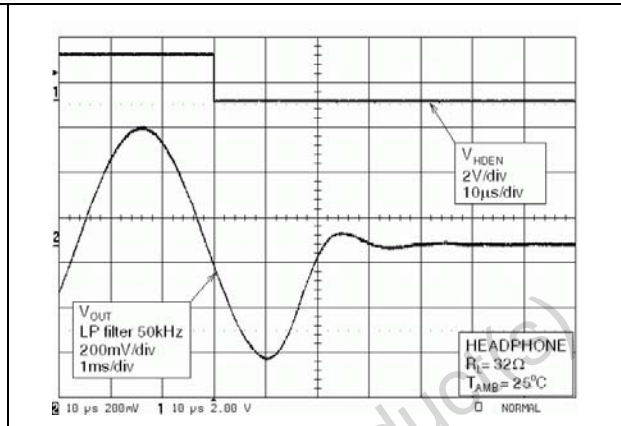

Figure 28. Wake-up time,
 $V_{CC}=PV_{CCL,R}=CPV_{CC}=HPV_{CC}=5V,$
 $V_{HDEN}=V_{IL}$

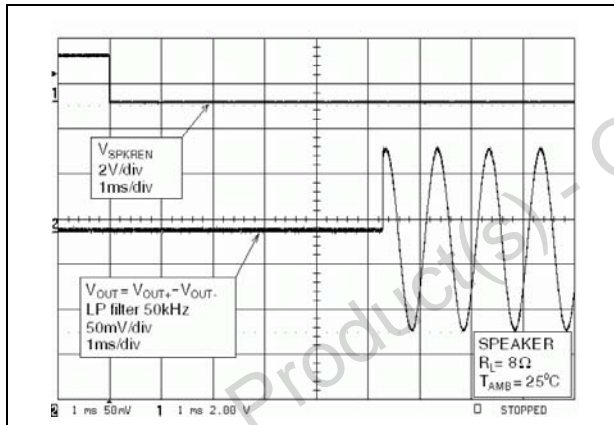

Figure 29. Standby time,
 $V_{CC}=PV_{CCL,R}=CPV_{CC}=HPV_{CC}=5V,$
 $V_{HDEN}=V_{IL}$

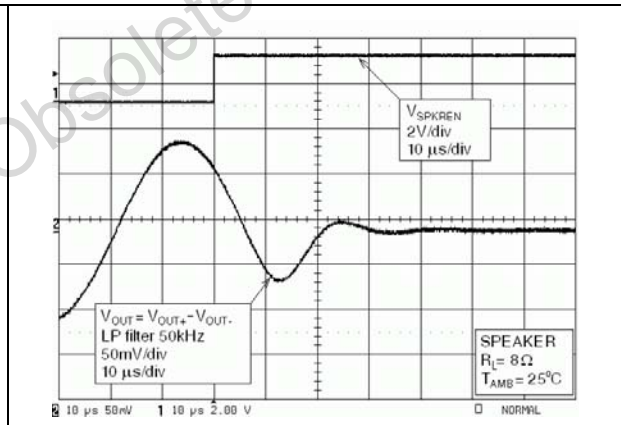

Figure 30. Crosstalk vs. frequency

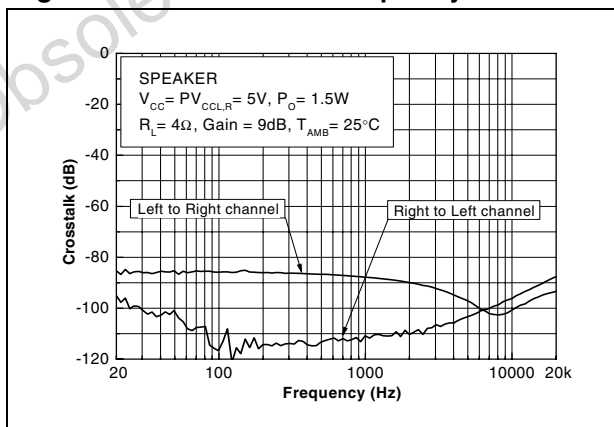

Figure 31. Crosstalk vs. frequency

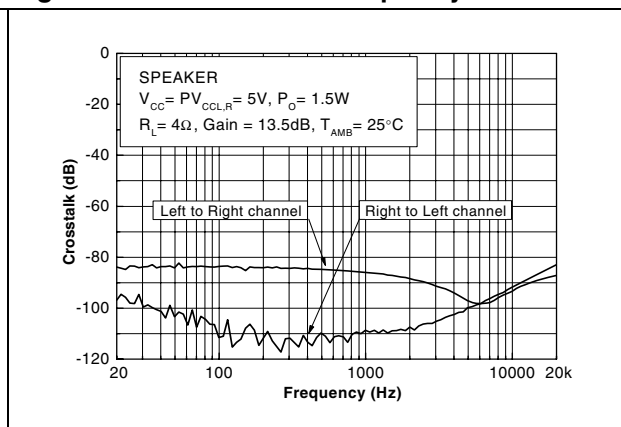

Figure 32. Crosstalk vs. frequency

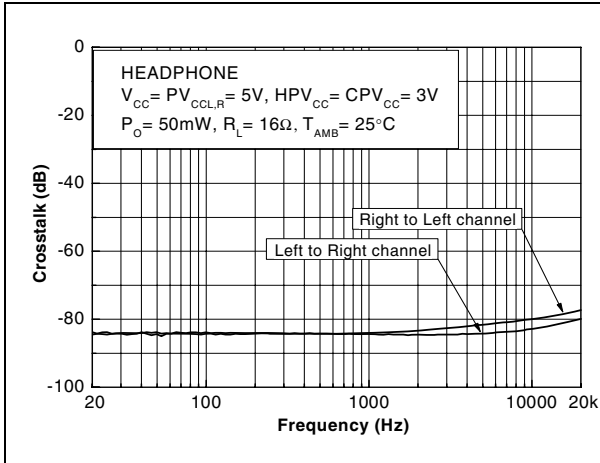

Figure 33. Crosstalk vs. frequency

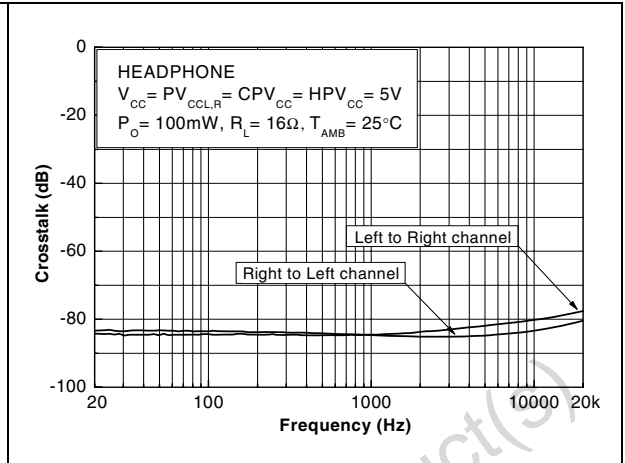

Figure 34. Inter-channel isolation vs. frequency

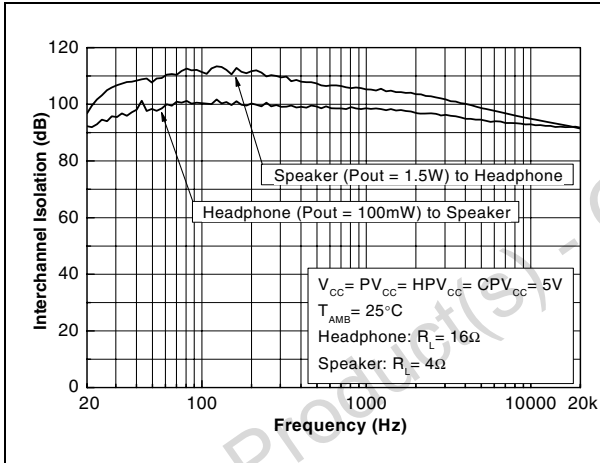

Figure 35. Power dissipation vs. output power per one channel

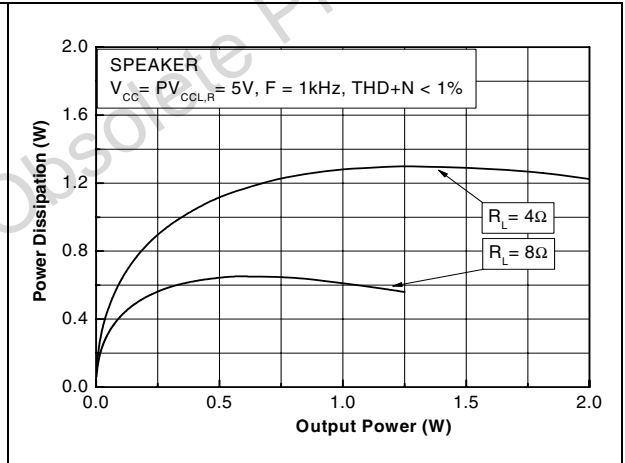

Figure 36. Power dissipation vs. output power per one channel

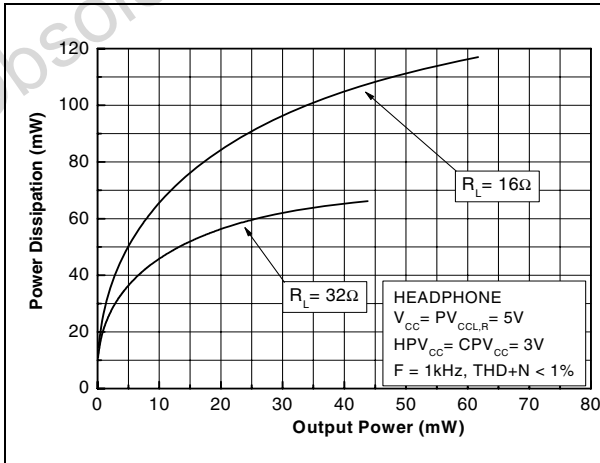
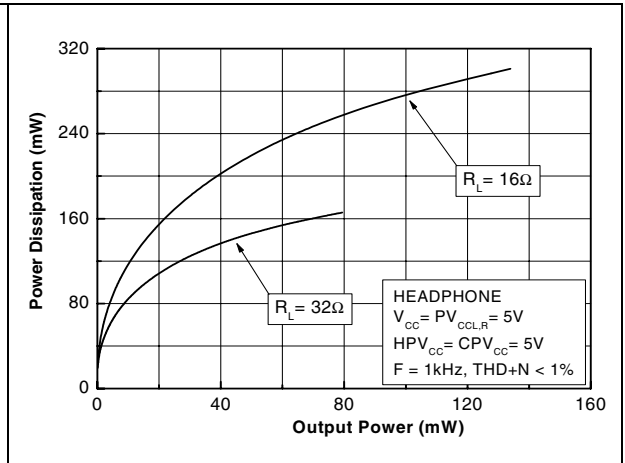

Figure 37. Power dissipation vs. output power per one channel



4 Application information

4.1 General description

The TS4982 is a stereo loudspeaker power amplifier and ground-referenced headphone driver with dedicated separated single-ended inputs in a QFN32 package, which is the best solution in space-saving applications. Each of the audio paths, loudspeaker or headphone, can be independently set to standby mode to save battery life.

The loudspeaker amplifier with BTL output configuration (see [Section 4.2: Loudspeaker BTL configuration principle on page 16](#)) can deliver 2 W output power into a 4 Ω load with both channels enabled at 1% THD+N with a nominal power supply of 5 V. The gain (see [Section 4.2](#)) of the loudspeaker amplifier can be set to four discrete levels thanks to two digital inputs. The stereo sound perception which could seem poor in an application (notebook) can be enhanced by a 3D effect internal block in three levels (see [Section 4.3: Power dissipation and efficiency on page 17](#)).

In the audio path which is not in standby mode, a PC beep signal is mixed if it is detected (see [Section 4.7: PC beep on page 21](#)) on the PC beep input.

The outputs are protected against over-current consumption which can appear when the outputs are short-circuited between them or to GND or Vcc. There is also an internal thermal shutdown activated at 150° C (typical) and deactivated at 120° C (typical).

4.2 Loudspeaker BTL configuration principle

Figure 38. Simplified schematic of the loudspeaker amplifier

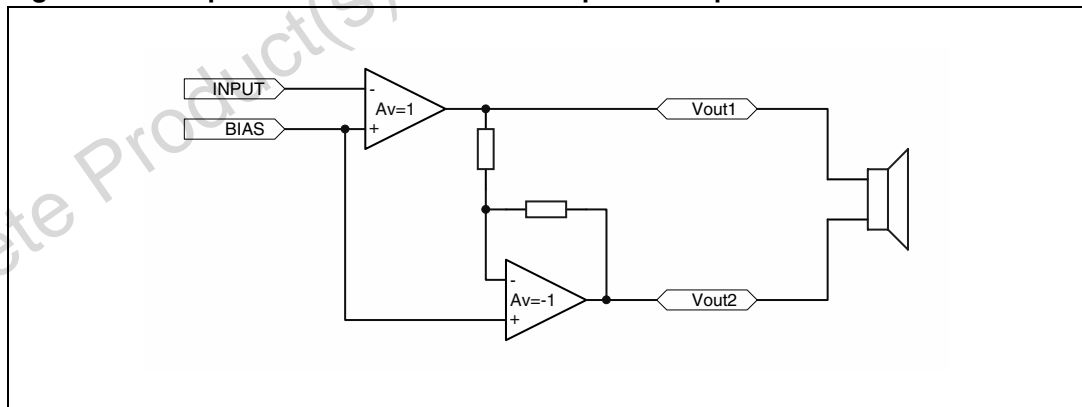

Bridge tied load (BTL) means that each end of the load is connected to two single-ended output amplifiers. Therefore, we have:

$$\text{Single-ended output 1} = V_{out1} = V_{out}$$

$$\text{Single-ended output 2} = V_{out2} = -V_{out}$$

$$\text{BTL output} = V_{out1} - V_{out2} = 2V_{out}$$

The output power is:

$$P_{out} = \frac{(2V_{outRMS})^2}{R_L}$$

For the same power supply voltage, the output power in a BTL configuration is four times higher than the output power in a single-ended configuration.

4.3 Power dissipation and efficiency

Hypotheses:

The voltage and current in the load are sinusoidal (V_{out} and I_{out}).

The supply voltage is a pure DC source (V_{CC}).

Regarding the load we have:

$$V_{out} = V_{PEAK} \sin \omega t \quad (V)$$

and

$$I_{out} = \frac{V_{out}}{R_L} \quad (A)$$

and

$$P_{out} = \frac{V_{PEAK}^2}{2R_L} \quad (W)$$

Therefore, the average current delivered by the supply voltage is:

$$I_{CC_{AVG}} = 2 \frac{V_{PEAK}}{\pi R_L} \quad (A)$$

Figure 39. Current delivered by power supply voltage

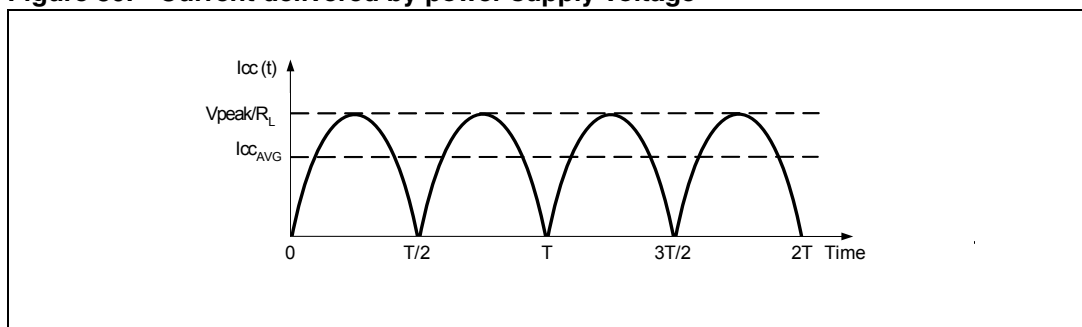

The power delivered by the supply voltage is:

$$P_{supply} = V_{CC} \cdot I_{CC_{AVG}} \quad (W)$$

Then, the **power dissipated by each amplifier** is:

$$P_{diss} = P_{supply} - P_{out} \quad (W)$$

$$P_{diss} = \frac{2\sqrt{2}V_{CC}}{\pi\sqrt{R_L}} \cdot \sqrt{P_{out}} - P_{out} \quad (W)$$

and the maximum value is obtained when:

$$\frac{\partial P_{diss}}{\partial P_{out}} = 0$$

and its value is:

$$P_{dissmax} = \frac{2V_{CC}^2}{\pi^2 R_L} \quad (W)$$

This maximum value only depends on the power supply voltage and load values.

The **efficiency**, η is the ratio between the output power and the power supply:

$$\eta = \frac{P_{out}}{P_{supply}} = \frac{\pi V_{PEAK}}{4V_{CC}}$$

The maximum theoretical value is reached when:

- $V_{PEAK} = V_{CC}$ for the loudspeaker part, so that:

$$\eta = \frac{\pi}{4} = 78.5\%$$

- $V_{PEAK} = V_{CC}/2$ for the headphone part, so that:

$$\eta = \frac{\pi}{8} = 39.3\%$$

4.4 Loudspeaker 3D effect enhancement

The TS4982 features a 3D audio effect which can be programmed at three discrete levels (LOW, MEDIUM, HIGH) through input pins 3D1 and 3D0 which provide a digital interface. The correspondence between the logic levels of this interface and 3D effect levels are shown in the [Table 12 on page 19](#).

The 3D audio effect applied to the stereo audio signals evokes perception of spatial hearing and improves this effect in cases where the stereo speakers are too close to each other, such as in small handheld devices or mobile equipment.

The perceived amount of 3D effect also depends on many factors such as speaker position, distance between speakers and listener, frequency spectrum of the audio signal, or the difference of signal between the left and right channels. In some cases, the volume can increase when the 3D effect is switched on. This factor depends on the composition of the stereo audio signal and its frequency spectrum.

Table 12. 3D effect settings

3D1	3D0	V _{3D1}	V _{3D0}	3D effect level
0	0	V _{IL}	V _{IL}	OFF
0	1	V _{IL}	V _{IH}	LOW
1	0	V _{IH}	V _{IL}	MEDIUM
1	1	V _{IH}	V _{IH}	HIGH

4.5 Low frequency response

Figure 40. Simplified schematic of input stage

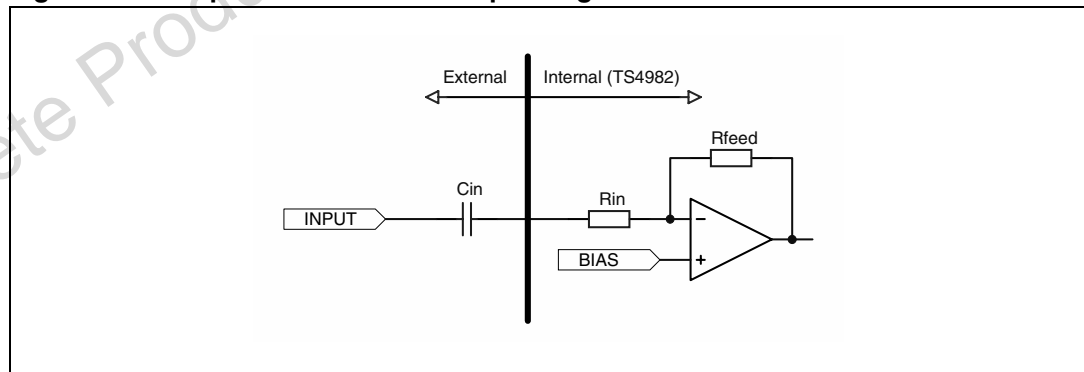

In the low-frequency region, the input coupling capacitor C_{in} starts to have an effect. C_{in} forms, with the R_{in} , a first order high-pass filter with a -3 dB cut-off frequency:

$$F_{CL} = \frac{1}{2\pi \cdot R_{in} \cdot C_{in}}$$

In this case we can consider that Rin equals Zin. So, for a desired cut-off frequency F_{CL}, C_{in} is calculated as follows:

$$C_{in} = \frac{1}{2\pi \cdot Z_{in} \cdot F_{CL}}$$

The input impedance Zin is for the whole power supply voltage range, typically 30 kΩ. There is also a tolerance around the typical value (see [Table 6 on page 7](#)) and it must be taken into account.

In the typical application, C_{in} = 1 μF, then F_{CL} = 5.3 Hz. If F_{CL} is required higher to limit low frequencies, it must be taken account that the speaker's PSRR performance for the low frequency region is decreased. The headphone PSRR remains the same.

Figure 41. PSRR vs. frequency

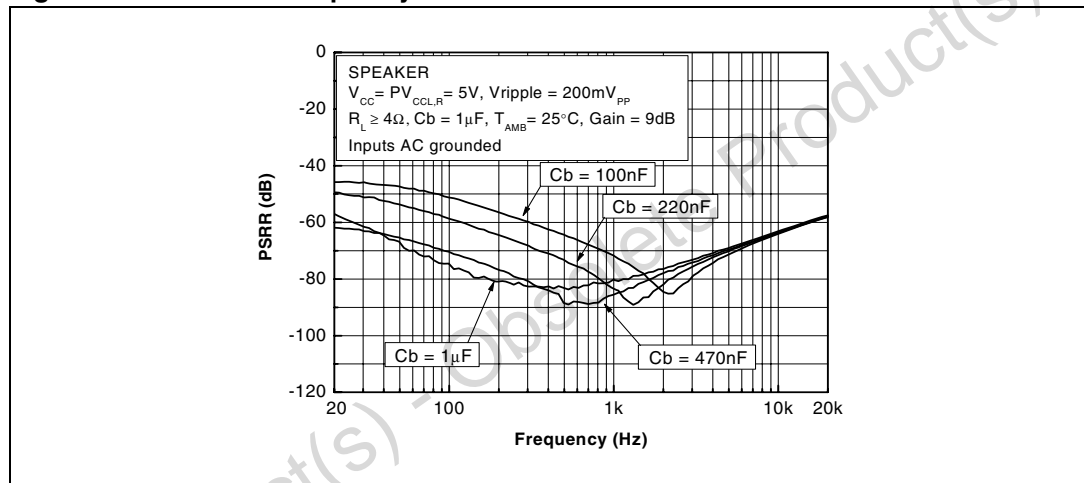

4.6 Gain settings

In the flat region of the frequency-response curve (no input coupling capacitor or internal feedback loop + load effect) the gain of the loudspeaker amplifier can be set in four discrete levels thanks to the two digital inputs G1 and G0.

The headphone amplifier gain does not depend on the loudspeaker gain setting and is kept equal to 3.5 dB.

Table 13. Gain settings

G1	G0	V _{G1}	V _{G0}	Loudspeaker amplifier gain (dB)	Headphone amplifier gain (dB)
0	0	V _{IL}	V _{IL}	9	3.5
0	1	V _{IL}	V _{IH}	10.5	3.5
1	0	V _{IH}	V _{IL}	12	3.5
1	1	V _{IH}	V _{IH}	13.5	3.5

4.7 PC beep

The PC beep input allows to send a system beep (for instance power-on self-test error code) through the amplifiers to the loudspeaker or (and) headphone output. In the typical application (see *Figure 1*) the input is passed through when eight sequential rising edges in the signal appear on the detector input with the minimum amplitude $V_{in_{MIN}} = 0.8 V_{P-P}$ and minimum frequency $F_{MIN} = 400$ Hz. The PC beep signal is mixed with gain = -1 V/V into a loudspeaker (SPKREN = 0) or headphone (HDEN = 1) path. The signal from the loudspeaker or headphone inputs are not muted. The beep signal pass-through is switched off when there is no signal with sufficient amplitude $V_{in_{MIN}}$ present during a $1/F_{MIN}$ (1/400 s) time period.

The overall gain in the typical application ($R_{in} = R_{feed} = 47\text{ k}\Omega$) is equal to the loudspeaker or headphone gain setting.

Figure 42. PC beep input stage

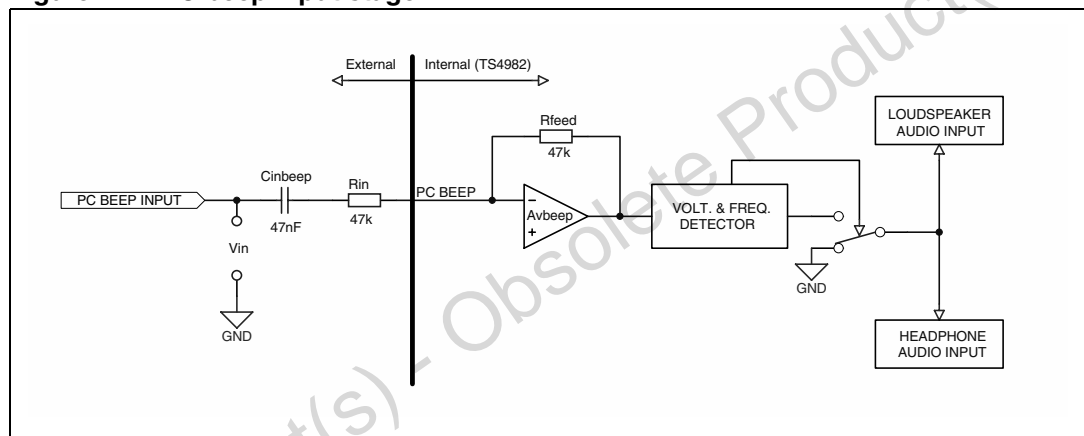

The input capacitor C_{inbeep} with input resistor R_{in} forms a high-pass filter with a -3 dB low frequency cut-off F_{CL} which must be lower than F_{MIN} .

$$C_{inbeep} \geq \frac{1}{2\pi \cdot R_{in} \cdot F_{MIN}}$$

For a typical application ($R_{in} = 47\text{ k}\Omega$, $F_{MIN} = 400$ Hz) a good choice is $C_{inbeep} = 47\text{ nF}$.

If it is necessary to change the minimum amplitude $V_{in_{MIN}} = 0.8 V_{P-P}$ the gain of the PC BEEP input amplifier has to be changed. For a typical application ($R_{in} = R_{feed} = 47\text{ k}\Omega$) the gain is -1 V/V.

$$A_v = -\frac{R_{feed}}{R_{in}} = -\frac{47000}{47000} = -1$$

If $V_{in_{MIN2}}$ is a new requested minimum amplitude then a new input resistor R_{in} is:

$$R_{in}[\Omega] = \frac{R_{feed} \cdot V_{in_{MIN2}}}{V_{in_{MIN}}} = 5875 \cdot V_{in_{MIN2}}[V_{PP}]$$

4.8 Decoupling and charge pump capacitors

Only a power supply decoupling capacitor C_s and a bias voltage decoupling capacitor C_b are needed to correctly decouple the TS4982.

4.8.1 Decoupling capacitors C_s and C_b

C_s has a particular influence on the THD+N in the high frequency region (above 7 kHz) and an indirect influence on the power supply disturbances. With a value for C_s of 1 μF , you can expect similar THD+N performances to those outlined in this document (see [Figure 12](#) to [Figure 23](#)). For example:

- In the high frequency region, if C_s is lower than 1 μF , it increases THD+N and disturbances on the power supply rail are less filtered.
- On the other hand, if C_s is higher than 1 μF , those disturbances on the power supply rail are more filtered.

C_b has a critical influence on the final result of the PSRR with input grounded and in the lower frequency region in the following manner:

- If C_b is lower than 1 μF the PSRR performance worsens at lower frequencies.
- If C_b is higher than 1 μF , the benefit to PSRR is decreased significantly.

Figure 43. PSRR vs. frequency

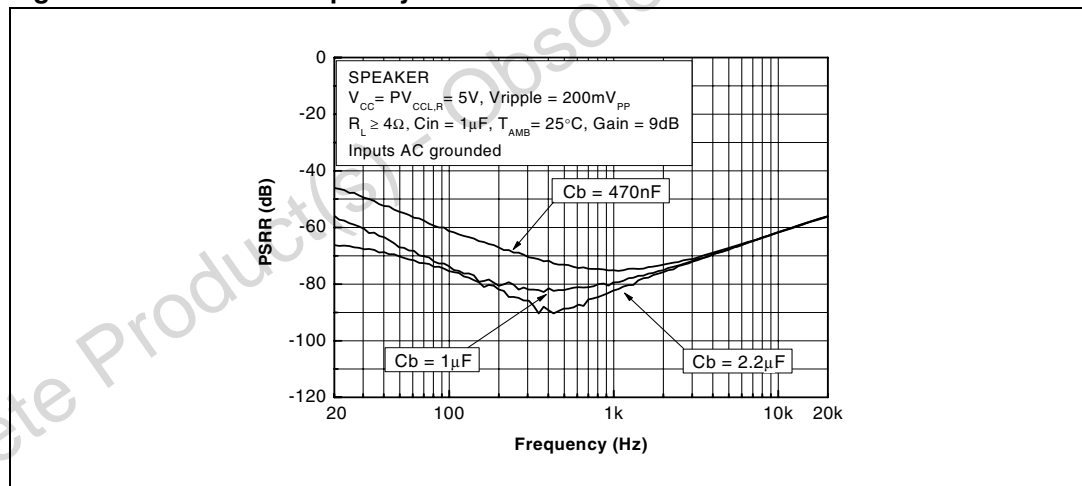

4.8.2 Charge pump capacitors Cp and Cps

A proper selection of the charge pump capacitors Cp and Cps is necessary to generate an efficient negative voltage by the internal charge pump without a negative impact on the audio performance.

The following are some recommendations for the decoupling and charge pump capacitors.

- Low ESR capacitors are needed to minimize the output resistance of the charge pump.
- An X7R dielectric type for large temperature ranges should be used.
- Placement of the component as close to the package pins as possible. Small packages (for instance SMD 0603, 0402) make it easier.
- Use of a 10 V DC rating voltage for 5 V operation or 6.3 V DC rating operation for 3 V operation with regard to the $\Delta C/\Delta V$ variation of this type of dielectric.
- For a typical application a 1 μF ceramic capacitor is recommended (see [Figure 1 on page 5](#)).

4.9 Wake-up time

When the standby is released to turn the device ON, the bypass capacitor Cb is charged immediately. As Cb is directly linked to the bias of the loudspeaker amplifier, the bias will not work properly until the Cb voltage is correct. The time to reach this voltage plus a time delay of 1 ms (pop precaution) is called **the wake-up time** or t_{WU} . It is specified in the electrical characteristics with Cb = 1 μF in [Table 7 on page 7](#).

If Cb has a value other than 1 μF , you can calculate the typical t_{WU} by using the following formula, or read it directly from the graph ([Figure 44](#)).

$$t_{\text{WU}}[\text{s}] = 5199 \cdot C_b + 0.001[\text{F}]$$

Figure 44. Typical wake-up time vs. bypass capacitor

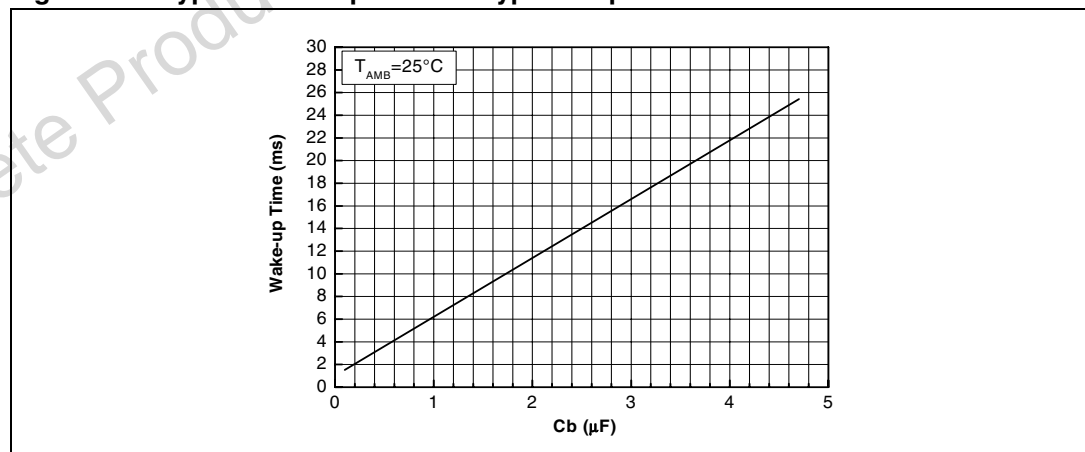

If the headphone (speaker) is already out of the standby mode and the speaker (headphone) is enabled there is no need to charge Cb. Therefore, the wake-up time is only the pop precaution delay of 1 ms (typical).

4.10 Standby time

The time to disable the dedicated part into the standby mode since the level of the dedicated standby pins are changed (HDEN from "1" to "0", SPKREN from "0" to "1") is called the **standby time**. It is specified in the electrical characteristics in [Table 7 on page 7](#).

4.11 Pop & click

Older generations of headphone drivers with single-ended outputs have a load connected in series with a bulky capacitor (for instance 220 μF) to ground. With this type of configuration, when the amplifier is turned on by a standby control pin, a time transient phenomena on the load is present. This has been the main contribution to the unpleasant audible sound currently called "pop effect".

Thanks to the negative charge pump the headphone outputs are referred to ground without the need for bulky in-series capacitors. Therefore, the pop created by these bulky capacitors is internally eliminated. In addition, the TS4982 include a pop & click circuitry which suppresses any residual pop on the headphone and speaker outputs, thus enabling the outputs to be virtually pop & click-free.

4.12 Headphone jack detection

The device incorporates a simple circuitry that can be used to enable the headphone amplifier and disable the speaker amplifier by a headphone jack insertion.

Figure 45. Headphone jack detection schematics

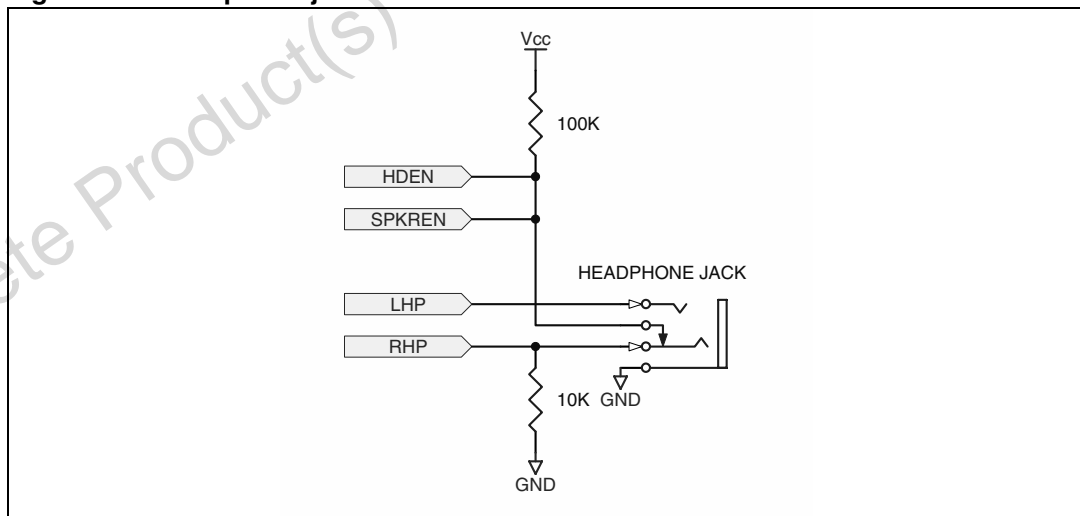

4.13 PCB layout recommendations

The TS4982 can delivery 2 W into a 4 Ω load at 1% THD+N. To reach this output power value, you should follow these few recommendations during the design phase of the PCB.

- Use large and short traces for power supply ($PV_{CCL,R}$) and outputs - load tracks to minimize losses due to track parasitic resistance.
- Connect all V_{CC} tracks ($PV_{CCL,R}$, HPV_{CC} , CPV_{CC} , V_{CC}) to one point on the board.
- Connect all grounding planes or tracks (GND, PGNDL, PGNDR, CPGND) to one point on the board.
- Keep the grounding of the charge pump CPGND away from other GNDs.
- Connect the exposed pad to the grounding plane or a large bottom copper area using vias for good heatsink.

Obsolete Product(s) - Obsolete Product(s)

5 Package information

In order to meet environmental requirements, ST offers these devices in different grades of ECOPACK[®] packages, depending on their level of environmental compliance. ECOPACK[®] specifications, grade definitions and product status are available at: www.st.com. ECOPACK[®] is an ST trademark.

Obsolete Product(s) - Obsolete Product(s)

5.1 QFN32 package information

Figure 46. QFN32 package mechanical drawing

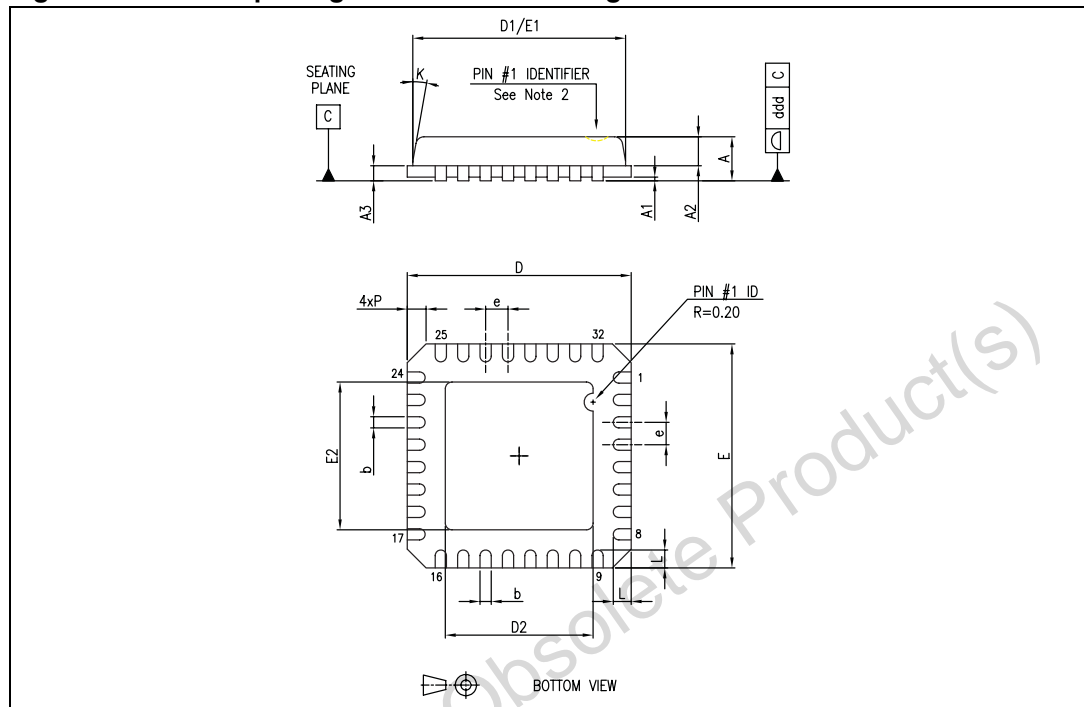
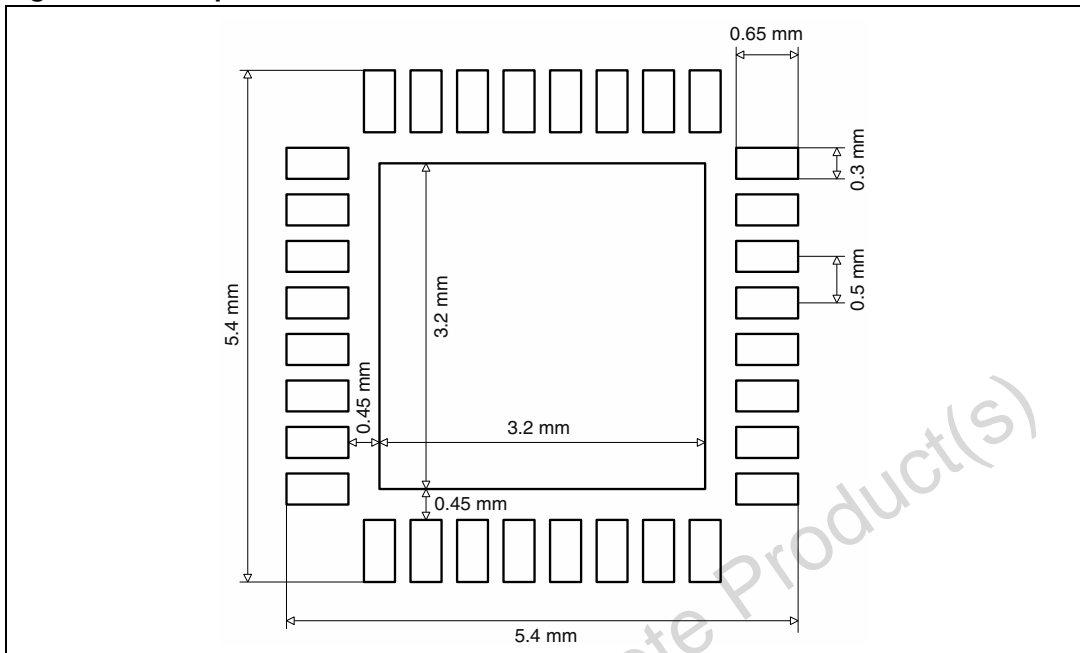

Table 14. QFN32 package mechanical data

Ref.	Dimensions					
	Millimeters			Inches		
	Min.	Typ.	Max.	Min.	Typ.	Max.
A	0.80	0.90	1.00	0.031	0.035	0.039
A1		0.02	0.05		0.0008	0.002
A2		0.65	1.00		0.026	0.039
A3		0.20			0.008	
b	0.18	0.25	0.30	0.007	0.010	0.012
D	4.85	5.00	5.15	0.191	0.20	0.203
D1		4.75			0.19	
D2	3.15	3.30	3.45	0.124	0.130	0.136
E	4.85	5.00	5.15	0.191	0.20	0.203
E1		4.75			0.19	
E2	3.15	3.30	3.45	0.124	0.130	0.136
e		0.50			0.020	
L	0.30	0.40	0.50	0.012	0.016	0.020
P			0.60			0.024
K			14			0.55
ddd			0.08			0.003

Figure 47. Footprint recommendation



Obsolete Product(s) - Obsolete Product(s)

6 Ordering information

Table 15. Order code

Order code	Temperature range	Package	Packaging	Marking
TS4982IQT	-40°C to +85°C	QFN32	Tape & reel	K982

Obsolete Product(s) - Obsolete Product(s)

7 Revision history

Table 16. Document revision history

Date	Revision	Changes
18-Mar-2008	1	Initial release.
16-Jun-2009	2	Document status promoted from target specification to full datasheet.

Obsolete Product(s) - Obsolete Product(s)

Please Read Carefully:

Information in this document is provided solely in connection with ST products. STMicroelectronics NV and its subsidiaries ("ST") reserve the right to make changes, corrections, modifications or improvements, to this document, and the products and services described herein at any time, without notice.

All ST products are sold pursuant to ST's terms and conditions of sale.

Purchasers are solely responsible for the choice, selection and use of the ST products and services described herein, and ST assumes no liability whatsoever relating to the choice, selection or use of the ST products and services described herein.

No license, express or implied, by estoppel or otherwise, to any intellectual property rights is granted under this document. If any part of this document refers to any third party products or services it shall not be deemed a license grant by ST for the use of such third party products or services, or any intellectual property contained therein or considered as a warranty covering the use in any manner whatsoever of such third party products or services or any intellectual property contained therein.

UNLESS OTHERWISE SET FORTH IN ST'S TERMS AND CONDITIONS OF SALE ST DISCLAIMS ANY EXPRESS OR IMPLIED WARRANTY WITH RESPECT TO THE USE AND/OR SALE OF ST PRODUCTS INCLUDING WITHOUT LIMITATION IMPLIED WARRANTIES OF MERCHANTABILITY, FITNESS FOR A PARTICULAR PURPOSE (AND THEIR EQUIVALENTS UNDER THE LAWS OF ANY JURISDICTION), OR INFRINGEMENT OF ANY PATENT, COPYRIGHT OR OTHER INTELLECTUAL PROPERTY RIGHT.

UNLESS EXPRESSLY APPROVED IN WRITING BY AN AUTHORIZED ST REPRESENTATIVE, ST PRODUCTS ARE NOT RECOMMENDED, AUTHORIZED OR WARRANTED FOR USE IN MILITARY, AIR CRAFT, SPACE, LIFE SAVING, OR LIFE SUSTAINING APPLICATIONS, NOR IN PRODUCTS OR SYSTEMS WHERE FAILURE OR MALFUNCTION MAY RESULT IN PERSONAL INJURY, DEATH, OR SEVERE PROPERTY OR ENVIRONMENTAL DAMAGE. ST PRODUCTS WHICH ARE NOT SPECIFIED AS "AUTOMOTIVE GRADE" MAY ONLY BE USED IN AUTOMOTIVE APPLICATIONS AT USER'S OWN RISK.

Resale of ST products with provisions different from the statements and/or technical features set forth in this document shall immediately void any warranty granted by ST for the ST product or service described herein and shall not create or extend in any manner whatsoever, any liability of ST.

ST and the ST logo are trademarks or registered trademarks of ST in various countries.

Information in this document supersedes and replaces all information previously supplied.

The ST logo is a registered trademark of STMicroelectronics. All other names are the property of their respective owners.

© 2009 STMicroelectronics - All rights reserved

STMicroelectronics group of companies

Australia - Belgium - Brazil - Canada - China - Czech Republic - Finland - France - Germany - Hong Kong - India - Israel - Italy - Japan - Malaysia - Malta - Morocco - Philippines - Singapore - Spain - Sweden - Switzerland - United Kingdom - United States of America

www.st.com

