

**■ Features**

- High Luminous LEDs
- 8mm Round Standard Directivity
- Long Lifetime Operation
- UV Resistant Epoxy
- Water Clear Type
- Bi-polar Type

**■ Applications**

- Electronic Signs and Signals
- Small Area Illuminations
- Back Lighting
- Other Lighting

**■ Outline Dimension**

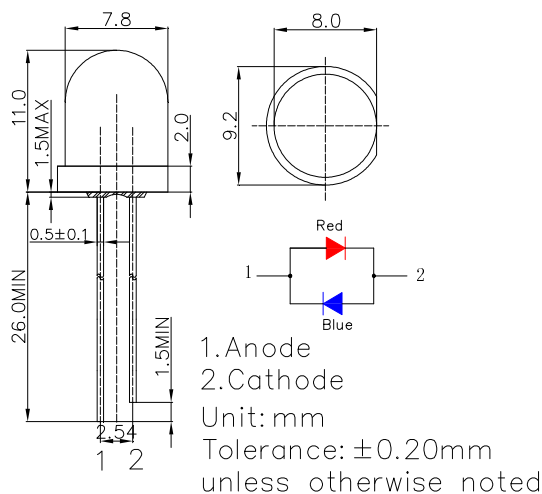

**■ Absolute Maximum Rating**

(Ta=25°C)

Item	Symbol	Value		Unit
		Red	Blue	
DC Forward Current	I <sub>F</sub>	50	30	mA
Pulse Forward Current#	I <sub>FP</sub>	100	100	mA
Reverse Voltage	V <sub>R</sub>	5	5	V
Power Dissipation	P <sub>D</sub>	130	102	mW
Operating Temperature	T <sub>opr</sub>	-30~ +85		°C
Storage Temperature	T <sub>stg</sub>	-40 ~ +100		°C
Lead Soldering Temperature	T <sub>sol</sub>	260°C/5sec		-

#Pulse width Max.10ms Duty ratio max 1/10

**■ Directivity**

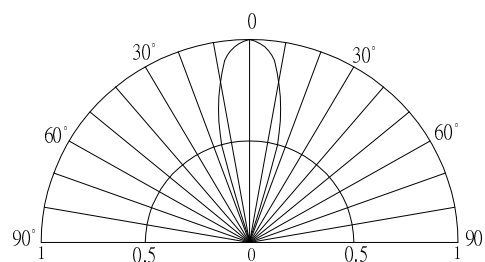

**■ Electrical -Optical Characteristics**

(Ta=25°C)

Item	Symbol	Condition	Min.	Typ.	Max.	Unit
DC Forward Voltage*1	V <sub>F</sub> (Red)	I <sub>F</sub> =20mA	-	2.1	2.6	V
	V <sub>F</sub> (Blue)	I <sub>F</sub> =20mA	-	2.9	3.4	V
DC Reverse Current	I <sub>R</sub>	V <sub>R</sub> =5V	-	-	10	μA
Domi. Wavelength*2	λ <sub>D</sub> (Red)	I <sub>F</sub> =20mA	620	625	630	nm
	λ <sub>D</sub> (Blue)	I <sub>F</sub> =20mA	465	470	475	nm
Luminous Intensity*3	I <sub>v</sub> (Red)	I <sub>F</sub> =20mA	4200	5800	-	mcd
	I <sub>v</sub> (Blue)	I <sub>F</sub> =20mA	3000	4200	-	mcd
50% Power Angle	2θ <sub>1/2</sub>	I <sub>F</sub> =20mA	-	30	-	deg

\*1 Tolerance of measurements of forward voltage is ±0.1V

\*2 Tolerance of measurements of dominant wavelength is ±1nm

\*3 Tolerance of measurements of luminous intensity is ±15%