

REVISIONS					
P	LTR	DESCRIPTION	DATE	DWN	APVD
	BA2	ECR-17-013465	13SEP2017	RK	TN

NOTES:

1. FOR FURTHER INFORMATION SEE DATA SHEET FOR C SERIES-HIGH POWER RESISTORS
2. WEIGHT 0.400 Kg PER 100 PIECES

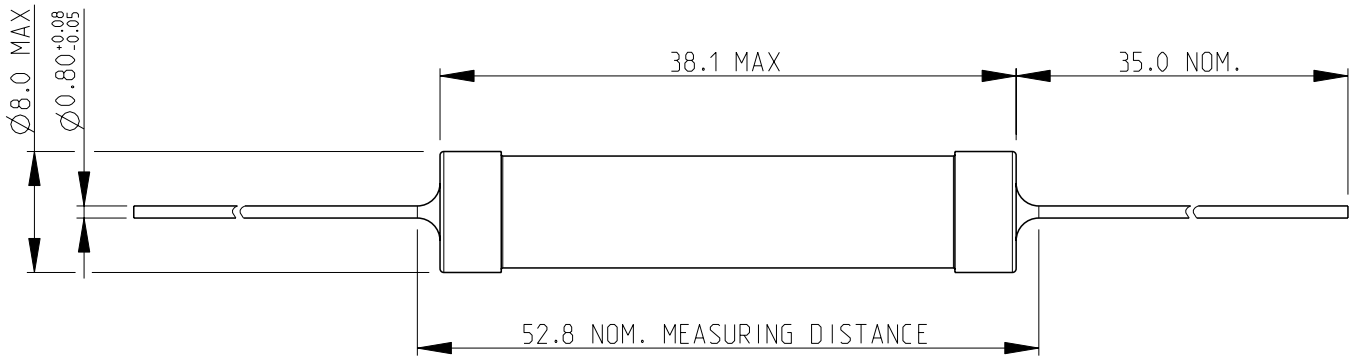

RoHS Compliant

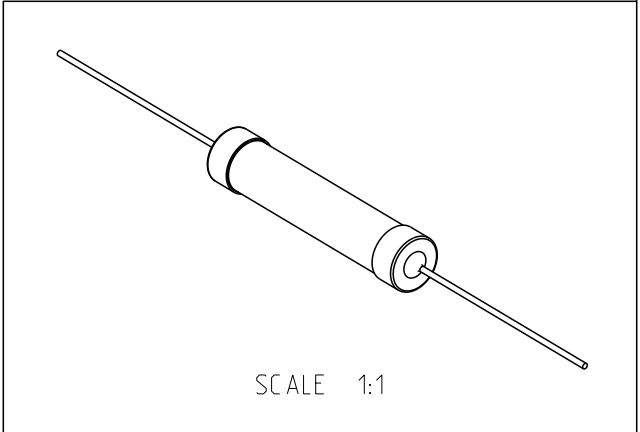

2008

RELEASED FOR PUBLICATION

ALL RIGHTS RESERVED.

THIS DRAWING IS UNPUBLISHED.

BY -

© COPYRIGHT 2008

DIMENSIONS: mm	DWN	16-Sep-08	MATERIAL	-	FINISH	-
	CHK	16-Sep-08				
TOLERANCES UNLESS OTHERWISE SPECIFIED:	APVD	16-Sep-08				
0 PLC ± 0.2	PRODUCT SPEC	-	NAME HIGH POWER RESISTORS			
1 PLC ± 0.1	APPLICATION SPEC	-	SERIES C10			
2 PLC \pm	WEIGHT	-	SIZE	CAGE CODE	DRAWING NO	RESTRICTED TO
3 PLC \pm		-	A 4	00779	C=1623773	-
4 PLC \pm			CUSTOMER DRAWING	SCALE	SHEET	REV
ANGLES $\pm 5^\circ$			2:1	1 OF 1	BA2	

Mouser Electronics

Authorized Distributor

Click to View Pricing, Inventory, Delivery & Lifecycle Information:

[TE Connectivity:](#)

[C1047KJL](#)