

**WAGO → I/O → SYSTEM 750**

**Fieldbus Independent  
I/O Modules**

**Pulse Width Output Module  
750-511, (/xxx-xxx)**



**Manual**

Version 1.0.2

Copyright © 2006 by WAGO Kontakttechnik GmbH & Co. KG  
All rights reserved.

**WAGO Kontakttechnik GmbH & Co. KG**

Hansastraße 27  
D-32423 Minden

Phone: +49 (0) 571/8 87 – 0  
Fax: +49 (0) 571/8 87 – 1 69  
E-Mail: [info@wago.com](mailto:info@wago.com)  
Web: <http://www.wago.com>

**Technical Support**

Phone: +49 (0) 571/8 87 – 5 55  
Fax: +49 (0) 571/8 87 – 85 55  
E-Mail: [support@wago.com](mailto:support@wago.com)

Every conceivable measure has been taken to ensure the correctness and completeness of this documentation. However, as errors can never be fully excluded, we would appreciate any information or ideas at any time.

E-Mail: [documentation@wago.com](mailto:documentation@wago.com)

We wish to point out that the software and hardware terms as well as the trademarks of companies used and/or mentioned in the present manual are generally trademark or patent protected.

# Content

<b>1 Important Comments .....</b>	<b>4</b>
1.1 Legal Principles .....	4
1.1.1 Copyright .....	4
1.1.2 Personnel Qualification .....	4
1.1.3 Intended Use .....	4
1.2 Symbols .....	5
1.3 Number Notation .....	5
1.4 Safety Notes .....	6
1.5 Scope .....	6
<b>2 I/O Modules .....</b>	<b>7</b>
2.1 Special Module .....	7
2.1.1 Overview 750-511, (/xxx-xxx) [Pulse Width Output Module] .....	7
2.1.2 750-511, /000-002 [2DO 24V DC 0.1A / Pulse Width] .....	8
2.1.2.1 View .....	8
2.1.2.2 Variations .....	8
2.1.2.3 Description .....	8
2.1.2.4 Display Elements .....	9
2.1.2.5 Schematic Diagram .....	10
2.1.2.6 Technical Data .....	11
2.1.2.7 Process Image .....	12
2.1.2.8 Example .....	13
2.1.2.9 Parameterizing the Period / Pulse frequency .....	14
2.1.2.9.1 Register .....	14
2.1.2.9.2 Control- / Status byte .....	14
2.1.2.9.3 Example 750-511 .....	15
2.1.2.9.4 Example 750-511/000-002 .....	17
2.1.3 750-511/000-001 [2DO 24V DC 0,1A/Frequency/2kHz] .....	19
2.1.3.1 View .....	19
2.1.3.2 Description .....	19
2.1.3.3 Display Elements .....	20
2.1.3.4 Schematic Diagram .....	21
2.1.3.5 Technical Data .....	22
2.1.3.6 Process Image .....	23

# 1 Important Comments

To ensure fast installation and start-up of the units described in this manual, we strongly recommend that the following information and explanations are carefully read and abided by.

## 1.1 Legal Principles

### 1.1.1 Copyright

This manual is copyrighted, together with all figures and illustrations contained therein. Any use of this manual which infringes the copyright provisions stipulated herein, is not permitted. Reproduction, translation and electronic and photo-technical archiving and amendments require the written consent of WAGO Kontakttechnik GmbH & Co. KG. Non-observance will entail the right of claims for damages.

WAGO Kontakttechnik GmbH & Co. KG reserves the right to perform modifications allowed by technical progress. In case of grant of a patent or legal protection of utility patents all rights are reserved by WAGO Kontakttechnik GmbH & Co. KG. Products of other manufacturers are always named without referring to patent rights. The existence of such rights can therefore not be ruled out.

### 1.1.2 Personnel Qualification

The use of the product detailed in this manual is exclusively geared to specialists having qualifications in PLC programming, electrical specialists or persons instructed by electrical specialists who are also familiar with the valid standards. WAGO Kontakttechnik GmbH & Co. KG declines all liability resulting from improper action and damage to WAGO products and third party products due to non-observance of the information contained in this manual.

### 1.1.3 Intended Use

For each individual application, the components supplied are to work with a dedicated hardware and software configuration. Modifications are only permitted within the framework of the possibilities documented in the manuals. All other changes to the hardware and/or software and the non-conforming use of the components entail the exclusion of liability on part of WAGO Kontakttechnik GmbH & Co. KG.

Please direct any requirements pertaining to a modified and/or new hardware or software configuration directly to WAGO Kontakttechnik GmbH & Co. KG.

## 1.2 Symbols



### **Danger**

Always abide by this information to protect persons from injury.



### **Warning**

Always abide by this information to prevent damage to the device.



### **Attention**

Marginal conditions must always be observed to ensure smooth operation.



### **ESD (Electrostatic Discharge)**

Warning of damage to the components by electrostatic discharge. Observe the precautionary measure for handling components at risk.



### **Note**

Routines or advice for efficient use of the device and software optimization.



### **More information**

References on additional literature, manuals, data sheets and INTERNET pages

## 1.3 Number Notation

Number Code	Example	Note
Decimal	100	normal notation
Hexadecimal	0x64	C notation
Binary	'100' '0110.0100'	Within ', Nibble separated with dots

## 1.4 Safety Notes



---

### Warning

Switch off the system prior to working on bus modules!

In the event of deformed contacts, the module in question is to be replaced, as its functionality can no longer be ensured on a long-term basis.

The components are not resistant against materials having seeping and insulating properties. Belonging to this group of materials is: e.g. aerosols, silicones, triglycerides (found in some hand creams).

If it cannot be ruled out that these materials appear in the component environment, then additional measures are to be taken:

- installation of the components into an appropriate enclosure
  - handling of the components only with clean tools and materials.
- 



---

### Attention

Cleaning of soiled contacts may only be done with ethyl alcohol and leather cloths. Thereby, the ESD information is to be regarded.

Do not use any contact spray. The spray may impair the functioning of the contact area.

The WAGO-I/O-SYSTEM 750 and its components are an open system. It must only be assembled in housings, cabinets or in electrical operation rooms. Access must only be given via a key or tool to authorized qualified personnel.

The relevant valid and applicable standards and guidelines concerning the installation of switch boxes are to be observed.

---



---

### ESD (Electrostatic Discharge)

The modules are equipped with electronic components that may be destroyed by electrostatic discharge. When handling the modules, ensure that the environment (persons, workplace and packing) is well grounded. Avoid touching conductive components, e.g. gold contacts.

---

## 1.5 Scope

This manual describes the Special Module 750-511, (/xxx-xxx) Pulse Width Output Module of the modular WAGO-I/O-SYSTEM 750.

Handling, assembly and start-up are described in the manual of the Fieldbus Coupler. Therefore this documentation is valid only in the connection with the appropriate manual.

## 2 I/O Modules

### 2.1 Special Module

#### 2.1.1 Overview 750-511, (/xxx-xxx) [Pulse Width Output Module]

I/O Module	<a href="#">750-511</a>	<a href="#">750-511/ 000-001</a>	<a href="#">750-511/ 000-002</a>
Pulse frequency	250 Hz, configurable	adjustable, 2 Hz ... 2 kHz	100 Hz, configurable
On/Off ratio	adjustable, 0 ... 100 %	50 %, fix preset	adjustable, 0 ... 100 %
Channels	2 pulse width outputs with same pulse frequency	1 frequency output 1 directional output	2 pulse width outputs with same pulse frequency

## 2.1.2 750-511, /000-002 [2DO 24V DC 0.1A / Pulse Width]

2-Channel Pulse Width Output Module DC 24 V

### 2.1.2.1 View

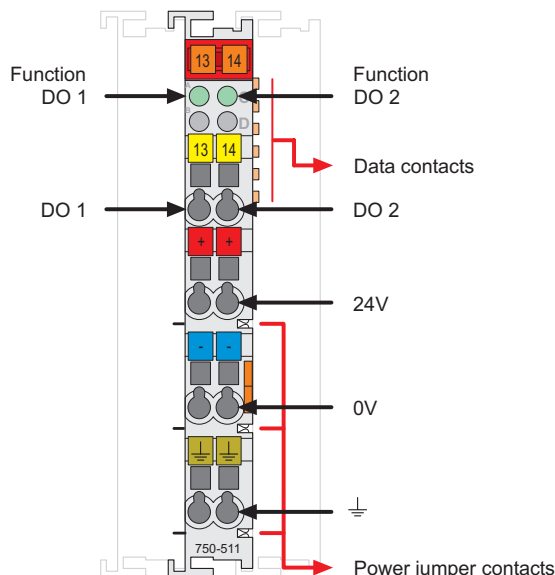

Fig. 2.1.2-1: 2-Channel Pulse Width Output Module 750-511

g051100e

### 2.1.2.2 Variations

Item-No.	Designation	Description
750-511	2DO 24V DC 0,1 A/ Pulse Width /250 Hz	2-Channel Pulse Width Output Module DC 24 V
750-511/000-002	2DO 24V DC 0,1 A/ Pulse Width /100 Hz	2-Channel Pulse Width Output Module DC 24 V

### 2.1.2.3 Description

The Pulse width output module 750-511 or 750-511/000-002 is able to modulate Signed-Integer values to pulse width modulated 24 V output signals with a constant pulse frequency or periodic time. The On/Off time is given by values of 16 bits.

The module has two output channels and enables the direct wiring of two loads with ground (earth) to the connections DO 1 or DO 2, the common 0 V ground potential and ground (earth), if necessary.

The outputs are short-circuit-protected.

The basic frequency or the period can be parameterized for both channels of the module together. For the module 750-511 the initial pre-programmed base frequency is 250 Hz, for the module 750-511/000-002 it is 100 Hz.



The operational readiness and the trouble-free internal data bus communication of the channels are indicated via a green function LED.

An optocoupler is used for electrical isolation between the bus and the field side.

The field side supply voltage of 24 V for the output module is derived from adjacent I/O modules or from a supply module. The supply voltage for the field side is made automatically through the individual I/O modules by means of power jumper contacts.



### Warning

The maximum current of the internal power jumper contacts is 10 A. When configuring the system it is important not to exceed the maximum/sum current. However, if such a case should occur, another supply module must be added.



### Note

Use an appropriate supply module (e.g. 750-602) if an electrically isolated voltage supply is required!

The specialty module 750-511 and its variations can be used with all couplers/controllers of the WAGO-I/O-SYSTEM 750 (except for the economy types 750-320, -323, -324 and -327).

This description is valid for the XXXX3A04... hardware and software versions. The version is specified in the manufacturing number, which is part of the lateral marking on the module.

## 2.1.2.4 Display Elements

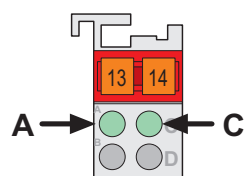

Fig. 2.1.2-2: Display Elements g041402x

LED	Channel	Meaning	State	Function
A green	1	Function DO 1	off	No internal data bus communication.
			on	Internal data bus communication., normal operation
C green	2	Function DO 2	off	No internal data bus communication.
			on	Internal data bus communication., normal operation

2.1.2.5 Schematic Diagram

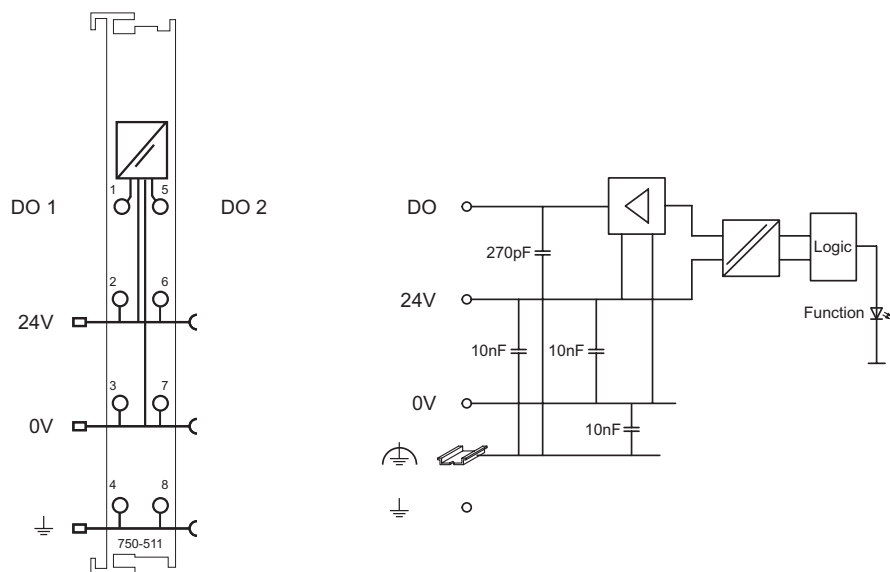





Fig. 2.1.2-3: 2-Channel Pulse Width Output Module 750-511

g051101e

## 2.1.2.6 Technical Data

Module Specific Data		
Number of outputs	2	
Current consumption (internal)	65 mA	
Voltage via power jumper contacts	DC 24 V (-15 % ... +20 %)	
Type of load	resistive, inductive	
Output current	0.1 A short-circuit-protected	
Pulse frequency	250 Hz (750-511) 100 Hz (750-511/000-002)	
Pulse duty factor	0 % ... 100 % (750-511) 0 % ... 100 % (750-511/000-002)	
Resolution	10 bits	
Isolation	500 V (System/Supply)	
Current supply <small>typ.</small> (field side)	6 mA	
Internal bit width	2 x 16 bits data 2 x 8 bits control /status	
Dimensions (mm) W x H x L	12 x 64* x 100 * from upper edge of 35 DIN rail	
Weight	ca. 55 g	
Standards and Regulations (cf. Chapter 2.2 of the Coupler/Controller Manual)		
EMC-Immunity to interference (CE)	acc. to EN 50082-2 (96)	
EMC-Emission of interference (CE)	acc. to EN 50081-1 (93)	
Approvals (cf. Chapter 2.2 of the Coupler/Controller Manual)		
	cUL <sub>US</sub> (UL508)	
	cUL <sub>US</sub> (UL1604)	Class I Div2 ABCD T4A
	KEMA	II 3 G EEx nA II T4
	Conformity Marking	

**More Information**

Detailed references to the approvals are listed in the document "Overview Approvals WAGO-I/O-SYSTEM 750", which you can find on the CD ROM ELECTRONICC Tools and Docs (Item-No.: 0888-0412)

or in the internet under:

[www.wago.com](http://www.wago.com) → Documentation → WAGO-I/O-SYSTEM 750 → System Description

### 2.1.2.7 Process Image

Using the I/O module 750-511 or 750-511/000-002, a 6 byte input and output process image can be transferred to the fieldbus coupler / controller via two logical channels. The setting of the On/Off times occur in the four output bytes (D0, D1) or (D2, D3). The four input bytes (D0, D1, D2, D3) and the status bytes (S0, S1) are not used for the On/Off time settings.



#### Attention

The representation of the process data of some I/O modules or their variations in the process image depends on the fieldbus coupler/-controller used. Please take this information as well as the particular design of the respective control/status bytes from the section "Fieldbus Specific Design of the Process Data" included in the description concerning the process image of the corresponding coupler/controller.

Input data		Output data	
S0	Status byte 0	C0	Control byte 0
D0	X (no evaluation)	D0	On/Off time 1 (low Byte)
D1	X (no evaluation)	D1	On/Off time 1 (high Byte)
S1	Status byte 1	C1	Control byte 1
D2	X (no evaluation)	D2	On/Off time 2 (low Byte)
D3	X (no evaluation)	D3	On/Off time 2 (high Byte)

The programming of the On/Off times occur with the resolution of 10 bits. The five LSB of the 16 bit are not defined. In the table these bits are represented with a 'X'. The indication of the hexadecimal and the decimal numerical values in the table considers the condition '0' for the first five low order bits in each case. If these five bits accept the condition '1', the decimal numerical value is higher around 31, than indicated in the table.

The MSB will hold the sign and is preset to the null state.

750-511, 750-511/000-002				
Pulse duty factor [%]	Units	numerical value		
		binary	hex.	dec.
100,0	1023	'0111.1111.111X.XXXX'	0x7FE0	32736
50,0	511	'0011.1111.111X.XXXX'	0x3FE0	16352
25,0	255	'0001.1111.111X.XXXX'	0x1FE0	8160
0,1955	2	'0000.0000.010X.XXXX'	0x0040	64
0,0977	1	'0000.0000.001X.XXXX'	0x0020	32
0,0	0	'0000.0000.000X.XXXX'	0x0000	0

Control byte 0							
Bit 7	Bit 6	Bit 5	Bit 4	Bit 3	Bit 2	Bit 1	Bit 0
0	0	0	0	0	0	0	0

0 This constant must be set to zero.

Status byte 0							
Bit 7	Bit 6	Bit 5	Bit 4	Bit 3	Bit 2	Bit 1	Bit 0
X	X	X	X	X	X	X	X

X This value is not evaluated.

Control byte 1							
Bit 7	Bit 6	Bit 5	Bit 4	Bit 3	Bit 2	Bit 1	Bit 0
0	0	0	0	0	0	0	0

0 This constant must be set to zero.

Status byte 1							
Bit 7	Bit 6	Bit 5	Bit 4	Bit 3	Bit 2	Bit 1	Bit 0
X	X	X	X	X	X	X	X

X This value is not evaluated.

### 2.1.2.8 Example

The following illustration shows the output signal behavior with different On/Off time settings.

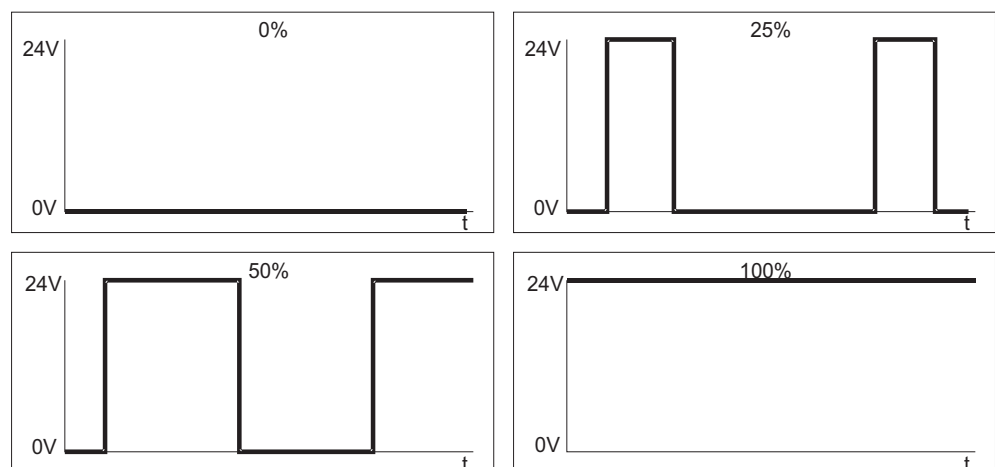

Fig. 2.1.2-4: On/Off time relationships

g051102x

### 2.1.2.9 Parameterizing the Period / Pulse frequency

#### 2.1.2.9.1 Register

Either the period or the basic frequency can be predetermined at any time by the PLC (host) via 2 writeable, non-retentive registers (not protected against voltage loss):

- Register 2: Period (16 bits)
- Register 3: Basic frequency (16 bits).

As soon as the basic frequency has been entered, the period is calculated automatically and entered in register 2.

The modification effects both channels of the bus module.

Default-Value 750-511				
Designation	Register	Value	Resolution	Value Register
Period of oscillation	2	4000 $\mu$ s	1 $\mu$ s / Digit	4000 [0x0FA0]
Pulse frequency	3	250 Hz	1 Hz / Digit	250 [0x00FA]

Default-Value 750-511/000-002				
Designation	Register	Value	Resolution	Value Register
Period of oscillation	2	10000 $\mu$ s	8 $\mu$ s / Digit	1250 [0x04E2]
Pulse frequency	3	100 Hz	1 Hz / Digit	100 [0x0064]

The pulse width bus module loads the default values in the registers after "power-on". The PLC (host) must take this case into account if the required values differ from the default values.

#### 2.1.2.9.2 Control- / Status byte

The PLC can read and set the registers via the control and status byte (C0, S0) and the output bytes (D0, D1) in the process image.

The control byte is transferred from the PLC to the module and the status byte from the module to the PLC.

Control byte 0							
Bit 7	Bit 6	Bit 5	Bit 4	Bit 3	Bit 2	Bit 1	Bit 0
REG	W/R	0	0	0	0	A1	A0

- A0, A1 register address  
 A0 = 0, A1 = 1: register 2  
 A0 = 1, A1 = 1: register 3
- W/R write/read access  
 W/R = 0: read  
 W/R = 1: write
- REG register communication  
 REG = 0: process data communication  
 REG = 1: register communication
- 0 This constant must be set to zero.

Status byte 0							
Bit 7	Bit 6	Bit 5	Bit 4	Bit 3	Bit 2	Bit 1	Bit 0
REG	X	X	X	X	X	A1	A0

A0, A1 register address  
 A0 = 0, A1 = 1: register 2  
 A0 = 1, A1 = 1: register 3

REG register communication  
 REG = 0: process data communication  
 REG = 1: register communication

0 This constant must be set to zero.

The output bytes of channel 1 (D0, D1) are used for the register values.

### 2.1.2.9.3 Example 750-511

The following examples illustrate the register read and write modes. The values are binary. In order to make things easier, only the process data of channel 1 is mentioned.

#### Read register 2

The module is in process data exchange:

Control byte C0	Output byte D1	Output byte D0
'0XXX.XXXX'	'XXXX.XXXX'	'XXXX.XXXX'

Status byte S0	Input byte D1	Input byte D0
'0XXX.XXXX'	'0000.0000'	'0000.0000'

Register read access is available when bit 7 is set and the register address is entered in the control byte.

Control byte C0	Output byte D1	Output byte D0
'1000.0010'	'XXXX.XXXX'	'XXXX.XXXX'

Status byte S0	Input byte D1	Input byte D0	Remark
'0XXX.XXXX'	'XXXX.XXXX'	'XXXX.XXXX'	processing active
'1000.0010'	'0000.1111'	'1010.0000'	value in register 2 e.g. 4000µs (250 Hz) (0x0FA0)

You can reactivate the process data exchange if you erase bit 7.

Control byte C0	Output byte D1	Output byte D0
'0XXX.XXXX'	'XXXX.XXXX'	'XXXX.XXXX'

Status byte S0	Input byte D1	Input byte D0	Remark
'1000.0010'	'0000.1111'	'1010.0000'	acknowledge
'0XXX.XXXX'	'0000.0000'	'0000.0000'	process data exchange

### Write register 2

The module is in process data exchange mode:

Control byte C0	Output byte D1	Output byte D0
'0XXX.XXXX'	'XXXX.XXXX'	'XXXX.XXXX'

Status byte S0	Input byte D1	Input byte D0
'0XXX.XXXX'	'0000.0000'	'0000.0000'

Register write access is available by setting bit 7 and bit 6 and entering the register address in the control byte.

Control byte C0	Output byte D1	Output byte D0	Remark
'1100.0010'	'0000.0100'	'0001.1101'	value in register 2 e.g. 1053µs (950 Hz) (0x041D)

Status byte S0	Input byte D1	Input byte D0	Remark
'0XXX.XXXX'	'XXXX.XXXX'	'XXXX.XXXX'	processing active
'1000.0010'	'0000.0000'	'0000.0000'	acknowledge

You can reactivate the process data exchange if you erase bit 7.

Control byte C0	Output byte D1	Output byte D0
'0XXX.XXXX'	'XXXX.XXXX'	'XXXX.XXXX'

Status byte S0	Input byte D1	Input byte D0	Remark
'1000.0010'	'0000.0000'	'0000.0000'	register-communication (acknowledge)
'0XXX.XXXX'	'0000.0000'	'0000.0000'	process data exchange



### 2.1.2.9.4 Example 750-511/000-002

The following examples illustrate the register read and write modes. The values are binary. In order to make things easier, only the process data of channel 1 is mentioned.

#### Read register 2

The module is in process data exchange:

Control byte C0	Output byte D1	Output byte D0
'0XXX.XXXX'	'XXXX.XXXX'	'XXXX.XXXX'
Status byte S0	Input byte D1	Input byte D0
'0XXX.XXXX'	'0000.0000'	'0000.0000'

Register read access is available when bit 7 is set and the register address is entered in the control byte.

Control byte C0	Output byte D1	Output byte D0	
'1000.0010'	'XXXX.XXXX'	'XXXX.XXXX'	
Status byte S0	Input byte D1	Input byte D0	Remark
'0XXX.XXXX'	'XXXX.XXXX'	'XXXX.XXXX'	processing active
'1000.0010'	'0000.0100'	'1110.0010'	value in register 2 e.g. 10000µs 1250 (0x04E2)

You can reactivate the process data exchange if you erase bit 7.

Control byte C0	Output byte D1	Output byte D0	
'0XXX.XXXX'	'XXXX.XXXX'	'XXXX.XXXX'	
Status byte S0	Input byte D1	Input byte D0	Remark
'1000.0010'	'0000.0100'	'1110.0010'	acknowledge
'0XXX.XXXX'	'0000.0000'	'0000.0000'	process data exchange

### Write register 2

The module is in process data exchange mode:

Control byte C0	Output byte D1	Output byte D0
'0XXX.XXXX'	'XXXX.XXXX'	'XXXX.XXXX'

Status byte S0	Input byte D1	Input byte D0
'0XXX.XXXX'	'0000.0000'	'0000.0000'

Register write access is available by setting bit 7 and bit 6 and entering the register address in the control byte.

Control byte C0	Output byte D1	Output byte D0	Remark
'1100.0010'	'0000.1001'	'1100.0100'	value in register 2 e.g. 20000 $\mu$ s (50 Hz) (0x09C4)

Status byte S0	Input byte D1	Input byte D0	Remark
'0XXX.XXXX'	'XXXX.XXXX'	'XXXX.XXXX'	processing active
'1000.0010'	'0000.0000'	'0000.0000'	acknowledge

You can reactivate the process data exchange if you erase bit 7.

Control byte C0	Output byte D1	Output byte D0
'0XXX.XXXX'	'XXXX.XXXX'	'XXXX.XXXXX'

Status byte S0	Input byte D1	Input byte D0	Remark
'1000.0010'	'0000.0000'	'0000.0000'	register communication (acknowledge)
'0XXX.XXXX'	'0000.0000'	'0000.0000'	process data exchange

## 2.1.3 750-511/000-001 [2DO 24V DC 0,1A/Frequency/2kHz]

2-Channel Pulse Width Output Module DC 24 V

### 2.1.3.1 View

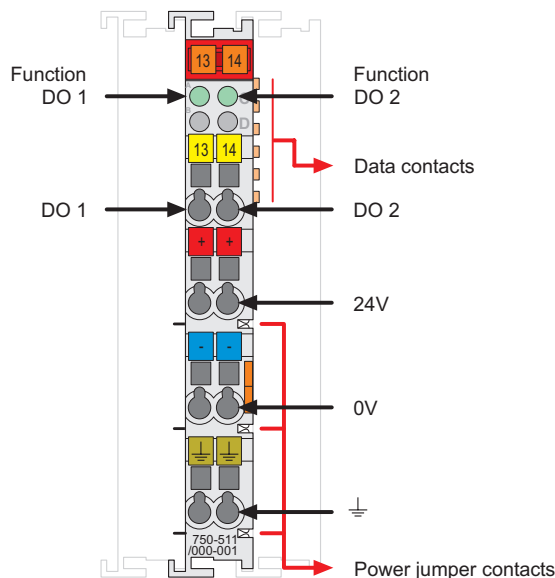

Fig. 2.1.3-1: 2-Channel Pulse Width Output Module 750-511/000-001

g051103e

### 2.1.3.2 Description

The pulse width output module 750-511/000-001 generates a pulse-width-modulated 24 V output signal with a variable frequency from 2 Hz to 2 kHz. The frequency is given by a 10 Bit value with a resolution of 2 Hz per digit. The On/Off ratio is preset by 50%.

The module enables the wiring of a load with pulse and directional signal. The pulse signal and the directional signal are each displayed via one output channel. The direct wiring of loads with ground (earth) is possible to the connections DO 1 (pulse signal) and DO 2 (directional signal), the 0 V ground potential and ground (earth), if necessary.

The outputs are short-circuit-protected.

The operational readiness and the trouble-free internal data bus communication of the channels are indicated via a green function LED.

An optocoupler is used for electrical isolation between the bus and the field side.

The field side supply voltage of 24 V for the output module is derived from adjacent I/O modules or from a supply module. The supply voltage for the field side is made automatically through the individual I/O modules by means of power jumper contacts.



**Warning**

The maximum current of the internal power jumper contacts is 10 A. When configuring the system it is important not to exceed the maximum/sum current. However, if such a case should occur, another supply module must be added.



**Note**

Use an appropriate supply module (e.g. 750-602) if an electrically isolated voltage supply is required!

The special module 750-511/000-001 can be used with all couplers/controllers of the WAGO-I/O-SYSTEM 750 (except for the economy types 750-320, -323, -324 and -327).

This description is valid for the XXXX3A04... hardware and software versions. The version is specified in the manufacturing number, which is part of the lateral marking on the module.

**2.1.3.3 Display Elements**

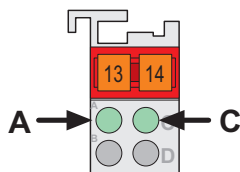

Fig. 2.1.3-2: Display Elements g041402x

LED	Channel	Meaning	State	Function
A green	1	Function DO 1	off	No internal data bus communication.
			on	Internal data bus communication., normal operation
C green	2	Function DO 2	off	No internal data bus communication.
			on	Internal data bus communication., normal operation

2.1.3.4 Schematic Diagram

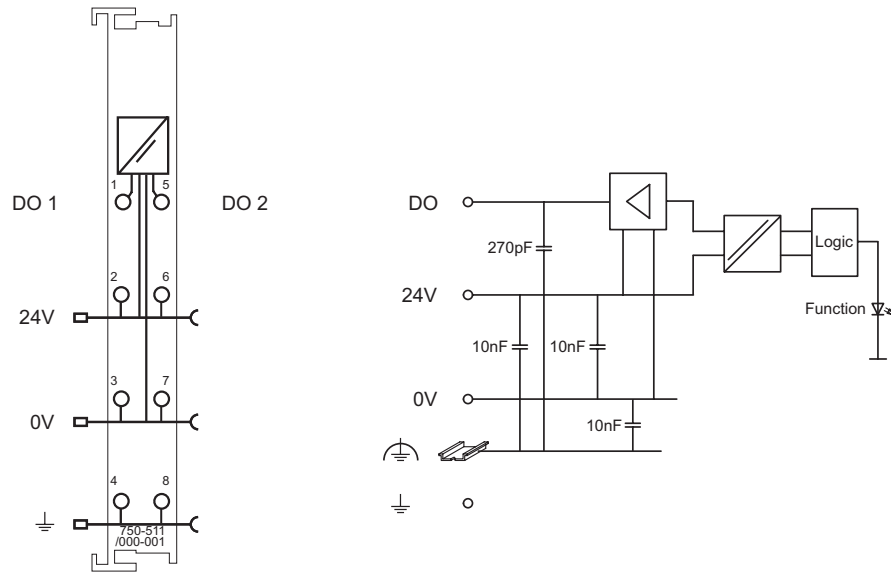





Fig. 2.1.3-3: 2-Channel Pulse Width Output Module 750-511/000-001

g051104e

### 2.1.3.5 Technical Data

Module Specific Data		
Number of outputs	2 (1 x pulse signal, 1 x directional signal)	
Current consumption (internal)	65 mA	
Voltage via power jumper contacts	DC 24 V (-15 % ... +20 %)	
Type of load	resistive, inductive	
Output current	0.1 A short-circuit-protected	
Pulse frequency	2 Hz ... 2 kHz	
Pulse duty factor	50 %	
Resolution	2 Hz	
Isolation	500 V (System/Supply)	
Current supply <sub>typ.</sub> (field side)	6 mA	
Internal bit width	2 x 16 bits data 2 x 8 bits control /status	
Dimensions (mm) W x H x L	12 x 64* x 100 * from upper edge of 35 DIN rail	
Weight	ca. 55 g	
Standards and Regulations (cf. Chapter 2.2 of the Coupler/Controller Manual)		
EMC-Immunity to interference (CE)	acc. to EN 50082-2 (96)	
EMC-Emission of interference (CE)	acc. to EN 50081-1 (93)	
Approvals (cf. Chapter 2.2 of the Coupler/Controller Manual)		
 cUL <sub>US</sub>	cUL <sub>US</sub> (UL508)	
 cUL <sub>US</sub>	cUL <sub>US</sub> (UL1604)	Class I Div2 ABCD T4A
	KEMA	II 3 G EEx nA II T4
	Conformity Marking	



#### More Information

Detailed references to the approvals are listed in the document "Overview Approvals WAGO-I/O-SYSTEM 750", which you can find on the CD ROM ELECTRONICC Tools and Docs (Item-No.: 0888-0412)

or in the internet under:

[www.wago.com](http://www.wago.com) → Documentation → WAGO-I/O-SYSTEM 750 → System Description

### 2.1.3.6 Process Image

Using the I/O module 750-511/000-001, a 6 byte input and output process image can be transferred to the fieldbus coupler / controller via two logical channels.

The setting of the frequency value occurs in the two output bytes (D0, D1) and the counter reading of the pulse counter is given in the two input bytes (D0, D1). The two input bytes (D2, D3) and output bytes (D2, D3) are not used for the frequency value setting. The control byte C0 serves for the setting of the pulse counter. The control byte C and the status bytes (S0, S1) are not used.



#### Attention

The representation of the process data of some I/O modules or their variations in the process image depends on the fieldbus coupler/-controller used. Please take this information as well as the particular design of the respective control/status bytes from the section "Fieldbus Specific Design of the Process Data" included in the description concerning the process image of the corresponding coupler/controller.

Input data		Output data	
S0	Status byte 0	C0	Control byte 0
D0	Pulse counter (low Byte)	D0	Frequency value (low Byte)
D1	Pulse counter (high Byte)	D1	Frequency value (high Byte)
S1	Status byte 1	C1	Control byte 1
D2	X (no evaluation)	D2	0 (reserved)
D3	X (no evaluation)	D3	0 (reserved)

The frequency is set at 2 Hz per digit via the output process image (D0, D1). The impulses are displayed with preset On/Off ratio by 50% on the first output channel DO 1.

In the input process image (D0, D1) the PLC receives back the number of displayed impulses.

The counter direction is set by the sign of the output data (signed integer). The second channel (DO2) indicates the sign.

750-511/000-001			
Output value of the Frequency (Output byte 0, 1) hexadecimal *	Output channel DO1 Frequency [Hz]	Counter direction	Output channel DO2 Status
0x03E8	2000	forward	'1' (DC 24 V)
0x03E7	1998	forward	'1' (DC 24V)
0x01F4	1000	forward	'1' (DC 24 V)
0x0001	2	forward	'1' (DC 24 V)
0x0000	0	—	'0'/'1' **
0xFFFF	2	reverse	'0' (DC 0 V)
0xFFFE	4	reverse	'0' (DC 0 V)
0xFC18	2000	reverse	'0' (DC 0 V)
0xFC17	2002	reverse	'0' (DC 0 V)

\* Permissible range of values for frequency:  
 $0xFC17 \leq \text{Output process data (D0, D1)} \leq 0x03E8$

\*\* The state depends on the counter direction. After power-on the output is 0.

Control byte 0							
Bit 7	Bit 6	Bit 5	Bit 4	Bit 3	Bit 2	Bit 1	Bit 0
0	0	0	0	0	0	0	SET

SET A rising edge of the set bit sets the pulse counter to the value of the current output image.

0 This constant must be set to zero.

Status byte 0							
Bit 7	Bit 6	Bit 5	Bit 4	Bit 3	Bit 2	Bit 1	Bit 0
X	X	X	X	X	X	X	X

X This value is not evaluated.

Control byte 1							
Bit 7	Bit 6	Bit 5	Bit 4	Bit 3	Bit 2	Bit 1	Bit 0
0	0	0	0	0	0	0	0

0 This constant must be set to zero.

Status byte 1							
Bit 7	Bit 6	Bit 5	Bit 4	Bit 3	Bit 2	Bit 1	Bit 0
X	X	X	X	X	X	X	X

X This value is not evaluated.







WAGO Kontakttechnik GmbH & Co. KG  
Postfach 2880 • D-32385 Minden  
Hansastraße 27 • D-32423 Minden  
Phone: 05 71/8 87 – 0  
Fax: 05 71/8 87 – 1 69  
E-Mail: [info@wago.com](mailto:info@wago.com)

Internet: <http://www.wago.com>

---