

30 A high temperature Snubberless™ Triacs

Datasheet - production data

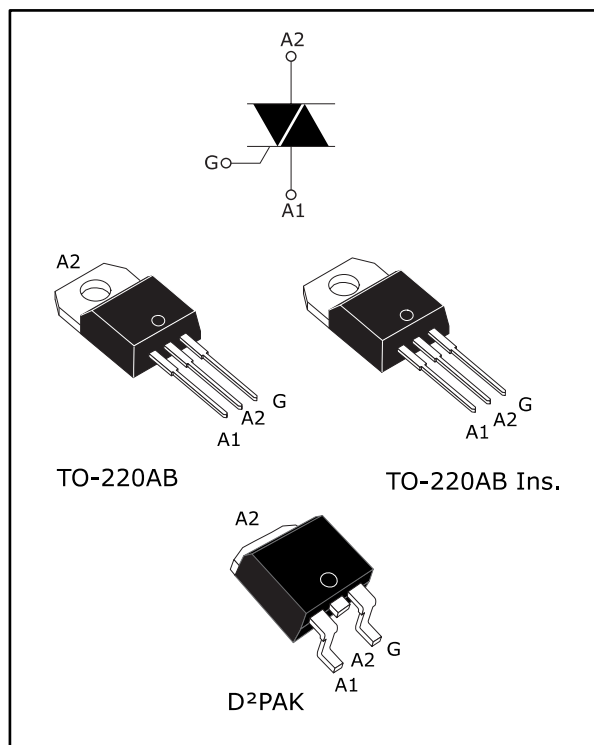

Applications

Thanks to its high electrical noise immunity level and its strong current robustness, the T3035H, T3050H series is designed for the control of AC actuators in appliances and industrial systems.

Description

Specifically designed to operate at 150 °C, the 30 A T3035H, T3050H Triacs provide very high dynamic and enhanced performance in terms of power loss and thermal dissipation. This allows the heatsink size optimization, leading to space and cost effectiveness when compared to electro-mechanical solutions.

Based on ST Snubberless™ technology, they offer a specified minimal commutation and high noise immunity levels valid up to the T_j max.

These devices safely optimize the control of universal motors and of inductive loads found in power tools and major appliances.

By using an internal ceramic pad, they provide voltage insulation (rated at 2500 V_{RMS}).

Features

- High current Triac
- High immunity level
- Low thermal resistance with clip bonding
- Very high 3 quadrant commutation at 150 °C capability
- Packages are RoHS (2002/95/EC) compliant
- UL certified (ref. file E81734)

Table 1: Device summary

Symbol	Value	Unit
$I_{T(RMS)}$	30	A
V_{DRM}/V_{RRM}	600	V
I_{GT}	35 or 50	mA

1 Characteristics

Table 2: Absolute ratings (limiting values)

Symbol	Parameter			Value	Unit
$I_{T(RMS)}$	RMS on-state current (full sine wave)	D ² PAK, TO-220AB	$T_C = 121\text{ °C}$	30	A
		TO-220AB Ins.	$T_C = 92\text{ °C}$		
I_{TSM}	Non repetitive surge peak on-state current (full cycle, T_j initial = 25 °C)	f = 50 Hz	$t_p = 20\text{ ms}$	270	A
		f = 60 Hz	$t_p = 16.7\text{ ms}$	284	
I^2t	I^2t value for fusing		$t_p = 10\text{ ms}$	487	A ² s
di/dt	Critical rate of rise of on-state current $I_G = 2 \times I_{GT}$, $t_r \leq 100\text{ ns}$	f = 120 Hz	$T_j = 150\text{ °C}$	50	A/ μ s
V_{DSM} / V_{RSM}	Non repetitive surge peak off-state voltage	$t_p = 10\text{ ms}$	$T_j = 25\text{ °C}$	$V_{DRM}/V_{RRM} + 100$	V
I_{GM}	Peak forward gate current	$t_p = 20\text{ }\mu$ s	$T_j = 150\text{ °C}$	4	A
$P_{G(AV)}$	Average gate power dissipation		$T_j = 150\text{ °C}$	1	W
T_{stg}	Storage junction temperature range			-40 to +150	°C
T_j	Operating junction temperature range			-40 to +150	°C

Table 3: Electrical characteristics ($T_j = 25\text{ °C}$ unless otherwise specified)

Symbol	Test Conditions	Quadrant		Value		Unit
				T3035H	T3050H	
$I_{GT}^{(1)}$	$V_D = 12\text{ V}$, $R_L = 33\text{ }\Omega$	I - II - III	Max.	35	50	mA
V_{GT}			Max.	1.0		
V_{GD}	$V_D = V_{DRM}$, $R_L = 3.3\text{ k}\Omega$, $T_j = 150\text{ °C}$	I - II - III	Min.	0.15		V
I_H	$I_T = 500\text{ mA}$		Max.	60	75	mA
I_L	$I_G = 1.2 \times I_{GT}$	I - III	Max.	75	90	mA
		II		90	110	
dV/dt ⁽²⁾	$V_D = 2/3 \times V_{DRM}$, gate open	$T_j = 150\text{ °C}$	Min.	1000	1500	V/ μ s
(di/dt) _c ⁽²⁾	Without snubber	$T_j = 150\text{ °C}$	Min.	33	44	A/ms

Notes:

⁽¹⁾minimum I_{GT} is guaranteed at 20% of I_{GT} max.

⁽²⁾for both polarities of A2 referenced to A1.



Table 4: Static characteristics

Symbol	Test conditions			Value	Unit
$V_{TM}^{(1)}$	$I_{TM} = 42 \text{ A}$, $t_p = 380 \text{ } \mu\text{s}$	$T_j = 25 \text{ }^\circ\text{C}$	Max.	1.55	V
$V_{TO}^{(1)}$	Threshold voltage	$T_j = 150 \text{ }^\circ\text{C}$	Max.	0.80	V
$R_d^{(1)}$	Dynamic resistance	$T_j = 150 \text{ }^\circ\text{C}$	Max.	15	m Ω
I_{DRM} / I_{RRM}	$V_{DRM} = V_{RRM}$	$T_j = 25 \text{ }^\circ\text{C}$	Max.	10	μA
		$T_j = 150 \text{ }^\circ\text{C}$	Max.	8.5	mA
	$V_D/V_R = 400 \text{ V}$ (at peak mains voltage)	$T_j = 150 \text{ }^\circ\text{C}$	Max.	7	
	$V_D/V_R = 200 \text{ V}$ (at peak mains voltage)	$T_j = 150 \text{ }^\circ\text{C}$	Max.	5.5	

Notes:

⁽¹⁾for both polarities of A2 referenced to A1

Table 5: Thermal parameters

Symbol	Parameter		Value	Unit
$R_{th(j-c)}$	Junction to case (AC)	D ² PAK, TO-220AB	0.8	$^\circ\text{C/W}$
		TO-220AB Ins.	1.6	
$R_{th(j-a)}$	Junction to ambient ($S_{cu} = 1 \text{ cm}^2$)	D ² PAK	45	
		TO-220AB, TO-220AB Ins.	60	

1.1 Characteristics (curves)

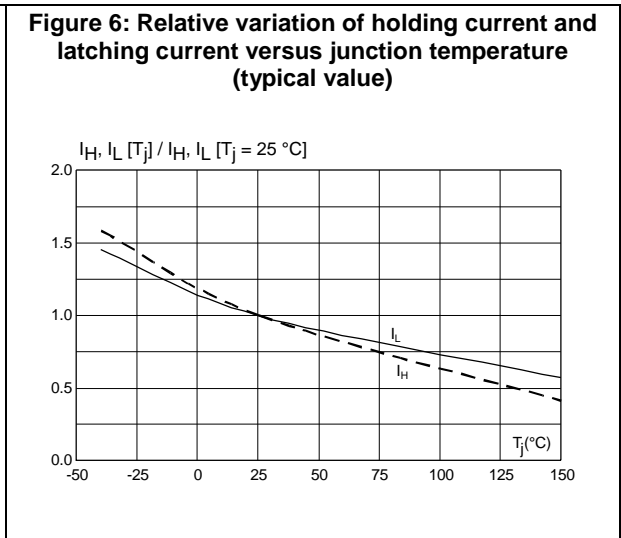
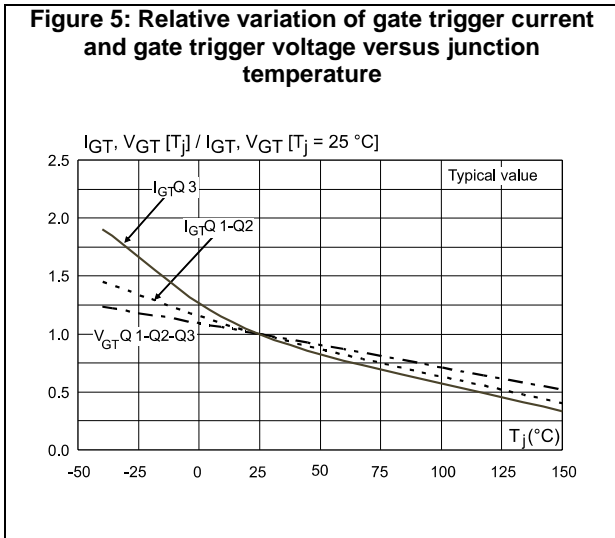
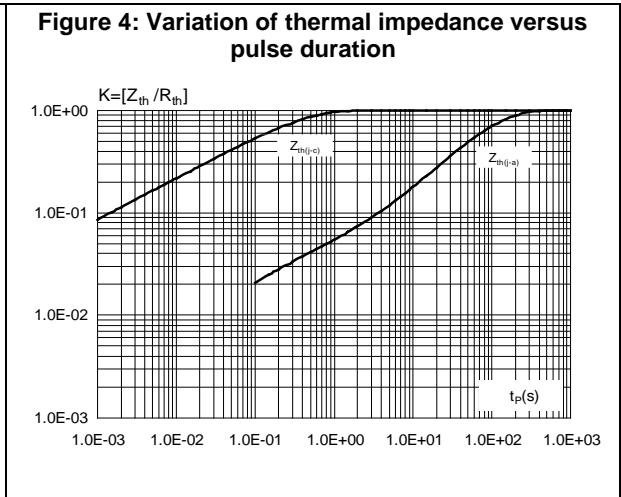
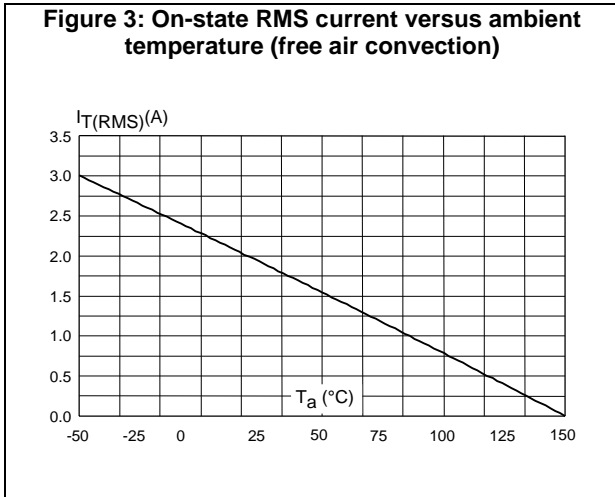
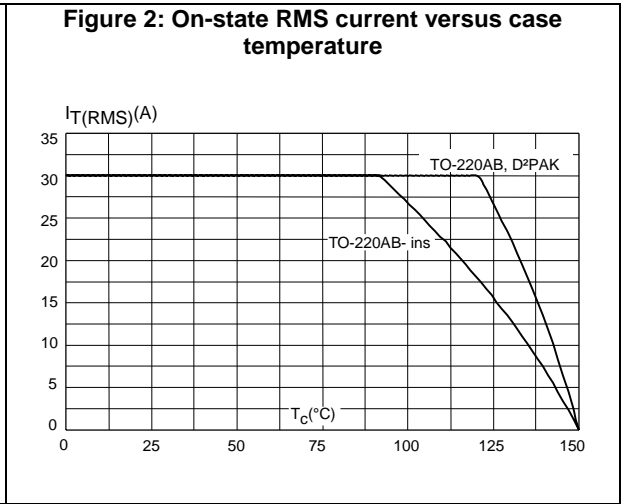
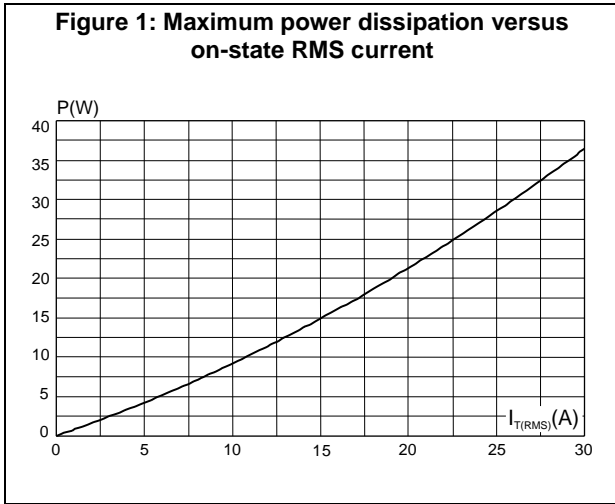

Figure 7: Surge peak on-state current versus number of cycles

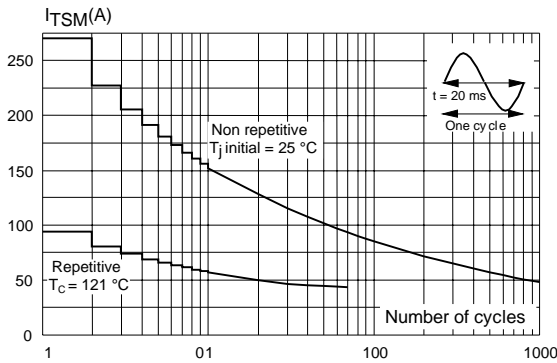

Figure 8: Non repetitive surge peak on-state current for a sinusoidal pulse with width $t_p < 10$ ms

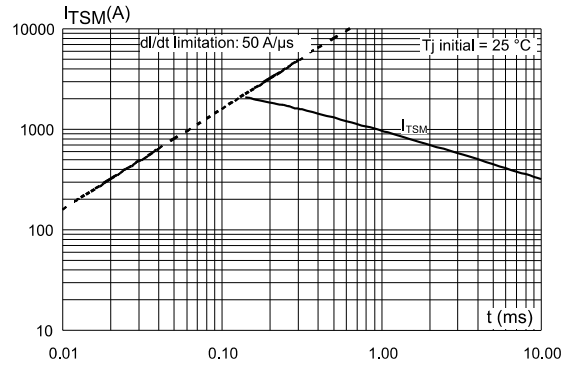

Figure 9: On state characteristics (maximum values)

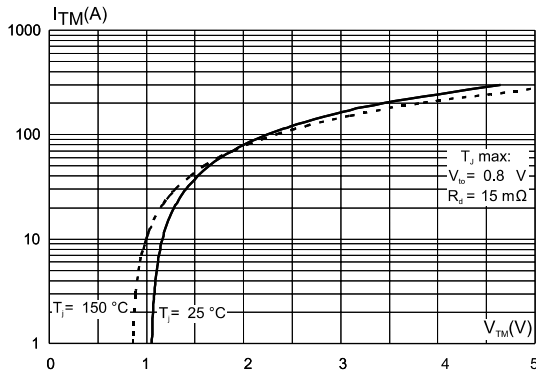

Figure 10: Relative variation of critical rate of decrease of main current versus junction temperature

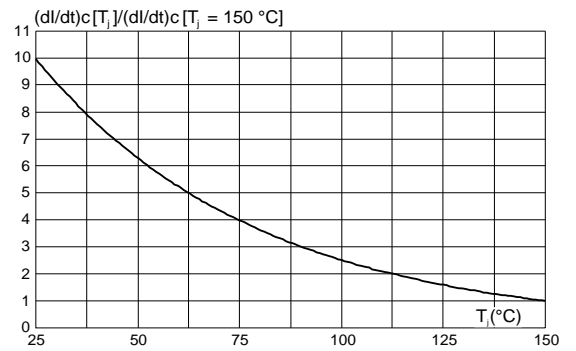

Figure 11: Relative variation of static dV/dt immunity versus junction temperature

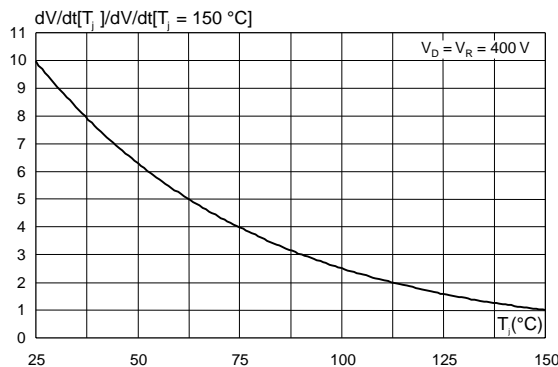

Figure 12: Relative variation of leakage current versus junction temperature for different values of blocking voltage

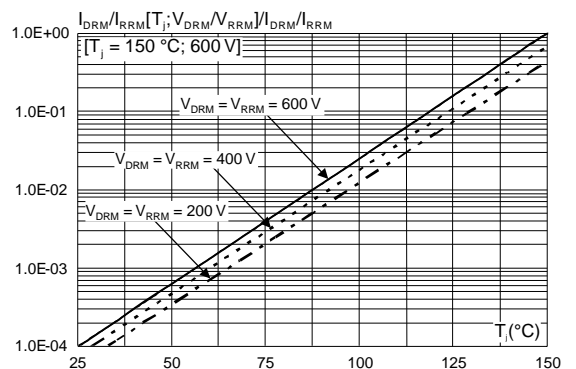

Figure 13: Thermal resistance junction to ambient versus copper surface under tab

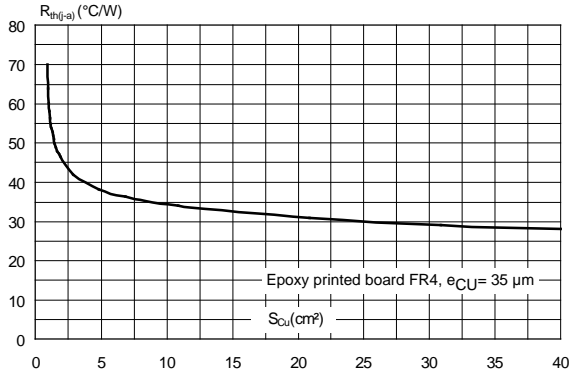
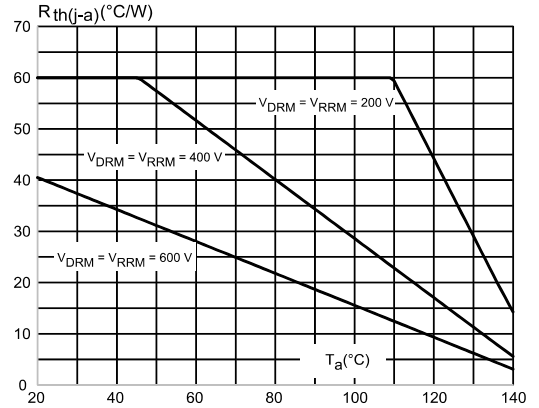

Figure 14: Acceptable junction to ambient thermal resistance versus repetitive peak off-state voltage and ambient temperature



2 Package information

In order to meet environmental requirements, ST offers these devices in different grades of ECOPACK® packages, depending on their level of environmental compliance. ECOPACK® specifications, grade definitions and product status are available at: www.st.com. ECOPACK® is an ST trademark.

- Epoxy meets UL94, V0
- Lead-free package leads
- Cooling method: by conduction (C)

2.1 D²PAK package information

Figure 15: D²PAK package outline

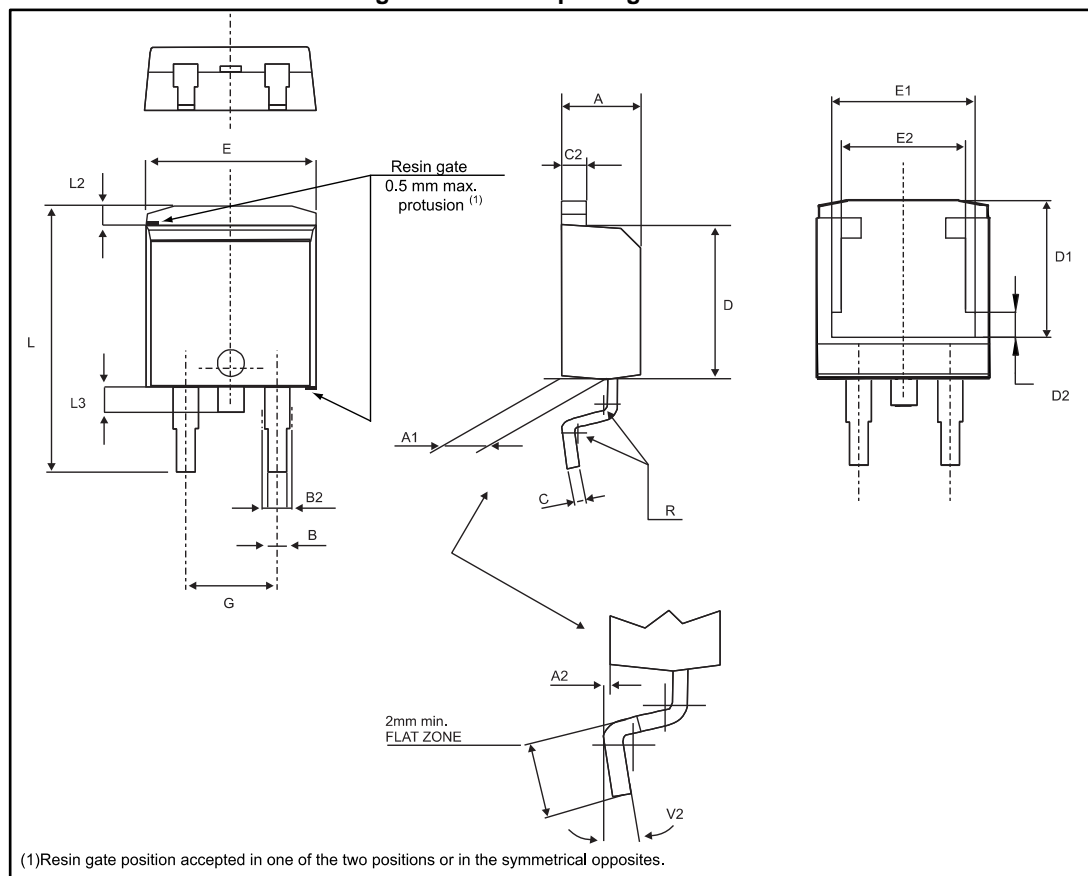

Table 6: D²PAK package mechanical data

Ref.	Dimensions					
	Millimeters			Inches ⁽¹⁾		
	Min.	Typ.	Max.	Min.	Typ.	Max.
A	4.30		4.60	0.1693		0.1811
A1	2.49		2.69	0.0980		0.1059
A2	0.03		0.23	0.0012		0.0091
B	0.70		0.93	0.0276		0.0366
B2	1.25	1.40		0.0492	0.0551	
C	0.45		0.60	0.0177		0.0236
C2	1.21		1.36	0.0476		0.0535
D	8.95		9.35	0.3524		0.3681
D1	7.50		8.00	0.2953		0.3150
D2	1.30		1.70	0.0512		0.0669
E	10.00		10.28	0.3937		0.4047
E1	8.30		8.70	0.3268		0.3425
E2	6.85		7.25	0.2697		0.2854
G	4.88		5.28	0.1921		0.2079
L	15		15.85	0.5906		0.6240
L2	1.27		1.40	0.0500		0.0551
L3	1.40		1.75	0.0551		0.0689
R		0.40			0.0157	
V2	0°		8°	0°		8°

Notes:

⁽¹⁾Dimensions in inches are given for reference only

Figure 16: D²PAK recommended footprint (dimensions are in mm)

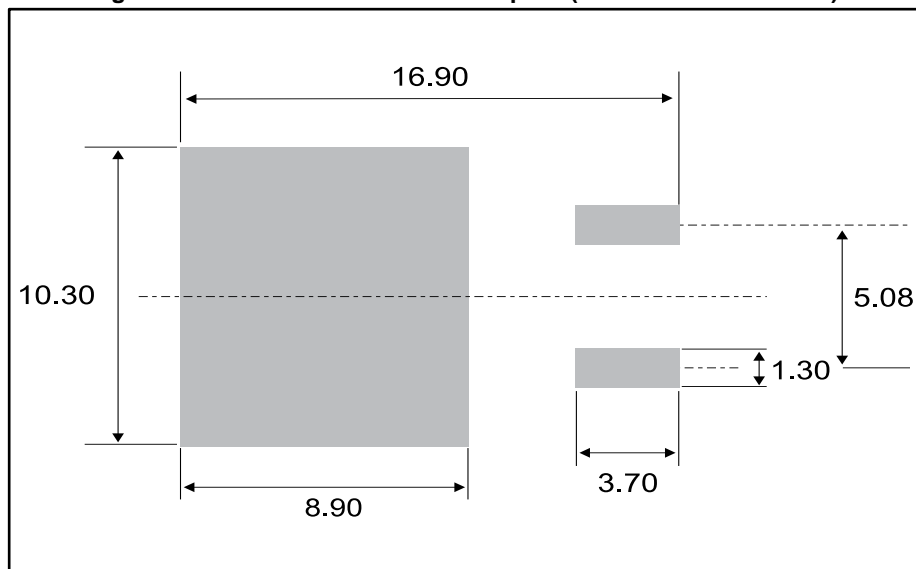

2.2 TO-220AB (NIns. and Ins.) package information

Figure 17: TO-220AB (NIns. and Ins.) package outline

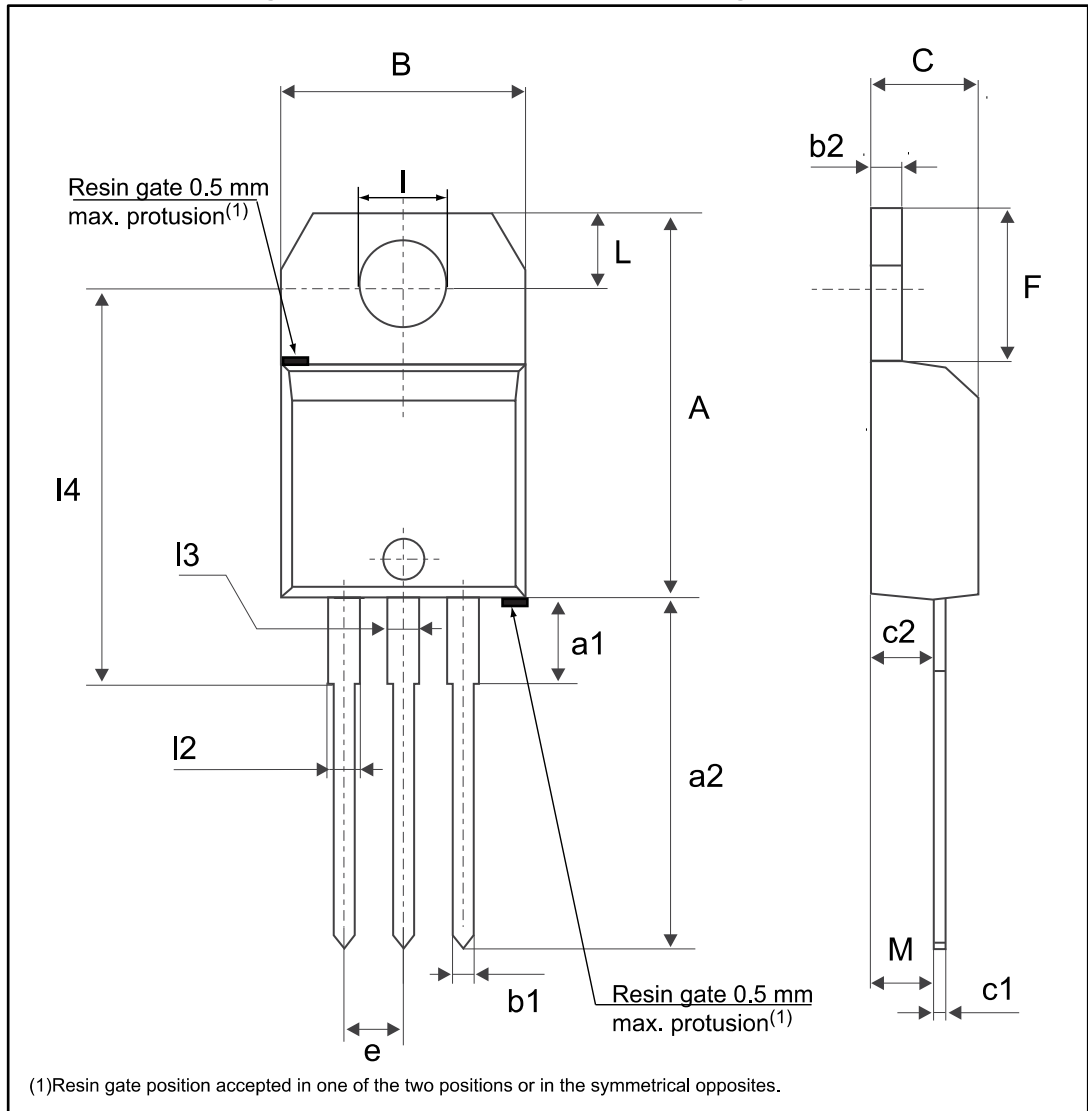

Table 7: TO-220AB (Nlns. and Ins.) package mechanical data

Ref.	Dimensions					
	Millimeters			Inches ⁽¹⁾		
	Min.	Typ.	Max.	Min.	Typ.	Max.
A	15.20		15.90	0.5984		0.6260
a1		3.75			0.1476	
a2	13.00		14.00	0.5118		0.5512
B	10.00		10.40	0.3937		0.4094
b1	0.61		0.88	0.0240		0.0346
b2	1.23		1.32	0.0484		0.0520
C	4.40		4.60	0.1732		0.1811
c1	0.49		0.70	0.0193		0.0276
c2	2.40		2.72	0.0945		0.1071
e	2.40		2.70	0.0945		0.1063
F	6.20		6.60	0.2441		0.2598
I	3.73		3.88	0.1469		0.1528
L	2.65		2.95	0.1043		0.1161
I2	1.14		1.70	0.0449		0.0669
I3	1.14		1.70	0.0449		0.0669
I4	15.80	16.40	16.80	0.6220	0.6457	0.6614
M		2.6			0.1024	

Notes:

⁽¹⁾Inch dimensions are for reference only.

3 Ordering information

Figure 18: Ordering information scheme

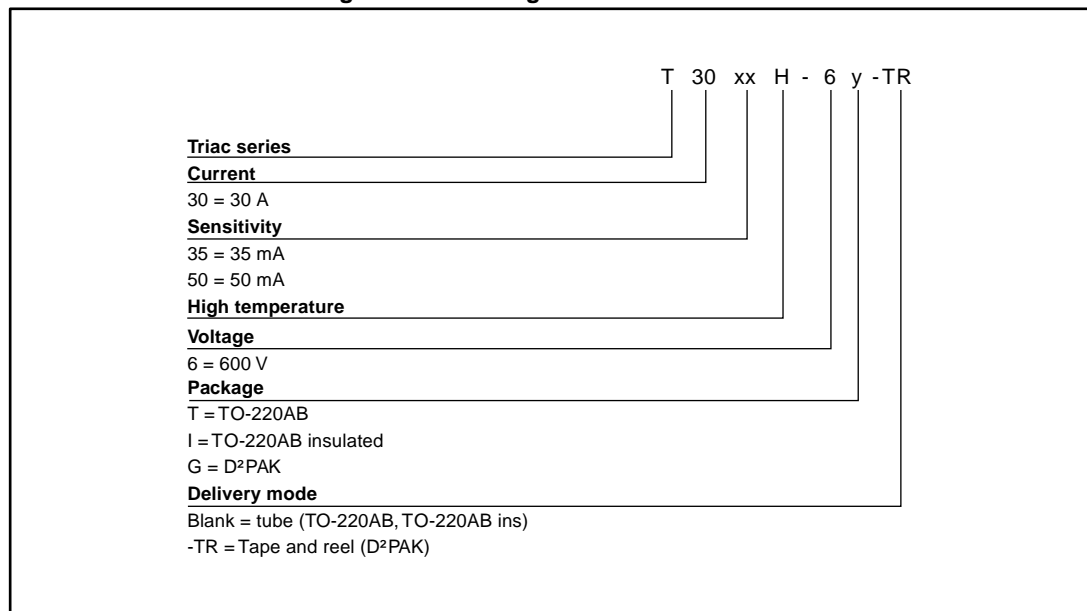

Table 8: Ordering information

Order code	Marking	Package	Weight	Base qty.	Delivery mode
T3035H-6G	T3035H-6G	D ² PAK	1.5 g	50	Tube
T3035H-6G-TR	T3035H-6G			1000	Tape and reel 13"
T3035H-6I	T3035H-6I	TO-220AB Ins.	2.3 g	50	Tube
T3035H-6T	T3035H-6T	TO-220AB	2.3 g	50	Tube
T3050H-6G	T3050H-6G	D ² PAK	1.5 g	50	Tube
T3050H-6G-TR	T3050H-6G			1000	Tape and reel 13"
T3050H-6T	T3050H-6T	TO-220AB	2.3 g	50	Tube

4 Revision history

Table 9: Document revision history

Date	Revision	Changes
28-Jan-2010	1	Initial release.
17-May-2010	2	Updated maximum T_j in Table 2.
14-Dec-2010	3	Updated I_{GT} in Table 1.
20-Sep-2011	4	Updated: <i>Features</i> .
21-Jul-2015	5	Update Table 2 and reformatted to current standard.
20-Jan-2017	6	D ² PAK package added.

IMPORTANT NOTICE – PLEASE READ CAREFULLY

STMicroelectronics NV and its subsidiaries ("ST") reserve the right to make changes, corrections, enhancements, modifications, and improvements to ST products and/or to this document at any time without notice. Purchasers should obtain the latest relevant information on ST products before placing orders. ST products are sold pursuant to ST's terms and conditions of sale in place at the time of order acknowledgement.

Purchasers are solely responsible for the choice, selection, and use of ST products and ST assumes no liability for application assistance or the design of Purchasers' products.

No license, express or implied, to any intellectual property right is granted by ST herein.

Resale of ST products with provisions different from the information set forth herein shall void any warranty granted by ST for such product.

ST and the ST logo are trademarks of ST. All other product or service names are the property of their respective owners.

Information in this document supersedes and replaces information previously supplied in any prior versions of this document.

© 2017 STMicroelectronics – All rights reserved

Mouser Electronics

Authorized Distributor

Click to View Pricing, Inventory, Delivery & Lifecycle Information:

[STMicroelectronics:](#)

[T3035H-6I](#) [T3035H-6T](#) [T3050H-6I](#) [T3050H-6T](#) [T3035H-6G](#) [T3050H-6G-TR](#) [T3050H-6G](#) [T3035H-6G-TR](#)