



## Features

- RoHS compliant\*
- Tight tolerance of bottom electrode width
- 1 % and 5 % tolerance options
- Three layer termination process with nickel barrier helps prevent leaching and provides excellent solderability
- Tape and reel packaging

**BOURNS®**

## CR Series - Thick Film Chip Resistors

### Electrical Characteristics

Characteristic	Model No.							
	CR01005	CR0201	CR0402	CR0603	CR0805	CR1206	CR2010	CR2512
Power Rating @ 70 °C	1/32 W	1/20 W	1/16 W	1/10 W	1/8 W	1/4 W	1/2 W	1 W
Operating Temp. Range	-55 °C to +125 °C			-55 °C to +155 °C				
Derated to Zero Load @	+125 °C			+155 °C				
Max. Working Voltage	15 V	30 V	50 V	75 V	150 V	200 V	200 V	200 V
Max. Overload Voltage	30 V	50 V	100 V	150 V	300 V	400 V	400 V	400 V
Resistance Tolerance	±1 %, ±5 %							
Temperature Coefficient ±1 % (E24 & E96 Series)	10 Ω≤R<100 Ω ±300 ppm/°C	1 Ω≤R<10 Ω -200~+600 ppm/°C	1 Ω≤R<10 Ω -200~+500 ppm/°C	1 Ω≤R<10 Ω ±200 ppm/°C	1 Ω≤R<10 Ω ±200 ppm/°C	1 Ω≤R<10 Ω ±200 ppm/°C	1 Ω≤R<10 Ω ±200 ppm/°C	1 Ω≤R<10 Ω ±200 ppm/°C
	100 Ω≤R<1 MΩ ±200 ppm/°C	10 Ω≤R≤3 MΩ ±200 ppm/°C	10 Ω≤R≤1 MΩ ±100 ppm/°C	10 Ω≤R≤1 MΩ ±100 ppm/°C	10 Ω≤R≤1 MΩ ±100 ppm/°C	10 Ω≤R≤1 MΩ ±100 ppm/°C	10 Ω≤R≤1 MΩ ±100 ppm/°C	10 Ω≤R≤1 MΩ ±100 ppm/°C
			1 MΩ<R≤10 MΩ ±200 ppm/°C	1 MΩ<R≤10 MΩ ±200 ppm/°C	1 MΩ<R≤10 MΩ ±200 ppm/°C	1 MΩ<R≤10 MΩ ±200 ppm/°C	1 MΩ<R≤10 MΩ ±200 ppm/°C	1 MΩ<R≤10 MΩ ±200 ppm/°C
Temperature Coefficient ±5 % (E24 Series)	10 Ω≤R<100 Ω ±300 ppm/°C	1 Ω≤R<10 Ω -200~+600 ppm/°C	1 Ω≤R<10 Ω -200~+500 ppm/°C	1 Ω≤R<10 Ω ±400 ppm/°C	1 Ω≤R<10 Ω ±400 ppm/°C	1 Ω≤R<10 Ω ±400 ppm/°C	1 Ω≤R<10 Ω ±400 ppm/°C	1 Ω≤R<10 Ω ±400 ppm/°C
	100 Ω≤R≤1 MΩ ±200 ppm/°C	10 Ω≤R≤10 MΩ ±200 ppm/°C	10 Ω≤R≤10 MΩ ±200 ppm/°C	10 Ω≤R≤10 MΩ ±200 ppm/°C	10 Ω≤R≤10 MΩ ±200 ppm/°C	10 Ω≤R≤10 MΩ ±200 ppm/°C	10 Ω≤R≤10 MΩ ±200 ppm/°C	10 Ω≤R≤10 MΩ ±200 ppm/°C
			10 MΩ<R≤20 MΩ ±400 ppm/°C	10 MΩ<R≤20 MΩ ±400 ppm/°C	10 MΩ<R≤20 MΩ ±400 ppm/°C	10 MΩ<R≤20 MΩ ±400 ppm/°C	10 MΩ<R≤20 MΩ ±400 ppm/°C	10 MΩ<R≤20 MΩ ±400 ppm/°C
Zero Ohm Jumper	50 milliohms max.							
Rated Current	0.5 A		1 A			2 A		
Max. Overload Current	1 A		2.5 A			5 A		

### Environmental Characteristics

Moisture Sensitivity Level..... 1



**WARNING Cancer and Reproductive Harm - [www.P65Warnings.ca.gov](http://www.P65Warnings.ca.gov)**

\* RoHS Directive 2015/863, Mar 31, 2015 and Annex.

Specifications are subject to change without notice.

Users should verify actual device performance in their specific applications.

The products described herein and this document are subject to specific legal disclaimers as set forth on the last page of this document, and at [www.bourns.com/docs/legal/disclaimer.pdf](http://www.bourns.com/docs/legal/disclaimer.pdf).

**BOURNS®**

Asia-Pacific: Tel: +886-2 2562-4117 • Email: [asiacus@bourns.com](mailto:asiacus@bourns.com)

EMEA: Tel: +36 88 885 877 • Email: [eurocus@bourns.com](mailto:eurocus@bourns.com)

The Americas: Tel: +1-951 781-5500 • Email: [americus@bourns.com](mailto:americus@bourns.com)

[www.bourns.com](http://www.bourns.com)

# CR Series - Thick Film Chip Resistors

**BOURNS®**

## Product Dimensions

Model	L	W	C	D	T
CR01005	$\frac{0.40 \pm 0.02}{(.016 \pm .0008)}$	$\frac{0.20 \pm 0.03}{(.008 \pm .001)}$	$\frac{0.10 \pm 0.03}{(.004 \pm .001)}$	$\frac{0.10 \pm 0.03}{(.004 \pm .001)}$	$\frac{0.13 \pm 0.02}{(.009 \pm .0008)}$
CR0201	$\frac{0.60 \pm 0.03}{(.024 \pm .001)}$	$\frac{0.30 \pm 0.03}{(.012 \pm .001)}$	$\frac{0.10 \pm 0.05}{(.004 \pm .002)}$	$\frac{0.15 \pm 0.05}{(.006 \pm .002)}$	$\frac{0.23 \pm 0.03}{(.009 \pm .001)}$
CR0402	$\frac{1.00 \pm 0.05}{(.039 \pm .002)}$	$\frac{0.50 \pm 0.05}{(.020 \pm .002)}$	$\frac{0.20 \pm 0.10}{(.008 \pm .004)}$	$\frac{0.25 \pm 0.10}{(.010 \pm .004)}$	$\frac{0.32 \pm 0.05}{(.013 \pm .002)}$
CR0603	$\frac{1.60 \pm 0.10}{(.063 \pm .004)}$	$\frac{0.80 \pm 0.10}{(.031 \pm .004)}$	$\frac{0.30 \pm 0.20}{(.012 \pm .008)}$	$\frac{0.30 \pm 0.20}{(.012 \pm .008)}$	$\frac{0.45 \pm 0.10}{(.018 \pm .004)}$
CR0805	$\frac{2.00 \pm 0.10}{(.079 \pm .004)}$	$\frac{1.25 \pm 0.10}{(.049 \pm .004)}$	$\frac{0.40 \pm 0.20}{(.016 \pm .008)}$	$\frac{0.40 \pm 0.20}{(.016 \pm .008)}$	$\frac{0.50 \pm 0.10}{(.020 \pm .004)}$
CR1206	$\frac{3.10 \pm 0.10}{(.122 \pm .004)}$	$\frac{1.55 \pm 0.10}{(.061 \pm .004)}$	$\frac{0.50 \pm 0.30}{(.020 \pm .012)}$	$\frac{0.40 \pm 0.20}{(.016 \pm .008)}$	$\frac{0.55 \pm 0.10}{(.022 \pm .004)}$
CR2010	$\frac{5.00 \pm 0.15}{(.197 \pm .006)}$	$\frac{2.50 \pm 0.15}{(.098 \pm .006)}$	$\frac{0.60 \pm 0.30}{(.024 \pm .012)}$	$\frac{0.50 \pm 0.25}{(.020 \pm .010)}$	$\frac{0.60 \pm 0.10}{(.024 \pm .004)}$
CR2512	$\frac{6.30 \pm 0.20}{(.248 \pm .008)}$	$\frac{3.20 \pm 0.20}{(.126 \pm .008)}$	$\frac{0.60 \pm 0.30}{(.024 \pm .012)}$	$\frac{0.50 \pm 0.25}{(.020 \pm .010)}$	$\frac{0.60 \pm 0.10}{(.024 \pm .004)}$

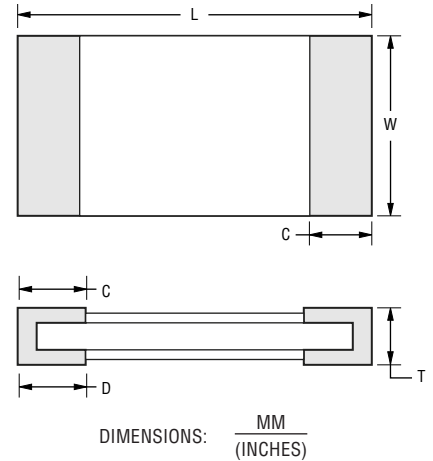

## Recommended Pad Layout

Model	a	b	c
CR01005	$\frac{0.15 \sim 0.20}{(.006 \sim .008)}$	$\frac{0.50 \sim 0.70}{(.020 \sim .028)}$	$\frac{0.20 \sim 0.25}{(.008 \sim .010)}$
CR0201	$\frac{0.25 \sim 0.30}{(.010 \sim .012)}$	$\frac{0.70 \sim 0.90}{(.028 \sim .035)}$	$\frac{0.30 \sim 0.40}{(.012 \sim .016)}$
CR0402	$\frac{0.50 \sim 0.60}{(.020 \sim .024)}$	$\frac{1.40 \sim 1.60}{(.055 \sim .063)}$	$\frac{0.40 \sim 0.60}{(.012 \sim .024)}$
CR0603	$\frac{0.70 \sim 0.90}{(.028 \sim .035)}$	$\frac{2.00 \sim 2.20}{(.079 \sim .087)}$	$\frac{0.80 \sim 1.00}{(.031 \sim .039)}$
CR0805	$\frac{1.00 \sim 1.40}{(.039 \sim .055)}$	$\frac{3.20 \sim 3.80}{(.126 \sim .150)}$	$\frac{0.90 \sim 1.40}{(.035 \sim .055)}$
CR1206	$\frac{2.00 \sim 2.40}{(.079 \sim .094)}$	$\frac{4.40 \sim 5.00}{(.173 \sim .197)}$	$\frac{1.20 \sim 1.80}{(.047 \sim .071)}$
CR2010	$\frac{3.30 \sim 3.70}{(.130 \sim .146)}$	$\frac{5.70 \sim 6.50}{(.224 \sim .256)}$	$\frac{2.30 \sim 3.50}{(.091 \sim .138)}$
CR2512	$\frac{3.60 \sim 4.00}{(.142 \sim .157)}$	$\frac{7.60 \sim 8.60}{(.299 \sim .339)}$	$\frac{2.30 \sim 3.50}{(.091 \sim .138)}$

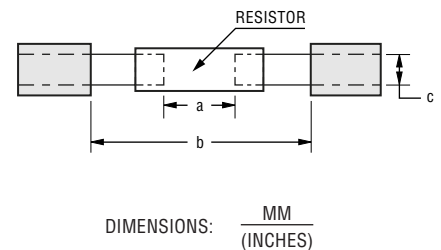

Specifications are subject to change without notice.

Users should verify actual device performance in their specific applications.

The products described herein and this document are subject to specific legal disclaimers as set forth on the last page of this document, and at [www.bourns.com/docs/legal/disclaimer.pdf](http://www.bourns.com/docs/legal/disclaimer.pdf).

# CR Series - Thick Film Chip Resistors

**BOURNS®**

## Soldering Profile

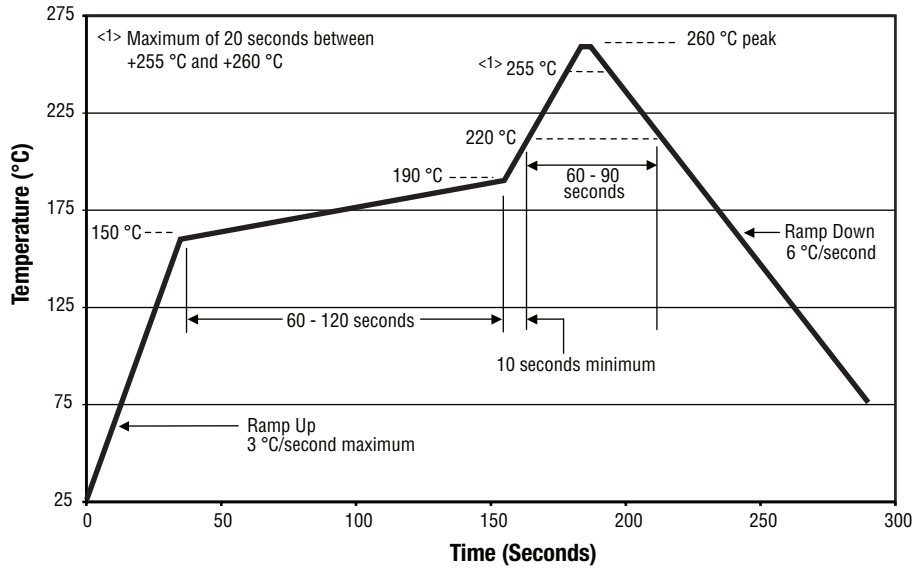

## Derating Curve

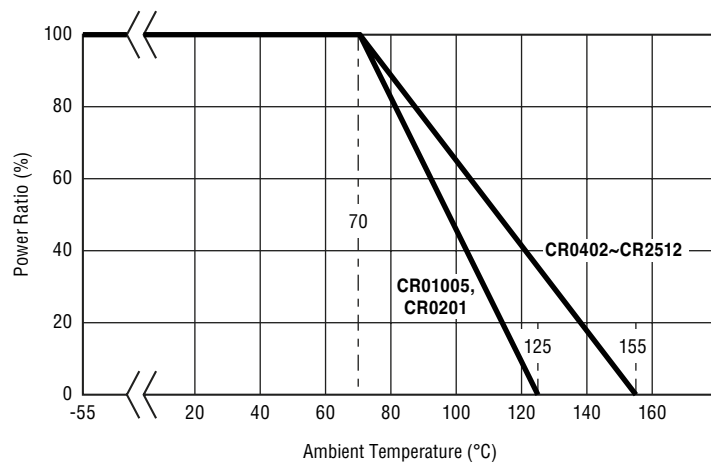

Specifications are subject to change without notice.

Users should verify actual device performance in their specific applications.

The products described herein and this document are subject to specific legal disclaimers as set forth on the last page of this document, and at [www.bourns.com/docs/legal/disclaimer.pdf](http://www.bourns.com/docs/legal/disclaimer.pdf).

## Performance Characteristics

Test	Procedure (IEC 60115-1)	Test Limits $\Delta R$
Short Time Overload	2.5 x rated voltage for 5 seconds	$\leq \pm (1 \% + 0.05 \Omega)$ <i>Remarks:</i> CR01005, CR0201 ..... $\pm (3 \% + 0.1 \Omega)$ CR0402 ..... $\pm (2 \% + 0.1 \Omega)$ 0 $\Omega$ Jumper ..... 50 m $\Omega$ or less
Intermittent Overload	3.0 x rated voltage or max. overloading voltage, 1 sec. "ON", 25 sec. "OFF", 10,000 cycles <i>Remarks:</i> CR01005, CR0201 ..... not applicable CR0402 ..... 2.5 x rated continuous working voltage	1 %: $\leq \pm (1 \% + 0.05 \Omega)$ 5 %: $\leq \pm (3 \% + 0.1 \Omega)$ <i>Remarks:</i> CR01005, CR0201 ..... $\pm (5 \% + 0.1 \Omega)$ CR0402 ..... $\pm (3 \% + 0.1 \Omega)$ 0 $\Omega$ Jumper ..... 100 m $\Omega$ or less
Load Life	1000 hours at rated voltage, 70 °C, 1.5 hours "ON", 0.5 hour "OFF"	1 %: $\leq \pm (1 \% + 0.05 \Omega)$ 5 %: $\leq \pm (3 \% + 0.1 \Omega)$ <i>Remarks:</i> CR01005, CR0201 ..... $\pm (5 \% + 0.1 \Omega)$ CR0402 ..... $\pm (3 \% + 0.1 \Omega)$ 0 $\Omega$ Jumper ..... 100 m $\Omega$ or less
Load Life Humidity	1000 hours at rated voltage, 40 $\pm$ 2 °C, 90~95 % RH 1.5 hours "ON", 0.5 hour "OFF"	1 %: $\leq \pm (1 \% + 0.05 \Omega)$ 5 %: $\leq \pm (3 \% + 0.1 \Omega)$ <i>Remarks:</i> CR01005, CR0201 ..... $\pm (5 \% + 0.1 \Omega)$ CR0402 ..... $\pm (3 \% + 0.1 \Omega)$ 0 $\Omega$ Jumper ..... 100 m $\Omega$ or less
Rapid Change of Temperature	-55 °C (30 min.) / +155 °C (30 min.) 5 cycles	1 %: $\leq \pm (0.5 \% + 0.05 \Omega)$ 5 %: $\leq \pm (1 \% + 0.05 \Omega)$ <i>Remarks:</i> CR01005, CR0201 ..... $\pm (3 \% + 0.1 \Omega)$ 0 $\Omega$ Jumper ..... 50 m $\Omega$ or less
Resistance to Solder Heat	270 $\pm$ 5 °C, 10 $\pm$ 1 sec.	1 %: $\leq \pm (0.5 \% + 0.05 \Omega)$ 5 %: $\leq \pm (1 \% + 0.05 \Omega)$ <i>Remarks:</i> CR01005 ..... $\pm (3 \% + 0.05 \Omega)$ CR0201 ..... $\pm (3 \% + 0.1 \Omega)$ 0 $\Omega$ Jumper ..... 50 m $\Omega$ or less
Solderability	245 $\pm$ 5 °C solder, 2 $\pm$ 0.5 seconds dwell Solder: Sn96.5 / Ag3.0 / Cu0.5	Over 95 % of termination must be covered with solder
Resistance to Dry Heat	155 $\pm$ 5 °C for 96 $\pm$ 4 hours <i>Remarks:</i> CR0201 ..... 125 $\pm$ 5 °C	1 %: $\leq \pm (1 \% + 0.05 \Omega)$ 5 %: $\leq \pm (1 \% + 0.05 \Omega)$ <i>Remarks:</i> CR01005, CR0201 ..... $\pm (1 \% + 0.1 \Omega)$ 0 $\Omega$ Jumper ..... 50 m $\Omega$ or less
Bending	3 mm deflection <i>Remarks:</i> CR2010, CR2512 ..... 2 mm deflection	1 %: $\leq \pm (0.5 \% + 0.05 \Omega)$ 5 %: $\leq \pm (2 \% + 0.1 \Omega)$ <i>Remarks:</i> CR01005, CR0201 ..... $\pm (3 \% + 0.1 \Omega)$ CR0402 ..... $\pm (2 \% + 0.1 \Omega)$ 0 $\Omega$ Jumper ..... 50 m $\Omega$ or less
Dielectric Withstanding Voltage	500 V, 1 minute <i>Remarks:</i> CR01005, CR0201 ..... 50 V CR0402 ..... 300 V	No abnormalities such as flashover, burning or dielectric breakdown shall appear
Insulation Resistance	100 V, 1 minute <i>Remarks:</i> CR0201 ..... 50 V	$\geq 1$ G $\Omega$ <i>Remarks:</i> CR01005 ..... $\geq 100$ M $\Omega$ )

Specifications are subject to change without notice. Users should verify actual device performance in their specific applications.

The products described herein and this document are subject to specific legal disclaimers as set forth on the last page of this document, and at [www.bourns.com/docs/legal/disclaimer.pdf](http://www.bourns.com/docs/legal/disclaimer.pdf).

# CR Series - Thick Film Chip Resistors

**BOURNS®**

## How to Order

CR 1206 - F X - 1003 E LF

### Model

(CR = Chip Resistor)

### Size

01005 = 01005 size  
0201 = 0201 size  
0402 = 0402 size  
0603 = 0603 size  
0805 = 0805 size  
1206 = 1206 size  
2010 = 2010 size  
2512 = 2512 size

### Resistance Tolerance

F =  $\pm 1\%$   
J =  $\pm 5\%$

### TCR (ppm/°C) – See Electrical Characteristics Chart

X =  $\pm 100$   
W =  $\pm 200$   
V =  $\pm 300$   
Z =  $\pm 400$   
/ = Used for zero  $\Omega$  (jumper) and values from 1  $\Omega$  through 9.76  $\Omega$ .

### Resistance Value

#### For 1 % Tolerance:

<100  $\Omega$  ..... "R" represents decimal point (example: 24R3 = 24.3  $\Omega$ ).

$\geq 100 \Omega$  ..... First three digits are significant, fourth digit represents number of zeros to follow (example: 8252 = 82.5K  $\Omega$ ).

#### For 5 % Tolerance:

<10  $\Omega$  ..... "R" represents decimal point (example: 4R7 = 4.7  $\Omega$ ).

$\geq 10 \Omega$  ..... First two digits are significant, third digit represents number of zeros to follow (example: 474 = 470K  $\Omega$ ; 000 = Jumper).

### Packaging

G = Paper Tape (10,000 pcs.) on 7-inch Plastic Reel – CR01005, CR0201, CR0402  
E = Paper Tape (5,000 pcs.) on 7-inch Plastic Reel – CR0603, CR0805, CR1206 or  
Embossed Tape (4,000 pcs) on 7-inch Plastic Reel – CR2010, CR2512

### Termination

LF = Tin-plated (RoHS Compliant)

Specifications are subject to change without notice.

Users should verify actual device performance in their specific applications.

The products described herein and this document are subject to specific legal disclaimers as set forth on the last page of this document, and at [www.bourns.com/docs/legal/disclaimer.pdf](http://www.bourns.com/docs/legal/disclaimer.pdf).

# CR Series - Thick Film Chip Resistors

**BOURNS®**

## EIA-96 Marking for CR0603, 1 %

Code	R Value	Code	R Value	Code	R Value	Code	R Value
01	100	25	178	49	316	73	562
02	102	26	182	50	324	74	576
03	105	27	187	51	332	75	590
04	107	28	191	52	340	76	604
05	110	29	196	53	348	77	619
06	113	30	200	54	357	78	634
07	115	31	205	55	365	79	649
08	118	32	210	56	374	80	665
09	121	33	215	57	383	81	681
10	124	34	221	58	392	82	698
11	127	35	226	59	402	83	715
12	130	36	232	60	412	84	732
13	133	37	237	61	422	85	750
14	137	38	243	62	432	86	768
15	140	39	249	63	442	87	787
16	143	40	255	64	453	88	806
17	147	41	261	65	464	89	825
18	150	42	267	66	475	90	845
19	154	43	274	67	487	91	866
20	158	44	280	68	499	92	887
21	162	45	287	69	511	93	909
22	165	46	294	70	523	94	931
23	169	47	301	71	536	95	953
24	174	48	309	72	549	96	976

## Multipliers

Code	A	B	C	D	E	F	G	H	X	Y	Z
Multiplier	10 <sup>0</sup>	10 <sup>1</sup>	10 <sup>2</sup>	10 <sup>3</sup>	10 <sup>4</sup>	10 <sup>5</sup>	10 <sup>6</sup>	10 <sup>7</sup>	10 <sup>-1</sup>	10 <sup>-2</sup>	10 <sup>-3</sup>

## Marking Explanation

0Ω JUMPER:



CR01005, CR0201,  
CR0402:  
No marking.



CR0603, CR0805, CR1206,  
CR2010, CR2512:

- E-24: 3 digits; first two digits are significant, third digit is number of zeros to follow.  
Letter R is decimal point.



(Value = 10K Ω)

- E-96: 4 digits; first three digits are significant, fourth digit is number of zeros to follow.  
Letter R is decimal point.

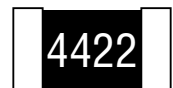

(Value = 44.2K Ω)

- CR0603 E-96: EIA-96 marking (see table).



(Value = 12.4K Ω)

Specifications are subject to change without notice.

Users should verify actual device performance in their specific applications.

The products described herein and this document are subject to specific legal disclaimers as set forth on the last page of this document, and at [www.bourns.com/docs/legal/disclaimer.pdf](http://www.bourns.com/docs/legal/disclaimer.pdf).

# CR Series - Thick Film Chip Resistors

**BOURNS®**

## Packaging Dimensions (Conforms to EIA RS-481A)

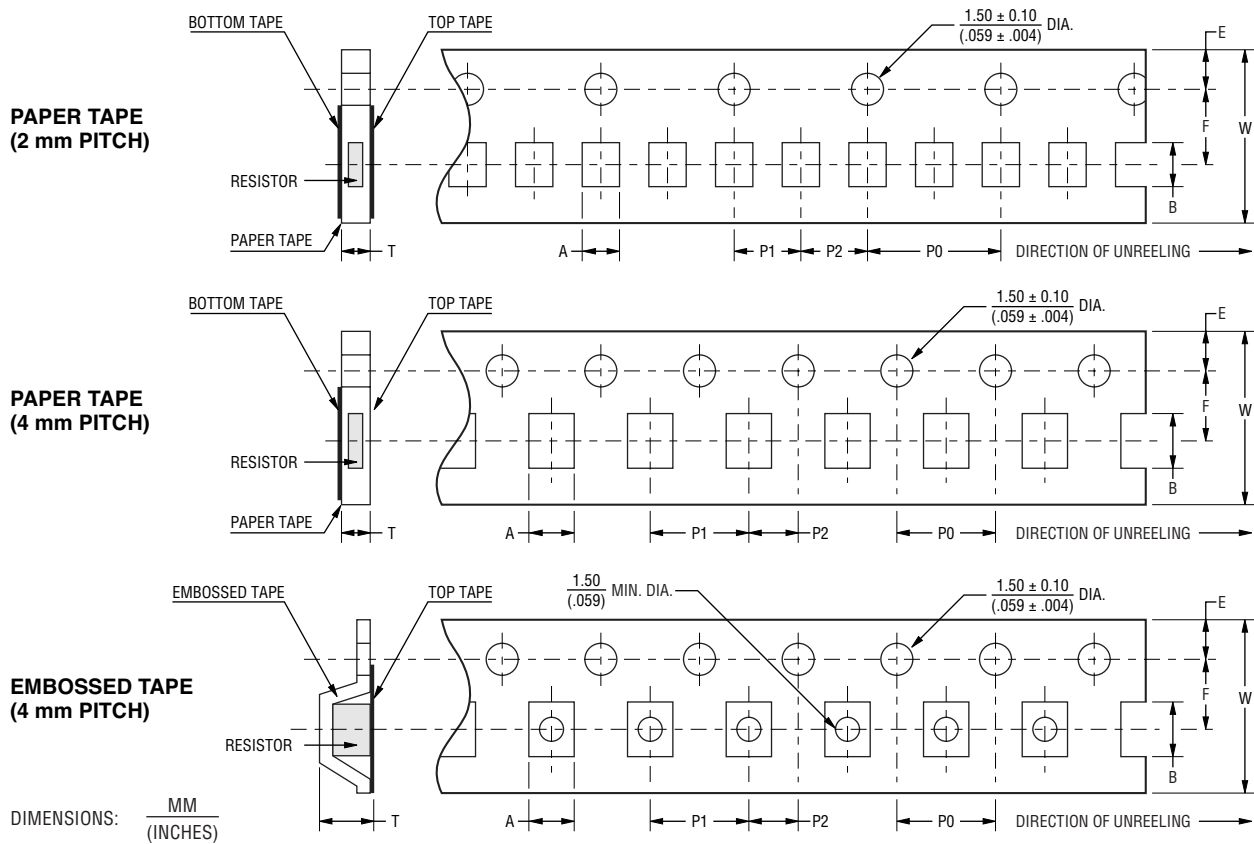

Model	Tape Type	A	B	W	F	E	P1	P2	P0	T
CR01005	Paper Tape (2 mm pitch)	$\frac{0.24 \pm 0.05}{(.010 \pm .002)}$	$\frac{0.45 \pm 0.10}{(.018 \pm .004)}$	$\frac{8.00 \pm 0.20}{(.315 \pm .008)}$	$\frac{3.50 \pm 0.05}{(.138 \pm .002)}$	$\frac{1.75 \pm 0.10}{(.069 \pm .004)}$	$\frac{4.00 \pm 0.10}{(.157 \pm .004)}$	$\frac{2.00 \pm 0.05}{(.079 \pm .002)}$	$\frac{4.00 \pm 0.10}{(.157 \pm .004)}$	$\frac{0.15 \pm 0.10}{(.006 \pm .004)}$
CR0201	Paper Tape (2 mm pitch)	$\frac{0.37 \pm 0.05}{(.014 \pm .002)}$	$\frac{0.67 \pm 0.10}{(.026 \pm .004)}$							$\frac{0.37 \pm 0.10}{(.015 \pm .004)}$
CR0402		$\frac{0.70 \pm 0.05}{(.028 \pm .002)}$	$\frac{1.20 \pm 0.05}{(.047 \pm .002)}$							$\frac{0.45 \pm 0.10}{(.018 \pm .004)}$
CR0603	Paper Tape (4 mm pitch)	$\frac{1.10 \pm 0.10}{(.043 \pm .004)}$	$\frac{1.90 \pm 0.10}{(.075 \pm .004)}$	$\frac{0.64 \pm 0.10}{(.025 \pm .004)}$						
CR0805		$\frac{1.60 \pm 0.15}{(.063 \pm .006)}$	$\frac{2.40 \pm 0.20}{(.094 \pm .008)}$	$\frac{0.84 \pm 0.10}{(.033 \pm .004)}$						
CR1206		$\frac{2.00 \pm 0.15}{(.079 \pm .006)}$	$\frac{3.60 \pm 0.20}{(.142 \pm .008)}$	$\frac{0.84 \pm 0.10}{(.033 \pm .004)}$						
CR2010	Embossed Tape (4 mm pitch)	$\frac{2.80 \pm 0.20}{(.110 \pm .008)}$	$\frac{5.30 \pm 0.20}{(.209 \pm .008)}$	$\frac{12.00 \pm 0.20}{(.472 \pm .008)}$	$\frac{5.50 \pm 0.05}{(.217 \pm .002)}$	$\frac{1.75 \pm 0.10}{(.069 \pm .004)}$	$\frac{4.00 \pm 0.10}{(.157 \pm .004)}$	$\frac{2.00 \pm 0.05}{(.079 \pm .002)}$	$\frac{4.00 \pm 0.10}{(.157 \pm .004)}$	$\frac{0.85 \pm 0.15}{(.033 \pm .006)}$
CR2512		$\frac{3.60 \pm 0.20}{(.142 \pm .008)}$	$\frac{6.90 \pm 0.20}{(.272 \pm .008)}$							$\frac{0.85 \pm 0.15}{(.033 \pm .006)}$

Specifications are subject to change without notice.

Users should verify actual device performance in their specific applications.

The products described herein and this document are subject to specific legal disclaimers as set forth on the last page of this document, and at [www.bourns.com/docs/legal/disclaimer.pdf](http://www.bourns.com/docs/legal/disclaimer.pdf).

# CR Series - Thick Film Chip Resistors

**BOURNS®**

## Packaging Dimensions (Conforms to EIA RS-481A)

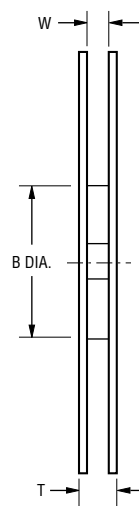
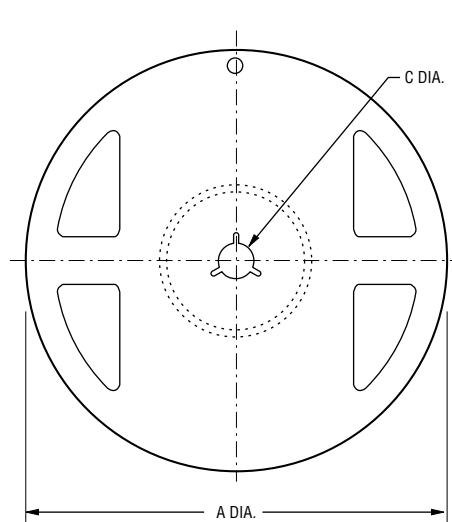

DIMENSIONS:  $\frac{\text{MM}}{(\text{INCHES})}$

Model	Packaging Quantity	A	B	C	W	T
CR01005	10K pcs./reel	$\frac{178 \pm 2.0}{(7.008 \pm .079)}$	$\frac{60 \pm 1.0}{(2.362 \pm .039)}$	$\frac{13.0 \pm 1.0}{(.512 \pm .039)}$	$\frac{9.0 \pm 1.0}{(.354 \pm .039)}$	$\frac{11.5 \pm 1.0}{(.453 \pm .039)}$
CR0201						
CR0402						
CR0603	5K pcs./reel	$\frac{178 \pm 2.0}{(7.008 \pm .079)}$	$\frac{60 \pm 1.0}{(2.362 \pm .039)}$	$\frac{13.0 \pm 1.0}{(.512 \pm .039)}$	$\frac{9.0 \pm 1.0}{(.354 \pm .039)}$	$\frac{11.5 \pm 1.0}{(.453 \pm .039)}$
CR0805						
CR1206						
CR2010	4K pcs./reel	$\frac{178 \pm 2.0}{(7.008 \pm .079)}$	$\frac{60 \pm 1.0}{(2.362 \pm .039)}$	$\frac{13.0 \pm 1.0}{(.512 \pm .039)}$	$\frac{9.0 \pm 1.0}{(.354 \pm .039)}$	$\frac{11.5 \pm 1.0}{(.453 \pm .039)}$
CR2512						

REV. 12/20

Specifications are subject to change without notice.

Users should verify actual device performance in their specific applications.

The products described herein and this document are subject to specific legal disclaimers as set forth on the last page of this document, and at [www.bourns.com/docs/legal/disclaimer.pdf](http://www.bourns.com/docs/legal/disclaimer.pdf).



This legal disclaimer applies to purchasers and users of Bourns® products manufactured by or on behalf of Bourns, Inc. and its affiliates (collectively, "Bourns").

Unless otherwise expressly indicated in writing, Bourns® products and data sheets relating thereto are subject to change without notice. Users should check for and obtain the latest relevant information and verify that such information is current and complete before placing orders for Bourns® products.

The characteristics and parameters of a Bourns® product set forth in its data sheet are based on laboratory conditions, and statements regarding the suitability of products for certain types of applications are based on Bourns' knowledge of typical requirements in generic applications. The characteristics and parameters of a Bourns® product in a user application may vary from the data sheet characteristics and parameters due to (i) the combination of the Bourns® product with other components in the user's application, or (ii) the environment of the user application itself. The characteristics and parameters of a Bourns® product also can and do vary in different applications and actual performance may vary over time. Users should always verify the actual performance of the Bourns® product in their specific devices and applications, and make their own independent judgments regarding the amount of additional test margin to design into their device or application to compensate for differences between laboratory and real world conditions.

Unless Bourns has explicitly designated an individual Bourns® product as meeting the requirements of a particular industry standard (e.g., ISO/TS 16949) or a particular qualification (e.g., UL listed or recognized), Bourns is not responsible for any failure of an individual Bourns® product to meet the requirements of such industry standard or particular qualification. Users of Bourns® products are responsible for ensuring compliance with safety-related requirements and standards applicable to their devices or applications.

Bourns® products are not recommended, authorized or intended for use in nuclear, lifesaving, life-critical or life-sustaining applications, nor in any other applications where failure or malfunction may result in personal injury, death, or severe property or environmental damage. Unless expressly and specifically approved in writing by two authorized Bourns representatives on a case-by-case basis, use of any Bourns® products in such unauthorized applications might not be safe and thus is at the user's sole risk. Life-critical applications include devices identified by the U.S. Food and Drug Administration as Class III devices and generally equivalent classifications outside of the United States.

Bourns expressly identifies those Bourns® standard products that are suitable for use in automotive applications on such products' data sheets in the section entitled "Applications." Unless expressly and specifically approved in writing by two authorized Bourns representatives on a case-by-case basis, use of any other Bourns® standard products in an automotive application might not be safe and thus is not recommended, authorized or intended and is at the user's sole risk. If Bourns expressly identifies a sub-category of automotive application in the data sheet for its standard products (such as infotainment or lighting), such identification means that Bourns has reviewed its standard product and has determined that if such Bourns® standard product is considered for potential use in automotive applications, it should only be used in such sub-category of automotive applications. Any reference to Bourns® standard product in the data sheet as compliant with the AEC-Q standard or "automotive grade" does not by itself mean that Bourns has approved such product for use in an automotive application.

Bourns® standard products are not tested to comply with United States Federal Aviation Administration standards generally or any other generally equivalent governmental organization standard applicable to products designed or manufactured for use in aircraft or space applications. Bourns expressly identifies Bourns® standard products that are suitable for use in aircraft or space applications on such products' data sheets in the section entitled "Applications." Unless expressly and specifically approved in writing by two authorized Bourns representatives on a case-by-case basis, use of any other Bourns® standard product in an aircraft or space application might not be safe and thus is not recommended, authorized or intended and is at the user's sole risk.

The use and level of testing applicable to Bourns® custom products shall be negotiated on a case-by-case basis by Bourns and the user for which such Bourns® custom products are specially designed. Absent a written agreement between Bourns and the user regarding the use and level of such testing, the above provisions applicable to Bourns® standard products shall also apply to such Bourns® custom products.

Users shall not sell, transfer, export or re-export any Bourns® products or technology for use in activities which involve the design, development, production, use or stockpiling of nuclear, chemical or biological weapons or missiles, nor shall they use Bourns® products or technology in any facility which engages in activities relating to such devices. The foregoing restrictions apply to all uses and applications that violate national or international prohibitions, including embargos or international regulations. Further, Bourns® products and Bourns technology and technical data may not under any circumstance be exported or re-exported to countries subject to international sanctions or embargoes. Bourns® products may not, without prior authorization from Bourns and/or the U.S. Government, be resold, transferred, or re-exported to any party not eligible to receive U.S. commodities, software, and technical data.

To the maximum extent permitted by applicable law, Bourns disclaims (i) any and all liability for special, punitive, consequential, incidental or indirect damages or lost revenues or lost profits, and (ii) any and all implied warranties, including implied warranties of fitness for particular purpose, non-infringement and merchantability.

*For your convenience, copies of this Legal Disclaimer Notice with German, Spanish, Japanese, Traditional Chinese and Simplified Chinese bilingual versions are available at:*

Web Page: <http://www.bourns.com/legal/disclaimers-terms-and-policies>

PDF: <http://www.bourns.com/docs/Legal/disclaimer.pdf>