

# TPA711

## 700-mW MONO LOW-VOLTAGE AUDIO POWER AMPLIFIER

SLOS230D – NOVEMBER 1998 – REVISED OCTOBER 2002

- Fully Specified for 3.3-V and 5-V Operation
- Wide Power Supply Compatibility  
2.5 V – 5.5 V
- Output Power
  - 700 mW at  $V_{DD} = 5\text{ V}$ , BTL,  $R_L = 8\ \Omega$
  - 85 mW at  $V_{DD} = 5\text{ V}$ , SE,  $R_L = 32\ \Omega$
  - 250 mW at  $V_{DD} = 3.3\text{ V}$ , BTL,  $R_L = 8\ \Omega$
  - 37 mW at  $V_{DD} = 3.3\text{ V}$ , SE,  $R_L = 32\ \Omega$
- Shutdown Control
  - $I_{DD} = 7\ \mu\text{A}$  at 3.3 V
  - $I_{DD} = 50\ \mu\text{A}$  at 5 V
- BTL to SE Mode Control
- Integrated Depop Circuitry
- Thermal and Short-Circuit Protection
- Surface-Mount Packaging
  - SOIC
  - PowerPAD™ MSOP

### description

The TPA711 is a bridge-tied load (BTL) or single-ended (SE) audio power amplifier developed especially for low-voltage applications where internal speakers and external earphone operation are required. Operating with a 3.3-V supply, the TPA711 can deliver 250-mW of continuous power into a BTL 8- $\Omega$  load at less than 0.6% THD+N throughout voice band frequencies. Although this device is characterized out to 20 kHz, its operation is optimized for narrower band applications such as wireless communications. The BTL configuration eliminates the need for external coupling capacitors on the output in most applications, which is particularly important for small battery-powered equipment. A unique feature of the TPA711 is that it allows the amplifier to switch from BTL to SE *on the fly* when an earphone drive is required. This eliminates complicated mechanical switching or auxiliary devices just to drive the external load. This device features a shutdown mode for power-sensitive applications with special depop circuitry to eliminate speaker noise when exiting shutdown mode. The TPA711 is available in an 8-pin SOIC and the surface-mount PowerPAD MSOP package, which reduces board space by 50% and height by 40%.

D OR DGN PACKAGE  
(TOP VIEW)

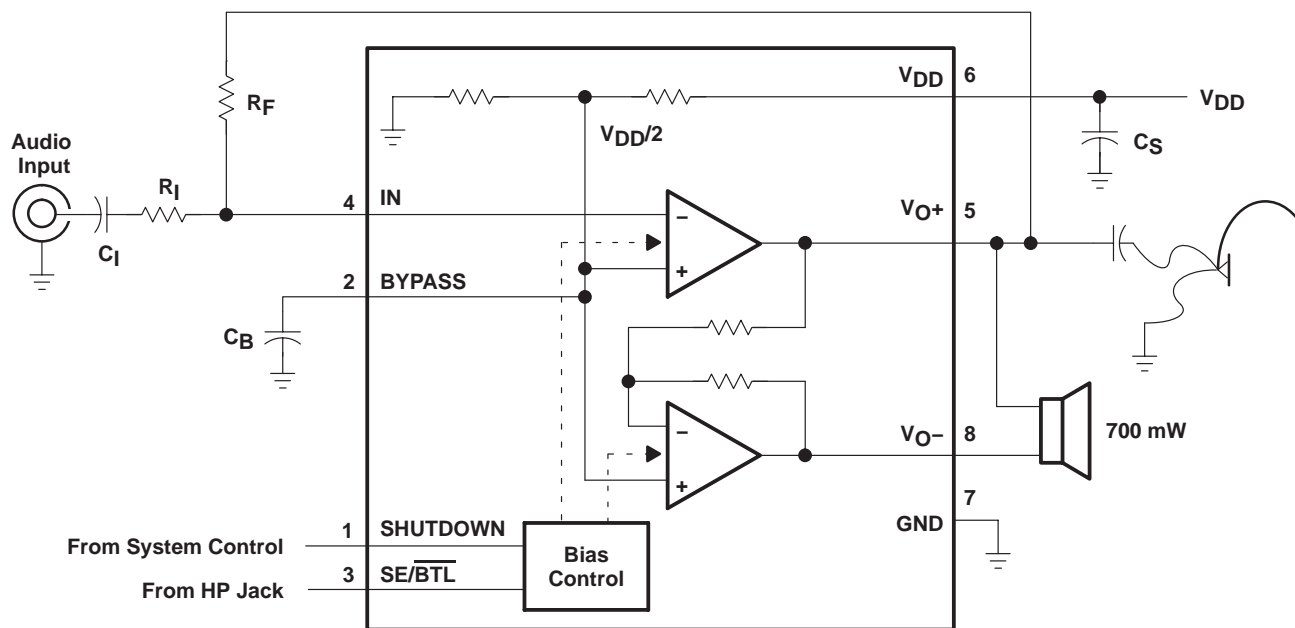
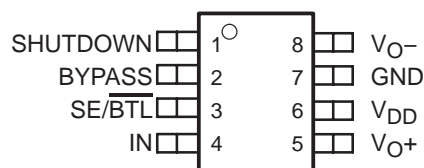

Please be aware that an important notice concerning availability, standard warranty, and use in critical applications of Texas Instruments semiconductor products and disclaimers thereto appears at the end of this data sheet.

PowerPAD is a trademark of Texas Instruments.

PRODUCTION DATA information is current as of publication date. Products conform to specifications per the terms of Texas Instruments standard warranty. Production processing does not necessarily include testing of all parameters.



POST OFFICE BOX 655303 • DALLAS, TEXAS 75265

Copyright © 2002, Texas Instruments Incorporated

# TPA711

## 700-mW MONO LOW-VOLTAGE AUDIO POWER AMPLIFIER

SLOS230D – NOVEMBER 1998 – REVISED OCTOBER 2002

### AVAILABLE OPTIONS

T <sub>A</sub>	PACKAGED DEVICES		MSOP SYMBOLIZATION
	SMALL OUTLINE† (D)	MSOP‡ (DGN)	
-40°C to 85°C	TPA711D	TPA711DGN	ABB

† In the SOIC package, the maximum RMS output power is thermally limited to 350 mW; 700 mW peaks can be driven, as long as the RMS value is less than 350 mW.

‡ The D and DGN packages are available taped and reeled. To order a taped and reeled part, add the suffix R to the part number (e.g., TPA311DR).

### Terminal Functions

TERMINAL NAME	NO.	I/O	DESCRIPTION
BYPASS	2	I	BYPASS is the tap to the voltage divider for internal mid-supply bias. This terminal should be connected to a 0.1-μF to 2.2-μF capacitor when used as an audio amplifier.
GND	7		GND is the ground connection.
IN	4	I	IN is the audio input terminal.
SE/BTL	3	I	When SE/BTL is held low, the TPA711 is in BTL mode. When SE/BTL is held high, the TPA711 is in SE mode.
SHUTDOWN	1	I	SHUTDOWN places the entire device in shutdown mode when held high (I <sub>DD</sub> = 7 μA).
V <sub>DD</sub>	6		V <sub>DD</sub> is the supply voltage terminal.
V <sub>O+</sub>	5	O	V <sub>O+</sub> is the positive output for BTL and SE modes.
V <sub>O-</sub>	8	O	V <sub>O-</sub> is the negative output in BTL mode and a high-impedance output in SE mode.

### absolute maximum ratings over operating free-air temperature range (unless otherwise noted)§

Supply voltage, V <sub>DD</sub>	6 V
Input voltage, V <sub>I</sub>	-0.3 V to V <sub>DD</sub> + 0.3 V
Continuous total power dissipation	Internally limited (see Dissipation Rating Table)
Operating free-air temperature range, T <sub>A</sub> (see Table 3)	-40°C to 85°C
Operating junction temperature range, T <sub>J</sub>	-40°C to 150°C
Storage temperature range, T <sub>stg</sub>	-65°C to 150°C
Lead temperature 1,6 mm (1/16 inch) from case for 10 seconds	260°C

§ Stresses beyond those listed under “absolute maximum ratings” may cause permanent damage to the device. These are stress ratings only, and functional operation of the device at these or any other conditions beyond those indicated under “recommended operating conditions” is not implied. Exposure to absolute-maximum-rated conditions for extended periods may affect device reliability.

### DISSIPATION RATING TABLE

PACKAGE	T <sub>A</sub> ≤ 25°C	DERATING FACTOR	T <sub>A</sub> = 70°C	T <sub>A</sub> = 85°C
D	725 mW	5.8 mW/°C	464 mW	377 mW
DGN	2.14 W <sup>¶</sup>	17.1 mW/°C	1.37 W	1.11 W

¶ Please see the Texas Instruments document, *PowerPAD Thermally Enhanced Package Application Report* (SLMA002), for more information on the PowerPAD package. The thermal data was measured on a PCB layout based on the information in the section entitled *Texas Instruments Recommended Board for PowerPAD* on page 33 of that document.



# TPA711

## 700-mW MONO LOW-VOLTAGE AUDIO POWER AMPLIFIER

SLOS230D – NOVEMBER 1998 – REVISED OCTOBER 2002

### recommended operating conditions

		MIN	MAX	UNIT
Supply voltage, $V_{DD}$		2.5	5.5	V
High-level voltage, $V_{IH}$	SHUTDOWN	$0.9V_{DD}$		V
	$\overline{SE/BTL}$	$0.9V_{DD}$		
Low-level voltage, $V_{IL}$	SHUTDOWN	$0.1V_{DD}$		V
	$\overline{SE/BTL}$	$0.1V_{DD}$		
Operating free-air temperature, $T_A$ (see Table 3)		-40	85	°C

### electrical characteristics at specified free-air temperature, $V_{DD} = 3.3$ V, $T_A = 25^\circ\text{C}$ (unless otherwise noted)

PARAMETER	TEST CONDITIONS	MIN	TYP	MAX	UNIT
$V_{OO}$ Output offset voltage (measured differentially)	SHUTDOWN = 0 V, $\overline{SE/BTL} = 0$ V, $R_L = 8 \Omega$ , $R_F = 10$ k $\Omega$			20	mV
PSRR Power supply rejection ratio	$V_{DD} = 3.2$ V to 3.4 V	BTL mode	85		dB
		SE mode	83		
$I_{DD}$ Supply current (see Figure 6)	BTL mode, SHUTDOWN = 0 V, $\overline{SE/BTL} = 0.33$ V, $R_F = 10$ k $\Omega$		1.25	2.5	mA
	SE mode, SHUTDOWN = 0 V, $\overline{SE/BTL} = 2.97$ V, $R_F = 10$ k $\Omega$		0.65	1.25	
$I_{DD(SD)}$ Supply current, shutdown mode (see Figure 7)	$\overline{SE/BTL} = 2.97$ V, SHUTDOWN = $V_{DD}$ , $R_F = 10$ k $\Omega$		7	50	$\mu\text{A}$
$ I_{IH} $	SHUTDOWN, $V_{DD} = 3.3$ V, $V_I = V_{DD}$			1	$\mu\text{A}$
	$\overline{SE/BTL}$ , $V_{DD} = 3.3$ V, $V_I = V_{DD}$			1	
$ I_{IL} $	SHUTDOWN, $V_{DD} = 3.3$ V, $V_I = 0$ V			1	$\mu\text{A}$
	$\overline{SE/BTL}$ , $V_{DD} = 3.3$ V, $V_I = 0$ V			1	

### operating characteristics, $V_{DD} = 3.3$ V, $T_A = 25^\circ\text{C}$ , $R_L = 8 \Omega$

PARAMETER	TEST CONDITIONS	MIN	TYP	MAX	UNIT
$P_O$ Output power, see Note 1	THD = 0.2%, BTL mode, See Figure 14		250		mW
	THD = 0.1%, SE mode, $R_L = 32 \Omega$ , See Figure 22		37		
THD + N Total harmonic distortion plus noise	$P_O = 250$ mW, $f = 200$ Hz to 4 kHz, See Figure 12		0.55%		
$B_{OM}$ Maximum output power bandwidth	Gain = 2, THD = 2%, See Figure 12		20		kHz
$B_1$ Unity-gain bandwidth	Open Loop, See Figure 36		1.4		MHz
Supply ripple rejection ratio	$f = 1$ kHz, $C_B = 1 \mu\text{F}$ , BTL mode, See Figure 5		79		dB
	$f = 1$ kHz, $C_B = 1 \mu\text{F}$ , SE mode, See Figure 3		70		
$V_n$ Noise output voltage	Gain = 1, $C_B = 0.1 \mu\text{F}$ , See Figure 42		17		$\mu\text{V(rms)}$

NOTE 1: Output power is measured at the output terminals of the device at  $f = 1$  kHz.



# TPA711

## 700-mW MONO LOW-VOLTAGE AUDIO POWER AMPLIFIER

SLOS230D – NOVEMBER 1998 – REVISED OCTOBER 2002

electrical characteristics at specified free-air temperature,  $V_{DD} = 5\text{ V}$ ,  $T_A = 25^\circ\text{C}$  (unless otherwise noted)

PARAMETER		TEST CONDITIONS		MIN	TYP	MAX	UNIT
$V_{OO}$	Output offset voltage (measured differentially)	SHUTDOWN = 0 V, SE/BTL = 0 V, $R_L = 8\ \Omega$ , $R_F = 10\ \text{k}\Omega$				20	mV
PSRR	Power supply rejection ratio	$V_{DD} = 4.9\text{ V to }5.1\text{ V}$	BTL mode		78		dB
			SE mode		76		
$I_{DD}$	Supply current (see Figure 6)	BTL mode, SHUTDOWN = 0 V, SE/BTL = 0.5 V, $R_F = 10\ \text{k}\Omega$			1.25	2.5	mA
		SE mode, SHUTDOWN = 0 V, SE/BTL = 4.5 V, $R_F = 10\ \text{k}\Omega$			0.65	1.25	
$I_{DD(SD)}$	Supply current, shutdown mode (see Figure 7)	SE/BTL = 0 V, SHUTDOWN = $V_{DD}$ , $R_F = 10\ \text{k}\Omega$			50	100	$\mu\text{A}$
$ I_{IH} $		SHUTDOWN, $V_{DD} = 5.5\text{ V}$ , $V_I = V_{DD}$				1	$\mu\text{A}$
		SE/BTL, $V_{DD} = 5.5\text{ V}$ , $V_I = V_{DD}$				1	
$ I_{IL} $		SHUTDOWN, $V_{DD} = 5.5\text{ V}$ , $V_I = 0\text{ V}$				1	$\mu\text{A}$
		SE/BTL, $V_{DD} = 5.5\text{ V}$ , $V_I = 0\text{ V}$				1	

operating characteristics,  $V_{DD} = 5\text{ V}$ ,  $T_A = 25^\circ\text{C}$ ,  $R_L = 8\ \Omega$

PARAMETER		TEST CONDITIONS		MIN	TYP	MAX	UNIT
$P_O$	Output power, see Note 1	THD = 0.3%,	BTL mode, See Figure 18		700 <sup>†</sup>		mW
		THD = 0.1%, See Figure 26	SE mode, $R_L = 32\ \Omega$ ,		85		
THD + N	Total harmonic distortion plus noise	$P_O = 700\text{ mW}$ , $f = 200\text{ Hz to }4\text{ kHz}$ , See Figure 16			0.5%		
$B_{OM}$	Maximum output power bandwidth	Gain = 2,	THD = 2%, See Figure 16		20		kHz
$B_1$	Unity-gain bandwidth	Open Loop,	See Figure 37		1.4		MHz
	Supply ripple rejection ratio	$f = 1\text{ kHz}$ , See Figure 5	$C_B = 1\ \mu\text{F}$ , BTL mode,		80		dB
		$f = 1\text{ kHz}$ , See Figure 4	$C_B = 1\ \mu\text{F}$ , SE mode,		73		
$V_n$	Noise output voltage	Gain = 1,	$C_B = 0.1\ \mu\text{F}$ , See Figure 43		17		$\mu\text{V(rms)}$

<sup>†</sup> The DGN package, properly mounted, can conduct 700 mW RMS power continuously. The D package, can only conduct 350 mW RMS power continuously, with peaks to 700 mW.

NOTE 1: Output power is measured at the output terminals of the device at  $f = 1\text{ kHz}$ .



**PARAMETER MEASUREMENT INFORMATION**

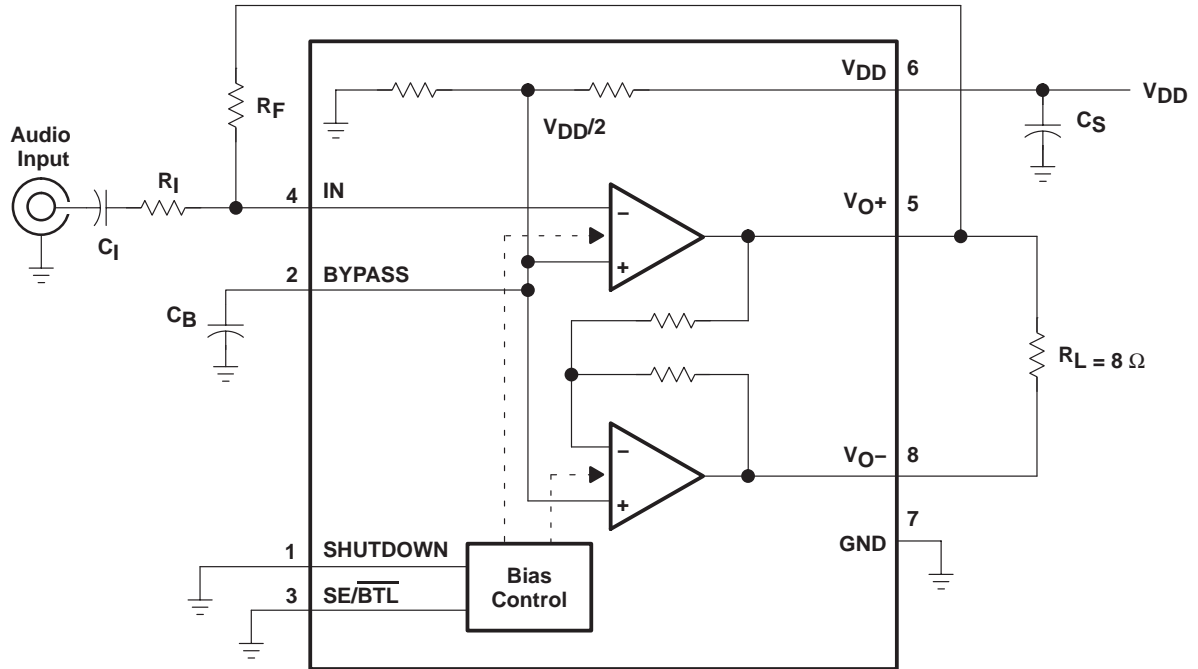

Figure 1. BTL Mode Test Circuit

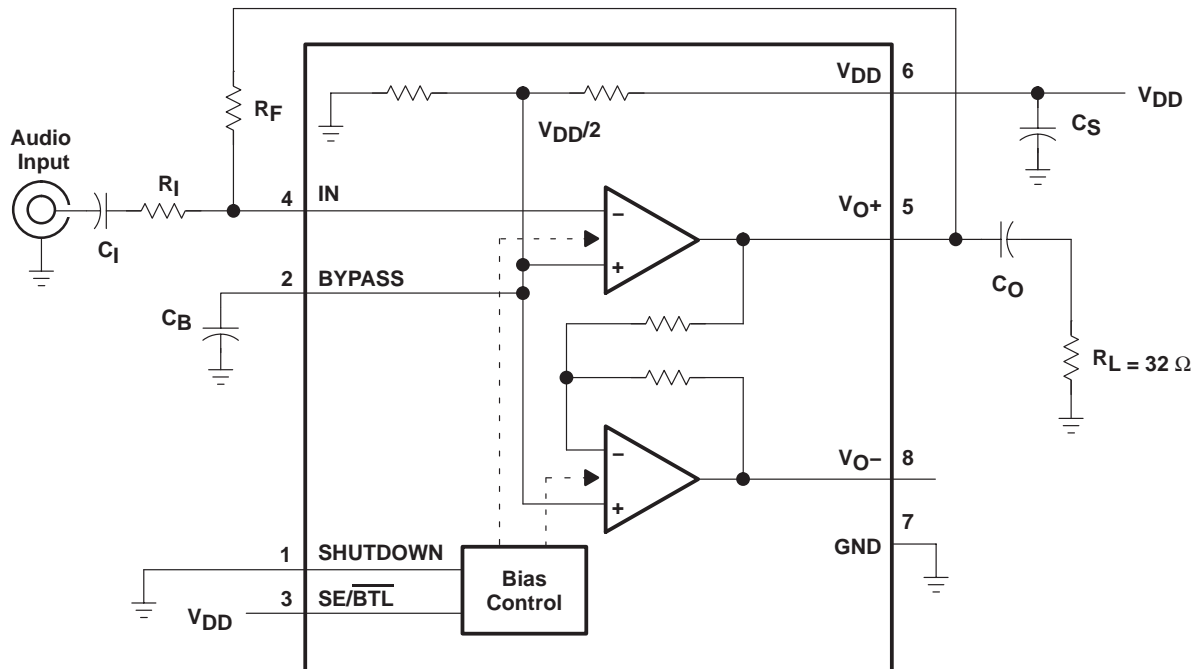

Figure 2. SE Mode Test Circuit

# TPA711 700-mW MONO LOW-VOLTAGE AUDIO POWER AMPLIFIER

SLOS230D – NOVEMBER 1998 – REVISED OCTOBER 2002

## TYPICAL CHARACTERISTICS

Table of Graphs

		FIGURE	
	Supply ripple rejection ratio	vs Frequency	3, 4, 5
$I_{DD}$	Supply current	vs Supply voltage	6, 7
$P_O$	Output power	vs Supply voltage	8, 9
		vs Load resistance	10, 11
THD+N	Total harmonic distortion plus noise	vs Frequency	12, 13, 16, 17, 20, 21, 24, 25, 28, 29, 32, 33
		vs Output power	14, 15, 18, 19, 22, 23, 26, 27, 30, 31, 34, 35
	Open loop gain and phase	vs Frequency	36, 37
	Closed loop gain and phase	vs Frequency	38, 39, 40, 41
$V_n$	Output noise voltage	vs Frequency	42, 43
$P_D$	Power dissipation	vs Output power	44, 45, 46, 47

SUPPLY RIPPLE REJECTION RATIO  
vs  
FREQUENCY

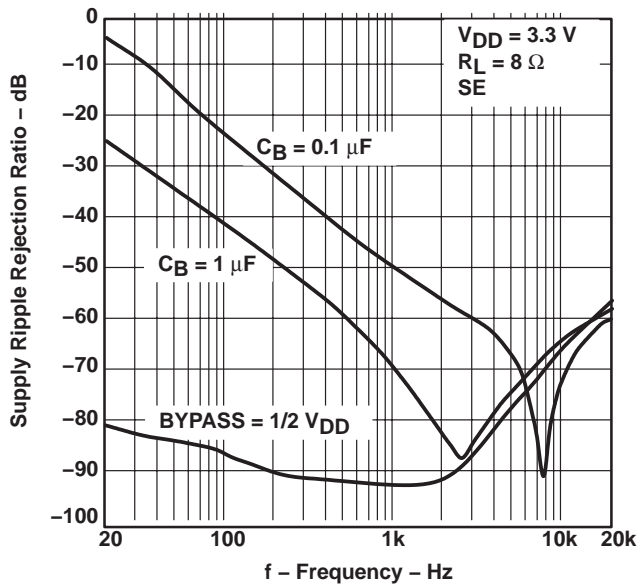

Figure 3

SUPPLY RIPPLE REJECTION RATIO  
vs  
FREQUENCY

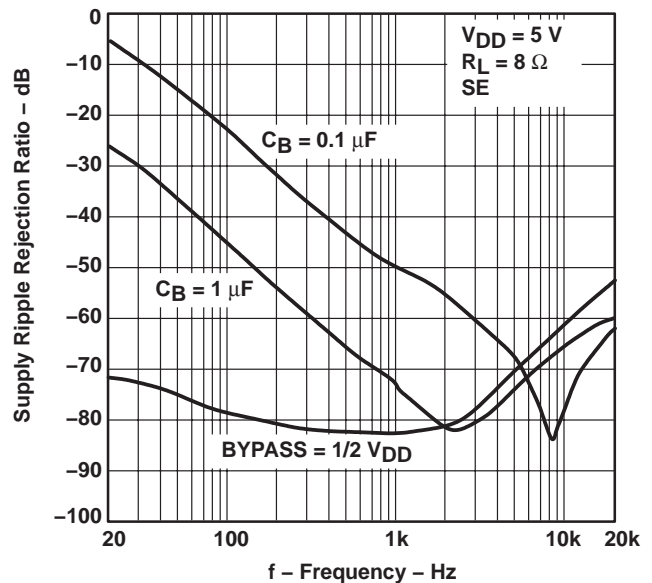

Figure 4

**TYPICAL CHARACTERISTICS**

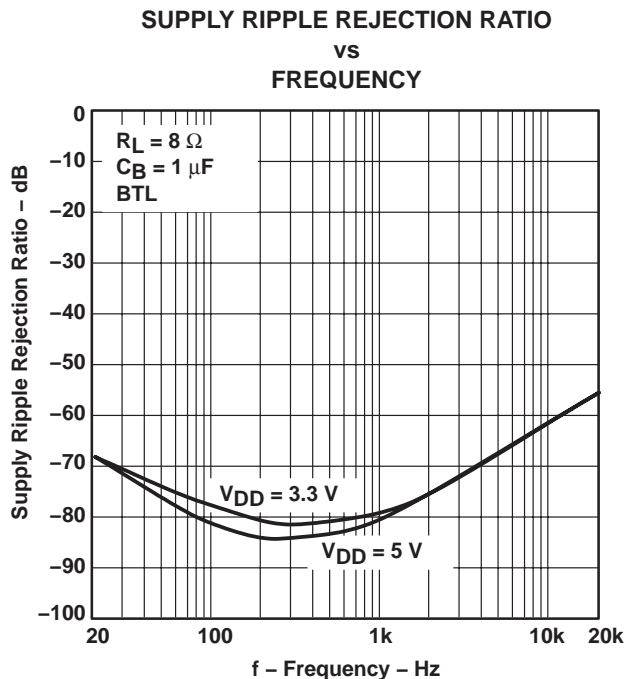

Figure 5

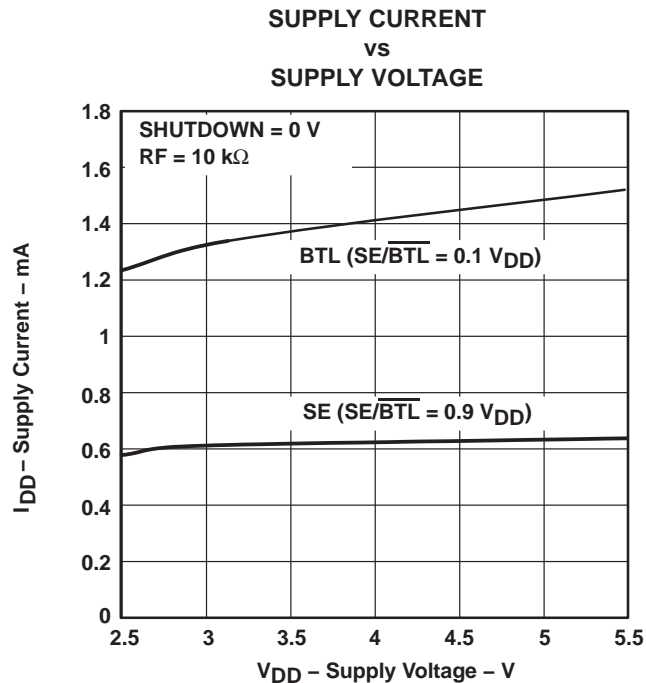

Figure 6

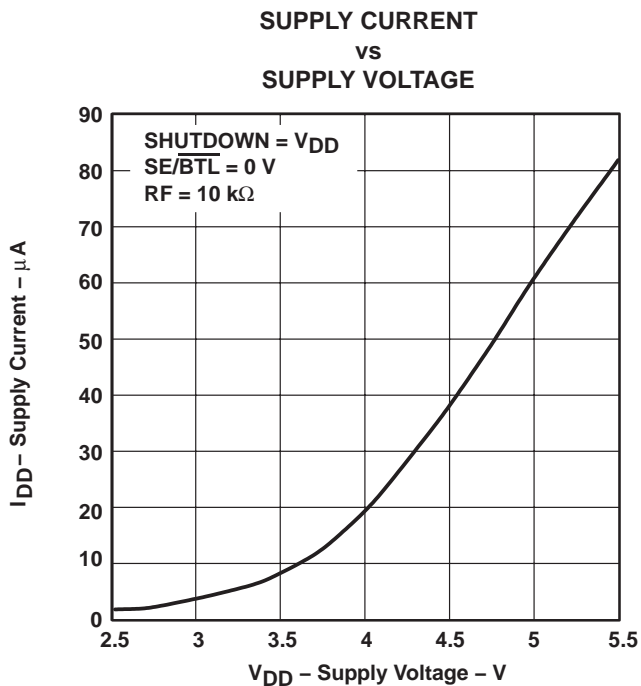

Figure 7

# TPA711 700-mW MONO LOW-VOLTAGE AUDIO POWER AMPLIFIER

SLOS230D – NOVEMBER 1998 – REVISED OCTOBER 2002

## TYPICAL CHARACTERISTICS

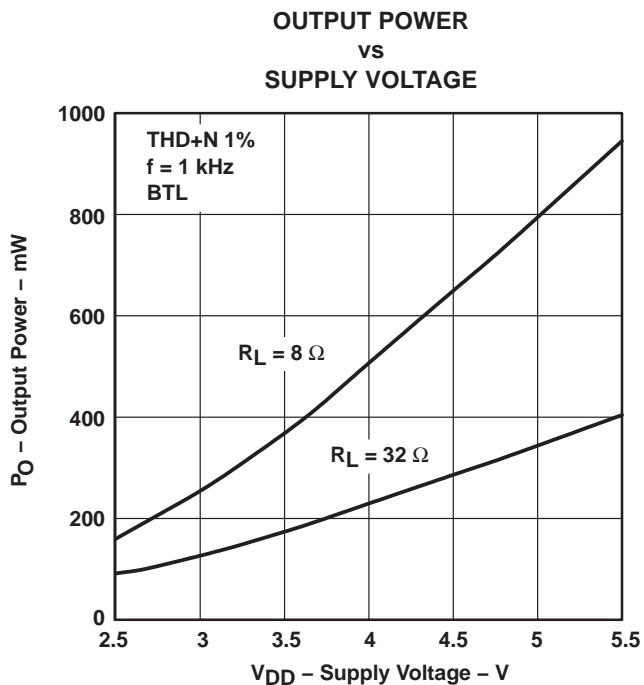

Figure 8

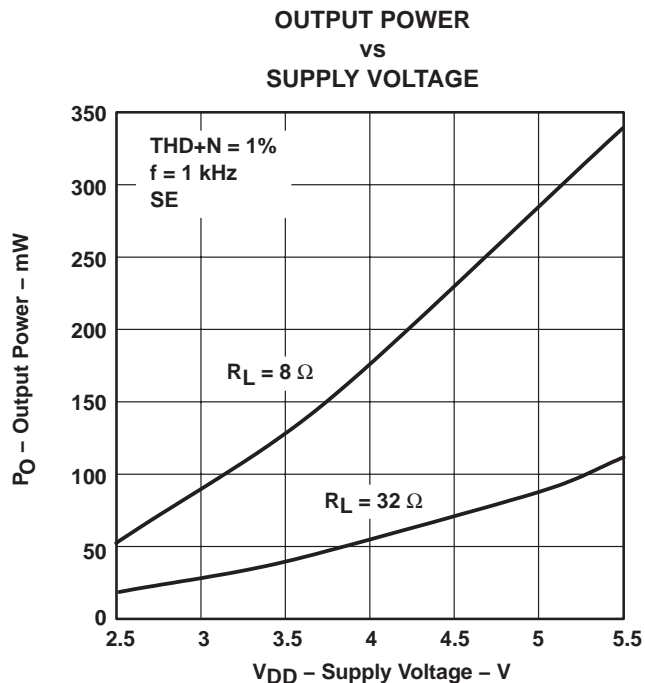

Figure 9

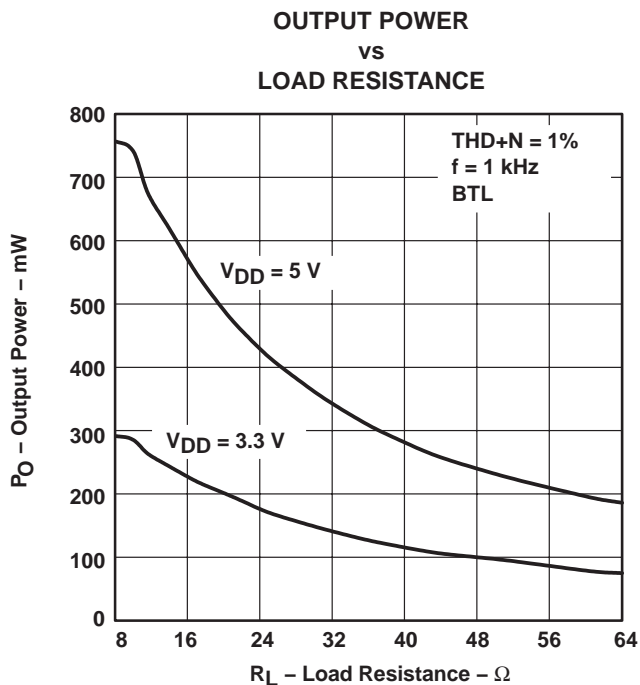

Figure 10

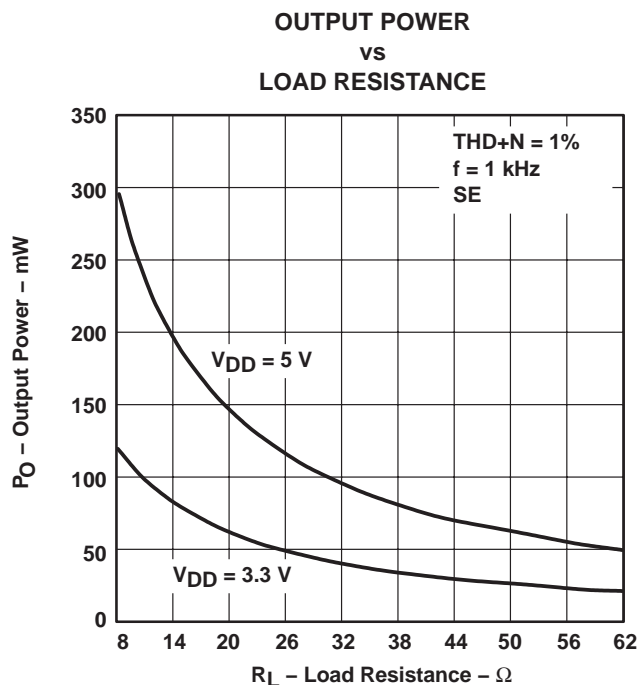

Figure 11



**TYPICAL CHARACTERISTICS**

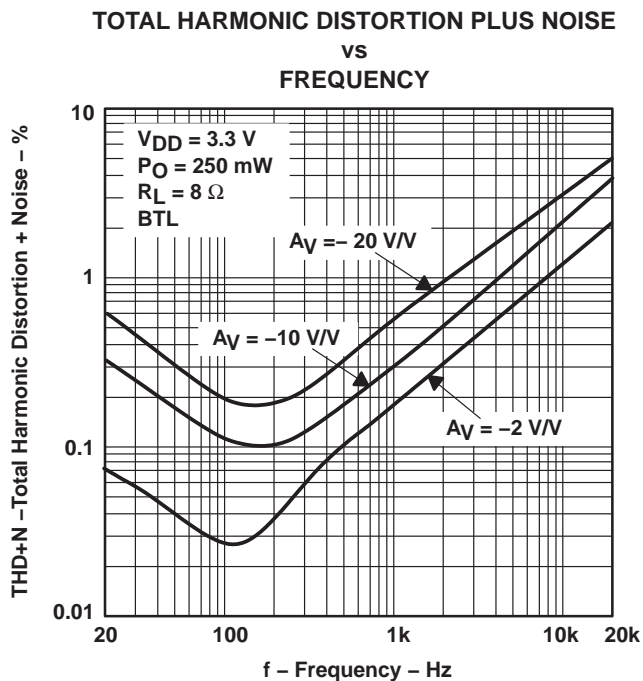

Figure 12

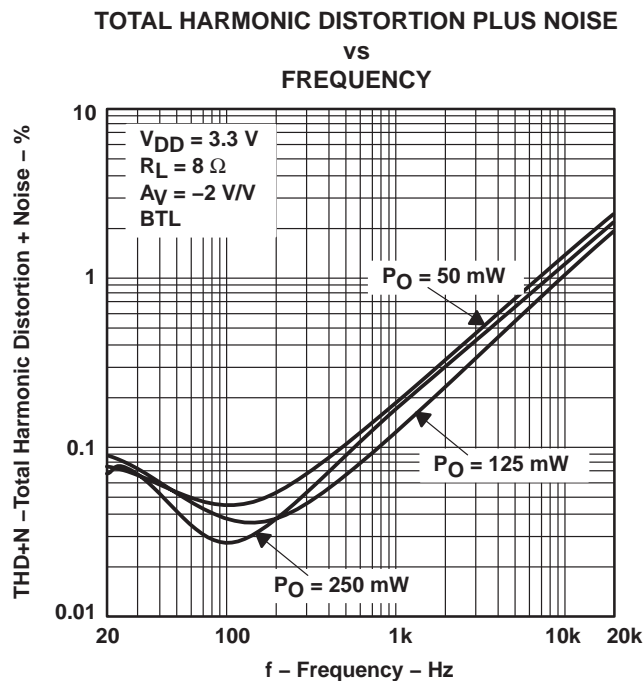

Figure 13

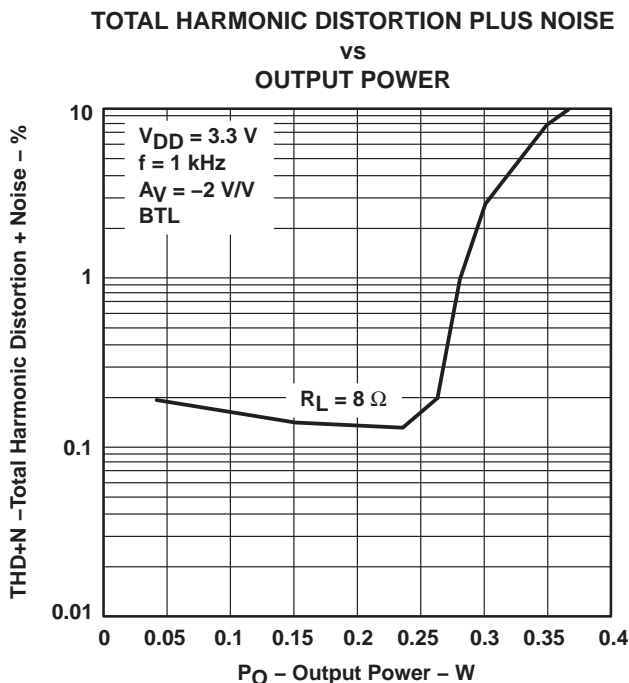

Figure 14

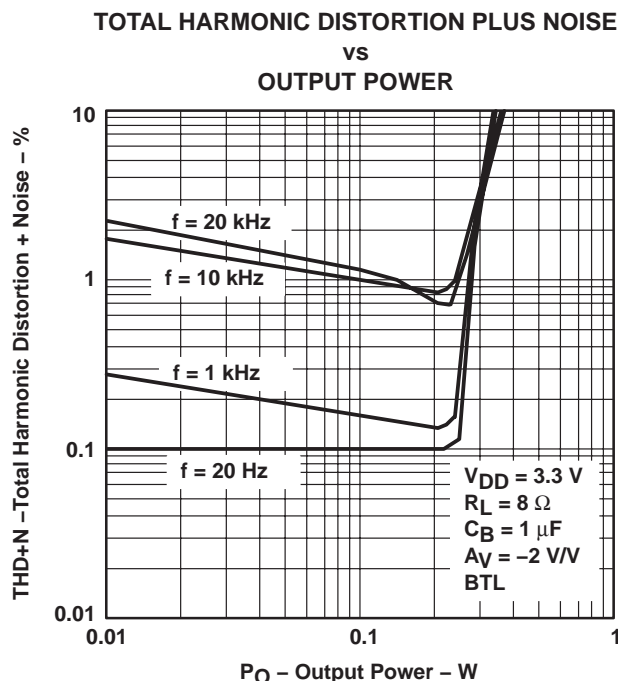

Figure 15

# TPA711

## 700-mW MONO LOW-VOLTAGE AUDIO POWER AMPLIFIER

SLOS230D – NOVEMBER 1998 – REVISED OCTOBER 2002

### TYPICAL CHARACTERISTICS

TOTAL HARMONIC DISTORTION PLUS NOISE  
vs  
FREQUENCY

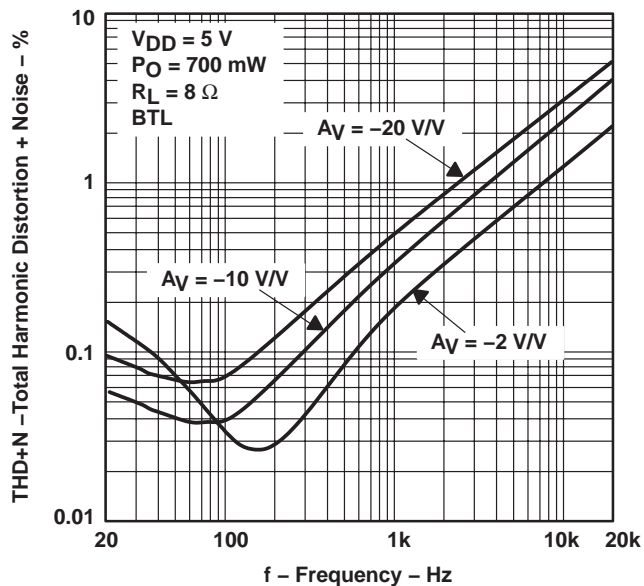

Figure 16

TOTAL HARMONIC DISTORTION PLUS NOISE  
vs  
FREQUENCY

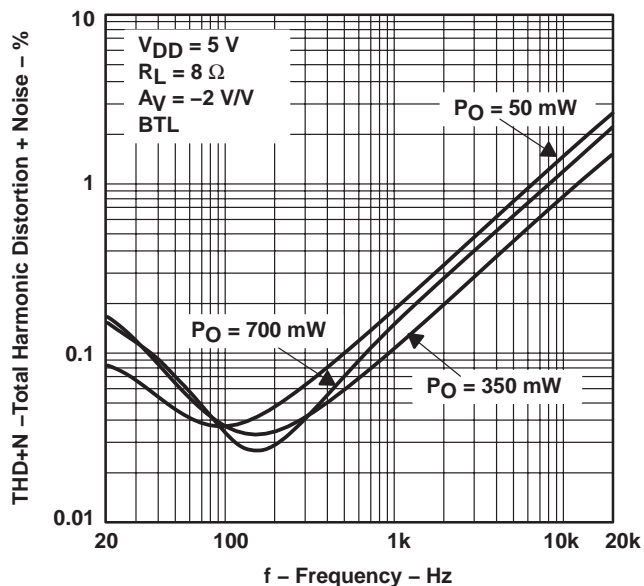

Figure 17

TOTAL HARMONIC DISTORTION PLUS NOISE  
vs  
OUTPUT POWER

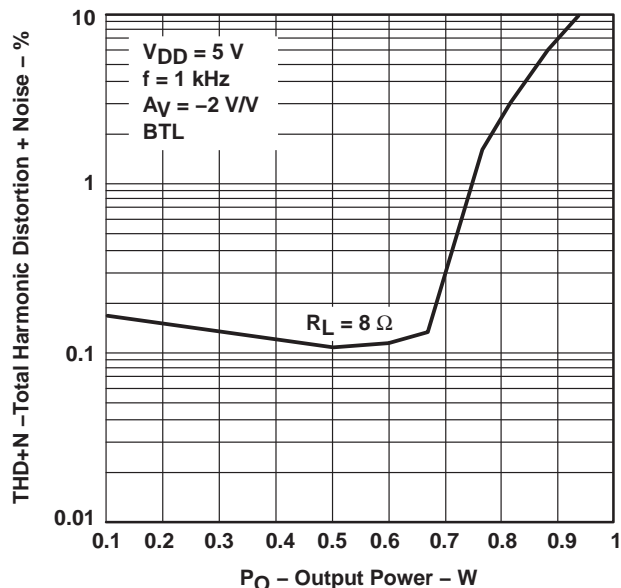

Figure 18

TOTAL HARMONIC DISTORTION PLUS NOISE  
vs  
OUTPUT POWER

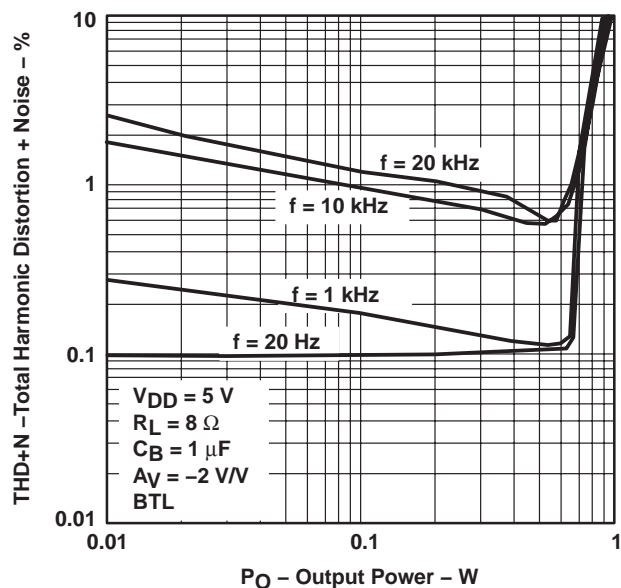

Figure 19



### TYPICAL CHARACTERISTICS

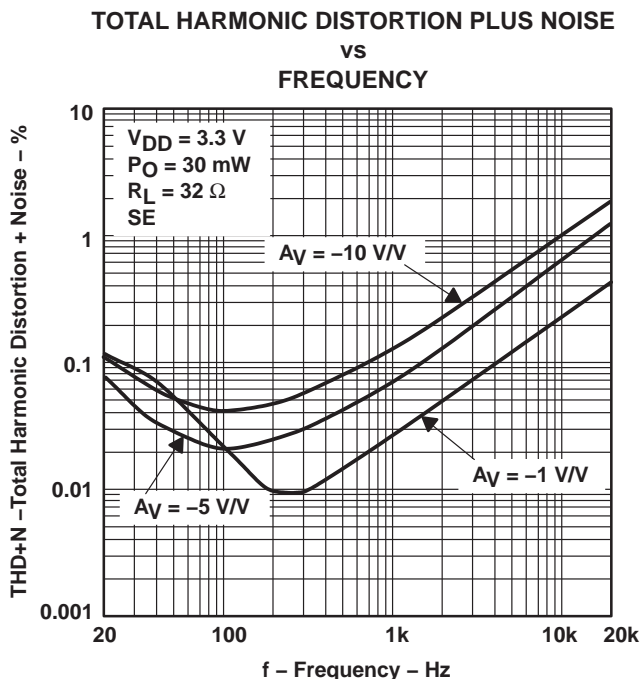

Figure 20

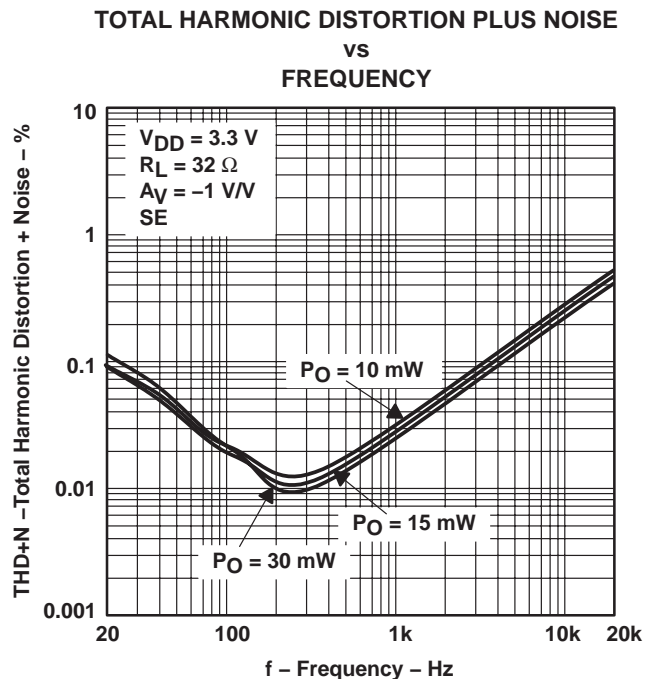

Figure 21

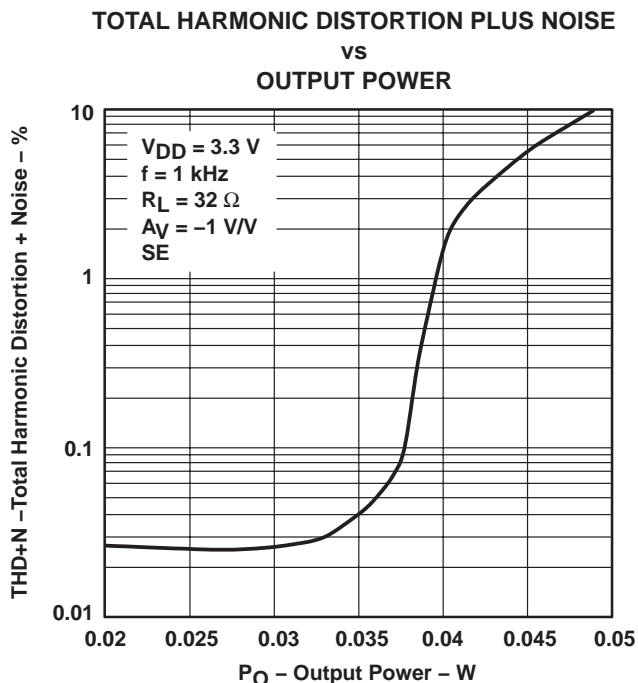

Figure 22

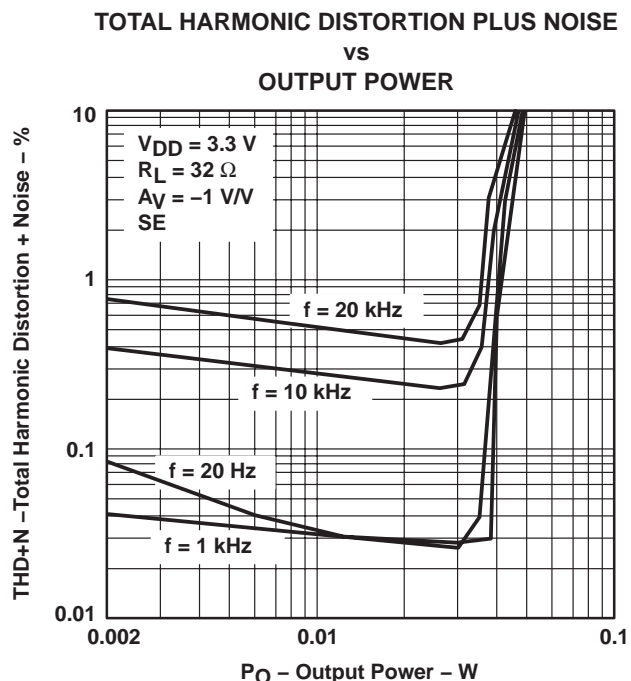

Figure 23

# TPA711 700-mW MONO LOW-VOLTAGE AUDIO POWER AMPLIFIER

SLOS230D – NOVEMBER 1998 – REVISED OCTOBER 2002

## TYPICAL CHARACTERISTICS

TOTAL HARMONIC DISTORTION PLUS NOISE  
vs  
FREQUENCY

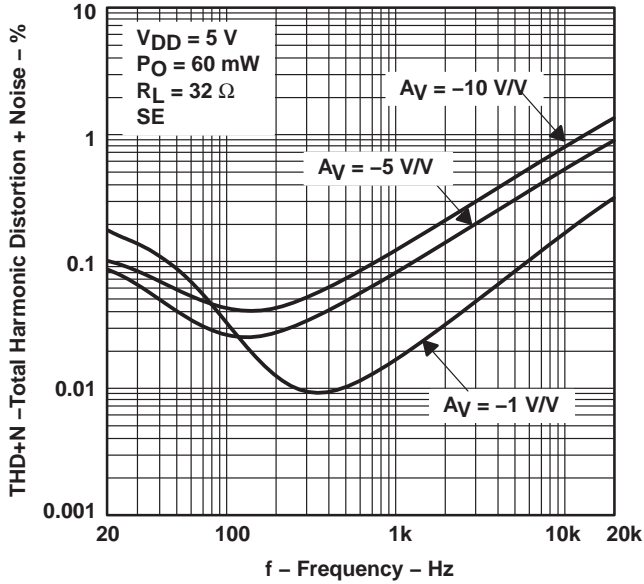

Figure 24

TOTAL HARMONIC DISTORTION PLUS NOISE  
vs  
FREQUENCY

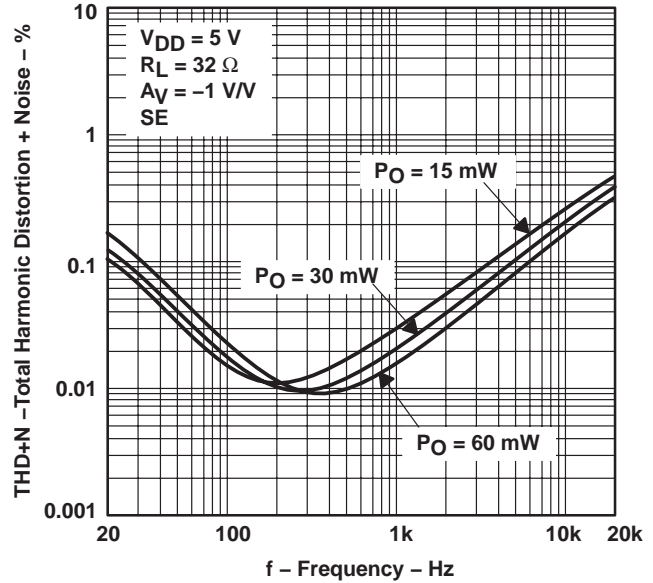

Figure 25

TOTAL HARMONIC DISTORTION PLUS NOISE  
vs  
OUTPUT POWER

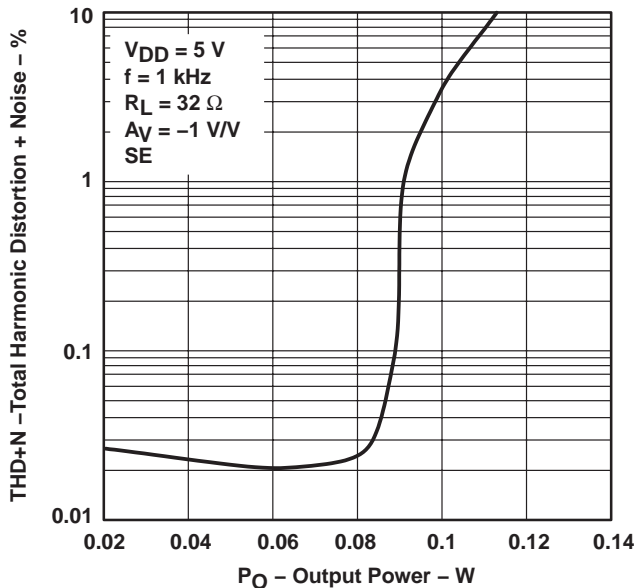

Figure 26

TOTAL HARMONIC DISTORTION PLUS NOISE  
vs  
OUTPUT POWER

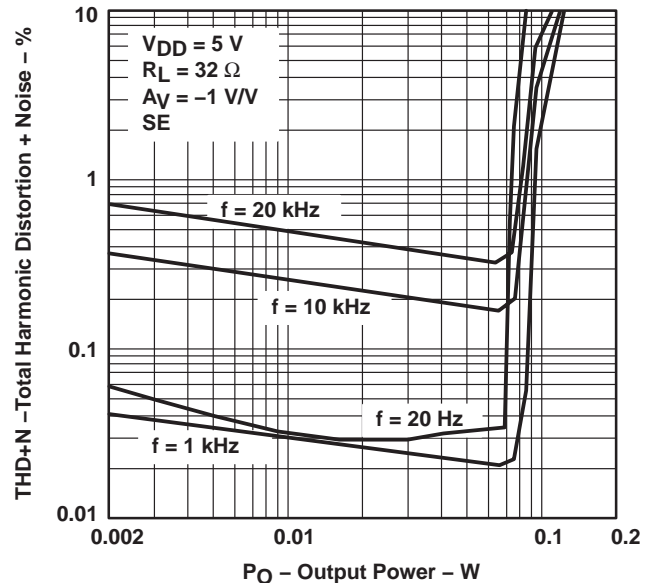

Figure 27

# TPA711

## 700-mW MONO LOW-VOLTAGE AUDIO POWER AMPLIFIER

SLOS230D – NOVEMBER 1998 – REVISED OCTOBER 2002

### TYPICAL CHARACTERISTICS

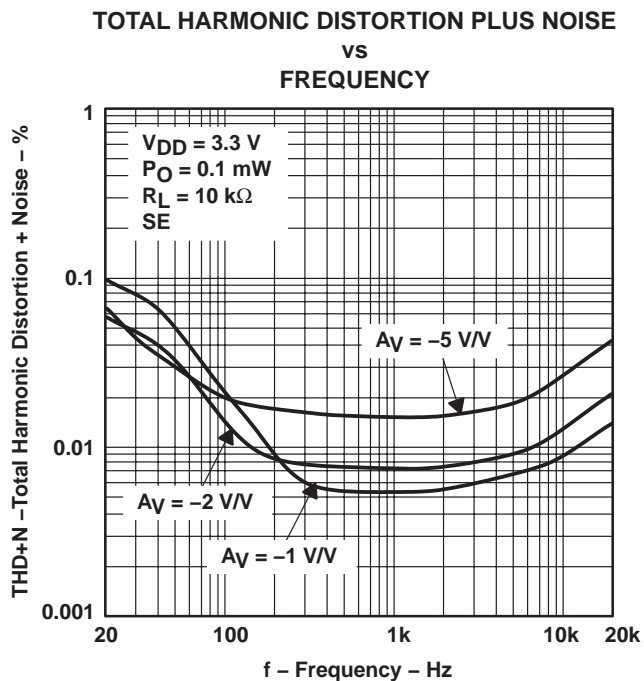

Figure 28

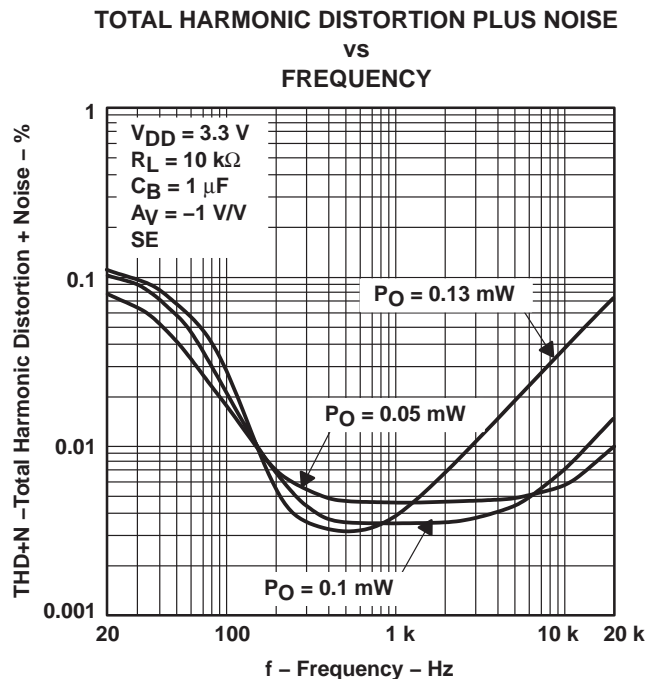

Figure 29

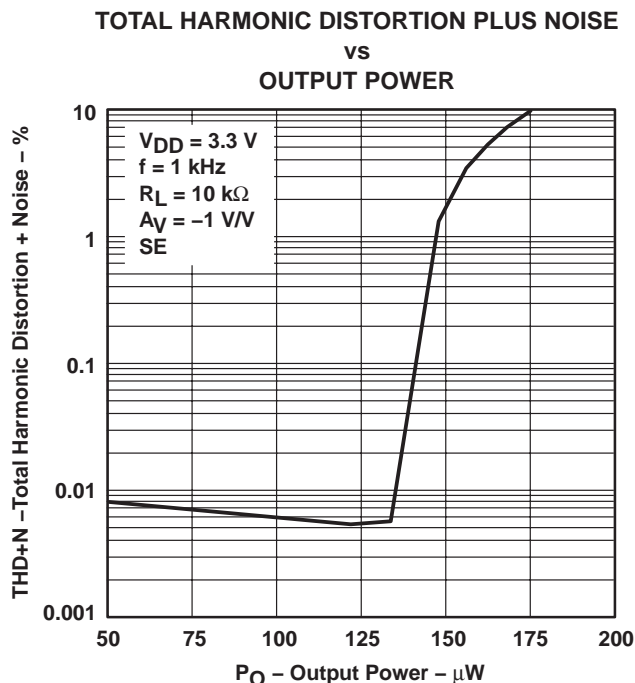

Figure 30

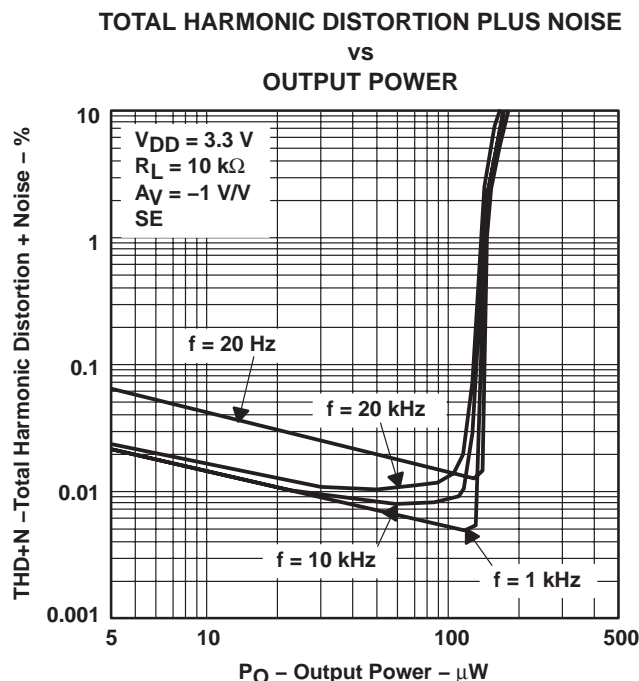

Figure 31

# TPA711

## 700-mW MONO LOW-VOLTAGE AUDIO POWER AMPLIFIER

SLOS230D – NOVEMBER 1998 – REVISED OCTOBER 2002

### TYPICAL CHARACTERISTICS

**TOTAL HARMONIC DISTORTION PLUS NOISE  
vs  
FREQUENCY**

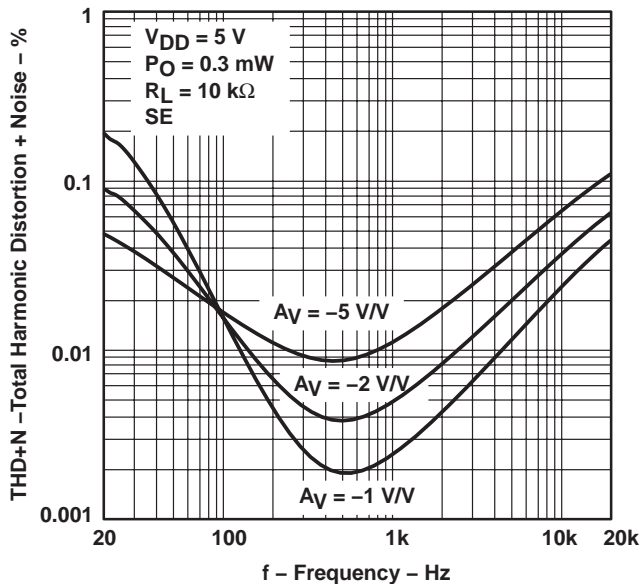

Figure 32

**TOTAL HARMONIC DISTORTION PLUS NOISE  
vs  
FREQUENCY**

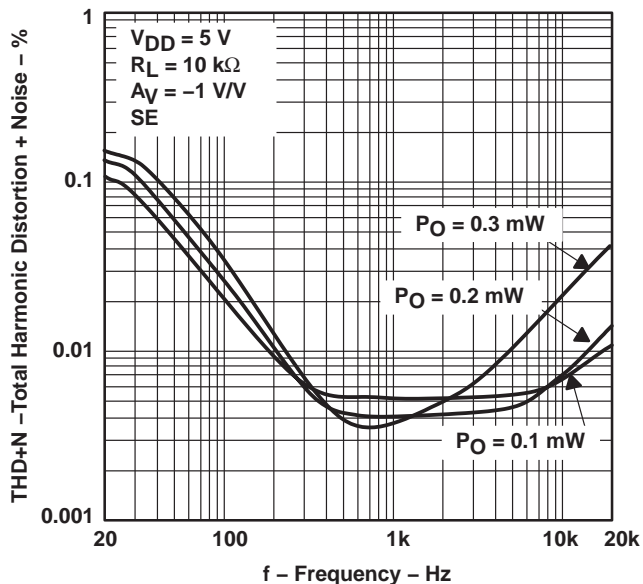

Figure 33

**TOTAL HARMONIC DISTORTION PLUS NOISE  
vs  
OUTPUT POWER**

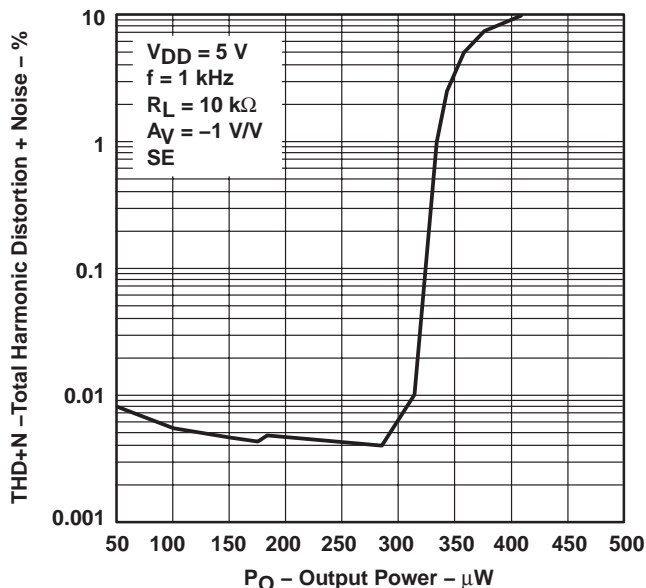

Figure 34

**TOTAL HARMONIC DISTORTION PLUS NOISE  
vs  
OUTPUT POWER**

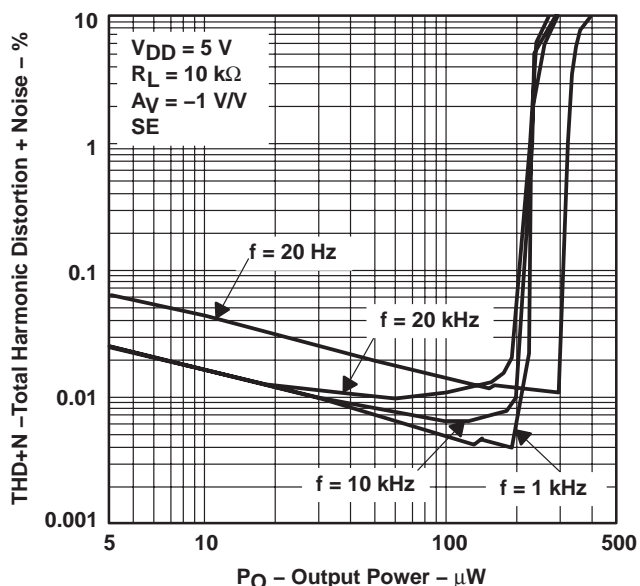
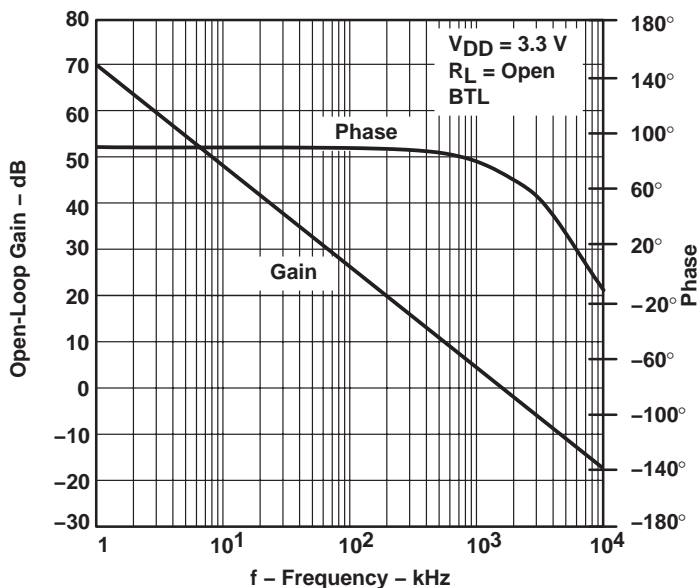

Figure 35



**TYPICAL CHARACTERISTICS**

**OPEN-LOOP GAIN AND PHASE  
 vs  
 FREQUENCY**



**Figure 36**

**OPEN-LOOP GAIN AND PHASE  
 vs  
 FREQUENCY**

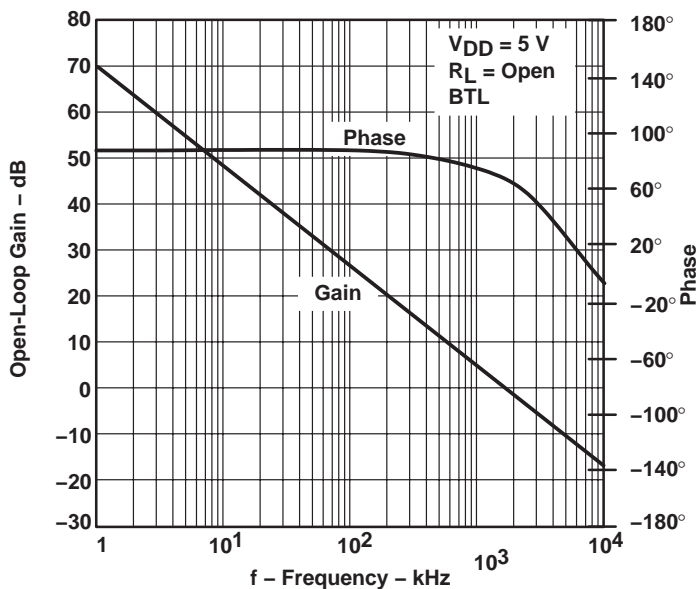

**Figure 37**

# TPA711 700-mW MONO LOW-VOLTAGE AUDIO POWER AMPLIFIER

SLOS230D – NOVEMBER 1998 – REVISED OCTOBER 2002

## TYPICAL CHARACTERISTICS

### CLOSED-LOOP GAIN AND PHASE vs FREQUENCY

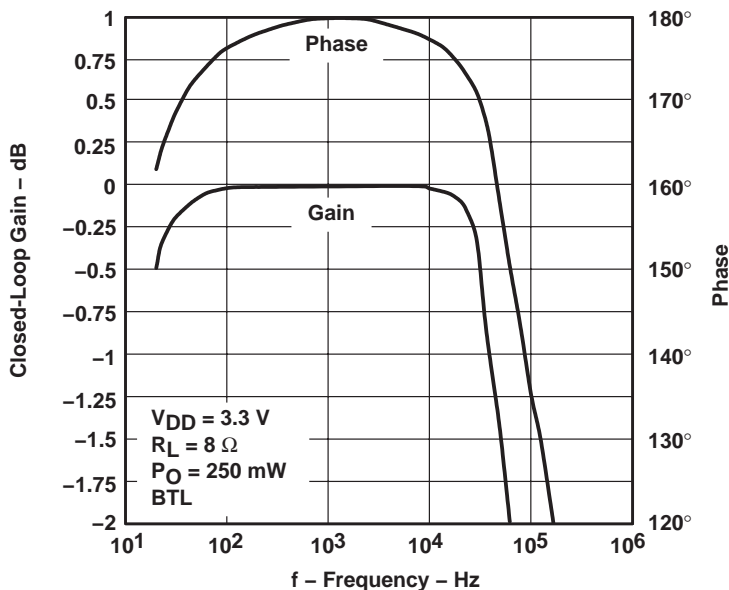

Figure 38

### CLOSED-LOOP GAIN AND PHASE vs FREQUENCY

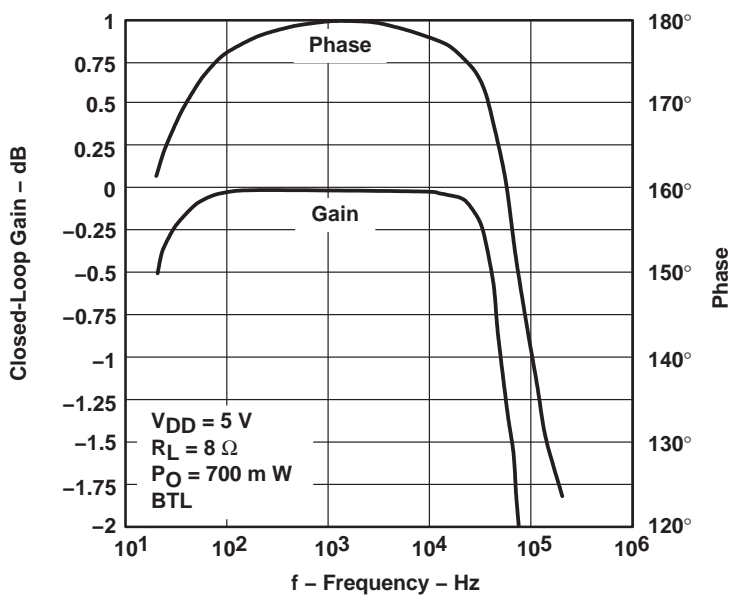

Figure 39





**TYPICAL CHARACTERISTICS**

**CLOSED-LOOP GAIN AND PHASE  
vs  
FREQUENCY**

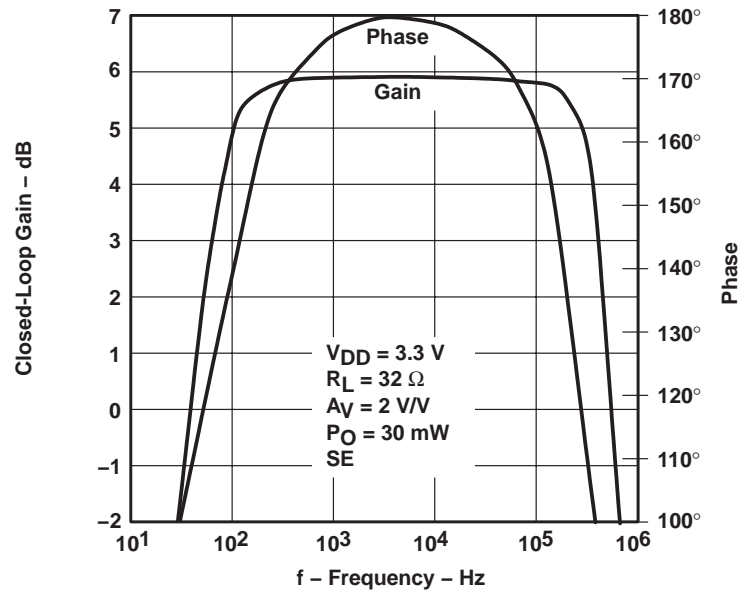

**Figure 40**

**CLOSED-LOOP GAIN AND PHASE  
vs  
FREQUENCY**

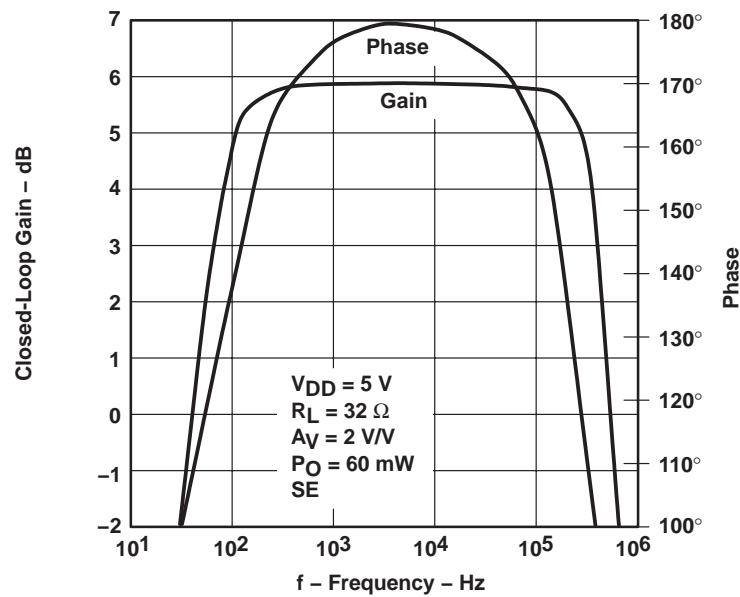

**Figure 41**

# TPA711 700-mW MONO LOW-VOLTAGE AUDIO POWER AMPLIFIER

SLOS230D – NOVEMBER 1998 – REVISED OCTOBER 2002

## TYPICAL CHARACTERISTICS

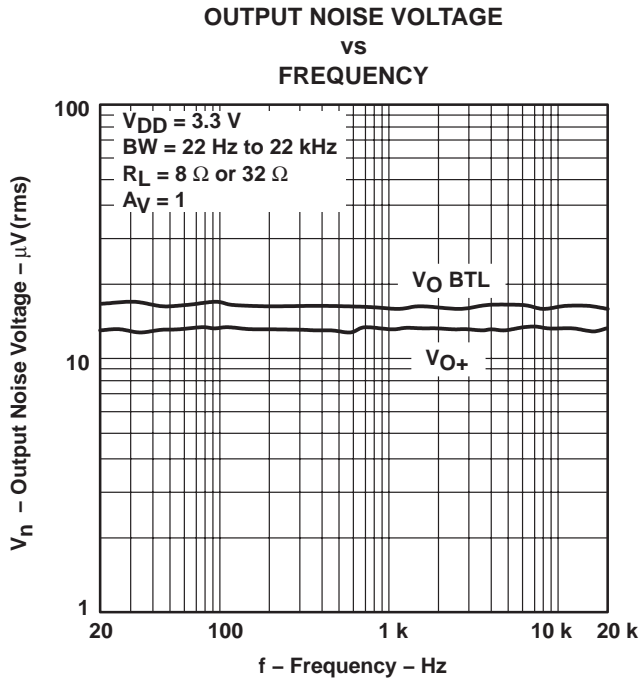

Figure 42

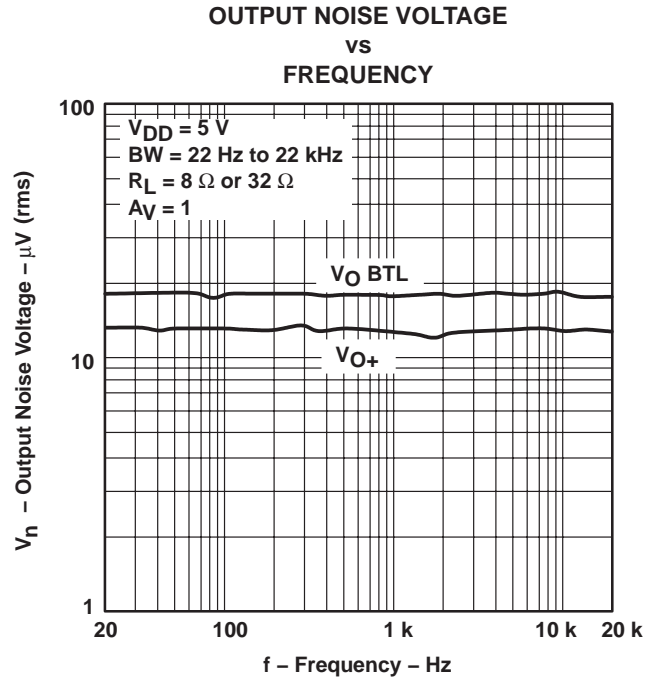

Figure 43

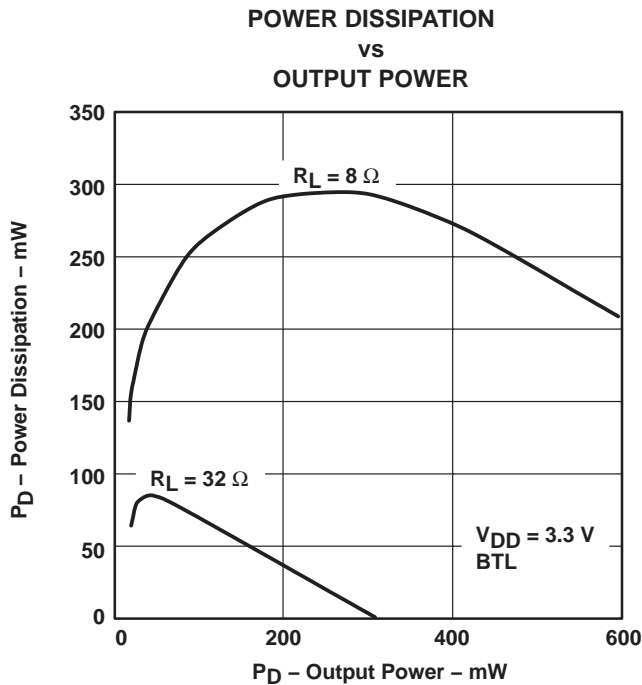

Figure 44

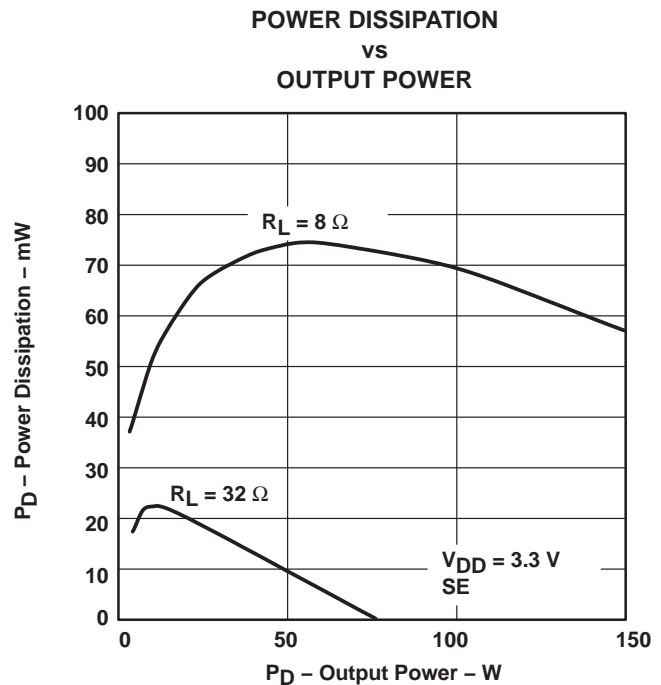
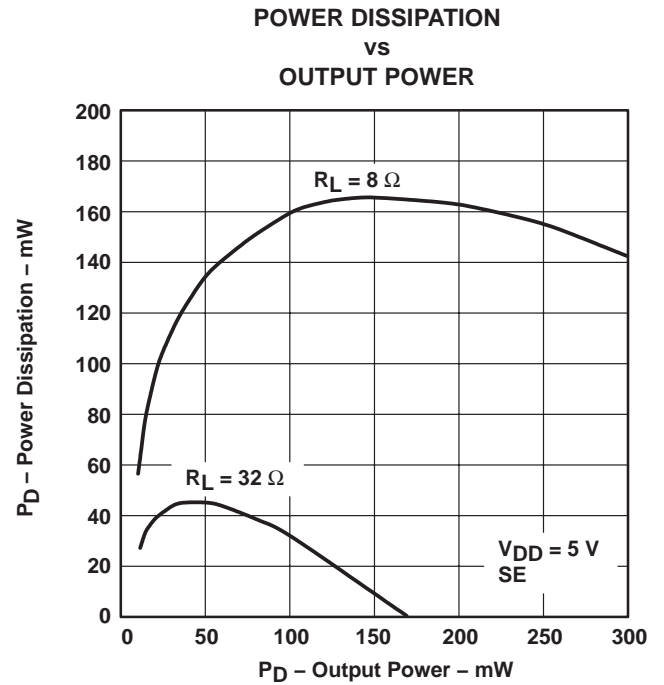
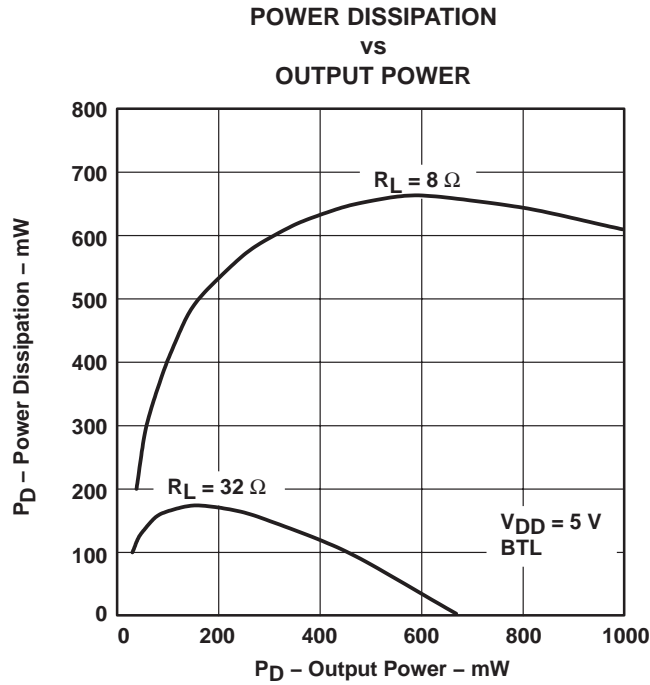

Figure 45

**TYPICAL CHARACTERISTICS**



# TPA711

## 700-mW MONO LOW-VOLTAGE AUDIO POWER AMPLIFIER

SLOS230D – NOVEMBER 1998 – REVISED OCTOBER 2002

### APPLICATION INFORMATION

#### bridged-tied load versus single-ended mode

Figure 48 shows a linear audio power amplifier (APA) in a BTL configuration. The TPA711 BTL amplifier consists of two linear amplifiers driving both ends of the load. There are several potential benefits to this differential drive configuration but initially consider power to the load. The differential drive to the speaker means that as one side is slewing up, the other side is slewing down, and vice versa. This, in effect, doubles the voltage swing on the load as compared to a ground referenced load. Plugging  $2 \times V_{O(PP)}$  into the power equation, where voltage is squared, yields  $4 \times$  the output power from the same supply rail and load impedance (see equation 1).

$$V_{(rms)} = \frac{V_{O(PP)}}{2\sqrt{2}} \tag{1}$$

$$\text{Power} = \frac{V_{(rms)}^2}{R_L}$$

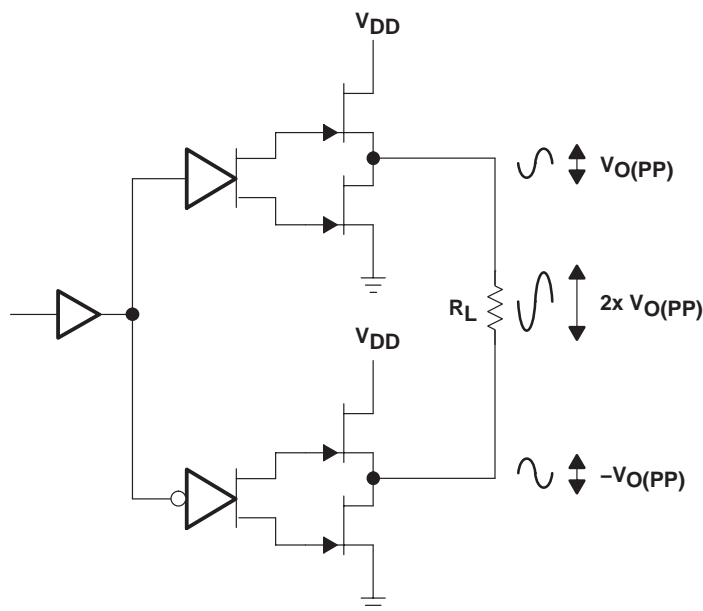

**Figure 48. Bridge-Tied Load Configuration**

In a typical portable handheld equipment sound channel operating at 3.3 V, bridging raises the power into an 8-Ω speaker from a singled-ended (SE, ground reference) limit of 62.5 mW to 250 mW. In sound power that is a 6-dB improvement, which is loudness that can be heard. In addition to increased power there are frequency response concerns. Consider the single-supply SE configuration shown in Figure 49. A coupling capacitor is required to block the dc offset voltage from reaching the load. These capacitors can be quite large (approximately 33 μF to 1000 μF) so they tend to be expensive, heavy, occupy valuable PCB area, and have the additional drawback of limiting low-frequency performance of the system. This frequency-limiting effect is due to the high pass filter network created with the speaker impedance and the coupling capacitance and is calculated with equation 2.

$$f_c = \frac{1}{2\pi R_L C_C} \tag{2}$$

**APPLICATION INFORMATION**

**bridged-tied load versus single-ended mode (continued)**

For example, a 68- $\mu\text{F}$  capacitor with an 8- $\Omega$  speaker would attenuate low frequencies below 293 Hz. The BTL configuration cancels the dc offsets, which eliminates the need for the blocking capacitors. Low-frequency performance is then limited only by the input network and speaker response. Cost and PCB space are also minimized by eliminating the bulky coupling capacitor.

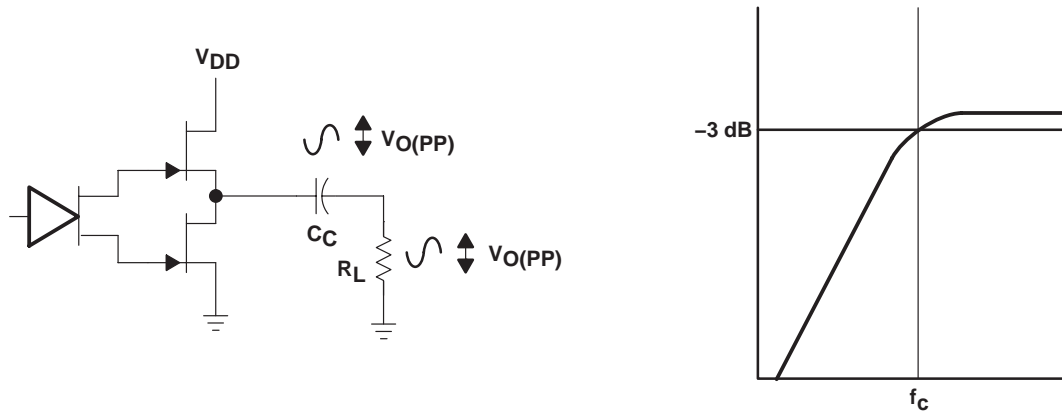

**Figure 49. Single-Ended Configuration and Frequency Response**

Increasing power to the load does carry a penalty of increased internal power dissipation. The increased dissipation is understandable considering that the BTL configuration produces 4 $\times$  the output power of the SE configuration. Internal dissipation versus output power is discussed further in the *thermal considerations* section.

**BTL amplifier efficiency**

Linear amplifiers are notoriously inefficient. The primary cause of these inefficiencies is voltage drop across the output stage transistors. There are two components of the internal voltage drop. One is the headroom or dc voltage drop that varies inversely to output power. The second component is due to the sinewave nature of the output. The total voltage drop can be calculated by subtracting the RMS value of the output voltage from  $V_{DD}$ . The internal voltage drop multiplied by the RMS value of the supply current,  $I_{DD\text{rms}}$ , determines the internal power dissipation of the amplifier.

An easy-to-use equation to calculate efficiency starts out being equal to the ratio of power from the power supply to the power delivered to the load. To accurately calculate the RMS values of power in the load and in the amplifier, the current and voltage waveform shapes must first be understood (see Figure 50).

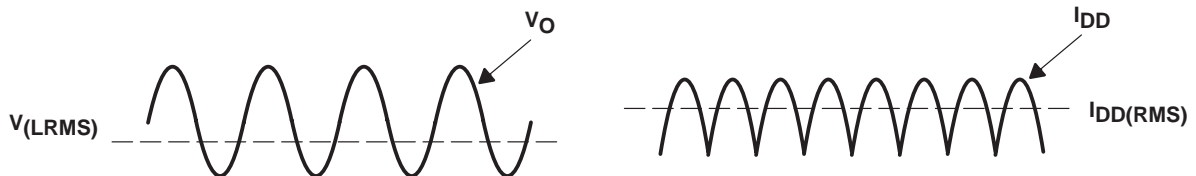

**Figure 50. Voltage and Current Waveforms for BTL Amplifiers**

# TPA711

## 700-mW MONO LOW-VOLTAGE AUDIO POWER AMPLIFIER

SLOS230D – NOVEMBER 1998 – REVISED OCTOBER 2002

### APPLICATION INFORMATION

#### BTL amplifier efficiency (continued)

Although the voltages and currents for SE and BTL are sinusoidal in the load, currents from the supply are very different between SE and BTL configurations. In an SE application the current waveform is a half-wave rectified shape, whereas in BTL it is a full-wave rectified waveform. This means RMS conversion factors are different. Keep in mind that for most of the waveform, both the push and pull transistors are not on at the same time, which supports the fact that each amplifier in the BTL device only draws current from the supply for half the waveform. The following equations are the basis for calculating amplifier efficiency.

$$\text{Efficiency} = \frac{P_L}{P_{\text{SUP}}} \quad (3)$$

where

$$P_L = \frac{V_{L\text{rms}}^2}{R_L} = \frac{V_p^2}{2R_L}$$

$$V_{L\text{rms}} = \frac{V_P}{\sqrt{2}}$$

$$P_{\text{SUP}} = V_{DD} I_{DD\text{rms}} = \frac{V_{DD} 2V_P}{\pi R_L}$$

$$I_{DD\text{rms}} = \frac{2V_P}{\pi R_L}$$

$$\text{Efficiency of a BTL configuration} = \frac{\pi V_P}{4V_{DD}} = \frac{\pi (2 P_L R_L)^{1/2}}{4V_{DD}} \quad (4)$$

Table 1 employs equation 4 to calculate efficiencies for three different output power levels. The efficiency of the amplifier is quite low for lower power levels and rises sharply as power to the load is increased, resulting in a nearly flat internal power dissipation over the normal operating range. The internal dissipation at full output power is less than in the half power range. Calculating the efficiency for a specific system is the key to proper power supply design.

**Table 1. Efficiency Vs Output Power in 3.3-V 8-Ω BTL Systems**

OUTPUT POWER (W)	EFFICIENCY (%)	PEAK VOLTAGE (V)	INTERNAL DISSIPATION (W)
0.125	33.6	1.41	0.26
0.25	47.6	2.00	0.29
0.375	58.3	2.45†	0.28

† High-peak voltage values cause the THD to increase.

A final point to remember about linear amplifiers (either SE or BTL) is how to manipulate the terms in the efficiency equation to utmost advantage when possible. In equation 4,  $V_{DD}$  is in the denominator. This indicates that as  $V_{DD}$  goes down, efficiency goes up.

## APPLICATION INFORMATION

### application schematic

Figure 51 is a schematic diagram of a typical handheld audio application circuit, configured for a gain of  $-10\text{ V/V}$ .

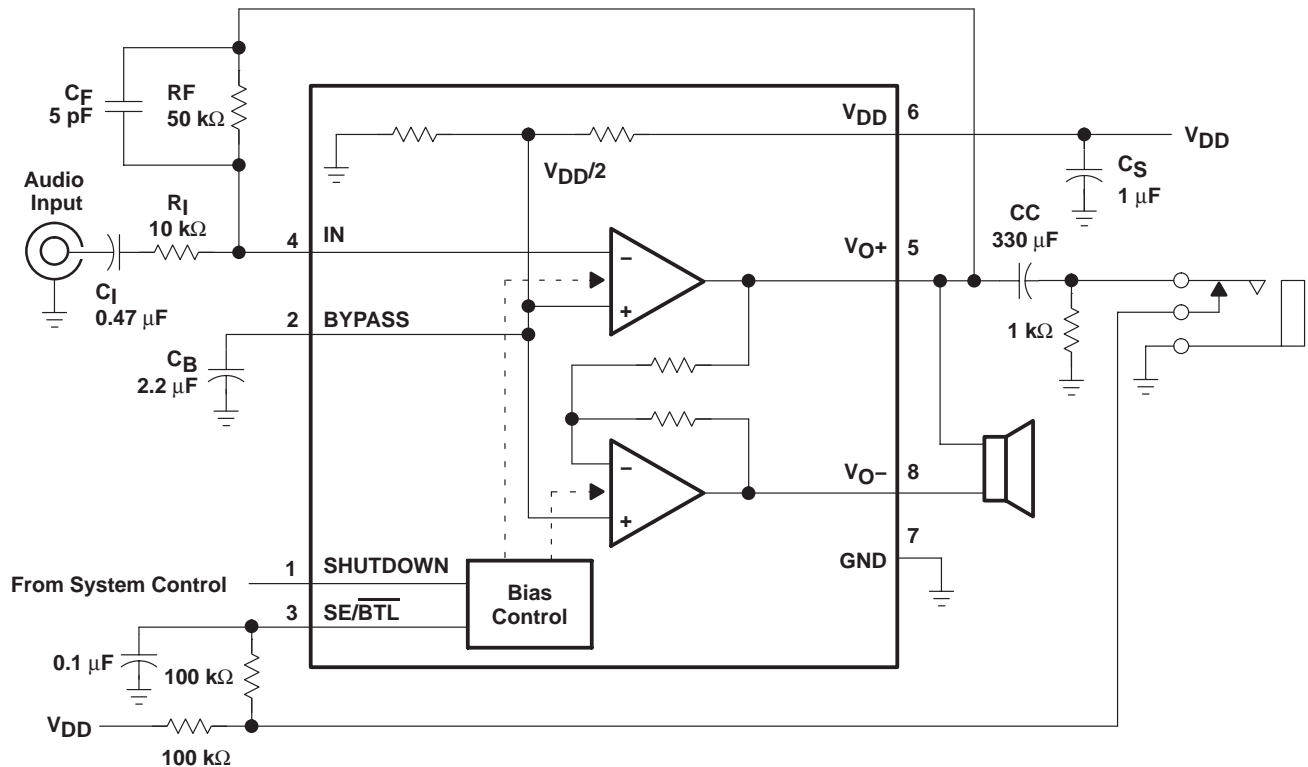

**Figure 51. TPA711 Application Circuit**

The following sections discuss the selection of the components used in Figure 51.

### component selection

#### gain setting resistors, $R_F$ and $R_I$

The gain for each audio input of the TPA711 is set by resistors  $R_F$  and  $R_I$  according to equation 5 for BTL mode.

$$\text{BTL gain} = -2 \left( \frac{R_F}{R_I} \right) \quad (5)$$

BTL mode operation brings about the factor 2 in the gain equation due to the inverting amplifier mirroring the voltage swing across the load. Given that the TPA711 is a MOS amplifier, the input impedance is very high; consequently input leakage currents are not generally a concern, although noise in the circuit increases as the value of  $R_F$  increases. In addition, a certain range of  $R_F$  values is required for proper start-up operation of the amplifier. Taken together it is recommended that the effective impedance seen by the inverting node of the amplifier be set between 5 kΩ and 20 kΩ. The effective impedance is calculated in equation 6.

$$\text{Effective impedance} = \frac{R_F R_I}{R_F + R_I} \quad (6)$$

# TPA711

## 700-mW MONO LOW-VOLTAGE AUDIO POWER AMPLIFIER

SLOS230D – NOVEMBER 1998 – REVISED OCTOBER 2002

### APPLICATION INFORMATION

#### component selection (continued)

As an example consider an input resistance of 10 k $\Omega$  and a feedback resistor of 50 k $\Omega$ . The BTL gain of the amplifier would be  $-10$  V/V and the effective impedance at the inverting terminal would be 8.3 k $\Omega$ , which is well within the recommended range.

For high performance applications, metal film resistors are recommended because they tend to have lower noise levels than carbon resistors. For values of  $R_F$  above 50 k $\Omega$ , the amplifier tends to become unstable due to a pole formed from  $R_F$  and the inherent input capacitance of the MOS input structure. For this reason, a small compensation capacitor of approximately 5 pF should be placed in parallel with  $R_F$  when  $R_F$  is greater than 50 k $\Omega$ . This, in effect, creates a low pass filter network with the cutoff frequency defined in equation 7.

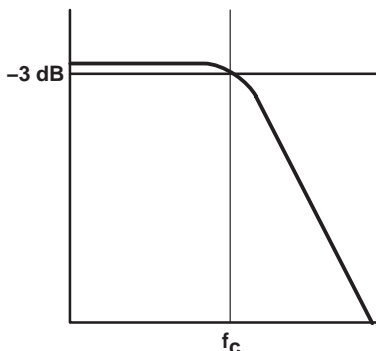

$$f_{c(\text{lowpass})} = \frac{1}{2\pi R_F C_F} \quad (7)$$

For example, if  $R_F$  is 100 k $\Omega$  and  $C_F$  is 5 pF, then  $f_c$  is 318 kHz, which is well outside of the audio range.

#### input capacitor, $C_I$

In the typical application an input capacitor,  $C_I$ , is required to allow the amplifier to bias the input signal to the proper dc level for optimum operation. In this case,  $C_I$  and  $R_I$  form a high-pass filter with the corner frequency determined in equation 8.

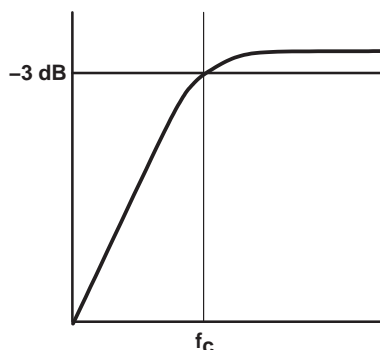

$$f_{c(\text{highpass})} = \frac{1}{2\pi R_I C_I} \quad (8)$$

The value of  $C_I$  is important to consider as it directly affects the bass (low frequency) performance of the circuit. Consider the example where  $R_I$  is 10 k $\Omega$  and the specification calls for a flat bass response down to 40 Hz. Equation 8 is reconfigured as equation 9.

$$C_I = \frac{1}{2\pi R_I f_c} \quad (9)$$



## APPLICATION INFORMATION

### component selection (continued)

In this example,  $C_I$  is  $0.40\ \mu\text{F}$ , so one would likely choose a value in the range of  $0.47\ \mu\text{F}$  to  $1\ \mu\text{F}$ . A further consideration for this capacitor is the leakage path from the input source through the input network ( $R_I$ ,  $C_I$ ) and the feedback resistor ( $R_F$ ) to the load. This leakage current creates a dc offset voltage at the input to the amplifier that reduces useful headroom, especially in high gain applications. For this reason a low-leakage tantalum or ceramic capacitor is the best choice. When polarized capacitors are used, the positive side of the capacitor should face the amplifier input in most applications, as the dc level there is held at  $V_{DD}/2$ , which is likely higher than the source dc level. It is important to confirm the capacitor polarity in the application.

### power supply decoupling, $C_S$

The TPA711 is a high-performance CMOS audio amplifier that requires adequate power supply decoupling to ensure the output total harmonic distortion (THD) is as low as possible. Power supply decoupling also prevents oscillations for long lead lengths between the amplifier and the speaker. The optimum decoupling is achieved by using two capacitors of different types that target different types of noise on the power supply leads. For higher frequency transients, spikes, or digital hash on the line, a good low equivalent-series-resistance (ESR) ceramic capacitor, typically  $0.1\ \mu\text{F}$  placed as close as possible to the device  $V_{DD}$  lead, works best. For filtering lower-frequency noise signals, a larger aluminum electrolytic capacitor of  $10\ \mu\text{F}$  or greater placed near the audio power amplifier is recommended.

### midrail bypass capacitor, $C_B$

The midrail bypass capacitor,  $C_B$ , is the most critical capacitor and serves several important functions. During start-up or recovery from shutdown mode,  $C_B$  determines the rate at which the amplifier starts up. The second function is to reduce noise produced by the power supply caused by coupling into the output drive signal. This noise is from the midrail generation circuit internal to the amplifier, which appears as degraded PSRR THD + N. The capacitor is fed from a  $250\text{-k}\Omega$  source inside the amplifier. To keep the start-up pop as low as possible, the relationship shown in equation 10 should be maintained. This insures the input capacitor is fully charged before the bypass capacitor is fully charged and the amplifier starts up.

$$\frac{10}{(C_B \times 250\ \text{k}\Omega)} \leq \frac{1}{(R_F + R_I) C_I} \quad (10)$$

As an example, consider a circuit where  $C_B$  is  $2.2\ \mu\text{F}$ ,  $C_I$  is  $0.47\ \mu\text{F}$ ,  $R_F$  is  $50\ \text{k}\Omega$ , and  $R_I$  is  $10\ \text{k}\Omega$ . Inserting these values into the equation 10 we get:

$$18.2 \leq 35.5$$

which satisfies the rule. Bypass capacitor,  $C_B$ , values of  $0.1\ \mu\text{F}$  to  $2.2\ \mu\text{F}$  ceramic or tantalum low-ESR capacitors are recommended for the best THD and noise performance.

### single-ended operation

In SE mode (see Figure 51), the load is driven from the primary amplifier output ( $V_{O+}$ , terminal 5).

In SE mode the gain is set by the  $R_F$  and  $R_I$  resistors and is shown in equation 11. Since the inverting amplifier is not used to mirror the voltage swing on the load, the factor of 2, from equation 5, is not included.

$$\text{SE Gain} = - \left( \frac{R_F}{R_I} \right) \quad (11)$$

# TPA711

## 700-mW MONO LOW-VOLTAGE AUDIO POWER AMPLIFIER

SLOS230D – NOVEMBER 1998 – REVISED OCTOBER 2002

### APPLICATION INFORMATION

#### component selection (continued)

The output coupling capacitor required in single-supply SE mode also places additional constraints on the selection of other components in the amplifier circuit. The rules described earlier still hold with the addition of the following relationship:

$$\frac{10}{(C_B \times 250 \text{ k}\Omega)} \leq \frac{1}{(R_F + R_I) C_I} \ll \frac{1}{R_L C_C} \quad (12)$$

#### output coupling capacitor, $C_C$

In the typical single-supply SE configuration, an output coupling capacitor ( $C_C$ ) is required to block the dc bias at the output of the amplifier, thus preventing dc currents in the load. As with the input coupling capacitor, the output coupling capacitor and impedance of the load form a high-pass filter governed by equation 13.

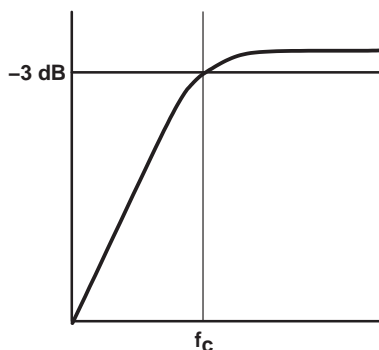

$$f_{c(\text{high})} = \frac{1}{2\pi R_L C_C} \quad (13)$$

The main disadvantage, from a performance standpoint, is the load impedances are typically small, which drives the low-frequency corner higher, degrading the bass response. Large values of  $C_C$  are required to pass low frequencies into the load. Consider the example where a  $C_C$  of 330  $\mu\text{F}$  is chosen and loads vary from 4  $\Omega$ , 8  $\Omega$ , 32  $\Omega$ , and 47 k $\Omega$ . Table 2 summarizes the frequency response characteristics of each configuration.

**Table 2. Common Load Impedances Vs Low Frequency Output Characteristics in SE Mode**

$R_L$	$C_C$	LOWEST FREQUENCY
8 $\Omega$	330 $\mu\text{F}$	60 Hz
32 $\Omega$	330 $\mu\text{F}$	15 Hz
47,000 $\Omega$	330 $\mu\text{F}$	0.01 Hz

As Table 2 indicates, an 8- $\Omega$  load is adequate, earphone response is good, and drive into line level inputs (a home stereo for example) is exceptional.

## APPLICATION INFORMATION

### SE/BTL operation

The ability of the TPA711 to easily switch between BTL and SE modes is one of its most important cost-saving features. This feature eliminates the requirement for an additional earphone amplifier in applications where internal speakers are driven in BTL mode but external earphone or speaker must be accommodated. Internal to the TPA711, two separate amplifiers drive  $V_{O+}$  and  $V_{O-}$ . The SE/BTL input (terminal 3) controls the operation of the follower amplifier that drives  $V_{O-}$  (terminal 8). When SE/BTL is held low, the amplifier is on and the TPA711 is in the BTL mode. When SE/BTL is held high, the  $V_{O-}$  amplifier is in a high output impedance state, which configures the TPA711 as an SE driver from  $V_{O+}$  (terminal 5).  $I_{DD}$  is reduced by approximately one-half in SE mode. Control of the SE/BTL input can be from a logic-level TTL source or, more typically, from a resistor divider network as shown in Figure 52.

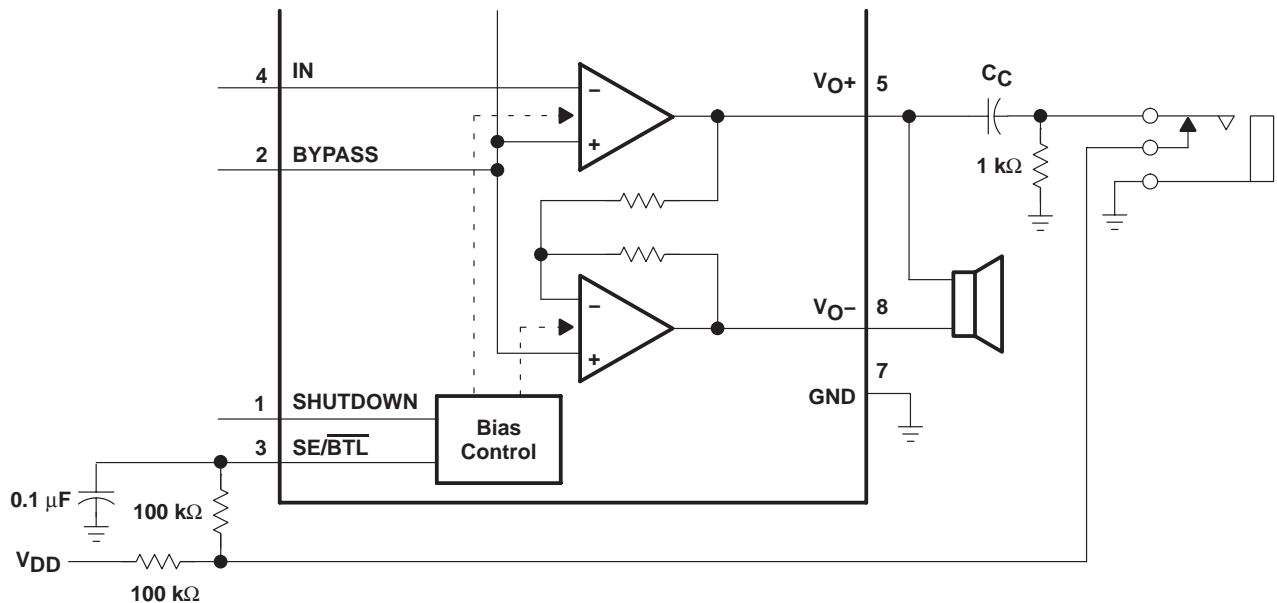

**Figure 52. TPA711 Resistor Divider Network Circuit**

Using a readily available 1/8-in. (3.5 mm) mono earphone jack, the control switch is closed when no plug is inserted. When closed, the 100-kΩ/1-kΩ divider pulls the SE/BTL input low. When a plug is inserted, the 1-kΩ resistor is disconnected and the SE/BTL input is pulled high. When the input goes high, the  $V_{O-}$  amplifier is shut down causing the BTL speaker to mute (virtually open-circuits the speaker). The  $V_{O+}$  amplifier then drives through the output capacitor ( $C_C$ ) into the earphone jack.

### using low-ESR capacitors

Low-ESR capacitors are recommended throughout this applications section. A real (as opposed to ideal) capacitor can be modeled simply as a resistor in series with an ideal capacitor. The voltage drop across this resistor minimizes the beneficial effects of the capacitor in the circuit. The lower the equivalent value of this resistance the more the real capacitor behaves like an ideal capacitor.

# TPA711

## 700-mW MONO LOW-VOLTAGE AUDIO POWER AMPLIFIER

SLOS230D – NOVEMBER 1998 – REVISED OCTOBER 2002

### APPLICATION INFORMATION

#### 5-V versus 3.3-V operation

The TPA711 operates over a supply range of 2.5 V to 5.5 V. This data sheet provides full specifications for 5-V and 3.3-V operation, as these are considered to be the two most common standard voltages. There are no special considerations for 3.3-V versus 5-V operation with respect to supply bypassing, gain setting, or stability. The most important consideration is that of output power. Each amplifier in TPA711 can produce a maximum voltage swing of  $V_{DD} - 1$  V. This means, for 3.3-V operation, clipping starts to occur when  $V_{O(PP)} = 2.3$  V as opposed to  $V_{O(PP)} = 4$  V at 5 V. The reduced voltage swing subsequently reduces maximum output power into an 8- $\Omega$  load before distortion becomes significant.

Operation from 3.3-V supplies, as can be shown from the efficiency formula in equation 4, consumes approximately two-thirds the supply power of operation from 5-V supplies for a given output-power level.

#### headroom and thermal considerations

Linear power amplifiers dissipate a significant amount of heat in the package under normal operating conditions. A typical music CD requires 12 dB to 15 dB of dynamic headroom to pass the loudest portions without distortion as compared with the average power output. From the TPA711 data sheet, one can see that when the TPA711 is operating from a 5-V supply into a 8- $\Omega$  speaker that 700 mW peaks are available. Converting watts to dB:

$$P_{dB} = 10\text{Log}\left(\frac{P_W}{P_{ref}}\right) = 10\text{Log}\left(\frac{700\text{ mW}}{1\text{W}}\right) = -1.5\text{ dB}$$

Subtracting the headroom restriction to obtain the average listening level without distortion yields:

- 1.5 dB – 15 dB = -16.5 (15 dB headroom)
- 1.5 dB – 12 dB = -13.5 (12 dB headroom)
- 1.5 dB – 9 dB = -10.5 (9 dB headroom)
- 1.5 dB – 6 dB = -7.5 (6 dB headroom)
- 1.5 dB – 3 dB = -4.5 (3 dB headroom)

Converting dB back into watts:

$$\begin{aligned} P_W &= 10^{P_{dB}/10} \times P_{ref} \\ &= 22\text{ mW (15 dB headroom)} \\ &= 44\text{ mW (12 dB headroom)} \\ &= 88\text{ mW (9 dB headroom)} \\ &= 175\text{ mW (6 dB headroom)} \\ &= 350\text{ mW (3 dB headroom)} \end{aligned}$$

# TPA711 700-mW MONO LOW-VOLTAGE AUDIO POWER AMPLIFIER

SLOS230D – NOVEMBER 1998 – REVISED OCTOBER 2002

## APPLICATION INFORMATION

### headroom and thermal considerations (continued)

This is valuable information to consider when attempting to estimate the heat dissipation requirements for the amplifier system. Comparing the absolute worst case, which is 700 mW of continuous power output with 0 dB of headroom, against 12 dB and 15 dB applications drastically affects maximum ambient temperature ratings for the system. Using the power dissipation curves for a 5-V, 8- $\Omega$  system, the internal dissipation in the TPA711 and maximum ambient temperatures is shown in Table 3.

**Table 3. TPA711 Power Rating, 5-V, 8- $\Omega$ , BTL**

PEAK OUTPUT POWER (mW)	AVERAGE OUTPUT POWER	POWER DISSIPATION (mW)	D PACKAGE (SOIC)	DGN PACKAGE (MSOP)
			MAXIMUM AMBIENT TEMPERATURE	MAXIMUM AMBIENT TEMPERATURE
700	700 mW	675	34°C	110°C
700	350 mW (3 dB)	595	47°C	115°C
700	176 mW (6 dB)	475	68°C	122°C
700	88 mW (9 dB)	350	89°C	125°C
700	44 mW (12 dB)	225	111°C	125°C

Table 3 shows that the TPA711 can be used to its full 700-mW rating without any heat sinking in still air up to 110°C and 34°C for the DGN package (MSOP) and D package (SOIC) respectively.

**PACKAGING INFORMATION**

Orderable Device	Status (1)	Package Type	Package Drawing	Pins	Package Qty	Eco Plan (2)	Lead finish/ Ball material (6)	MSL Peak Temp (3)	Op Temp (°C)	Device Marking (4/5)	Samples
TPA711D	ACTIVE	SOIC	D	8	75	RoHS & Green	NIPDAU	Level-1-260C-UNLIM	-40 to 85	711	<a href="#">Samples</a>
TPA711DG4	ACTIVE	SOIC	D	8	75	RoHS & Green	NIPDAU	Level-1-260C-UNLIM	-40 to 85	711	<a href="#">Samples</a>
TPA711DGN	ACTIVE	HVSSOP	DGN	8	80	RoHS & Green	NIPDAU   NIPDAUAG	Level-1-260C-UNLIM	-40 to 85	ABB	<a href="#">Samples</a>
TPA711DGNR	ACTIVE	HVSSOP	DGN	8	2500	RoHS & Green	NIPDAU   NIPDAUAG	Level-1-260C-UNLIM	-40 to 85	ABB	<a href="#">Samples</a>
TPA711DR	ACTIVE	SOIC	D	8	2500	RoHS & Green	NIPDAU	Level-1-260C-UNLIM	-40 to 85	711	<a href="#">Samples</a>

(1) The marketing status values are defined as follows:

**ACTIVE:** Product device recommended for new designs.

**LIFEBUY:** TI has announced that the device will be discontinued, and a lifetime-buy period is in effect.

**NRND:** Not recommended for new designs. Device is in production to support existing customers, but TI does not recommend using this part in a new design.

**PREVIEW:** Device has been announced but is not in production. Samples may or may not be available.

**OBSELETE:** TI has discontinued the production of the device.

(2) **RoHS:** TI defines "RoHS" to mean semiconductor products that are compliant with the current EU RoHS requirements for all 10 RoHS substances, including the requirement that RoHS substance do not exceed 0.1% by weight in homogeneous materials. Where designed to be soldered at high temperatures, "RoHS" products are suitable for use in specified lead-free processes. TI may reference these types of products as "Pb-Free".

**RoHS Exempt:** TI defines "RoHS Exempt" to mean products that contain lead but are compliant with EU RoHS pursuant to a specific EU RoHS exemption.

**Green:** TI defines "Green" to mean the content of Chlorine (Cl) and Bromine (Br) based flame retardants meet JS709B low halogen requirements of <=1000ppm threshold. Antimony trioxide based flame retardants must also meet the <=1000ppm threshold requirement.

(3) MSL, Peak Temp. - The Moisture Sensitivity Level rating according to the JEDEC industry standard classifications, and peak solder temperature.

(4) There may be additional marking, which relates to the logo, the lot trace code information, or the environmental category on the device.

(5) Multiple Device Markings will be inside parentheses. Only one Device Marking contained in parentheses and separated by a "~" will appear on a device. If a line is indented then it is a continuation of the previous line and the two combined represent the entire Device Marking for that device.

(6) Lead finish/Ball material - Orderable Devices may have multiple material finish options. Finish options are separated by a vertical ruled line. Lead finish/Ball material values may wrap to two lines if the finish value exceeds the maximum column width.

**Important Information and Disclaimer:** The information provided on this page represents TI's knowledge and belief as of the date that it is provided. TI bases its knowledge and belief on information provided by third parties, and makes no representation or warranty as to the accuracy of such information. Efforts are underway to better integrate information from third parties. TI has taken and continues to take reasonable steps to provide representative and accurate information but may not have conducted destructive testing or chemical analysis on incoming materials and chemicals. TI and TI suppliers consider certain information to be proprietary, and thus CAS numbers and other limited information may not be available for release.

In no event shall TI's liability arising out of such information exceed the total purchase price of the TI part(s) at issue in this document sold by TI to Customer on an annual basis.

## TAPE AND REEL INFORMATION



### QUADRANT ASSIGNMENTS FOR PIN 1 ORIENTATION IN TAPE



\*All dimensions are nominal

Device	Package Type	Package Drawing	Pins	SPQ	Reel Diameter (mm)	Reel Width W1 (mm)	A0 (mm)	B0 (mm)	K0 (mm)	P1 (mm)	W (mm)	Pin1 Quadrant
TPA711DGNR	HVSSOP	DGN	8	2500	330.0	12.4	5.3	3.4	1.4	8.0	12.0	Q1
TPA711DGNR	HVSSOP	DGN	8	2500	330.0	12.4	5.3	3.4	1.4	8.0	12.0	Q1
TPA711DR	SOIC	D	8	2500	330.0	12.4	6.4	5.2	2.1	8.0	12.0	Q1



**TAPE AND REEL BOX DIMENSIONS**

\*All dimensions are nominal

Device	Package Type	Package Drawing	Pins	SPQ	Length (mm)	Width (mm)	Height (mm)
TPA711DGNR	HVSSOP	DGN	8	2500	358.0	335.0	35.0
TPA711DGNR	HVSSOP	DGN	8	2500	364.0	364.0	27.0
TPA711DR	SOIC	D	8	2500	350.0	350.0	43.0

## GENERIC PACKAGE VIEW

**DGN 8**

**PowerPAD VSSOP - 1.1 mm max height**

3 x 3, 0.65 mm pitch

SMALL OUTLINE PACKAGE

This image is a representation of the package family, actual package may vary.  
Refer to the product data sheet for package details.

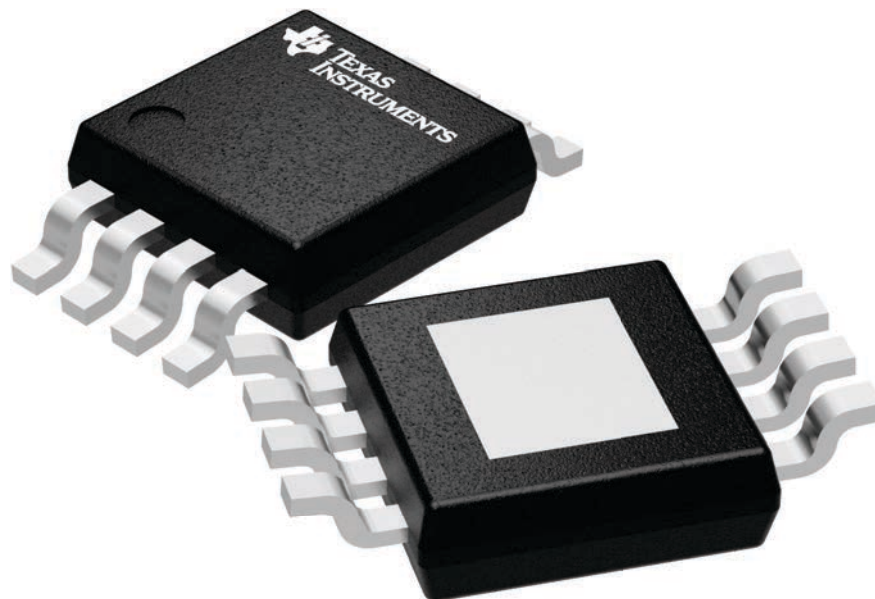

4225482/A



4225481/A 11/2019

PowerPAD is a trademark of Texas Instruments.

NOTES:

1. All linear dimensions are in millimeters. Any dimensions in parenthesis are for reference only. Dimensioning and tolerancing per ASME Y14.5M.
2. This drawing is subject to change without notice.
3. This dimension does not include mold flash, protrusions, or gate burrs. Mold flash, protrusions, or gate burrs shall not exceed 0.15 mm per side.
4. This dimension does not include interlead flash. Interlead flash shall not exceed 0.25 mm per side.
5. Reference JEDEC registration MO-187.

# EXAMPLE BOARD LAYOUT

DGN0008D

PowerPAD™ VSSOP - 1.1 mm max height

SMALL OUTLINE PACKAGE



LAND PATTERN EXAMPLE  
EXPOSED METAL SHOWN  
SCALE: 15X

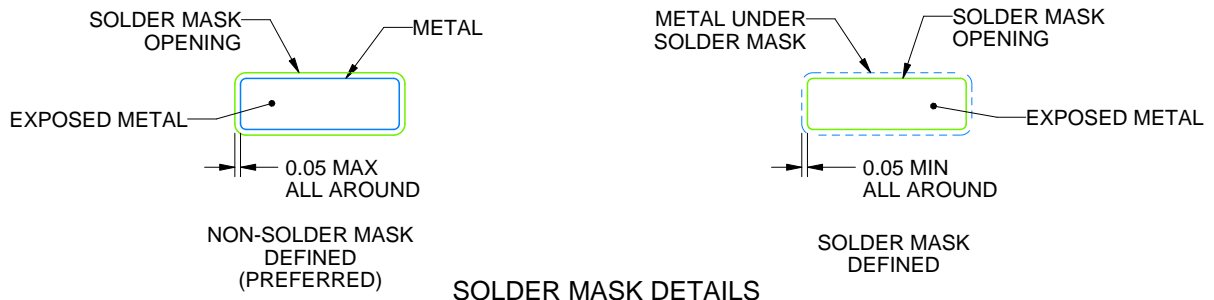

SOLDER MASK DETAILS

4225481/A 11/2019

NOTES: (continued)

- 6. Publication IPC-7351 may have alternate designs.
- 7. Solder mask tolerances between and around signal pads can vary based on board fabrication site.
- 8. Vias are optional depending on application, refer to device data sheet. If any vias are implemented, refer to their locations shown on this view. It is recommended that vias under paste be filled, plugged or tented.
- 9. Size of metal pad may vary due to creepage requirement.

# EXAMPLE STENCIL DESIGN

DGN0008D

PowerPAD™ VSSOP - 1.1 mm max height

SMALL OUTLINE PACKAGE

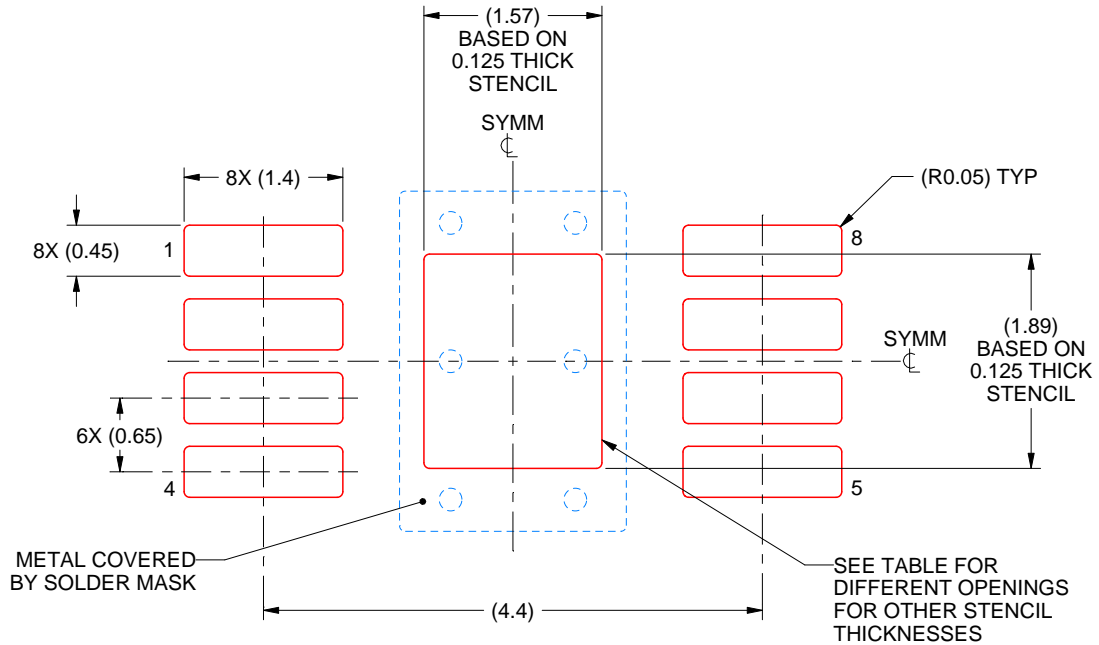

**SOLDER PASTE EXAMPLE**  
 EXPOSED PAD 9:  
 100% PRINTED SOLDER COVERAGE BY AREA  
 SCALE: 15X

STENCIL THICKNESS	SOLDER STENCIL OPENING
0.1	1.76 X 2.11
0.125	1.57 X 1.89 (SHOWN)
0.15	1.43 X 1.73
0.175	1.33 X 1.60

4225481/A 11/2019

NOTES: (continued)

- 10. Laser cutting apertures with trapezoidal walls and rounded corners may offer better paste release. IPC-7525 may have alternate design recommendations.
- 11. Board assembly site may have different recommendations for stencil design.

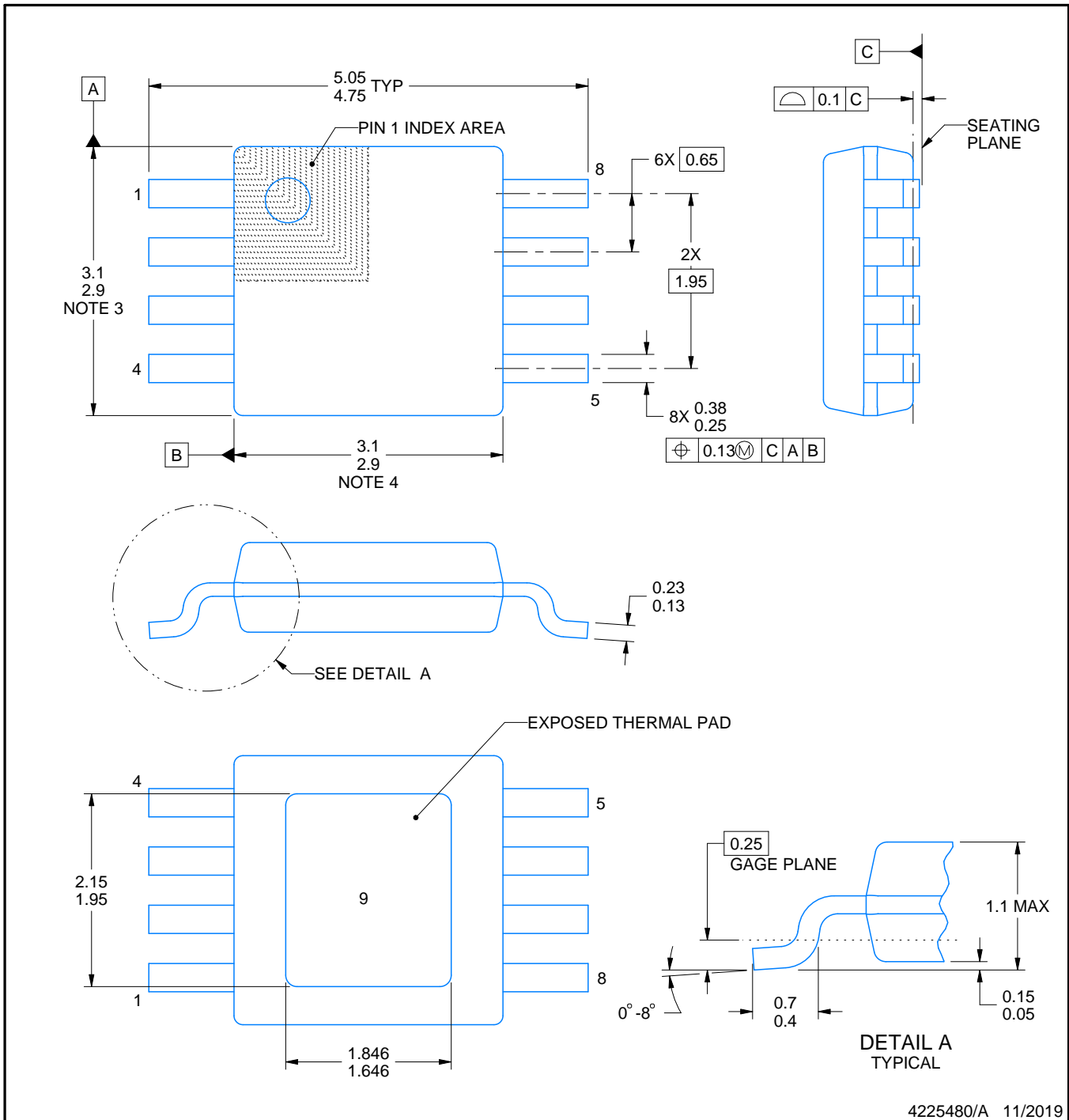
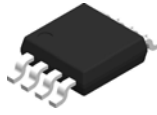

4225480/A 11/2019

NOTES:

PowerPAD is a trademark of Texas Instruments.

1. All linear dimensions are in millimeters. Any dimensions in parenthesis are for reference only. Dimensioning and tolerancing per ASME Y14.5M.
2. This drawing is subject to change without notice.
3. This dimension does not include mold flash, protrusions, or gate burrs. Mold flash, protrusions, or gate burrs shall not exceed 0.15 mm per side.
4. This dimension does not include interlead flash. Interlead flash shall not exceed 0.25 mm per side.
5. Reference JEDEC registration MO-187.

# EXAMPLE BOARD LAYOUT

DGN0008G

PowerPAD™ VSSOP - 1.1 mm max height

SMALL OUTLINE PACKAGE

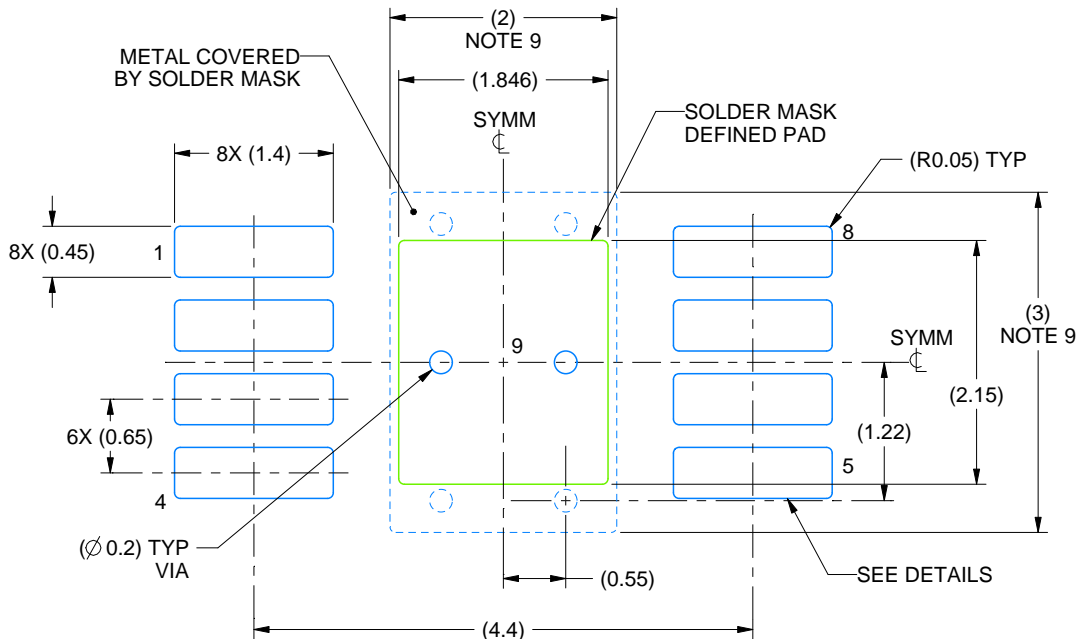

LAND PATTERN EXAMPLE  
EXPOSED METAL SHOWN  
SCALE: 15X



SOLDER MASK DETAILS

4225480/A 11/2019

NOTES: (continued)

6. Publication IPC-7351 may have alternate designs.
7. Solder mask tolerances between and around signal pads can vary based on board fabrication site.
8. Vias are optional depending on application, refer to device data sheet. If any vias are implemented, refer to their locations shown on this view. It is recommended that vias under paste be filled, plugged or tented.
9. Size of metal pad may vary due to creepage requirement.

# EXAMPLE STENCIL DESIGN

DGN0008G

PowerPAD™ VSSOP - 1.1 mm max height

SMALL OUTLINE PACKAGE

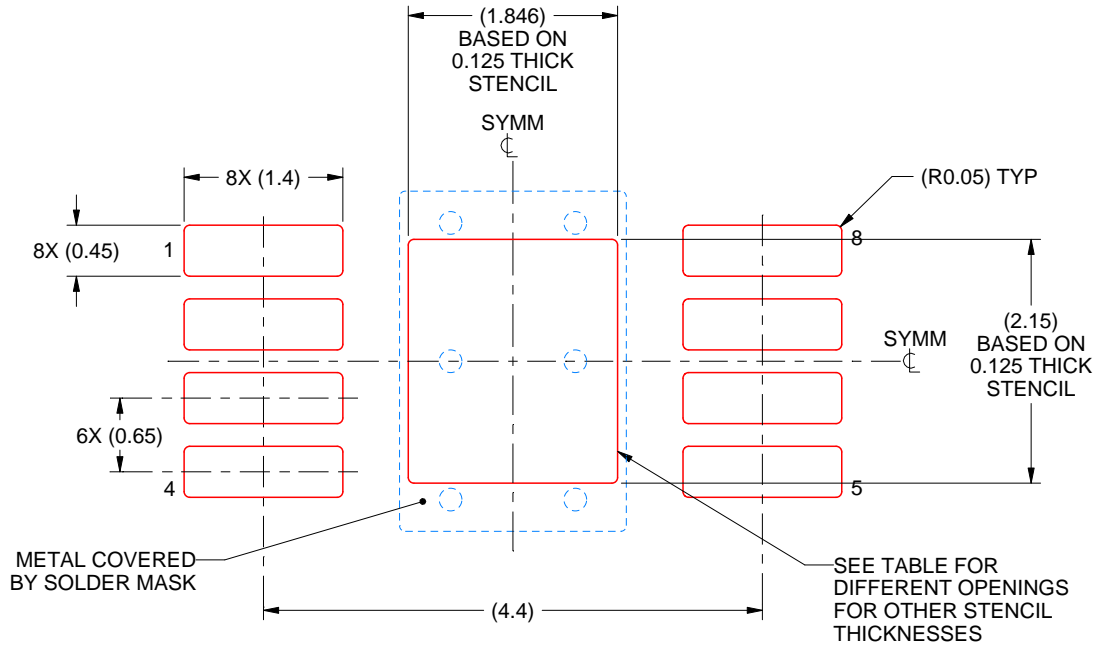

**SOLDER PASTE EXAMPLE**  
 EXPOSED PAD 9:  
 100% PRINTED SOLDER COVERAGE BY AREA  
 SCALE: 15X

STENCIL THICKNESS	SOLDER STENCIL OPENING
0.1	2.06 X 2.40
0.125	1.846 X 2.15 (SHOWN)
0.15	1.69 X 1.96
0.175	1.56 X 1.82

4225480/A 11/2019

NOTES: (continued)

10. Laser cutting apertures with trapezoidal walls and rounded corners may offer better paste release. IPC-7525 may have alternate design recommendations.
11. Board assembly site may have different recommendations for stencil design.





D0008A

# PACKAGE OUTLINE

SOIC - 1.75 mm max height

SMALL OUTLINE INTEGRATED CIRCUIT



4214825/C 02/2019

### NOTES:

- Linear dimensions are in inches [millimeters]. Dimensions in parenthesis are for reference only. Controlling dimensions are in inches. Dimensioning and tolerancing per ASME Y14.5M.
- This drawing is subject to change without notice.
- This dimension does not include mold flash, protrusions, or gate burrs. Mold flash, protrusions, or gate burrs shall not exceed  $.006$  [0.15] per side.
- This dimension does not include interlead flash.
- Reference JEDEC registration MS-012, variation AA.

# EXAMPLE BOARD LAYOUT

D0008A

SOIC - 1.75 mm max height

SMALL OUTLINE INTEGRATED CIRCUIT



LAND PATTERN EXAMPLE  
 EXPOSED METAL SHOWN  
 SCALE:8X



SOLDER MASK DETAILS

4214825/C 02/2019

NOTES: (continued)

- 6. Publication IPC-7351 may have alternate designs.
- 7. Solder mask tolerances between and around signal pads can vary based on board fabrication site.

# EXAMPLE STENCIL DESIGN

D0008A

SOIC - 1.75 mm max height

SMALL OUTLINE INTEGRATED CIRCUIT



SOLDER PASTE EXAMPLE  
BASED ON .005 INCH [0.125 MM] THICK STENCIL  
SCALE:8X

4214825/C 02/2019

NOTES: (continued)

8. Laser cutting apertures with trapezoidal walls and rounded corners may offer better paste release. IPC-7525 may have alternate design recommendations.
9. Board assembly site may have different recommendations for stencil design.

## IMPORTANT NOTICE AND DISCLAIMER

TI PROVIDES TECHNICAL AND RELIABILITY DATA (INCLUDING DATASHEETS), DESIGN RESOURCES (INCLUDING REFERENCE DESIGNS), APPLICATION OR OTHER DESIGN ADVICE, WEB TOOLS, SAFETY INFORMATION, AND OTHER RESOURCES "AS IS" AND WITH ALL FAULTS, AND DISCLAIMS ALL WARRANTIES, EXPRESS AND IMPLIED, INCLUDING WITHOUT LIMITATION ANY IMPLIED WARRANTIES OF MERCHANTABILITY, FITNESS FOR A PARTICULAR PURPOSE OR NON-INFRINGEMENT OF THIRD PARTY INTELLECTUAL PROPERTY RIGHTS.

These resources are intended for skilled developers designing with TI products. You are solely responsible for (1) selecting the appropriate TI products for your application, (2) designing, validating and testing your application, and (3) ensuring your application meets applicable standards, and any other safety, security, or other requirements. These resources are subject to change without notice. TI grants you permission to use these resources only for development of an application that uses the TI products described in the resource. Other reproduction and display of these resources is prohibited. No license is granted to any other TI intellectual property right or to any third party intellectual property right. TI disclaims responsibility for, and you will fully indemnify TI and its representatives against, any claims, damages, costs, losses, and liabilities arising out of your use of these resources.

TI's products are provided subject to TI's Terms of Sale ([www.ti.com/legal/termsofsale.html](http://www.ti.com/legal/termsofsale.html)) or other applicable terms available either on [ti.com](http://ti.com) or provided in conjunction with such TI products. TI's provision of these resources does not expand or otherwise alter TI's applicable warranties or warranty disclaimers for TI products.

Mailing Address: Texas Instruments, Post Office Box 655303, Dallas, Texas 75265  
Copyright © 2020, Texas Instruments Incorporated