

## Dual Buffer Driver With 3-State Outputs

Check for Samples: [SN74LVC2G240](#)

### FEATURES

- Available in the Texas Instruments NanoFree™ Package
- Supports 5-V  $V_{CC}$  Operation
- Inputs Accept Voltages to 5.5 V
- Max  $t_{pd}$  of 4.6 ns at 3.3 V
- Low Power Consumption, 10- $\mu$ A Max  $I_{CC}$
- $\pm 24$ -mA Output Drive at 3.3 V
- Typical  $V_{OLP}$  (Output Ground Bounce)  $< 0.8$  V at  $V_{CC} = 3.3$  V,  $T_A = 25^\circ\text{C}$
- Typical  $V_{OHV}$  (Output  $V_{OH}$  Undershoot)  $> 2$  V at  $V_{CC} = 3.3$  V,  $T_A = 25^\circ\text{C}$
- $I_{off}$  Supports Live Insertion, Partial-Power-Down Mode, and Back-Drive Protection
- Can Be Used as a Down Translator to Translate Inputs From a Max of 5.5 V Down to the  $V_{CC}$  Level
- Latch-Up Performance Exceeds 100 mA Per JESD 78, Class II
- ESD Protection Exceeds JESD 22
  - 2000-V Human-Body Model (A114-A)
  - 1000-V Charged-Device Model (C101)

### DESCRIPTION

This dual buffer driver is designed for 1.65-V to 5.5-V  $V_{CC}$  operation.

The SN74LVC2G240 device is designed specifically to improve the performance and density of 3-state memory address drivers, clock drivers, and bus-oriented receivers and transmitters.

NanoFree™ package technology is a major breakthrough in IC packaging concepts, using the die as the package.

This device is organized as two 1-bit buffers/drivers with separate output-enable (OE) inputs. When OE is low, the device passes data from the A input to the Y output. When OE is high, the outputs are in the high-impedance state.

To ensure the high-impedance state during power up or power down, OE should be tied to  $V_{CC}$  through a pullup resistor; the minimum value of the resistor is determined by the current-sinking capability of the driver.

This device is fully specified for partial-power-down applications using  $I_{off}$ . The  $I_{off}$  circuitry disables the outputs, preventing damaging current backflow through the device when it is powered down.

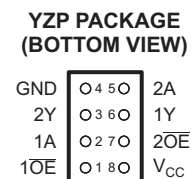
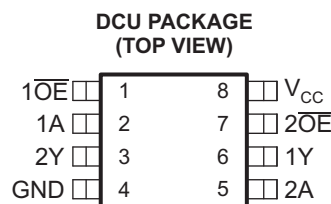
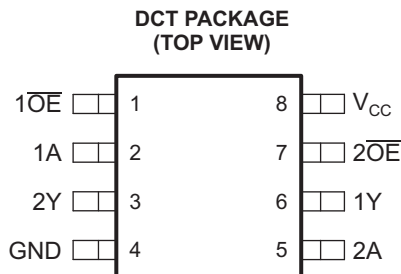

See mechanical drawings for dimensions.



Please be aware that an important notice concerning availability, standard warranty, and use in critical applications of Texas Instruments semiconductor products and disclaimers thereto appears at the end of this data sheet.

NanoFree is a trademark of Texas Instruments.



These devices have limited built-in ESD protection. The leads should be shorted together or the device placed in conductive foam during storage or handling to prevent electrostatic damage to the MOS gates.

**Function Table  
(Each Buffer)**

| INPUTS          |   | OUTPUT |
|-----------------|---|--------|
| $\overline{OE}$ | A | Y      |
| L               | H | L      |
| L               | L | H      |
| H               | X | Z      |

**Logic Diagram (Positive Logic)**

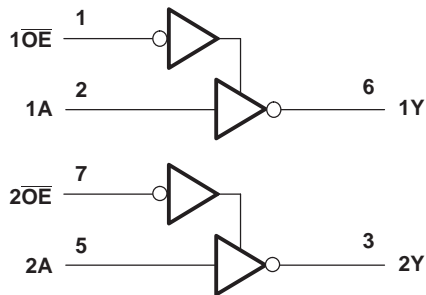

### Absolute Maximum Ratings<sup>(1)</sup>

over operating free-air temperature range (unless otherwise noted)

|               |                                                                                             | MIN         | MAX            | UNIT    |
|---------------|---------------------------------------------------------------------------------------------|-------------|----------------|---------|
| $V_{CC}$      | Supply voltage range                                                                        | -0.5        | 6.5            | V       |
| $V_I$         | Input voltage range <sup>(2)</sup>                                                          | -0.5        | 6.5            | V       |
| $V_O$         | Voltage range applied to any output in the high-impedance or power-off state <sup>(2)</sup> | -0.5        | 6.5            | V       |
| $V_O$         | Voltage range applied to any output in the high or low state <sup>(2)(3)</sup>              | -0.5        | $V_{CC} + 0.5$ | V       |
| $I_{IK}$      | Input clamp current                                                                         | $V_I < 0$   |                | -50 mA  |
| $I_{OK}$      | Output clamp current                                                                        | $V_O < 0$   |                | -50 mA  |
| $I_O$         | Continuous output current                                                                   |             |                | ±50 mA  |
|               | Continuous current through $V_{CC}$ or GND                                                  |             |                | ±100 mA |
| $\theta_{JA}$ | Package thermal impedance <sup>(4)</sup>                                                    | DCT package |                | 220     |
|               |                                                                                             | DCU package |                | 227     |
|               |                                                                                             | YZP package |                | 102     |
| $T_{stg}$     | Storage temperature range                                                                   | -65         | 150            | °C      |

- (1) Stresses beyond those listed under "absolute maximum ratings" may cause permanent damage to the device. These are stress ratings only, and functional operation of the device at these or any other conditions beyond those indicated under "recommended operating conditions" is not implied. Exposure to absolute-maximum-rated conditions for extended periods may affect device reliability.
- (2) The input negative-voltage and output voltage ratings may be exceeded if the input and output current ratings are observed.
- (3) The value of  $V_{CC}$  is provided in the recommended operating conditions table.
- (4) The package thermal impedance is calculated in accordance with JESD 51-7.

**Recommended Operating Conditions<sup>(1)</sup>**

|                 |                                    |                                                 | MIN                    | MAX             | UNIT |
|-----------------|------------------------------------|-------------------------------------------------|------------------------|-----------------|------|
| V <sub>CC</sub> | Supply voltage                     | Operating                                       | 1.65                   | 5.5             | V    |
|                 |                                    | Data retention only                             | 1.5                    |                 |      |
| V <sub>IH</sub> | High-level input voltage           | V <sub>CC</sub> = 1.65 V to 1.95 V              | 0.65 × V <sub>CC</sub> |                 | V    |
|                 |                                    | V <sub>CC</sub> = 2.3 V to 2.7 V                | 1.7                    |                 |      |
|                 |                                    | V <sub>CC</sub> = 3 V to 3.6 V                  | 2                      |                 |      |
|                 |                                    | V <sub>CC</sub> = 4.5 V to 5.5 V                | 0.7 × V <sub>CC</sub>  |                 |      |
| V <sub>IL</sub> | Low-level input voltage            | V <sub>CC</sub> = 1.65 V to 1.95 V              | 0.35 × V <sub>CC</sub> |                 | V    |
|                 |                                    | V <sub>CC</sub> = 2.3 V to 2.7 V                | 0.7                    |                 |      |
|                 |                                    | V <sub>CC</sub> = 3 V to 3.6 V                  | 0.8                    |                 |      |
|                 |                                    | V <sub>CC</sub> = 4.5 V to 5.5 V                | 0.3 × V <sub>CC</sub>  |                 |      |
| V <sub>I</sub>  | Input voltage                      |                                                 | 0                      | 5.5             | V    |
| V <sub>O</sub>  | Output voltage                     | High or low state                               | 0                      | V <sub>CC</sub> | V    |
|                 |                                    | 3-state                                         | 0                      | 5.5             |      |
| I <sub>OH</sub> | High-level output current          | V <sub>CC</sub> = 1.65 V                        | –4                     |                 | mA   |
|                 |                                    | V <sub>CC</sub> = 2.3 V                         | –8                     |                 |      |
|                 |                                    | V <sub>CC</sub> = 3 V                           | –16                    |                 |      |
|                 |                                    | V <sub>CC</sub> = 4.5 V                         | –24                    |                 |      |
| I <sub>OL</sub> | Low-level output current           | V <sub>CC</sub> = 1.65 V                        | 4                      |                 | mA   |
|                 |                                    | V <sub>CC</sub> = 2.3 V                         | 8                      |                 |      |
|                 |                                    | V <sub>CC</sub> = 3 V                           | 16                     |                 |      |
|                 |                                    | V <sub>CC</sub> = 4.5 V                         | 24                     |                 |      |
| Δt/Δv           | Input transition rise or fall rate | V <sub>CC</sub> = 1.8 V ± 0.15 V, 2.5 V ± 0.2 V | 20                     |                 | ns/V |
|                 |                                    | V <sub>CC</sub> = 3.3 V ± 0.3 V                 | 10                     |                 |      |
|                 |                                    | V <sub>CC</sub> = 5 V ± 0.5 V                   | 5                      |                 |      |
| T <sub>A</sub>  | Operating free-air temperature     |                                                 | –40                    | 125             | °C   |

(1) All unused inputs of the device must be held at V<sub>CC</sub> or GND to ensure proper device operation. Refer to the TI application report, *Implications of Slow or Floating CMOS Inputs*, literature number [SCBA004](#).

## Electrical Characteristics

over recommended operating free-air temperature range (unless otherwise noted)

| PARAMETER        | TEST CONDITIONS                                                              | V <sub>CC</sub> | –40°C to 85°C         |                    |     | –40°C to 125°C        |                    |     | UNIT |
|------------------|------------------------------------------------------------------------------|-----------------|-----------------------|--------------------|-----|-----------------------|--------------------|-----|------|
|                  |                                                                              |                 | MIN                   | TYP <sup>(1)</sup> | MAX | MIN                   | TYP <sup>(1)</sup> | MAX |      |
| V <sub>OH</sub>  | I <sub>OH</sub> = –100 μA                                                    | 1.65 V to 5.5 V | V <sub>CC</sub> – 0.1 |                    |     | V <sub>CC</sub> – 0.1 |                    |     | V    |
|                  | I <sub>OH</sub> = –4 mA                                                      | 1.65 V          | 1.2                   |                    |     | 1.2                   |                    |     |      |
|                  | I <sub>OH</sub> = –8 mA                                                      | 2.3 V           | 1.9                   |                    |     | 1.9                   |                    |     |      |
|                  | I <sub>OH</sub> = –16 mA                                                     | 3 V             | 2.4                   |                    |     | 2.4                   |                    |     |      |
|                  | I <sub>OH</sub> = –24 mA                                                     |                 | 2.3                   |                    |     | 2.3                   |                    |     |      |
|                  | I <sub>OH</sub> = –32 mA                                                     | 4.5 V           | 3.8                   |                    |     | 3.8                   |                    |     |      |
| V <sub>OL</sub>  | I <sub>OL</sub> = 100 μA                                                     | 1.65 V to 5.5 V | 0.1                   |                    |     | 0.1                   |                    |     | V    |
|                  | I <sub>OL</sub> = 4 mA                                                       | 1.65 V          | 0.45                  |                    |     | 0.45                  |                    |     |      |
|                  | I <sub>OL</sub> = 8 mA                                                       | 2.3 V           | 0.3                   |                    |     | 0.3                   |                    |     |      |
|                  | I <sub>OL</sub> = 16 mA                                                      | 3 V             | 0.4                   |                    |     | 0.4                   |                    |     |      |
|                  | I <sub>OL</sub> = 24 mA                                                      |                 | 0.55                  |                    |     | 0.55                  |                    |     |      |
|                  | I <sub>OL</sub> = 32 mA                                                      | 4.5 V           | 0.55                  |                    |     | 0.75                  |                    |     |      |
| I <sub>I</sub>   | A or $\overline{OE}$ inputs<br>V <sub>I</sub> = 5.5 V or GND                 | 0 to 5.5 V      | ±5                    |                    |     | ±5                    |                    |     | μA   |
| I <sub>off</sub> | V <sub>I</sub> or V <sub>O</sub> = 5.5 V                                     | 0               | ±10                   |                    |     | ±10                   |                    |     | μA   |
| I <sub>OZ</sub>  | V <sub>O</sub> = 0 to 5.5 V                                                  | 3.6 V           | 10                    |                    |     | 10                    |                    |     | μA   |
| I <sub>CC</sub>  | V <sub>I</sub> = 5.5 V or GND, I <sub>O</sub> = 0                            | 1.65 V to 5.5 V | 10                    |                    |     | 10                    |                    |     | μA   |
| ΔI <sub>CC</sub> | One input at V <sub>CC</sub> – 0.6 V, Other inputs at V <sub>CC</sub> or GND | 3 V to 5.5 V    | 500                   |                    |     | 500                   |                    |     | μA   |
| C <sub>i</sub>   | V <sub>I</sub> = V <sub>CC</sub> or GND                                      | 3.3 V           | 4                     |                    |     |                       |                    |     | pF   |
| C <sub>o</sub>   | V <sub>O</sub> = V <sub>CC</sub> or GND                                      | 3.3 V           | 6                     |                    |     |                       |                    |     | pF   |

(1) All typical values are at V<sub>CC</sub> = 3.3 V, T<sub>A</sub> = 25°C.

## Switching Characteristics

 over recommended operating free-air temperature range (unless otherwise noted) (see [Figure 1](#))

| PARAMETER        | FROM<br>(INPUT)        | TO<br>(OUTPUT) | SN74LVC2G240<br>–40°C to 85°C       |      |                                    |     |                                    |     |                                  |     | UNIT |
|------------------|------------------------|----------------|-------------------------------------|------|------------------------------------|-----|------------------------------------|-----|----------------------------------|-----|------|
|                  |                        |                | V <sub>CC</sub> = 1.8 V<br>± 0.15 V |      | V <sub>CC</sub> = 2.5 V<br>± 0.2 V |     | V <sub>CC</sub> = 3.3 V<br>± 0.3 V |     | V <sub>CC</sub> = 5 V<br>± 0.5 V |     |      |
|                  |                        |                | MIN                                 | MAX  | MIN                                | MAX | MIN                                | MAX | MIN                              | MAX |      |
| t <sub>pd</sub>  | A                      | Y              | 2.0                                 | 11.3 | 1.4                                | 5.5 | 1.1                                | 4.6 | 1.0                              | 4.0 | ns   |
| t <sub>en</sub>  | $\overline{\text{OE}}$ | Y              | 2.7                                 | 11.7 | 1.9                                | 6.6 | 1.4                                | 5.4 | 1.1                              | 5.0 | ns   |
| t <sub>dis</sub> | $\overline{\text{OE}}$ | Y              | 1.7                                 | 12.8 | 0.8                                | 5.7 | 1.2                                | 5.5 | 0.5                              | 4.2 | ns   |

## Switching Characteristics

 over recommended operating free-air temperature range (unless otherwise noted) (see [Figure 1](#))

| PARAMETER        | FROM<br>(INPUT)        | TO<br>(OUTPUT) | SN74LVC2G240<br>–40°C to 85°C       |      |                                    |     |                                    |     |                                  |     | UNIT |
|------------------|------------------------|----------------|-------------------------------------|------|------------------------------------|-----|------------------------------------|-----|----------------------------------|-----|------|
|                  |                        |                | V <sub>CC</sub> = 1.8 V<br>± 0.15 V |      | V <sub>CC</sub> = 2.5 V<br>± 0.2 V |     | V <sub>CC</sub> = 3.3 V<br>± 0.3 V |     | V <sub>CC</sub> = 5 V<br>± 0.5 V |     |      |
|                  |                        |                | MIN                                 | MAX  | MIN                                | MAX | MIN                                | MAX | MIN                              | MAX |      |
| t <sub>pd</sub>  | A                      | Y              | 2.0                                 | 13.7 | 1.4                                | 6.8 | 1.1                                | 5.8 | 1.0                              | 5.0 | ns   |
| t <sub>en</sub>  | $\overline{\text{OE}}$ | Y              | 2.7                                 | 14.3 | 1.9                                | 8.0 | 1.4                                | 6.6 | 1.1                              | 6.0 | ns   |
| t <sub>dis</sub> | $\overline{\text{OE}}$ | Y              | 1.7                                 | 15.3 | 0.8                                | 7.5 | 1.2                                | 6.8 | 0.5                              | 5.4 | ns   |

## Operating Characteristics

 T<sub>A</sub> = 25°C

| PARAMETER       |                                                 | TEST<br>CONDITIONS                  | V <sub>CC</sub> = 1.8 V | V <sub>CC</sub> = 2.5 V | V <sub>CC</sub> = 3.3 V | V <sub>CC</sub> = 5 V | UNIT |    |
|-----------------|-------------------------------------------------|-------------------------------------|-------------------------|-------------------------|-------------------------|-----------------------|------|----|
|                 |                                                 |                                     | TYP                     | TYP                     | TYP                     | TYP                   |      |    |
| C <sub>pd</sub> | Power dissipation capacitance per buffer driver | Outputs enabled<br>Outputs disabled | f = 10 MHz              |                         |                         | 15                    | 17   | pF |
|                 |                                                 |                                     |                         | 1                       | 1                       | 2                     | 3    |    |

Parameter Measurement Information

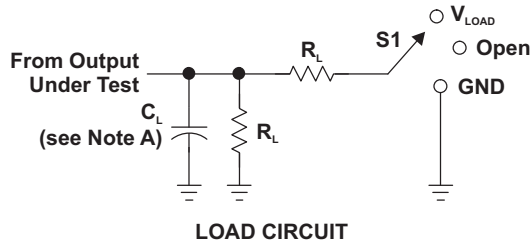

| TEST              | S1         |
|-------------------|------------|
| $t_{PLH}/t_{PHL}$ | Open       |
| $t_{PLZ}/t_{PZL}$ | $V_{LOAD}$ |
| $t_{PHZ}/t_{PZH}$ | GND        |

LOAD CIRCUIT

| $V_{CC}$                         | INPUTS   |                      | $V_M$      | $V_{LOAD}$        | $C_L$ | $R_L$        | $V_{\Delta}$ |
|----------------------------------|----------|----------------------|------------|-------------------|-------|--------------|--------------|
|                                  | $V_I$    | $t_i/t_r$            |            |                   |       |              |              |
| $1.8\text{ V} \pm 0.15\text{ V}$ | $V_{CC}$ | $\leq 2\text{ ns}$   | $V_{CC}/2$ | $2 \times V_{CC}$ | 30 pF | 1 k $\Omega$ | 0.15 V       |
| $2.5\text{ V} \pm 0.2\text{ V}$  | $V_{CC}$ | $\leq 2\text{ ns}$   | $V_{CC}/2$ | $2 \times V_{CC}$ | 30 pF | 500 $\Omega$ | 0.15 V       |
| $3.3\text{ V} \pm 0.3\text{ V}$  | 3 V      | $\leq 2.5\text{ ns}$ | 1.5 V      | 6 V               | 50 pF | 500 $\Omega$ | 0.3 V        |
| $5\text{ V} \pm 0.5\text{ V}$    | $V_{CC}$ | $\leq 2.5\text{ ns}$ | $V_{CC}/2$ | $2 \times V_{CC}$ | 50 pF | 500 $\Omega$ | 0.3 V        |

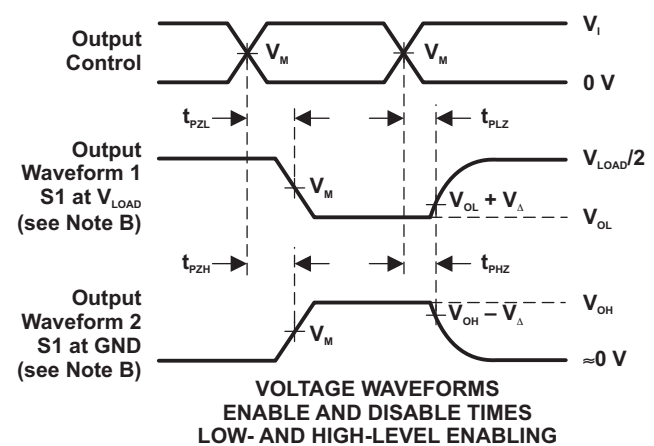
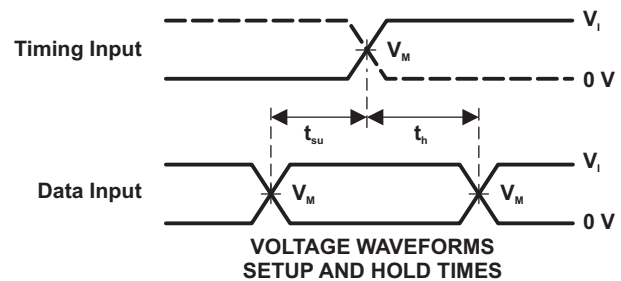

- NOTES: A.  $C_L$  includes probe and jig capacitance.  
 B. Waveform 1 is for an output with internal conditions such that the output is low, except when disabled by the output control. Waveform 2 is for an output with internal conditions such that the output is high, except when disabled by the output control.  
 C. All input pulses are supplied by generators having the following characteristics: PRR  $\leq$  10 MHz,  $Z_o = 50\ \Omega$ .  
 D. The outputs are measured one at a time, with one transition per measurement.  
 E.  $t_{PLZ}$  and  $t_{PHZ}$  are the same as  $t_{dis}$ .  
 F.  $t_{PZL}$  and  $t_{PZH}$  are the same as  $t_{en}$ .  
 G.  $t_{PLH}$  and  $t_{PHL}$  are the same as  $t_{pd}$ .  
 H. All parameters and waveforms are not applicable to all devices.

Figure 1. Load Circuit and Voltage Waveforms

## REVISION HISTORY

| Changes from Revision H (February 2007) to Revision I | Page |
|-------------------------------------------------------|------|
| • Updated document to new TI data sheet format. ....  | 1    |
| • Removed ordering information. ....                  | 1    |
| • Updated Features. ....                              | 1    |
| • Added ESD warning. ....                             | 2    |
| • Updated operating temperature range. ....           | 3    |

**PACKAGING INFORMATION**

| Orderable Device | Status<br>(1) | Package Type | Package Drawing | Pins | Package Qty | Eco Plan<br>(2) | Lead finish/<br>Ball material<br>(6) | MSL Peak Temp<br>(3) | Op Temp (°C) | Device Marking<br>(4/5) | Samples                 |
|------------------|---------------|--------------|-----------------|------|-------------|-----------------|--------------------------------------|----------------------|--------------|-------------------------|-------------------------|
| 74LVC2G240DCURG4 | ACTIVE        | VSSOP        | DCU             | 8    | 3000        | RoHS & Green    | NIPDAU                               | Level-1-260C-UNLIM   | -40 to 125   | C40R                    | <a href="#">Samples</a> |
| SN74LVC2G240DCTR | ACTIVE        | SM8          | DCT             | 8    | 3000        | RoHS & Green    | NIPDAU                               | Level-1-260C-UNLIM   | -40 to 125   | C40<br>(R, Z)           | <a href="#">Samples</a> |
| SN74LVC2G240DCUR | ACTIVE        | VSSOP        | DCU             | 8    | 3000        | RoHS & Green    | NIPDAU   SN                          | Level-1-260C-UNLIM   | -40 to 125   | (C40J, C40Q, C40R)      | <a href="#">Samples</a> |
| SN74LVC2G240YZPR | ACTIVE        | DSBGA        | YZP             | 8    | 3000        | RoHS & Green    | SNAGCU                               | Level-1-260C-UNLIM   | -40 to 125   | (CK7, CKN)              | <a href="#">Samples</a> |

(1) The marketing status values are defined as follows:

**ACTIVE:** Product device recommended for new designs.

**LIFEBUY:** TI has announced that the device will be discontinued, and a lifetime-buy period is in effect.

**NRND:** Not recommended for new designs. Device is in production to support existing customers, but TI does not recommend using this part in a new design.

**PREVIEW:** Device has been announced but is not in production. Samples may or may not be available.

**OBSELETE:** TI has discontinued the production of the device.

(2) **RoHS:** TI defines "RoHS" to mean semiconductor products that are compliant with the current EU RoHS requirements for all 10 RoHS substances, including the requirement that RoHS substance do not exceed 0.1% by weight in homogeneous materials. Where designed to be soldered at high temperatures, "RoHS" products are suitable for use in specified lead-free processes. TI may reference these types of products as "Pb-Free".

**RoHS Exempt:** TI defines "RoHS Exempt" to mean products that contain lead but are compliant with EU RoHS pursuant to a specific EU RoHS exemption.

**Green:** TI defines "Green" to mean the content of Chlorine (Cl) and Bromine (Br) based flame retardants meet JS709B low halogen requirements of <=1000ppm threshold. Antimony trioxide based flame retardants must also meet the <=1000ppm threshold requirement.

(3) MSL, Peak Temp. - The Moisture Sensitivity Level rating according to the JEDEC industry standard classifications, and peak solder temperature.

(4) There may be additional marking, which relates to the logo, the lot trace code information, or the environmental category on the device.

(5) Multiple Device Markings will be inside parentheses. Only one Device Marking contained in parentheses and separated by a "~" will appear on a device. If a line is indented then it is a continuation of the previous line and the two combined represent the entire Device Marking for that device.

(6) Lead finish/Ball material - Orderable Devices may have multiple material finish options. Finish options are separated by a vertical ruled line. Lead finish/Ball material values may wrap to two lines if the finish value exceeds the maximum column width.

**Important Information and Disclaimer:**The information provided on this page represents TI's knowledge and belief as of the date that it is provided. TI bases its knowledge and belief on information provided by third parties, and makes no representation or warranty as to the accuracy of such information. Efforts are underway to better integrate information from third parties. TI has taken and



continues to take reasonable steps to provide representative and accurate information but may not have conducted destructive testing or chemical analysis on incoming materials and chemicals. TI and TI suppliers consider certain information to be proprietary, and thus CAS numbers and other limited information may not be available for release.

In no event shall TI's liability arising out of such information exceed the total purchase price of the TI part(s) at issue in this document sold by TI to Customer on an annual basis.

## TAPE AND REEL INFORMATION

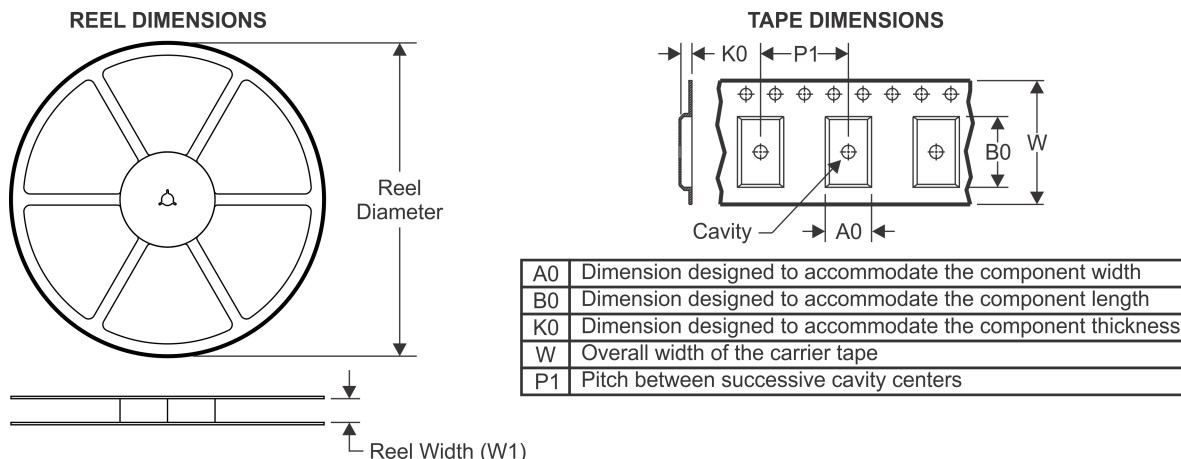

### QUADRANT ASSIGNMENTS FOR PIN 1 ORIENTATION IN TAPE



\*All dimensions are nominal

| Device           | Package Type | Package Drawing | Pins | SPQ  | Reel Diameter (mm) | Reel Width W1 (mm) | A0 (mm) | B0 (mm) | K0 (mm) | P1 (mm) | W (mm) | Pin1 Quadrant |
|------------------|--------------|-----------------|------|------|--------------------|--------------------|---------|---------|---------|---------|--------|---------------|
| 74LVC2G240DCURG4 | VSSOP        | DCU             | 8    | 3000 | 180.0              | 8.4                | 2.25    | 3.35    | 1.05    | 4.0     | 8.0    | Q3            |
| SN74LVC2G240DCTR | SM8          | DCT             | 8    | 3000 | 177.8              | 12.4               | 3.45    | 4.4     | 1.45    | 4.0     | 12.0   | Q3            |
| SN74LVC2G240DCTR | SM8          | DCT             | 8    | 3000 | 180.0              | 13.0               | 3.35    | 4.5     | 1.55    | 4.0     | 12.0   | Q3            |
| SN74LVC2G240DCUR | VSSOP        | DCU             | 8    | 3000 | 180.0              | 8.4                | 2.25    | 3.35    | 1.05    | 4.0     | 8.0    | Q3            |
| SN74LVC2G240DCUR | VSSOP        | DCU             | 8    | 3000 | 178.0              | 9.0                | 2.25    | 3.35    | 1.05    | 4.0     | 8.0    | Q3            |
| SN74LVC2G240DCUR | VSSOP        | DCU             | 8    | 3000 | 178.0              | 9.5                | 2.25    | 3.35    | 1.05    | 4.0     | 8.0    | Q3            |
| SN74LVC2G240YZPR | DSBGA        | YZP             | 8    | 3000 | 178.0              | 9.2                | 1.02    | 2.02    | 0.63    | 4.0     | 8.0    | Q1            |

**TAPE AND REEL BOX DIMENSIONS**

\*All dimensions are nominal

| Device           | Package Type | Package Drawing | Pins | SPQ  | Length (mm) | Width (mm) | Height (mm) |
|------------------|--------------|-----------------|------|------|-------------|------------|-------------|
| 74LVC2G240DCURG4 | VSSOP        | DCU             | 8    | 3000 | 202.0       | 201.0      | 28.0        |
| SN74LVC2G240DCTR | SM8          | DCT             | 8    | 3000 | 183.0       | 183.0      | 20.0        |
| SN74LVC2G240DCTR | SM8          | DCT             | 8    | 3000 | 182.0       | 182.0      | 20.0        |
| SN74LVC2G240DCUR | VSSOP        | DCU             | 8    | 3000 | 202.0       | 201.0      | 28.0        |
| SN74LVC2G240DCUR | VSSOP        | DCU             | 8    | 3000 | 180.0       | 180.0      | 18.0        |
| SN74LVC2G240DCUR | VSSOP        | DCU             | 8    | 3000 | 202.0       | 201.0      | 28.0        |
| SN74LVC2G240YZPR | DSBGA        | YZP             | 8    | 3000 | 220.0       | 220.0      | 35.0        |

YZP0008



PACKAGE OUTLINE

DSBGA - 0.5 mm max height

DIE SIZE BALL GRID ARRAY

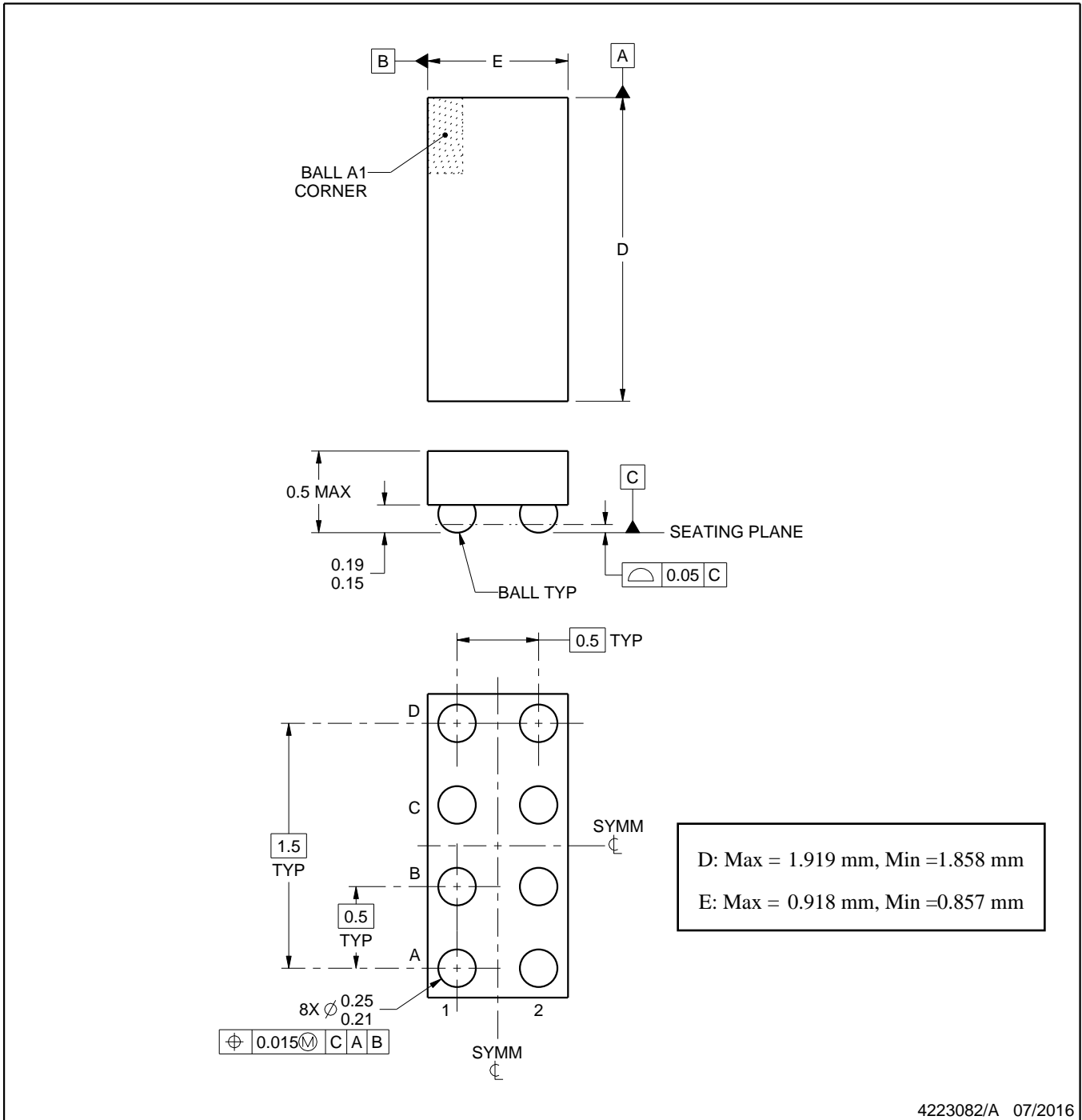

NOTES:

1. All linear dimensions are in millimeters. Any dimensions in parenthesis are for reference only. Dimensioning and tolerancing per ASME Y14.5M.
2. This drawing is subject to change without notice.

# EXAMPLE BOARD LAYOUT

YZP0008

DSBGA - 0.5 mm max height

DIE SIZE BALL GRID ARRAY



LAND PATTERN EXAMPLE  
SCALE:40X



SOLDER MASK DETAILS  
NOT TO SCALE

4223082/A 07/2016

NOTES: (continued)

3. Final dimensions may vary due to manufacturing tolerance considerations and also routing constraints. For more information, see Texas Instruments literature number SNVA009 ([www.ti.com/lit/snva009](http://www.ti.com/lit/snva009)).

# EXAMPLE STENCIL DESIGN

YZP0008

DSBGA - 0.5 mm max height

DIE SIZE BALL GRID ARRAY



SOLDER PASTE EXAMPLE  
BASED ON 0.1 mm THICK STENCIL  
SCALE:40X

4223082/A 07/2016

NOTES: (continued)

4. Laser cutting apertures with trapezoidal walls and rounded corners may offer better paste release.

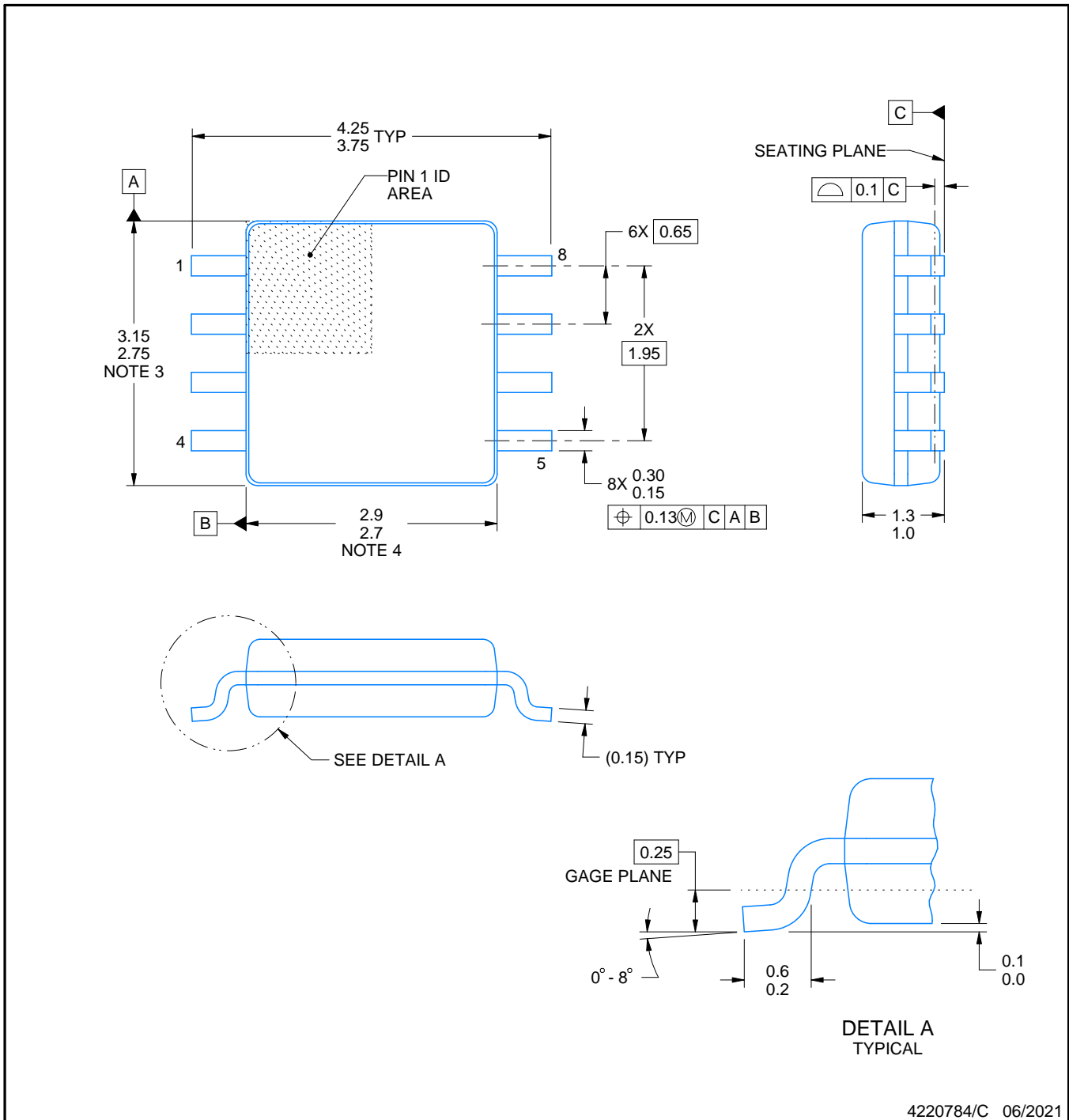
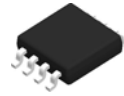

4220784/C 06/2021

NOTES:

1. All linear dimensions are in millimeters. Dimensions in parenthesis are for reference only. Dimensioning and tolerancing per ASME Y14.5M.
2. This drawing is subject to change without notice.
3. This dimension does not include mold flash, protrusions, or gate burrs. Mold flash, protrusions, or gate burrs shall not exceed 0.15 mm per side.
4. This dimension does not include interlead flash. Interlead flash shall not exceed 0.25 mm per side.

# EXAMPLE BOARD LAYOUT

DCT0008A

SSOP - 1.3 mm max height

SMALL OUTLINE PACKAGE

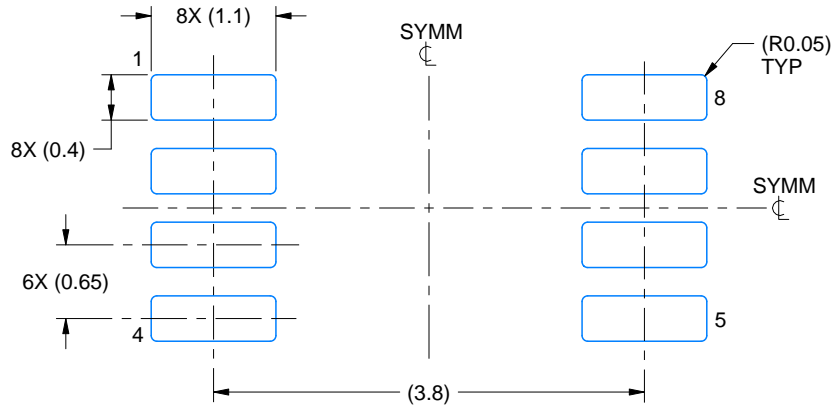

LAND PATTERN EXAMPLE  
EXPOSED METAL SHOWN  
SCALE:15X

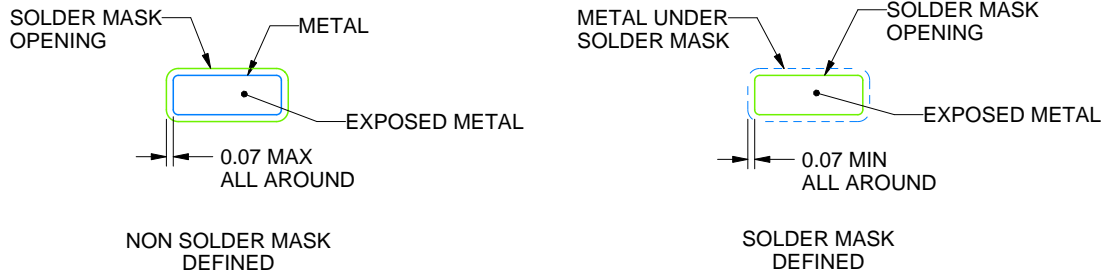

SOLDER MASK DETAILS

4220784/C 06/2021

NOTES: (continued)

5. Publication IPC-7351 may have alternate designs.
6. Solder mask tolerances between and around signal pads can vary based on board fabrication site.



# EXAMPLE STENCIL DESIGN

DCT0008A

SSOP - 1.3 mm max height

SMALL OUTLINE PACKAGE

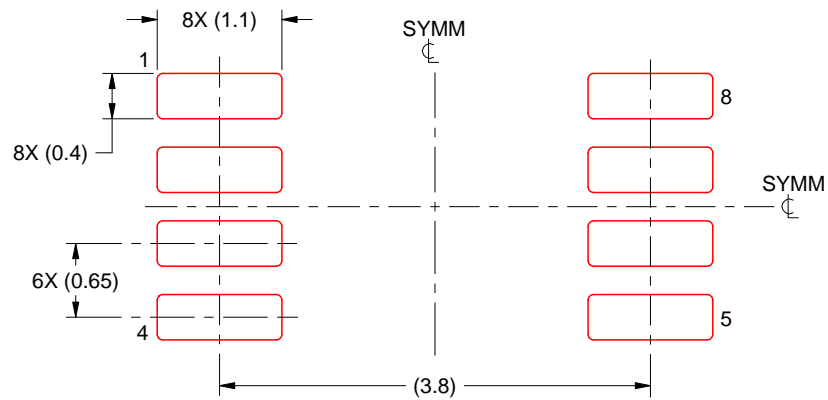

SOLDER PASTE EXAMPLE  
BASED ON 0.125 mm THICK STENCIL  
SCALE:15X

4220784/C 06/2021

NOTES: (continued)

7. Laser cutting apertures with trapezoidal walls and rounded corners may offer better paste release. IPC-7525 may have alternate design recommendations.
8. Board assembly site may have different recommendations for stencil design.

# MECHANICAL DATA

DCU (R-PDSO-G8)

PLASTIC SMALL-OUTLINE PACKAGE (DIE DOWN)

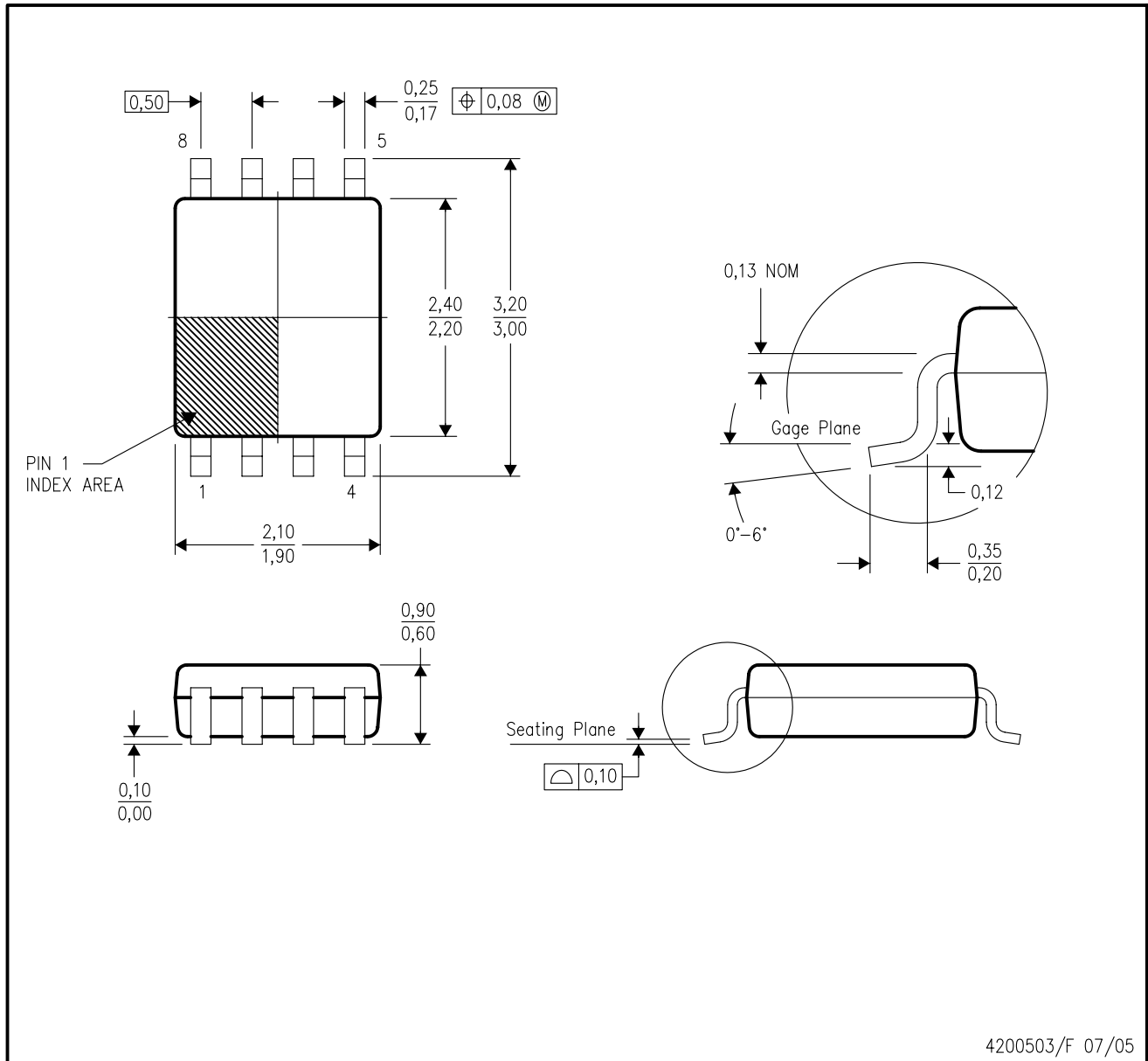

- NOTES:
- A. All linear dimensions are in millimeters.
  - B. This drawing is subject to change without notice.
  - C. Body dimensions do not include mold flash or protrusion. Mold flash and protrusion shall not exceed 0.15 per side.
  - D. Falls within JEDEC MO-187 variation CA.

DCU (S-PDSO-G8)

PLASTIC SMALL OUTLINE PACKAGE (DIE DOWN)



- NOTES:
- A. All linear dimensions are in millimeters.
  - B. This drawing is subject to change without notice.
  - C. Publication IPC-7351 is recommended for alternate designs.
  - D. Laser cutting apertures with trapezoidal walls and also rounding corners will offer better paste release. Customers should contact their board assembly site for stencil design recommendations. Refer to IPC-7525 for other stencil recommendations.
  - E. Customers should contact their board fabrication site for solder mask tolerances between and around signal pads.

## IMPORTANT NOTICE AND DISCLAIMER

TI PROVIDES TECHNICAL AND RELIABILITY DATA (INCLUDING DATASHEETS), DESIGN RESOURCES (INCLUDING REFERENCE DESIGNS), APPLICATION OR OTHER DESIGN ADVICE, WEB TOOLS, SAFETY INFORMATION, AND OTHER RESOURCES "AS IS" AND WITH ALL FAULTS, AND DISCLAIMS ALL WARRANTIES, EXPRESS AND IMPLIED, INCLUDING WITHOUT LIMITATION ANY IMPLIED WARRANTIES OF MERCHANTABILITY, FITNESS FOR A PARTICULAR PURPOSE OR NON-INFRINGEMENT OF THIRD PARTY INTELLECTUAL PROPERTY RIGHTS.

These resources are intended for skilled developers designing with TI products. You are solely responsible for (1) selecting the appropriate TI products for your application, (2) designing, validating and testing your application, and (3) ensuring your application meets applicable standards, and any other safety, security, or other requirements. These resources are subject to change without notice. TI grants you permission to use these resources only for development of an application that uses the TI products described in the resource. Other reproduction and display of these resources is prohibited. No license is granted to any other TI intellectual property right or to any third party intellectual property right. TI disclaims responsibility for, and you will fully indemnify TI and its representatives against, any claims, damages, costs, losses, and liabilities arising out of your use of these resources.

TI's products are provided subject to TI's Terms of Sale (<https://www.ti.com/legal/termsofsale.html>) or other applicable terms available either on [ti.com](https://www.ti.com) or provided in conjunction with such TI products. TI's provision of these resources does not expand or otherwise alter TI's applicable warranties or warranty disclaimers for TI products.

Mailing Address: Texas Instruments, Post Office Box 655303, Dallas, Texas 75265  
Copyright © 2021, Texas Instruments Incorporated