

Ultra-wide bandwidth, low-noise, 3-axis digital vibration sensor

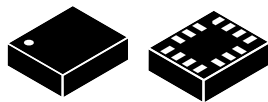

LGA-14L
(2.5 x 3.0 x 0.83 mm) typ.

Features

- 3-axis vibration sensor with digital output
- User-selectable full-scale: $\pm 2/\pm 4/\pm 8/\pm 16$ g
- Ultra-wide and flat frequency response range: from dc to 6 kHz (± 3 dB point)
- Ultra-low noise density: down to $75 \mu\text{g}/\sqrt{\text{Hz}}$ in 3-axis mode / $60 \mu\text{g}/\sqrt{\text{Hz}}$ in single-axis mode
- High stability of the sensitivity over temperature and against mechanical shocks
- Extended temperature range from -40 to $+105$ °C
- Low power: 1.1 mA with all 3 axes delivering full performance
- SPI serial interface
- Low-pass or high-pass filter with selectable cut-off frequency
- Interrupts for wake-up / activity - inactivity / FIFO thresholds
- Embedded FIFO: 3 kB
- Embedded temperature sensor
- Embedded self-test
- Supply voltage: 2.1 V to 3.6 V
- Compact package: LGA 2.5 x 3 x 0.83 mm 14-lead
- ECOPACK, RoHS and “Green” compliant

Applications



- Vibration monitoring
- Condition monitoring
- Predictive maintenance
- Test and measurements

Description

The IIS3DWB is a system-in-package featuring a 3-axis digital vibration sensor with low noise over an ultra-wide and flat frequency range. The wide bandwidth, low noise, very stable and repeatable sensitivity, together with the capability of operating over an extended temperature range (up to $+105$ °C), make the device particularly suitable for vibration monitoring in industrial applications.

The high performance delivered at low power consumption together with the digital output and the embedded digital features like the FIFO and the interrupts are enabling features for battery-operated industrial wireless sensor nodes.

The IIS3DWB has a selectable full-scale acceleration range of $\pm 2/\pm 4/\pm 8/\pm 16$ g and is capable of measuring accelerations with a bandwidth up to 6 kHz with an output data rate of 26.7 kHz. A 3 kB first-in, first-out (FIFO) buffer is integrated in the device to avoid any data loss and to limit intervention of the host processor.

Product status link		
IIS3DWB		
Product summary		
Order code	IIS3DWBTR	IIS3DWB
Temp. range [°C]	-40 to +105	
Package	LGA-14	
Packing	Tape and reel	Tray
Product labels		
 		

The MEMS sensor module family from ST leverages the robust and mature manufacturing processes already used for the production of micromachined accelerometers and gyroscopes to serve automotive, industrial and consumer markets. The sensing elements are manufactured using ST's proprietary micromachining process, while the embedded IC interfaces are developed using CMOS technology.

The IIS3DWB has a self-test capability which allows checking the functioning of the sensor in the final application. The IIS3DWB is available in a 14-lead plastic land grid array (LGA) package and is guaranteed to operate over an extended temperature range from -40 °C to +105 °C.

1 Pin description

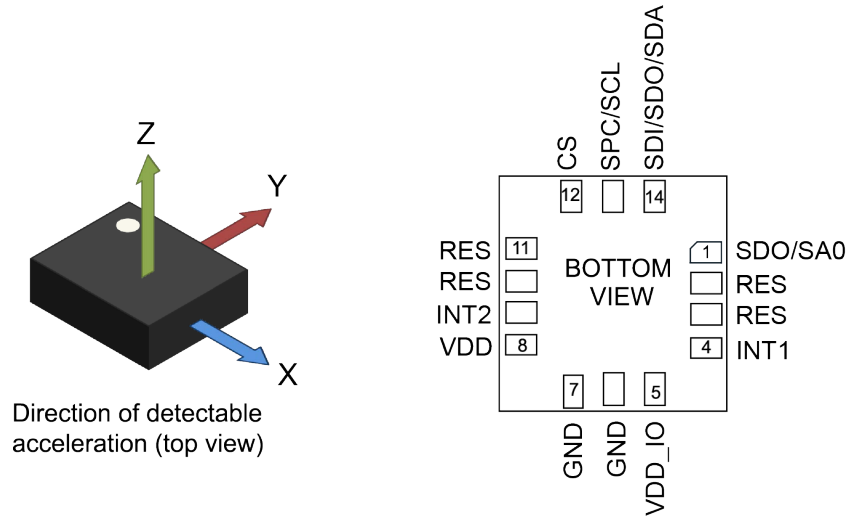
Figure 1. Pin connections

Table 1. Pin description

Pin #	Name	Function
1	SDO/SA0	SPI 4-wire interface serial data output (SDO) I ² C ⁽¹⁾ least significant bit of the device address (SA0)
2	RES	Connect to VDD_IO or GND
3	RES	Connect to VDD_IO or GND
4	INT1	Programmable interrupt #1
5	VDD_IO ⁽²⁾	Power supply for I/O pins
6	GND	Connect to GND
7	GND	Connect to GND
8	VDD ⁽²⁾	Power supply
9	INT2	Programmable interrupt #2
10	RES	Connect to VDD_IO or leave unconnected ⁽³⁾
11	RES	Connect to VDD_IO or leave unconnected ⁽³⁾
12	CS	I ² C/SPI ⁽⁴⁾ mode selection (1: SPI idle mode / I ² C ⁽¹⁾ communication enabled; 0: SPI communication mode / I ² C ⁽¹⁾ disabled)
13	SPC/SCL	SPI serial port clock (SPC) I ² C serial clock (SCL)
14	SDI/SDO/SDA	SPI serial data input (SDI) 3-wire interface serial data output (SDO) I ² C serial data (SDA)

1. Only the SPI interface supports all the device features and capabilities. Due to limited throughput, the I²C interface can be used only in single-axis mode and it is not recommended.
2. Recommended 100 nF filter capacitor.
3. Leave pin electrically unconnected and soldered to PCB.

1.1 Default pin configuration

The IIS3DWB default pin configuration and behavior is given in the table below.

Table 2. Default pin status

Pin#	Name	Function	Default status	Recommended connection
1	SDO/SA0	SPI 4-wire interface serial data output (SDO) I ² C least significant bit of the device address (SA0)	Input without pull-up Pull-up is enabled if bit SDO_PU_EN=1 in reg 02h	Application specific
2	RES	Reserved	Input without pull-up	Connect to VDD_IO or GND
3	RES	Reserved	Input without pull-up	Connect to VDD_IO or GND
4	INT1	Programmable interrupt #1	Input with pull-down	Must be set to 0 or left unconnected during device power-up. After device power-up, connection is application specific.
5	VDD_IO	Power supply for I/O pin	-	
6	GND	Ground	-	
7	GND	Ground	-	
8	VDD	Power supply	-	
9	INT2	Programmable interrupt #2	Output forced to GND	Application specific
10	RES	Reserved	Input with pull-up	Connect to VDD_IO or leave pin electrically unconnected and soldered to PCB
11	RES	Reserved	Input with pull-up	Connect to VDD_IO or leave pin electrically unconnected and soldered to PCB
12	CS	I ² C/SPI mode selection (1: SPI idle mode / I ² C communication enabled; 0: SPI communication mode / I ² C disabled)	Input with pull-up Pull-up is disabled if bit I2C_DISABLE=1 in reg 13h	Application specific
13	SPC/SCL	SPI serial port clock (SPC) I ² C serial clock (SCL)	Input without pull-up	Application specific
14	SDI/SDO/SDA	SPI serial data input (SDI) 3-wire interface serial data output (SDO) I ² C serial data (SDA)	Input without pull-up	Application specific

2 Module specifications

2.1 Mechanical characteristics

@Vdd = 3.0 V, T = +25 °C unless otherwise noted.

The product is factory calibrated at 3.0 V. The operational power supply range is from 2.1 V to 3.6 V.

Table 3. Mechanical characteristics

Symbol	Parameter	Test conditions	Min. ⁽¹⁾	Typ. ⁽²⁾	Max. ⁽¹⁾	Unit	
FS	Linear acceleration measurement range			±2		g	
				±4			
				±8			
				±16			
So	Linear acceleration sensitivity ⁽³⁾	@FS = ±2 g	-2%	0.061	+2%	mg/LSB	
				@FS = ±4 g			0.122
				@FS = ±8 g			0.244
				@FS = ±16 g			0.488
SoDr	Linear acceleration sensitivity change vs. temperature ⁽⁴⁾	from -40°C to +105°C delta from T = +25°C		±1	±2	%	
TyOff	Linear acceleration zero-g level offset accuracy ⁽⁵⁾	T = 25 °C	-180	±60	+180	mg	
TCOff	Linear acceleration zero-g level change vs. temperature ⁽⁴⁾			±1		mg/°C	
An	Acceleration noise density 3 axes enabled ⁽⁶⁾	X-axis		75	110	µg/√Hz	
		Y-axis		75	110		
		Z-axis		110	190		
	Acceleration noise density only 1 axis enabled ⁽⁶⁾	X-axis		60	90		
		Y-axis		60	90		
		Z-axis		80	130		
BW	Signal bandwidth	±3 dB point	5	6.3		kHz	
ODR	Linear acceleration output data rate			26.667		kHz	
ODR_ACC	ODR accuracy	Error wrt 26667 Hz @Vdd 3.0 V, T = +25°C		±1	±2	%	
ODR_TC	ODR change vs. temperature	Error wrt 26667 Hz @Vdd 3.0 V, from -40°C to +105°C delta from T = +25°C			±0.03	%/°C	
F0	Sensor resonant frequency	X-axis		6.9		kHz	
		Y-axis		6.9			
		Z-axis		7.0			
Vst	Linear acceleration self-test output change ⁽⁷⁾⁽⁸⁾⁽⁹⁾	FS = ±4 g	800		3200	mg	
Top	Operating temperature range		-40		+105	°C	

1. Min/Max values are based on characterization results at 3σ on a limited number of samples, not tested in production and not guaranteed.
2. Typical specifications are not guaranteed.
3. Sensitivity values after factory calibration test and trimming.
4. Measurements are performed in a uniform temperature setup and they are based on characterization data in a limited number of samples. Not measured in production and not guaranteed.
5. Values after factory calibration test and trimming.
6. Frequency range 100 Hz - 6.3 kHz. Noise density is independent of the FS selected.
7. The sign of the linear acceleration self-test output change is defined by the STx_XL bits in a dedicated register for all axes.
8. The linear acceleration self-test output change is defined with the device in stationary condition as the absolute value of: OUTPUT[LSb] (self-test enabled) - OUTPUT[LSb] (self-test disabled). 1LSb = 0.122 mg at ± 4 g full scale.
9. Accelerometer self-test limits are full-scale independent. The self-test should be executed with FS setting ≥ 4 g.

2.2 Electrical characteristics

@ Vdd = 3.0 V, T = 25 °C unless otherwise noted.

Table 4. Electrical characteristics

Symbol	Parameter	Test conditions	Min. ⁽¹⁾	Typ. ⁽²⁾	Max. ⁽¹⁾	Unit
Vdd	Supply voltage		2.1		3.6	V
Vdd_IO	Power supply for I/O		1.62		Vdd + 0.1	V
Idd	Accelerometer current consumption	ODR = 26.667 kHz		1.1	1.3	mA
IddPD	Accelerometer current consumption during power-down			5	16	μ A
Ton	Turn-on time ⁽³⁾			10		ms
V _{IH} ⁽⁴⁾	Digital high-level input voltage		0.7 *VDD_IO			V
V _{IL} ⁽⁴⁾	Digital low-level input voltage				0.3 *VDD_IO	V
V _{OH} ⁽⁴⁾	High-level output voltage	I _{OH} = 4 mA ⁽⁵⁾	VDD_IO - 0.2			V
V _{OL} ⁽⁴⁾	Low-level output voltage	I _{OL} = 4 mA ⁽⁵⁾			0.2	V
Top	Operating temperature range		-40		+105 ⁽⁶⁾	°C

1. Min/Max values are based on characterization results at 3σ , not tested in production and not guaranteed.
2. Typical specifications are not guaranteed.
3. Time to obtain valid data switching from power-down to normal operation.
4. Guaranteed by design characterization and not tested in production.
5. 4 mA is the maximum driving capability, i.e. the maximum DC current that can be sourced/sunk by the digital pad in order to guarantee the correct digital output voltage levels V_{OH} and V_{OL}.
6. The IIS3DWB has been qualified with HTOL@125°C for 1000h. In case, in the application, the IIS3DWB has to be operated frequently at high temperature (>50°C), it is recommended, in order to maximize its lifetime, to switch off the sensor, by setting its power supplies to 0 V, when the sensor is not needed to perform measurements. The lower the duty cycle of the IIS3DWB in powered condition, the longer the lifetime of the device which can be extrapolated based on the results of reliability trials.

2.3 Temperature sensor characteristics

@ V_{dd} = 3.0 V, T = 25 °C unless otherwise noted.
The product is factory calibrated at 3.0 V.

Symbol	Parameter	Test condition	Min. ⁽¹⁾	Typ. ⁽²⁾	Max. ⁽¹⁾	Unit
TODR	Temperature refresh rate			104		Hz
Toff	Temperature offset ⁽³⁾		-15		+15	°C
TSen	Temperature sensitivity			256		LSB/°C
T_delta_Acc	Delta temperature accuracy ⁽⁴⁾	from 25°C to 105°C			4	°C
TST	Temperature stabilization time ⁽⁵⁾			10		ms
T_ADC_res	Temperature ADC resolution			16		bit
Top	Operating temperature range		-40		+105	°C

1. Min/Max values are based on characterization results at 3 σ on a limited number of samples, not tested in production and not guaranteed.
2. Typical specifications are not guaranteed.
3. The output of the temperature sensor is 0 LSB (typ.) at 25 °C. Absolute temperature accuracy can be improved (reducing the effect of temperature offset) by performing OPC (one-point calibration) at room temperature (25 °C).
4. Applicable if temperature offset is removed with OPC (one-point calibration) at room temperature (25 °C).
5. Time from power ON to valid output data.

2.4 Communication interface characteristics

2.4.1 SPI - serial peripheral interface

Subject to general operating conditions for Vdd and Top.

Table 5. SPI slave timing values

Symbol	Parameter	Value ⁽¹⁾		Unit
		Min	Max	
$t_{c(SPC)}$	SPI clock cycle	100		ns
$f_{c(SPC)}$	SPI clock frequency		10	MHz
$t_{su(CS)}$	CS setup time	5		ns
$t_{h(CS)}$	CS hold time	20		
$t_{su(SI)}$	SDI input setup time	5		
$t_{h(SI)}$	SDI input hold time	15		
$t_{v(SO)}$	SDO valid output time		50	
$t_{h(SO)}$	SDO output hold time	5		
$t_{dis(SO)}$	SDO output disable time		50	

1. Values are guaranteed at 10 MHz clock frequency for SPI with both 4 and 3 wires, based on characterization results, not tested in production.

Figure 2. SPI slave timing diagram

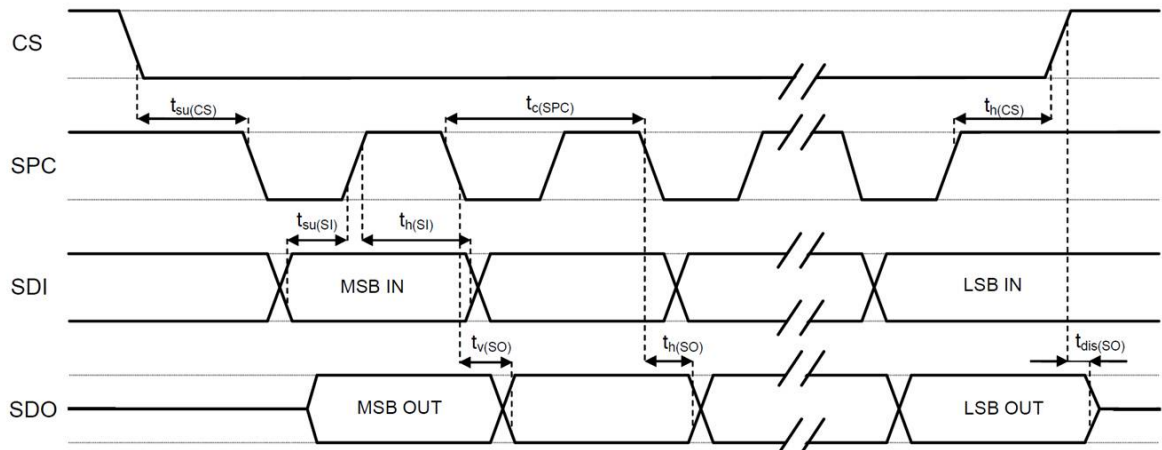

Note: Measurement points are done at $0.2 \cdot V_{dd_IO}$ and $0.8 \cdot V_{dd_IO}$, for both input and output ports.

2.5 Absolute maximum ratings

Stresses above those listed as “Absolute maximum ratings” may cause permanent damage to the device. This is a stress rating only and functional operation of the device under these conditions is not implied. Exposure to maximum rating conditions for extended periods may affect device reliability.

Table 6. Absolute maximum ratings

Symbol	Ratings	Maximum value	Unit
Vdd	Supply voltage	-0.3 to 4.8	V
T _{STG}	Storage temperature range	-40 to +125	°C
Sg	Acceleration <i>g</i> for 0.2 ms	10,000	<i>g</i>
ESD	Electrostatic discharge protection (HBM)	2	kV
V _{in}	Input voltage on any control pin (including CS, SCL/SPC, SDA/SDI/SDO, SDO/SA0)	0.3 to Vdd_IO +0.3	V

Note: Supply voltage on any pin should never exceed 4.8 V.



This device is sensitive to mechanical shock, improper handling can cause permanent damage to the part.



This device is sensitive to electrostatic discharge (ESD), improper handling can cause permanent damage to the part.

2.6 Terminology

2.6.1 Sensitivity

Linear acceleration sensitivity can be determined, for example, by applying 1 g acceleration to the device. Because the sensor can measure DC accelerations, this can be done easily by pointing the selected axis towards the ground, noting the output value, rotating the sensor 180 degrees (pointing towards the sky) and noting the output value again. By doing so, ± 1 g acceleration is applied to the sensor. Subtracting the larger output value from the smaller one, and dividing the result by 2, leads to the actual sensitivity of the sensor. This value changes very little over temperature and over time. The sensitivity tolerance describes the range of sensitivities of a large number of sensors (see [Table 3](#)).

2.6.2 Zero-g level

Linear acceleration zero-g level offset (TyOff) describes the deviation of an actual output signal from the ideal output signal if no acceleration is present. A sensor in a steady state on a horizontal surface will measure 0 g on both the X-axis and Y-axis, whereas the Z-axis will measure 1 g. Ideally, the output is in the middle of the dynamic range of the sensor (content of OUT registers 00h, data expressed as 2's complement number). A deviation from the ideal value in this case is called zero-g offset.

Offset is to some extent a result of stress to MEMS sensor and therefore the offset can slightly change after mounting the sensor onto a printed circuit board or exposing it to extensive mechanical stress. Offset changes little over temperature, see "Linear acceleration zero-g level change vs. temperature" in [Table 3](#). The zero-g level tolerance (TyOff) describes the standard deviation of the range of zero-g levels of a group of sensors.

3 Digital interface

3.1 SPI interface

The registers embedded inside the IIS3DWB may be accessed through the SPI serial interface that can be SW configured to operate either in 3-wire or 4-wire interface mode. The device is compatible with SPI modes 0 and 3. The SPI interface is mapped to the same pins as an I²C interface. However, since it is only with the throughput of the SPI interface that all the device features and capabilities are supported, the I²C interface is not described. To select/exploit the I²C interface, the CS line must be tied high (i.e connected to Vdd_IO).

Table 7. Serial interface pin description

Pin name	Pin description
CS	SPI enable I ² C ⁽¹⁾ /SPI mode selection (1: SPI idle mode / I ² C ⁽¹⁾ communication enabled; 0: SPI communication mode / I ² C ⁽¹⁾ disabled)
SPC/SCL	SPI serial port clock (SPC) I ² C ⁽¹⁾ serial clock (SCL)
SDI/SDO/SDA	SPI serial data input (SDI) 3-wire interface serial data output (SDO) I ² C ⁽¹⁾ serial data (SDA)
SDO/SA0	SPI 4-wire interface serial data output (SDO) I ² C ⁽¹⁾ least significant bit of the device address (SA0)

1. Only the SPI interface supports all the device features and capabilities. Due to limited throughput, the I²C interface can be used only in single-axis mode and it is not recommended.

3.2 SPI bus interface

The IIS3DWB SPI is a bus slave. The SPI allows writing to and reading from the registers of the device. The serial interface communicates to the application using 4 wires: **CS**, **SPC**, **SDI** and **SDO**.

Figure 3. Read and write protocol (in mode 3)

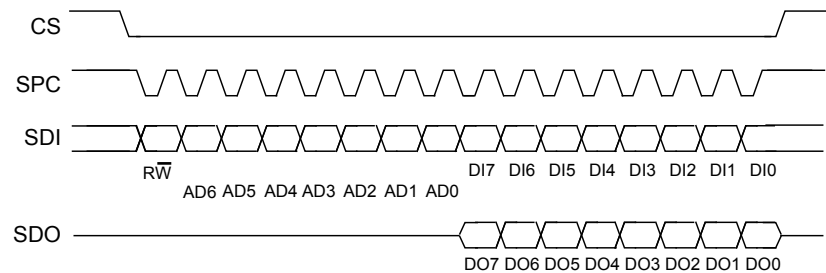

CS is the serial port enable and it is controlled by the SPI master. It goes low at the start of the transmission and goes back high at the end. **SPC** is the serial port clock and it is controlled by the SPI master. It is stopped high when **CS** is high (no transmission). **SDI** and **SDO** are, respectively, the serial port data input and output. Those lines are driven at the falling edge of **SPC** and should be captured at the rising edge of **SPC**.

Both the read register and write register commands are completed in 16 clock pulses or in multiples of 8 in case of multiple read/write bytes. Bit duration is the time between two falling edges of **SPC**. The first bit (bit 0) starts at the first falling edge of **SPC** after the falling edge of **CS** while the last bit (bit 15, bit 23, ...) starts at the last falling edge of **SPC** just before the rising edge of **CS**.

bit 0: \overline{RW} bit. When 0, the data **DI(7:0)** is written into the device. When 1, the data **DO(7:0)** from the device is read. In latter case, the chip will drive **SDO** at the start of bit 8.

bit 1-7: address **AD(6:0)**. This is the address field of the indexed register.

bit 8-15: data **DI(7:0)** (write mode). This is the data that is written into the device (MSb first).

bit 8-15: data **DO(7:0)** (read mode). This is the data that is read from the device (MSb first).

In multiple read/write commands further blocks of 8 clock periods will be added. When the **CTRL3_C (12h)** (**IF_INC**) bit is '0', the address used to read/write data remains the same for every block. When the **CTRL3_C (12h)** (**IF_INC**) bit is '1', the address used to read/write data is increased at every block.

The function and the behavior of **SDI** and **SDO** remain unchanged.

3.2.1 SPI read

Figure 4. SPI read protocol (in mode 3)

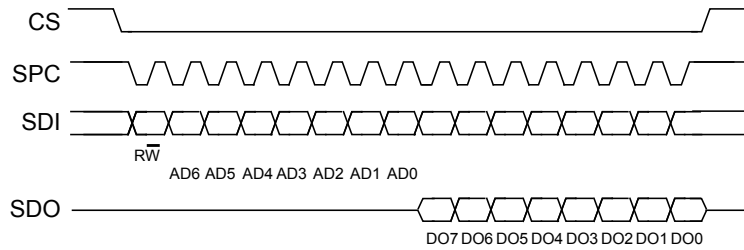

The SPI Read command is performed with 16 clock pulses. A multiple byte read command is performed by adding blocks of 8 clock pulses to the previous one.

bit 0: READ bit. The value is 1.

bit 1-7: address AD(6:0). This is the address field of the indexed register.

bit 8-15: data DO(7:0) (read mode). This is the data that will be read from the device (MSb first).

bit 16-...: data DO(...-8). Further data in multiple byte reads.

Figure 5. Multiple byte SPI read protocol (2-byte example) (in mode 3)

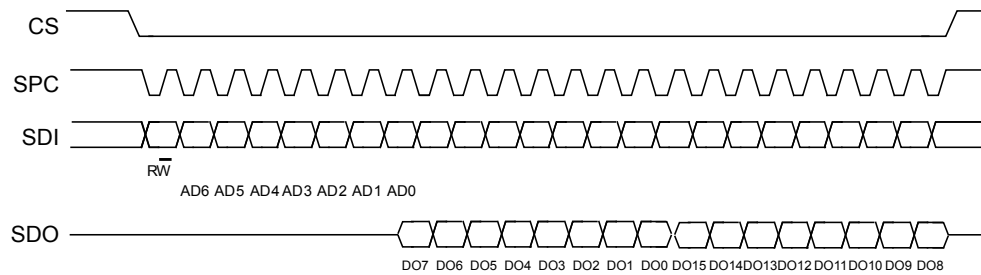

3.2.2 SPI write

Figure 6. SPI write protocol (in mode 3)

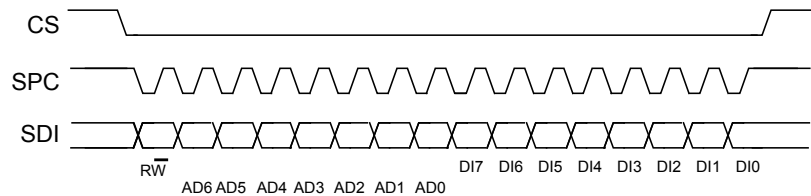

The SPI Write command is performed with 16 clock pulses. A multiple byte write command is performed by adding blocks of 8 clock pulses to the previous one.

bit 0: WRITE bit. The value is 0.

bit 1-7: address AD(6:0). This is the address field of the indexed register.

bit 8-15: data DI(7:0) (write mode). This is the data that is written inside the device (MSb first).

bit 16-... : data DI(...-8). Further data in multiple byte writes.

Figure 7. Multiple byte SPI write protocol (2-byte example) (in mode 3)

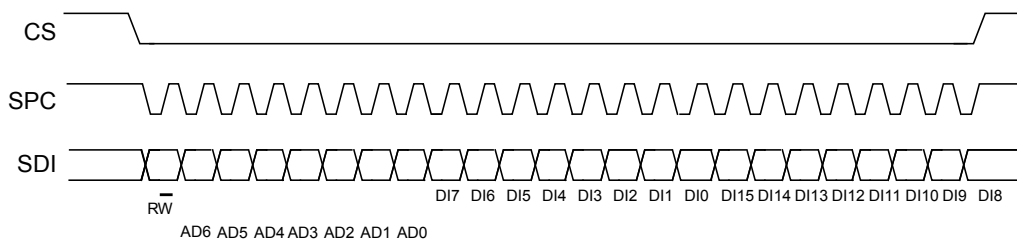

3.2.3 SPI read in 3-wire mode

A 3-wire mode is entered by setting the CTRL3_C (12h) (SIM) bit equal to '1' (SPI serial interface mode selection).

Figure 8. SPI read protocol in 3-wire mode (in mode 3)

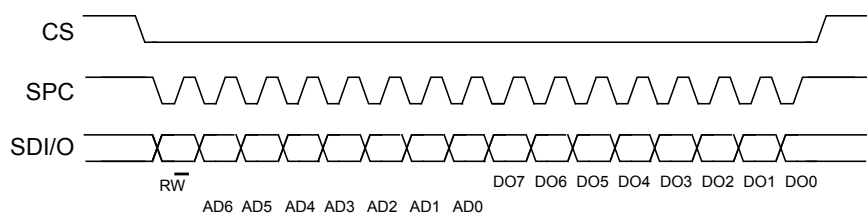

The SPI read command is performed with 16 clock pulses:

bit 0: READ bit. The value is 1.

bit 1-7: address AD(6:0). This is the address field of the indexed register.

bit 8-15: data DO(7:0) (read mode). This is the data that is read from the device (MSb first).

A multiple read command is also available in 3-wire mode.

4 Functionality

4.1 Operating modes

The IIS3DWB has two operating modes:

- 3-axis mode: all three axes (X, Y, Z) are simultaneously active and acceleration data can be read from the sensor concurrently for the 3-axis (using registers `OUTX_L_A` (28h) and `OUTX_H_A` (29h); `OUTY_L_A` (2Ah) and `OUTY_H_A` (2Bh); `OUTZ_L_A` (2Ch) and `OUTZ_H_A` (2Dh) or the FIFO registers: `FIFO_DATA_OUT` (79h – 7Eh)
- single-axis mode: only one axis is active. The active axis, among X or Y or Z, can be selected when the device is in power-down mode. Acceleration data can be read from the registers associated with the active axis or from the corresponding registers of the FIFO.

In single-axis mode, while the power consumption of IIS3DWB remains the same as 3-axis mode, the resolution (noise density) of the active axis significantly improves.

To change the configuration of the active axis, the device should be in power-down mode. An example of the procedure that can be applied is:

Set the device in power-down mode: `CTRL1_XL` (10h) `XL_EN[2:0] = 000b`

Enable the axis: `CTRL6_C` (15h) `XL_AXIS_SEL[1:0] = xxb` (00 = 3 axes; 01 = X-axis; 10 = Y-axis ; 11 = Z-axis)

Enable the device: `CTRL1_XL` (10h) `XL_EN[2:0] = 101b`

4.2 Block diagrams

The IIS3DWB architecture is composed of the following functional blocks:

- MEMS mechanical element
- ADC
- Low-pass digital filter (LPF1)
- Composite filter

Figure 9. Accelerometer architecture

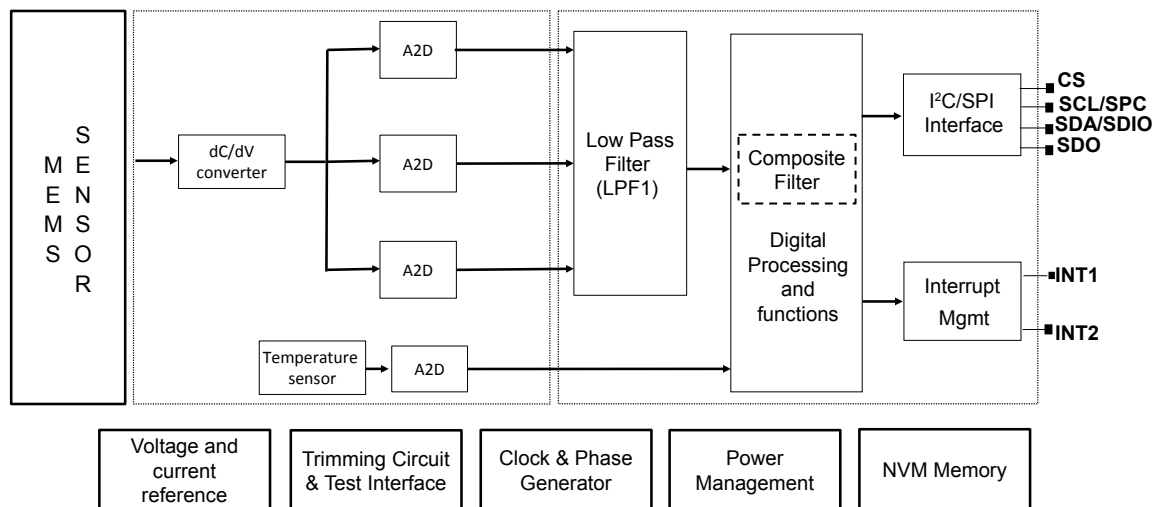
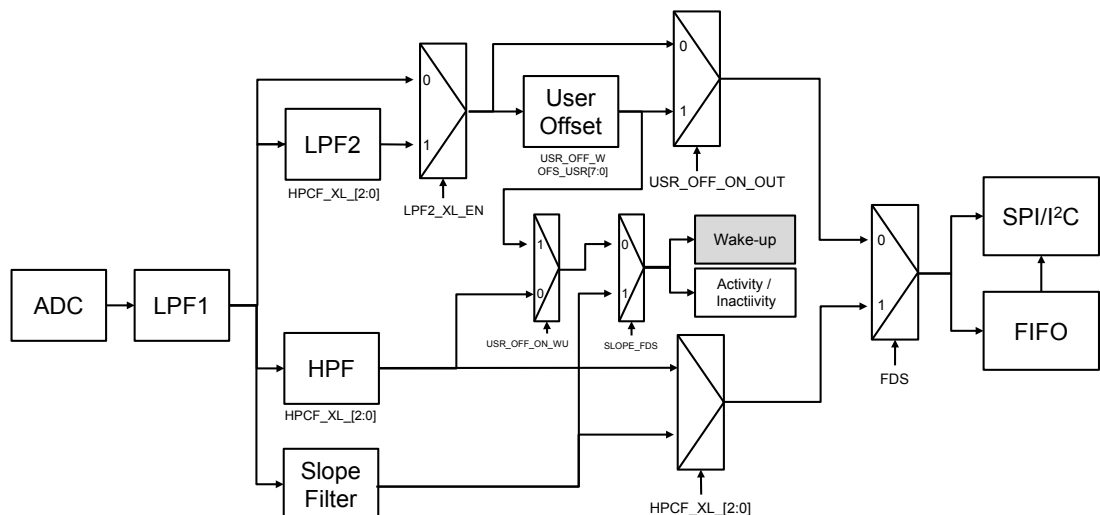

Figure 10. Accelerometer composite filter



4.3 FIFO

The presence of a FIFO allows consistent power saving for the system since the host processor does not need to continuously poll data from the sensor, but it can wake up only when needed and burst the significant data out from the FIFO.

The IIS3DWB embeds 3 kbytes of data in FIFO to store the following data:

- Accelerometer
- Timestamp
- Temperature

Writing data in the FIFO is triggered by the accelerometer data-ready signal.

It is possible to select decimation for timestamp batching in FIFO with a factor of 1, 8, or 32 compared to the accelerometer BDR (Batch Data Rate).

The reconstruction of a FIFO stream is a simple task thanks to the FIFO_DATA_OUT_TAG byte that allows recognizing the meaning of a word in FIFO.

FIFO allows correct reconstruction of the timestamp information for each sensor stored in FIFO. If a change in the BDR configuration is performed, the application can correctly reconstruct the timestamp and know exactly when the change was applied without disabling FIFO batching. FIFO stores information of the new configuration and timestamp in which the change was applied in the device.

The programmable FIFO watermark threshold can be set in FIFO_CTRL1 (07h) and FIFO_CTRL2 (08h) using the WTM[8:0] bits. To monitor the FIFO status, dedicated registers (FIFO_STATUS1 (3Ah), FIFO_STATUS2 (3Bh)) can be read to detect FIFO overrun events, FIFO full status, FIFO empty status, FIFO watermark status and the number of unread samples stored in the FIFO. To generate dedicated interrupts on the INT1 and INT2 pins of these status events, the configuration can be set in INT1_CTRL (0Dh) and INT2_CTRL (0Eh).

The FIFO buffer can be configured according to six different modes:

- Bypass mode
- FIFO mode
- Continuous mode
- Continuous-to-FIFO mode
- Bypass-to-Continuous mode
- Bypass-to-FIFO mode

Each mode is selected by the FIFO_MODE_[2:0] bits in the FIFO_CTRL4 (0Ah) register.

4.3.1 Bypass mode

In Bypass mode (FIFO_CTRL4 (0Ah)(FIFO_MODE_[2:0] = 000), the FIFO is not operational and it remains empty. Bypass mode is also used to reset the FIFO when in FIFO mode.

4.3.2 FIFO mode

In FIFO mode (FIFO_CTRL4 (0Ah)(FIFO_MODE_[2:0] = 001) data from the output channels are stored in the FIFO until it is full.

To reset FIFO content, Bypass mode should be selected by writing FIFO_CTRL4 (0Ah)(FIFO_MODE_[2:0]) to '000'. After this reset command, it is possible to restart FIFO mode by writing FIFO_CTRL4 (0Ah) (FIFO_MODE_[2:0]) to '001'.

The FIFO buffer memorizes up to 3 kbytes of data but the depth of the FIFO can be resized by setting the WTM [8:0] bits in FIFO_CTRL1 (07h) and FIFO_CTRL2 (08h). If the STOP_ON_WTM bit in FIFO_CTRL2 (08h) is set to '1', FIFO depth is limited up to the WTM [8:0] bits in FIFO_CTRL1 (07h) and FIFO_CTRL2 (08h).

4.3.3 Continuous mode

Continuous mode (**FIFO_CTRL4 (0Ah)**(**FIFO_MODE_[2:0] = 110**) provides a continuous FIFO update: as new data arrives, the older data is discarded.

A FIFO threshold flag **FIFO_STATUS2 (3Bh)**(**FIFO_WTM_IA**) is asserted when the number of unread samples in FIFO is greater than or equal to **FIFO_CTRL1 (07h)** and **FIFO_CTRL2 (08h)**(**WTM [8:0]**).

It is possible to route the **FIFO_WTM_IA** flag to the INT1 pin by writing in register **INT1_CTRL (0Dh)** (**INT1_FIFO_TH**) = '1' or to the INT2 pin by writing in register **INT2_CTRL (0Eh)**(**INT2_FIFO_TH**) = '1'.

A full-flag interrupt can be enabled, **INT1_CTRL (0Dh)**(**INT1_FIFO_FULL**) = '1' or **INT2_CTRL (0Eh)** (**INT2_FIFO_FULL**) = '1', in order to indicate FIFO saturation and eventually read its content all at once.

If an overrun occurs, at least one of the oldest samples in FIFO has been overwritten and the **FIFO_OVR_IA** flag in **FIFO_STATUS2 (3Bh)** is asserted.

In order to empty the FIFO before it is full, it is also possible to pull from FIFO the number of unread samples available in **FIFO_STATUS1 (3Ah)** and **FIFO_STATUS2 (3Bh)**(**DIFF_FIFO_[9:0]**).

4.3.4 Continuous-to-FIFO mode

In Continuous-to-FIFO mode (**FIFO_CTRL4 (0Ah)**(**FIFO_MODE_[2:0] = 011**), FIFO behavior changes according to the trigger event (wake-up) detected.

When the selected trigger bit is equal to '1', FIFO operates in FIFO mode.

When the selected trigger bit is equal to '0', FIFO operates in Continuous mode.

4.3.5 Bypass-to-Continuous mode

In Bypass-to-Continuous mode (**FIFO_CTRL4 (0Ah)**(**FIFO_MODE_[2:0] = '100'**), data measurement storage inside FIFO operates in Continuous mode when selected triggers are equal to '1', otherwise FIFO content is reset (Bypass mode).

FIFO behavior changes according to the trigger event detected (wake-up).

4.3.6 Bypass-to-FIFO mode

In Bypass-to-FIFO mode **FIFO_CTRL4 (0Ah)**(**FIFO_MODE_[2:0] = '111'**), data measurement storage inside FIFO operates in FIFO mode when selected triggers (Wake-up) are equal to '1', otherwise FIFO content is reset (Bypass mode)

4.3.7 FIFO reading procedure

The data stored in FIFO are accessible from dedicated registers and each FIFO word is composed of 7 bytes: one tag byte (**FIFO_DATA_OUT_TAG (78h)**), in order to identify the sensor, and 6 bytes of fixed data (**FIFO_DATA_OUT** registers from (79h) to (7Eh)).

The **DIFF_FIFO_[9:0]** field in the **FIFO_STATUS1 (3Ah)** and **FIFO_STATUS2 (3Bh)** registers contains the number of words (1 byte TAG + 6 bytes DATA) collected in FIFO.

In addition, it is possible to configure a counter of the batch events of the sensor. The flag **COUNTER_BDR_IA** in **FIFO_STATUS2 (3Bh)** alerts that the counter has reached a selectable threshold (**CNT_BDR_TH_[10:0]** field in **COUNTER_BDR_REG1 (0Bh)** and **COUNTER_BDR_REG2 (0Ch)**). This allows triggering the reading of FIFO with the desired latency of one single sensor. The sensor is selectable using the **TRIG_COUNTER_BDR** bit in **COUNTER_BDR_REG1 (0Bh)**. As for the other FIFO status events, the flag **COUNTER_BDR_IA** can be routed on the INT1 or INT2 pins by asserting the corresponding bits (**INT1_CNT_BDR** of **INT1_CTRL (0Dh)** and **INT2_CNT_BDR** of **INT2_CTRL (0Eh)**).

5 Frequency response

The IIS3DWB has been specifically designed to provide a wide bandwidth with very flat frequency response in the pass band and a very high attenuation in the stop band so to virtually eliminate any frequency aliasing. The following figure illustrates the filtering chain and its components.

Figure 11. Filtering chain

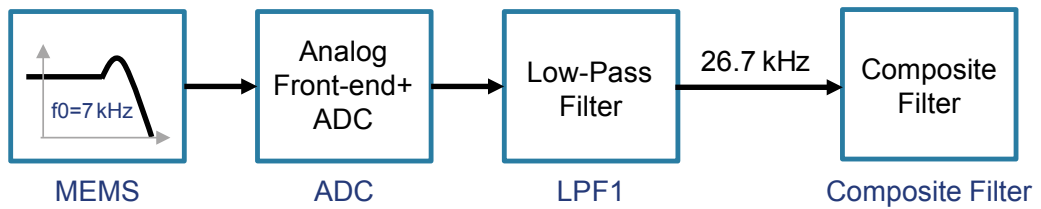

The output of the ADC converter is filtered with a digital low-pass filter to ensure the intended sensor's frequency response. The frequency response at the output of the LPF1 filter is indicated in the following figure.

Figure 12. Frequency response at the output of LPF1 filter

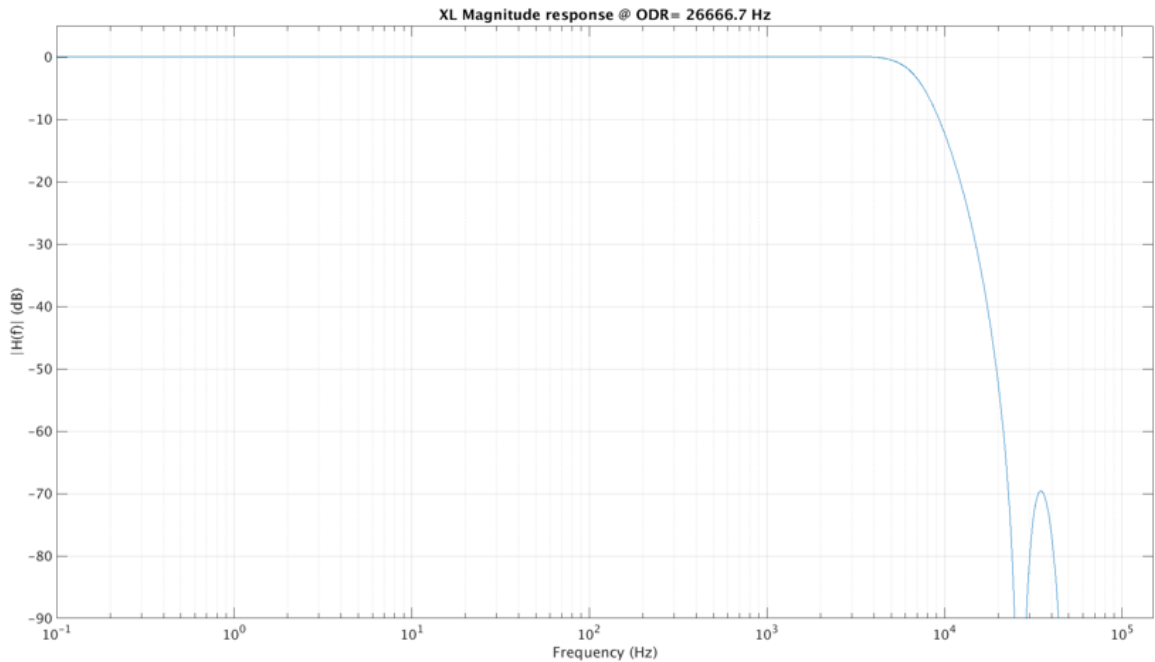

- Sharp out of band roll-off (>90 dB/dec)
- Attenuation >70 dB at frequencies higher than ODR
- High attenuation (>50 dB) and very low folding of spectrum inside signal bandwidth

Note: Frequency response determined by CAD simulation – at the output of LPF1.

After the LPF1 filter, it is possible to enable another level of digital filtering through the digital composite filter (refer to Figure 10. Accelerometer composite filter).

The digital composite filter could be:

- High-pass filter
- Low-pass filter

Figure 13. Frequency response with LPF2 enabled

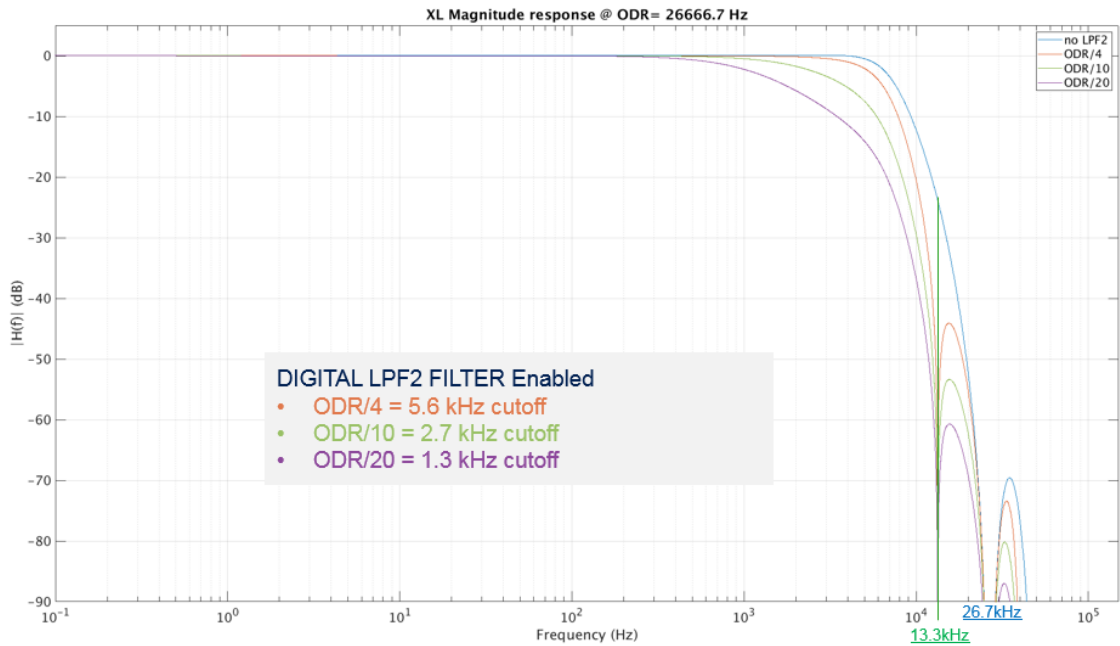

Frequency response at the output of Composite Filter when it is configured as Low-Pass Filter (LPF2)

Note: Frequency response determined by CAD simulation

Figure 14. Frequency response with HPF enabled

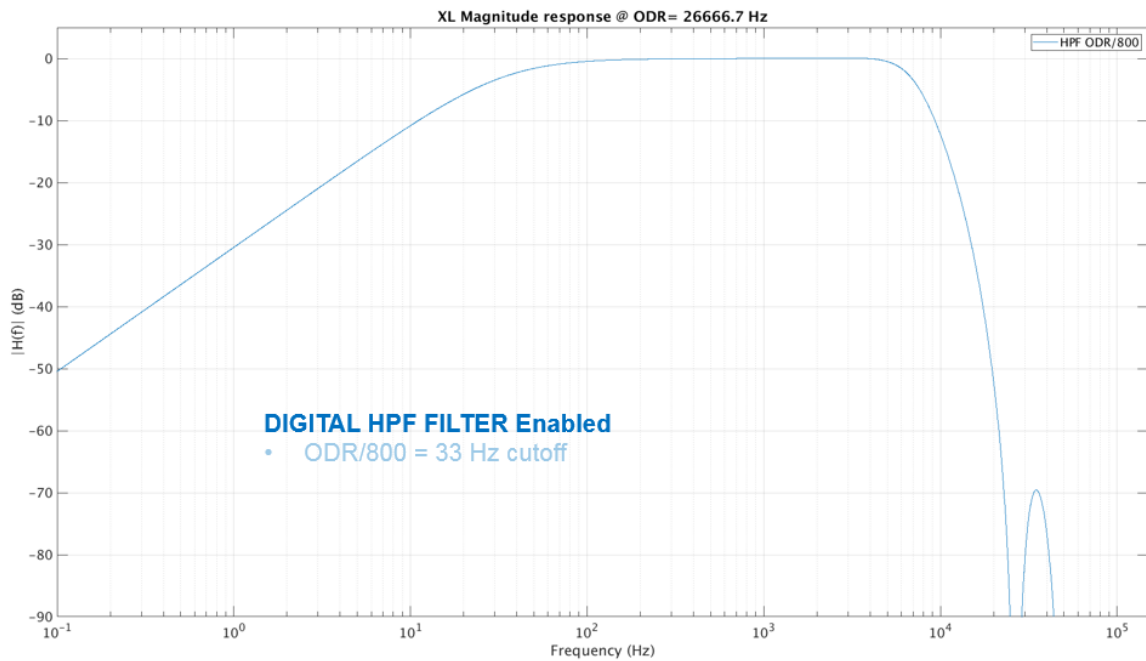

Frequency response at the output of Composite Filter when it is configured as High-Pass Filter (HPF)

Note: Frequency response determined by CAD simulation

6 Typical performance characteristics

6.1 Frequency response measurements

The frequency response of the IIS3DWB, measured on a mechanical shaker, is indicated in the following figures. Measurements have been performed with the IIS3DWB configured with the digital composite filter bypassed.

Figure 15. Frequency response - X-axis

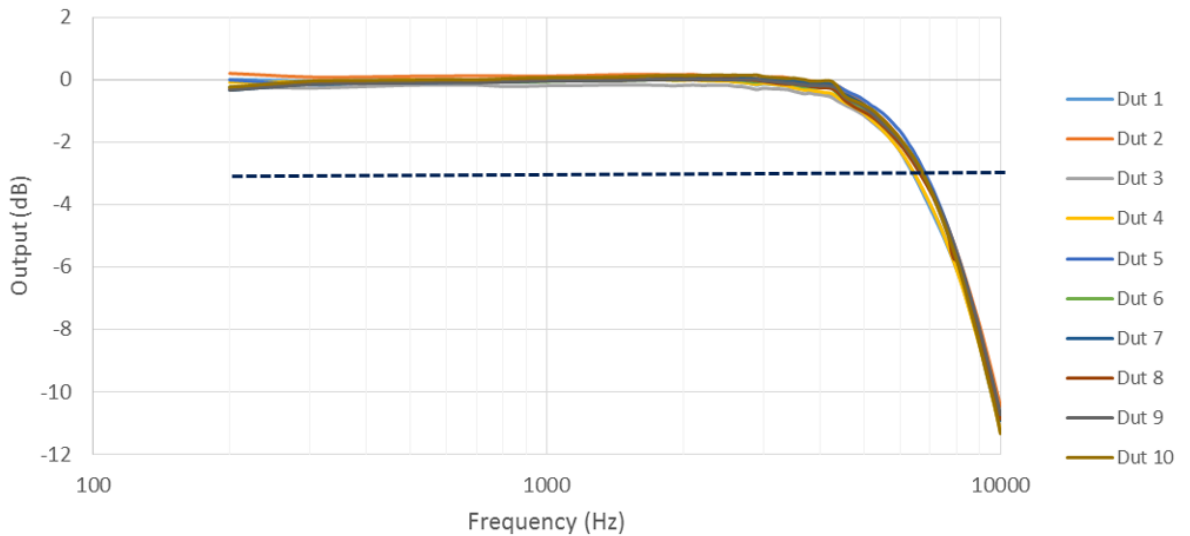

Note: Characterization data on 10 parts. Not measured in production and not guaranteed.

Figure 16. Frequency response - Y-axis

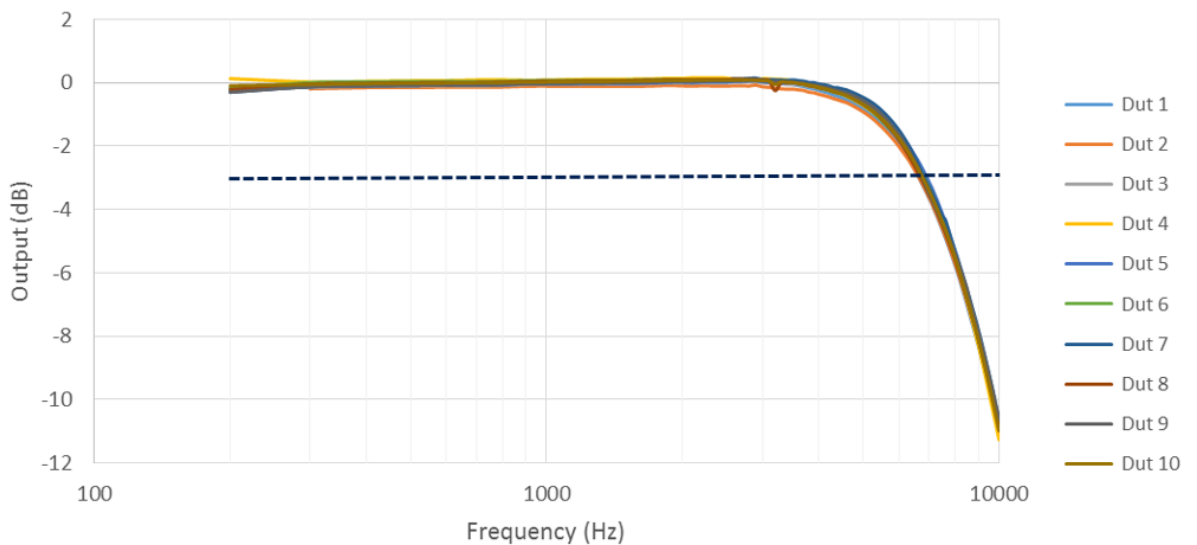

Note: Characterization data on 10 parts. Not measured in production and not guaranteed.

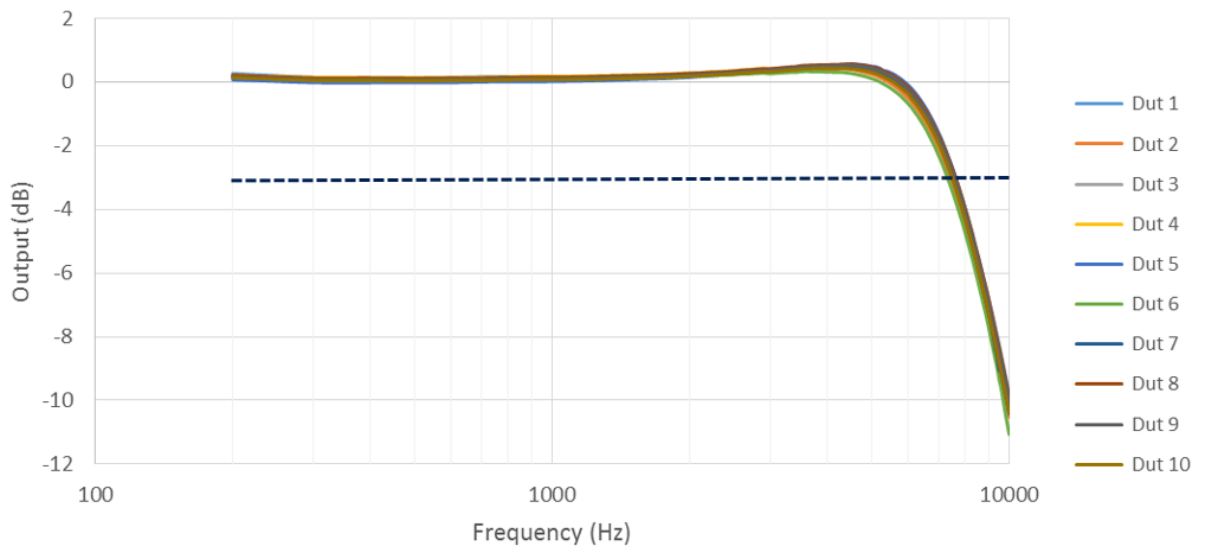
Figure 17. Frequency response - Z-axis

Note: Characterization data on 10 parts. Not measured in production and not guaranteed.

6.2 Sensitivity change versus temperature

Figure 18. Sensitivity change versus temperature

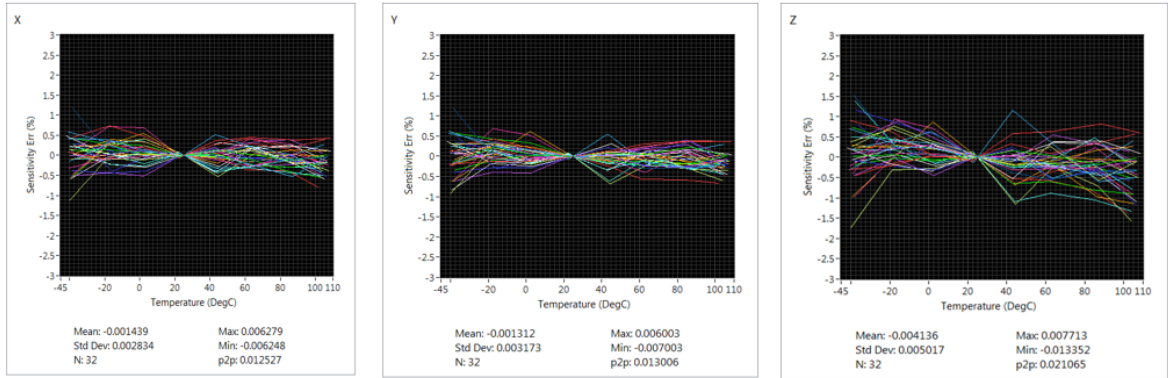

Measured at Vdd 3.0 Volt

Note: Characterization data. Not measured in production and not guaranteed.

6.3 ODR change versus temperature

Figure 19. ODR change versus temperature

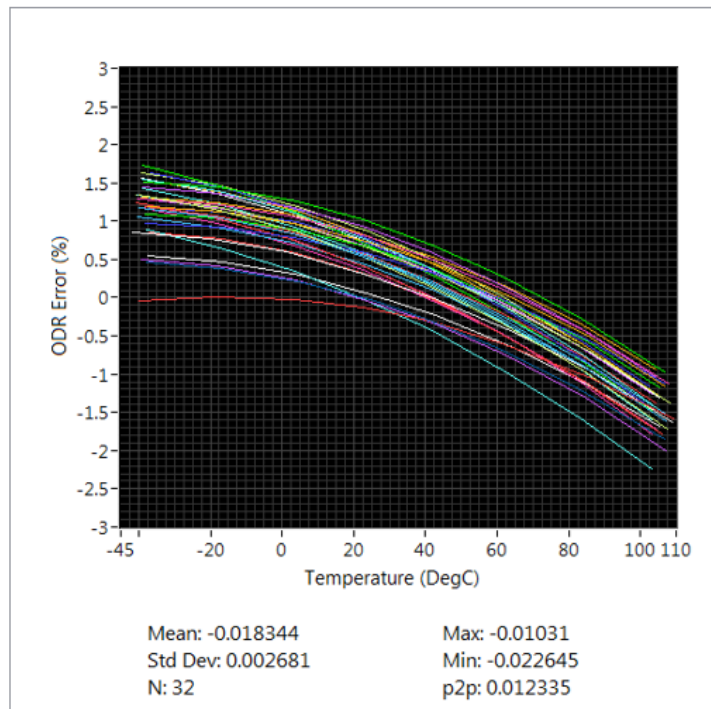

Error evaluated with reference to 26667Hz @ Vdd 3.0 Volt

Note: Characterization data. Not measured in production and not guaranteed.

7 Application hints

7.1 IIS3DWB electrical connections

Figure 20. IIS3DWB electrical connections

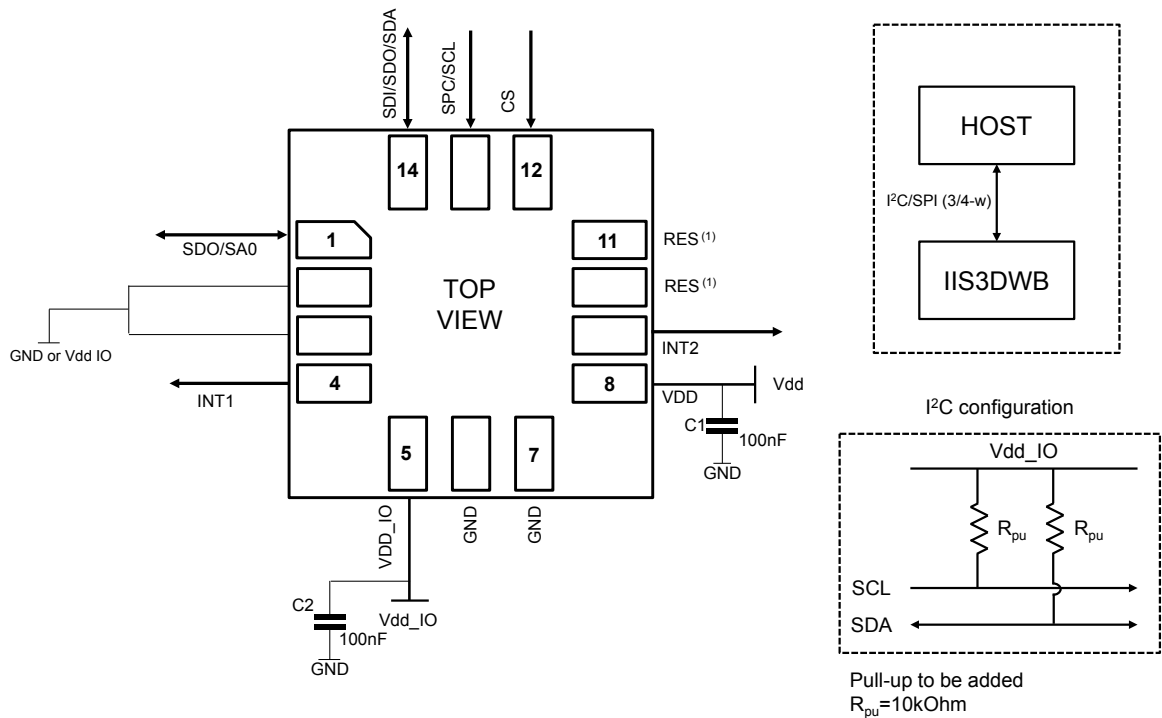

The device core is supplied through the Vdd line while the I/O pads are supplied through the Vdd_IO line. Power supply decoupling capacitors (C1, C2 = 100 nF ceramic) should be placed as near as possible to the the supply pin of the device (common design practice).

The functionality of the device and the measured acceleration data are selectable and accessible through the I²C or SPI interfaces. When using the I²C protocol, CS must be tied high. Every time the CS line is set to low level, the I²C bus is internally reset.

All the functions, the threshold and the timing of the two interrupt pins can be completely programmed by the user through the I²C/SPI interface.

Note: Only the SPI interface supports all the device features and capabilities. The I²C interface can be used only in single-axis mode and it is not recommended.

7.2 Measuring the actual ODR

For applications requiring higher ODR accuracy, it is possible to configure the device to generate an interrupt signal on the INT1/2 pin each time new data is generated. By using an accurate timer (i.e. with a microcontroller) it is possible to measure the time interval between consecutive interrupt signals obtaining a very accurate value of the actual ODR of the device.

In order to enable the generation of the data_ready interrupt on the INT1 or INT2 pin:

- The `dataready_pulsed` bit of the `COUNTER_BDR_REG1 (0Bh)` register should to be set to 1 (optional)
- The `INTx_DRDY_XL` bit of the `INT1_CTRL (0Dh) / INT2_CTRL (0Eh)` register has to be set to 1

Figure 21. Accurately measuring ODR

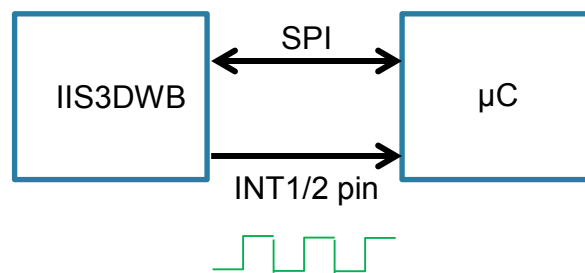

8 Register mapping

The table given below provides a listing of the 8/16-bit registers embedded in the device and the corresponding addresses.

Table 8. Register address map

Name	Type	Register address		Default	Comment
		Hex	Binary		
RESERVED	-	01			
PIN_CTRL	RW	02	00000010	00111111	
RESERVED	-	03-06			
FIFO_CTRL1	RW	07	00000111	00000000	
FIFO_CTRL2	RW	08	00001000	00000000	
FIFO_CTRL3	RW	09	00001001	00000000	
FIFO_CTRL4	RW	0A	00001010	00000000	
COUNTER_BDR_REG1	RW	0B	00001011	00000000	
COUNTER_BDR_REG2	RW	0C	00001100	00000000	
INT1_CTRL	RW	0D	00001101	00000000	
INT2_CTRL	RW	0E	00001110	00000000	
WHO_AM_I	R	0F	00001111	01111011	
CTRL1_XL	RW	10	00010000	00000000	
RESERVED	-	11			
CTRL3_C	RW	12	00010010	00000100	
CTRL4_C	RW	13	00010011	00000000	
CTRL5_C	RW	14	00010100	00000000	
CTRL6_C	RW	15	00010101	00000000	
CTRL7_C	RW	16	00011100	00000000	
CTRL8_XL	RW	17	00010111	00000000	
RESERVED	-	18			
CTRL10_C	RW	19	00011001	00000000	
ALL_INT_SRC	R	1A	00011010	output	
WAKE_UP_SRC	R	1B	00011011	output	
RESERVED	-	1C-1D			
STATUS_REG	R	1E	00011110	output	
RESERVED	-	1F	00011111		
OUT_TEMP_L	R	20	00100000	output	
OUT_TEMP_H	R	21	00100001	output	
RESERVED	-	22-27			
OUTX_L_A	R	28	00101000	output	
OUTX_H_A	R	29	00101001	output	
OUTY_L_A	R	2A	00101010	output	

Name	Type	Register address		Default	Comment
		Hex	Binary		
OUTY_H_A	R	2B	00101011	output	
OUTZ_L_A	R	2C	00101100	output	
OUTZ_H_A	R	2D	00101101	output	
RESERVED	-	2E-39			
FIFO_STATUS1	R	3A	00111010	output	
FIFO_STATUS2	R	3B	00111011	output	
RESERVED	-	3C-3F			
TIMESTAMP0	R	40	01000000	output	
TIMESTAMP1	R	41	01000001	output	
TIMESTAMP2	R	42	01000010	output	
TIMESTAMP3	R	43	01000011	output	
RESERVED	-	44-55			
SLOPE_EN	RW	56	01010111	00000000	
RESERVED	-	57			
INTERRUPTS_EN	RW	58	01011000	00000000	
RESERVED	-	59-5A			
WAKE_UP_THS	RW	5B	01011011	00000000	
WAKE_UP_DUR	RW	5C	01011100	00000000	
RESERVED	-	5D			
MD1_CFG	RW	5E	01011110	00000000	
MD2_CFG	RW	5F	01011111	00000000	
RESERVED	-	60-62			
INTERNAL_FREQ_FINE	R	63	01100011	output	
RESERVED	-	64-72			
X_OFS_USR	RW	73	01110011	00000000	
Y_OFS_USR	RW	74	01110100	00000000	
Z_OFS_USR	RW	75	01110101	00000000	
RESERVED	-	76-77			
FIFO_DATA_OUT_TAG	R	78	01111000	output	
FIFO_DATA_OUT_X_L	R	79	01111001	output	
FIFO_DATA_OUT_X_H	R	7A	01111010	output	
FIFO_DATA_OUT_Y_L	R	7B	01111011	output	
FIFO_DATA_OUT_Y_H	R	7C	01111100	output	
FIFO_DATA_OUT_Z_L	R	7D	01111101	output	
FIFO_DATA_OUT_Z_H	R	7E	01111110	output	

9 Register description

9.1 PIN_CTRL (02h)

SDO pin pull-up enable/disable register (r/w)

Table 9. PIN_CTRL register

0	SDO_PU_EN	1	1	1	1	1	1
---	-----------	---	---	---	---	---	---

Table 10. PIN_CTRL register description

SDO_PU_EN	Enable pull-up on SDO pin (0: SDO pin pull-up disconnected (default); 1: SDO pin with pull-up)
-----------	---

9.2 FIFO_CTRL1 (07h)

FIFO control register 1 (r/w)

Table 11. FIFO_CTRL1 register

WTM7	WTM6	WTM5	WTM4	WTM3	WTM2	WTM1	WTM0
------	------	------	------	------	------	------	------

Table 12. FIFO_CTRL1 register description

WTM[7:0]	FIFO watermark threshold, in conjunction with WTM8 in FIFO_CTRL2 (08h). 1 LSB = 1 sensor (6 bytes) + TAG (1 byte) written in FIFO Watermark flag rises when the number of bytes written in the FIFO is greater than or equal to the threshold level.
----------	--

9.3 FIFO_CTRL2 (08h)

FIFO control register 2 (r/w)

Table 13. FIFO_CTRL2 register

STOP_ON_WTM	0 ⁽¹⁾	0 ⁽¹⁾	0 ⁽¹⁾	0 ⁽¹⁾	0 ⁽¹⁾	0 ⁽¹⁾	WTM8
-------------	------------------	------------------	------------------	------------------	------------------	------------------	------

1. This bit must be set to '0' for the correct operation of the device.

Table 14. FIFO_CTRL2 register description

STOP_ON_WTM	Sensing chain FIFO stop values memorization at threshold level (0: FIFO depth is not limited (default); 1: FIFO depth is limited to threshold level, defined in FIFO_CTRL1 (07h) and FIFO_CTRL2 (08h))
WTM8	FIFO watermark threshold, in conjunction with WTM_FIFO[7:0] in FIFO_CTRL1 (07h) 1 LSB = 1 sensor (6 bytes) + TAG (1 byte) written in FIFO Watermark flag rises when the number of bytes written in the FIFO is greater than or equal to the threshold level.

9.4 FIFO_CTRL3 (09h)

FIFO control register 3 (r/w)

Table 15. FIFO_CTRL3 register

0 ⁽¹⁾	0 ⁽¹⁾	0 ⁽¹⁾	0 ⁽¹⁾	BDR_XL_3	BDR_XL_2	BDR_XL_1	BDR_XL_0
------------------	------------------	------------------	------------------	----------	----------	----------	----------

1. This bit must be set to '0' for the correct operation of the device.

Table 16. FIFO_CTRL3 register description

BDR_XL_[3:0]	Selects Batch Data Rate (write frequency in FIFO) for accelerometer data. (0000: Accelerometer not batched in FIFO (default); 1010: 26667 Hz; 1011 - 1111: not allowed)
--------------	--

9.5 FIFO_CTRL4 (0Ah)

FIFO control register 4 (r/w)

Table 17. FIFO_CTRL4 register

DEC_TS_BATCH_1	DEC_TS_BATCH_0	ODR_T_BATCH_1	ODR_T_BATCH_0	0 ⁽¹⁾	FIFO_MODE_2	FIFO_MODE_1	FIFO_MODE_0
----------------	----------------	---------------	---------------	------------------	-------------	-------------	-------------

1. This bit must be set to '0' for the correct operation of the device.

Table 18. FIFO_CTRL4 register description

DEC_TS_BATCH[1:0]	Selects decimation for timestamp batching in FIFO. Write rate will be the rate between XL BDR divided by decimation decoder. (00: Timestamp not batched in FIFO (default); 01: Decimation 1: BDR_XL[Hz]; 10: Decimation 8: BDR_XL[Hz]/8; 11: Decimation 32: BDR_XL[Hz]/32)
ODR_T_BATCH[1:0]	Selects batch data rate (write frequency in FIFO) for temperature data (00: Temperature not batched in FIFO (default); 11: 104 Hz)
FIFO_MODE[2:0]	FIFO mode selection (000: Bypass mode: FIFO disabled; 001: FIFO mode: stops collecting data when FIFO is full; 010: Reserved; 011: Continuous-to-FIFO mode: Continuous mode until trigger is deasserted, then FIFO mode; 100: Bypass-to-Continuous mode: Bypass mode until trigger is deasserted, then Continuous mode; 101: Reserved; 110: Continuous mode: if the FIFO is full, the new sample overwrites the older one; 111: Bypass-to-FIFO mode: Bypass mode until trigger is deasserted, then FIFO mode.)

9.6 COUNTER_BDR_REG1 (0Bh)

Counter batch data rate register 1 (r/w)

Table 19. COUNTER_BDR_REG1 register

dataready_pulsed	RST_COUNTER_BDR	0 ⁽¹⁾	0 ⁽¹⁾	0 ⁽¹⁾	CNT_BDR_TH_10	CNT_BDR_TH_9	CNT_BDR_TH_8
------------------	-----------------	------------------	------------------	------------------	---------------	--------------	--------------

1. This bit must be set to '0' for the correct operation of the device.

Table 20. COUNTER_BDR_REG1 register description

dataready_pulsed	Enables pulsed data-ready mode (0: Data-ready latched mode (returns to 0 only after an interface reading) (default); 1: Data-ready pulsed mode (the data ready pulses are 18.75 µs long)
RST_COUNTER_BDR	Resets the internal counter of batch events. This bit is automatically reset to zero if it was set to '1'.
CNT_BDR_TH_[10:8]	In conjunction with CNT_BDR_TH[7:0] in COUNTER_BDR_REG2 (0Ch) , sets the threshold for the internal counter of batch events. When this counter reaches the threshold, the counter is reset and the COUNTER_BDR_IA flag in FIFO_STATUS2 (3Bh) is set to '1'.

9.7 COUNTER_BDR_REG2 (0Ch)

Counter batch data rate register 2(r/w)

Table 21. COUNTER_BDR_REG2 register

CNT_BDR_TH_7	CNT_BDR_TH_6	CNT_BDR_TH_5	CNT_BDR_TH_4	CNT_BDR_TH_3	CNT_BDR_TH_2	CNT_BDR_TH_1	CNT_BDR_TH_0
--------------	--------------	--------------	--------------	--------------	--------------	--------------	--------------

Table 22. COUNTER_BDR_REG2 register description

CNT_BDR_TH_[7:0]	In conjunction with CNT_BDR_TH[10:8] in COUNTER_BDR_REG1 (0Bh) , sets the threshold for the internal counter of batch events. When this counter reaches the threshold, the counter is reset and the COUNTER_BDR_IA flag in FIFO_STATUS2 (3Bh) is set to '1'.
------------------	--

9.8 INT1_CTRL (0Dh)

INT1 pin control register (r/w)

Each bit in this register enables a signal to be carried over INT1.

Table 23. INT1_CTRL register

0 ⁽¹⁾	INT1_CNT_BDR	INT1_FIFO_FULL	INT1_FIFO_OVR	INT1_FIFO_TH	INT1_BOOT	0 ⁽¹⁾	INT1_DRDY_XL
------------------	--------------	----------------	---------------	--------------	-----------	------------------	--------------

1. This bit must be set to '0' for the correct operation of the device.

Table 24. INT1_CTRL register description

INT1_CNT_BDR	Enables COUNTER_BDR_IA interrupt on INT1.
INT1_FIFO_FULL	Enables FIFO full flag interrupt on INT1 pin.
INT1_FIFO_OVR	Enables FIFO overrun interrupt on INT1 pin.
INT1_FIFO_TH	Enables FIFO threshold interrupt on INT1 pin.
INT1_BOOT	Enables boot status on INT1 pin
INT1_DRDY_XL	Enables accelerometer data-ready interrupt on INT1 pin.

9.9 INT2_CTRL (0Eh)

INT2 pin control register (r/w)

Each bit in this register enables a signal to be carried over INT2.

Table 25. INT2_CTRL register

0 ⁽¹⁾	INT2_CNT_BDR	INT2_FIFO_FULL	INT2_FIFO_OVR	INT2_FIFO_TH	INT2_DRDY_TEMP	0 ⁽¹⁾	INT2_DRDY_XL
------------------	--------------	----------------	---------------	--------------	----------------	------------------	--------------

1. This bit must be set to '0' for the correct operation of the device.

Table 26. INT2_CTRL register description

INT2_CNT_BDR	Enables COUNTER_BDR_IA interrupt on INT2.
INT2_FIFO_FULL	Enables FIFO full flag interrupt on INT2 pin.
INT2_FIFO_OVR	Enables FIFO overrun interrupt on INT2 pin.
INT2_FIFO_TH	Enables FIFO threshold interrupt on INT2 pin.
INT2_DRDY_TEMP	Enables temperature sensor data-ready interrupt on INT2 pin.
INT2_DRDY_XL	Enables accelerometer data-ready interrupt on INT2 pin.

9.10 WHO_AM_I (0Fh)

Device identification register

Table 27. WHO_AM_I register

0	1	1	1	1	0	1	1
---	---	---	---	---	---	---	---

9.11 CTRL1_XL (10h)

Accelerometer control register 1 (r/w)

Table 28. CTRL1_XL register

XL_EN_2	XL_EN_1	XL_EN_0	0 ⁽¹⁾	FS1_XL	FS0_XL	LPF2_XL_EN	0 ⁽¹⁾
---------	---------	---------	------------------	--------	--------	------------	------------------

1. This bit must be set to '0' for the correct operation of the device.

Table 29. CTRL1_XL register description

XL_EN[2:0]	Enables accelerometer: (000: Power-down (default); 101: accelerometer enabled;) All other configurations are not allowed.
FS[1:0]_XL	Selects accelerometer full-scale (see Table 30).
LPF2_XL_EN	Selects accelerometer high-resolution. (0: output from first stage digital filtering selected (default); 1: output from LPF2 second filtering stage selected)

Table 30. Accelerometer full-scale selection

FS[1:0]_XL	Full scale
00 (default)	±2 g
01	±16 g
10	±4 g
11	±8 g

9.12 CTRL3_C (12h)

Control register 3 (r/w)

Table 31. CTRL3_C register

BOOT	BDU	H_LACTIVE	PP_OD	SIM	IF_INC	0 ⁽¹⁾	SW_RESET
------	-----	-----------	-------	-----	--------	------------------	----------

1. This bit must be set to '0' for the correct operation of the device.

Table 32. CTRL3_C register description

BOOT	Reboots memory content. Default value: 0 (0: normal mode; 1: reboot memory content) Note: the accelerometer must be ON. This bit is automatically cleared.
BDU	Block Data Update. Default value: 0 (0: continuous update; 1: output registers are not updated until MSB and LSB have been read)
H_LACTIVE	Interrupt activation level. Default value: 0 (0: interrupt output pins active high; 1: interrupt output pins active low)
PP_OD	Push-pull/open-drain selection on INT1 and INT2 pins. Default value: 0 (0: push-pull mode; 1: open-drain mode)
SIM	SPI Serial Interface Mode selection. Default value: 0 (0: 4-wire interface; 1: 3-wire interface)
IF_INC	Register address automatically incremented during a multiple byte access with a serial interface (I ² C or SPI). Default value: 1 (0: disabled; 1: enabled)
SW_RESET	Software reset. Default value: 0 (0: normal mode; 1: reset device) This bit is automatically cleared.

9.13 CTRL4_C (13h)

Control register 4 (r/w)

Table 33. CTRL4_C register

0 ⁽¹⁾	0 ⁽¹⁾	INT2_on_INT1	0 ⁽¹⁾	DRDY_MASK	I2C_disable	0 ⁽¹⁾	1AX_TO_3REGOUT
------------------	------------------	--------------	------------------	-----------	-------------	------------------	----------------

1. This bit must be set to '0' for the correct operation of the device.

Table 34. CTRL4_C register description

INT2_on_INT1	Enables bit to route all interrupt signals available on INT1 pin. Default value: 0 (0: interrupt signals divided between INT1 and INT2 pins; 1: all interrupt signals in logic OR on INT1 pin)
DRDY_MASK	Enables data available (0: disabled; 1: mask DRDY on pin until filter settling ends.
I2C_disable	Disables I ² C interface. Default value: 0 (0: SPI and I ² C interfaces enabled (default); 1: I ² C interface disabled)
1AX_TO_3REGOUT	In single-axis mode, uses output of XYZ registers to give 3 consecutive samples of the selected single axis.

9.14 CTRL5_C (14h)

Control register 5 (r/w)

Table 35. CTRL5_C register

0 ⁽¹⁾	ROUNDING1	ROUNDING0	0 ⁽¹⁾	0 ⁽¹⁾	0 ⁽¹⁾	ST1_XL	ST0_XL
------------------	-----------	-----------	------------------	------------------	------------------	--------	--------

1. This bit must be set to '0' for the correct operation of the device.

Table 36. CTRL5_C register description

ROUNDING[1:0]	Circular burst-mode (rounding) read from the output registers. Default value: 00 (00: no rounding; 01: rounding enabled)
ST[1:0]_XL	Linear acceleration sensor self-test enable. Default value: 00 (00: Self-test disabled; Other: refer to Table 37)

Table 37. Linear acceleration sensor self-test mode selection

ST1_XL	ST0_XL	Self-test mode
0	0	Normal mode
0	1	Positive sign self-test
1	0	Negative sign self-test
1	1	Not allowed

9.15 CTRL6_C (15h)

Control register 6 (r/w)

Table 38. CTRL6_C register

0 ⁽¹⁾	0 ⁽¹⁾	0 ⁽¹⁾	0 ⁽¹⁾	USR_OFF_W	0 ⁽¹⁾	XL_AXIS_SEL_1	XL_AXIS_SEL_0
------------------	------------------	------------------	------------------	-----------	------------------	---------------	---------------

1. This bit must be set to '0' for the correct operation of the device.

Table 39. CTRL6_C register description

USR_OFF_W	Weight of XL user offset bits of registers X_OFS_USR (73h), Y_OFS_USR (74h), Z_OFS_USR (75h) (0 = 2 ⁻¹⁰ g/LSB; 1 = 2 ⁻⁶ g/LSB)
XL_AXIS_SEL[1:0]	Selects the active axis of the accelerometer in single-axis mode. Refer to Table 40 The selection or the switching of the active axis (3 axes or 1 axis among X, Y, Z) should be performed when the device is in power-down condition

Table 40. Accelerometer active axis

XL_AXIS_SEL[1:0]	Active axis
00 (default)	3 axes (XYZ)
01	X-axis
10	Y-axis
11	Z-axis

9.16 CTRL7_C (16h)

Control register 7 (r/w)

Table 41. CTRL7_C register

0 ⁽¹⁾	0 ⁽¹⁾	0 ⁽¹⁾	0 ⁽¹⁾	0 ⁽¹⁾	0 ⁽¹⁾	USR_OFF_ON_OUT	0 ⁽¹⁾
------------------	------------------	------------------	------------------	------------------	------------------	----------------	------------------

1. This bit must be set to '0' for the correct operation of the device.

Table 42. CTRL7_C register description

USR_OFF_ON_OUT	Enables the accelerometer user offset correction block; it's valid for the low-pass path - see Figure 10. Accelerometer composite filter. Default value: 0 (0: accelerometer user offset correction block bypassed; (1: accelerometer user offset correction block enabled)
----------------	---

9.17 CTRL8_XL (17h)

Control register 8 (r/w)

Table 43. CTRL8_XL register

HPCF_XL_2	HPCF_XL_1	HPCF_XL_0	HP_REF_MODE_XL	FASTSETTL_MODE_XL	FDS	0 ⁽¹⁾	0 ⁽¹⁾
-----------	-----------	-----------	----------------	-------------------	-----	------------------	------------------

1. This bit must be set to '0' for the correct operation of the device.

Table 44. CTRL8_XL register description

HPCF_XL[2:0]	Accelerometer LPF2 and HP filter configuration and cutoff setting. Refer to Table 45.
HP_REF_MODE_XL	Enables accelerometer high-pass filter reference mode (valid for high-pass path - FDS bit must be '1' and HPCF_XL[2:0] must be set to "111"). Default value: 0 ⁽¹⁾ (0: disabled, 1: enabled)
FASTSETTL_MODE_XL	Enables accelerometer LPF2 and HPF fast-settling mode. The filter sets the second samples after writing this bit. Default value: 0 (0: disabled, 1: enabled)
FDS	Accelerometer low-pass / high-pass filter selection. Refer to Figure 10.

1. When enabled, the first output data have to be discarded.

Table 45. Accelerometer bandwidth configurations

Filter type	FDS	LPF2_XL_EN	HPCF_XL[2:0]	Bandwidth
Low pass	0	0	-	6.3 kHz
			000	ODR/4
		1	001	ODR/10
			010	ODR/20
			011	ODR/45
			100	ODR/100
			101	ODR/200
			110	ODR/400
			111	ODR/800
			High pass	1
001	ODR/10			
010	ODR/20			
011	ODR/45			
100	ODR/100			
101	ODR/200			
110	ODR/400			
111	ODR/800			

9.18 CTRL10_C (19h)

Control register 10 (r/w)

Table 46. CTRL10_C register

0 ⁽¹⁾	0 ⁽¹⁾	TIMESTAMP_EN	0 ⁽¹⁾	0 ⁽¹⁾	0 ⁽¹⁾	0 ⁽¹⁾	0 ⁽¹⁾
------------------	------------------	--------------	------------------	------------------	------------------	------------------	------------------

1. This bit must be set to '0' for the correct operation of the device.

Table 47. CTRL10_C register description

TIMESTAMP_EN	<p>Enables timestamp counter. Default value: 0 (0: disabled; 1: enabled)</p> <p>The counter is readable in TIMESTAMP0 (40h), TIMESTAMP1 (41h), TIMESTAMP2 (42h), and TIMESTAMP3 (43h).</p>
--------------	--

9.19 ALL_INT_SRC (1Ah)

Source register for all interrupts (r)

Table 48. ALL_INT_SRC register

TIMESTAMP_ENDCOUNT	0	SLEEP_CHANGE_IA	0	0	0	WU_IA	0
--------------------	---	-----------------	---	---	---	-------	---

Table 49. ALL_INT_SRC register description

TIMESTAMP_ENDCOUNT	Alerts timestamp overflow within 6.4 ms
SLEEP_CHANGE_IA	<p>Detects change event in activity/inactivity status. Default value: 0 (0: change status not detected; 1: change status detected)</p>
WU_IA	<p>Wake-up event status. Default value: 0 (0: event not detected, 1: event detected)</p>

9.20 WAKE_UP_SRC (1Bh)

Wake-up interrupt source register (r)

Table 50. WAKE_UP_SRC register

0	SLEEP_CHANGE_IA	0	SLEEP_STATE_IA	WU_IA	X_WU	Y_WU	Z_WU
---	-----------------	---	----------------	-------	------	------	------

Table 51. WAKE_UP_SRC register description

SLEEP_CHANGE_IA	Detects change event in activity/inactivity status. Default value: 0 (0: change status not detected; 1: change status detected)
SLEEP_STATE_IA	Sleep event status. Default value: 0 (0: sleep event not detected; 1: sleep event detected)
WU_IA	Wakeup event detection status. Default value: 0 (0: wakeup event not detected; 1: wakeup event detected.)
X_WU	Wakeup event detection status on X-axis. Default value: 0 (0: wakeup event on X-axis not detected; 1: wakeup event on X-axis detected)
Y_WU	Wakeup event detection status on Y-axis. Default value: 0 (0: wakeup event on Y-axis not detected; 1: wakeup event on Y-axis detected)
Z_WU	Wakeup event detection status on Z-axis. Default value: 0 (0: wakeup event on Z-axis not detected; 1: wakeup event on Z-axis detected)

9.21 STATUS_REG (1Eh)

Status register (r)

Table 52. STATUS_REG register

0	0	0	0	0	TDA	0	XLDA
---	---	---	---	---	-----	---	------

Table 53. STATUS_REG register description

TDA	Temperature new data available. Default: 0 (0: no set of data is available at temperature sensor output; 1: a new set of data is available at temperature sensor output)
XLDA	Accelerometer new data available. Default value: 0 (0: no set of data available at accelerometer output; 1: a new set of data is available at accelerometer output)

9.22 OUT_TEMP_L (20h), OUT_TEMP_H (21h)

Temperature data output register (r). L and H registers together express a 16-bit word in two's complement.

Table 54. OUT_TEMP_L register

Temp7	Temp6	Temp5	Temp4	Temp3	Temp2	Temp1	Temp0
-------	-------	-------	-------	-------	-------	-------	-------

Table 55. OUT_TEMP_H register

Temp15	Temp14	Temp13	Temp12	Temp11	Temp10	Temp9	Temp8
--------	--------	--------	--------	--------	--------	-------	-------

Table 56. OUT_TEMP register description

Temp[15:0]	Temperature sensor output data The value is expressed as two's complement sign extended on the MSB.
------------	--

9.23 OUTX_L_A (28h) and OUTX_H_A (29h)

Linear acceleration sensor X-axis output register (r). The value is expressed as a 16-bit word in two's complement.

Table 57. OUTX_L_A register

D7	D6	D5	D4	D3	D2	D1	D0
----	----	----	----	----	----	----	----

Table 58. OUTX_H_A register

D15	D14	D13	D12	D11	D10	D9	D8
-----	-----	-----	-----	-----	-----	----	----

Table 59. OUTX_H_A register description

D[15:0]	X-axis linear acceleration value D[15:0] expressed in two's complement
---------	---

9.24 OUTY_L_A (2Ah) and OUTY_H_A (2Bh)

Linear acceleration sensor Y-axis output register (r). The value is expressed as a 16-bit word in two's complement.

Table 60. OUTY_L_A register

D7	D6	D5	D4	D3	D2	D1	D0
----	----	----	----	----	----	----	----

Table 61. OUTY_H_A register

D15	D14	D13	D12	D11	D10	D9	D8
-----	-----	-----	-----	-----	-----	----	----

Table 62. OUTY_H_A register description

D[15:0]	Y-axis linear acceleration value D[15:0] expressed in two's complement
---------	---

9.25 OUTZ_L_A (2Ch) and OUTZ_H_A (2Dh)

Linear acceleration sensor Z-axis output register (r). The value is expressed as a 16-bit word in two's complement.

Table 63. OUTZ_L_A register

D7	D6	D5	D4	D3	D2	D1	D0
----	----	----	----	----	----	----	----

Table 64. OUTZ_H_A register

D15	D14	D13	D12	D11	D10	D9	D8
-----	-----	-----	-----	-----	-----	----	----

Table 65. OUTZ_H_A register description

D[15:0]	Z-axis linear acceleration value D[15:0] expressed in two's complement
---------	---

9.26 FIFO_STATUS1 (3Ah)

FIFO status register 1 (r)

Table 66. FIFO_STATUS1 register

DIFF_FIF0_7	DIFF_FIF0_6	DIFF_FIF0_5	DIFF_FIF0_4	DIFF_FIF0_3	DIFF_FIF0_2	DIFF_FIF0_1	DIFF_FIF0_0
-------------	-------------	-------------	-------------	-------------	-------------	-------------	-------------

Table 67. FIFO_STATUS1 register description

DIFF_FIF0_[7:0]	Number of unread sensor data (TAG + 6 bytes) stored in FIFO In conjunction with DIFF_FIF0[9:8] in FIFO_STATUS2 (3Bh).
-----------------	--

9.27 FIFO_STATUS2 (3Bh)

FIFO status register 2 (r)

Table 68. FIFO_STATUS2 register

FIF0_WTM_IA	FIF0_OVR_IA	FIF0_FULL_IA	COUNTER_BDR_IA	FIF0_OVR_LATCHED	0	DIFF_FIF0_9	DIFF_FIF0_8
-------------	-------------	--------------	----------------	------------------	---	-------------	-------------

Table 69. FIFO_STATUS2 register description

FIF0_WTM_IA	FIFO watermark status. Default value: 0 (0: FIFO filling is lower than WTM; 1: FIFO filling is equal to or greater than WTM) Watermark is set through bits WTM[8:0] in FIF0_CTRL2 (08h) and FIF0_CTRL1 (07h).
FIF0_OVR_IA	FIFO overrun status. Default value: 0 (0: FIFO is not completely filled; 1: FIFO is completely filled)
FIF0_FULL_IA	Smart FIFO full status. Default value: 0 (0: FIFO is not full; 1: FIFO will be full at the next ODR)
COUNTER_BDR_IA	Counter BDR reaches the CNT_BDR_TH_[10:0] threshold set in COUNTER_BDR_REG1 (0Bh) and COUNTER_BDR_REG2 (0Ch). Default value: 0 This bit is reset when these registers are read.
FIF0_OVR_LATCHED	Latched FIFO overrun status. Default value: 0 This bit is reset when this register is read.
DIFF_FIF0_[9:8]	Number of unread sensor data (TAG + 6 bytes) stored in FIFO. Default value: 00 In conjunction with DIFF_FIF0[7:0] in FIF0_STATUS1 (3Ah)

9.28 **TIMESTAMP0 (40h), TIMESTAMP1 (41h), TIMESTAMP2 (42h), and TIMESTAMP3 (43h)**

Timestamp first data output register (r). The value is expressed as a 32-bit word and the bit resolution is 12.5 μ s.

Table 70. TIMESTAMP output registers

D31	D30	D29	D28	D27	D26	D25	D24
D23	D22	D21	D20	D19	D18	D17	D16
D15	D14	D13	D12	D11	D10	D9	D8
D7	D6	D5	D4	D3	D2	D1	D0

Table 71. TIMESTAMP output register description

D[31:0]	Timestamp output registers: 1LSB = 12.5 μ s
---------	---

The formula below can be used to calculate a better estimation of the actual timestamp resolution:

$$TS_Res = 1 / (80000 + (0.0015 * INTERNAL_FREQ_FINE * 80000))$$

where INTERNAL_FREQ_FINE is the content of INTERNAL_FREQ_FINE (63h).

9.29 **SLOPE_EN (56h)**

Slope enable (r/w)

Table 72. SLOPE_EN register

0 ⁽¹⁾	0 ⁽¹⁾	SLEEP_STATUS_ON_INT	SLOPE_FDS	0 ⁽¹⁾	0 ⁽¹⁾	0 ⁽¹⁾	LIR
------------------	------------------	---------------------	-----------	------------------	------------------	------------------	-----

1. This bit must be set to '0' for the correct operation of the device.

Table 73. SLOPE_EN register description

SLEEP_STATUS_ON_INT	Activity/inactivity interrupt mode configuration. If the INT1_SLEEP_CHANGE or INT2_SLEEP_CHANGE bits are enabled, drives the sleep status or sleep change on the INT pins. Default value: 0 (0: sleep change notification on INT pins; 1: sleep status reported on INT pins)
SLOPE_FDS	HPF or slope filter selection on wake-up and activity/inactivity functions. Default value: 0 (0: Slope filter applied; 1: HPF applied)
LIR	Latched Interrupt. Default value: 0 (0: interrupt request not latched; 1: interrupt request latched)

9.30 INTERRUPTS_EN (58h)

Enables interrupt functions (r/w)

Table 74. INTERRUPTS_EN register

INTERRUPTS_EN_ENABLE	0 ⁽¹⁾	0 ⁽¹⁾	0 ⁽¹⁾	0 ⁽¹⁾	0 ⁽¹⁾	0 ⁽¹⁾	0 ⁽¹⁾
----------------------	------------------	------------------	------------------	------------------	------------------	------------------	------------------

1. This bit must be set to '0' for the correct operation of the device.

Table 75. INTERRUPTS_EN register description

INTERRUPTS_EN_ENABLE	Enables wake-up and activity/inactivity interrupt logic. Default value: 0 (0: interrupt disabled; 1: interrupt enabled)
----------------------	---

9.31 WAKE_UP_THS (5Bh)

Wake-up configuration (r/w)

Table 76. WAKE_UP_THS register

0 ⁽¹⁾	USR_OFF_ON_WU	WK_THS5	WK_THS4	WK_THS3	WK_THS2	WK_THS1	WK_THS0
------------------	---------------	---------	---------	---------	---------	---------	---------

1. This bit must be set to '0' for the correct operation of the device.

Table 77. WAKE_UP_THS register description

USR_OFF_ON_WU	Drives the low-pass filtered data with user offset correction (instead of high-pass filtered data) to the wakeup function.
WK_THS[5:0]	Threshold for wakeup: 1 LSB weight depends on WAKE_THS_W in WAKE_UP_DUR (5Ch). Default value: 000000

9.32 WAKE_UP_DUR (5Ch)

Wakeup and sleep mode functions duration setting register (r/w)

Table 78. WAKE_UP_DUR register

0 ⁽¹⁾	WAKE_DUR1	WAKE_DUR0	WAKE_THS_W	SLEEP_DUR3	SLEEP_DUR2	SLEEP_DUR1	SLEEP_DUR0
------------------	-----------	-----------	------------	------------	------------	------------	------------

1. This bit must be set to '0' for the correct operation of the device.

Table 79. WAKE_UP_DUR register description

WAKE_DUR[1:0]	Wake up duration event. Default: 00 1LSB = 1 ODR_time
WAKE_THS_W	Weight of 1 LSB of wakeup threshold. Default: 0 (0: 1 LSB = FS_XL / (2 ⁶); 1: 1 LSB = FS_XL / (2 ⁸))
SLEEP_DUR[3:0]	Duration to go in sleep mode. Default value: 0000 (this corresponds to 16 ODR) 1 LSB = 512 ODR

9.33 MD1_CFG (5Eh)

Functions routing on INT1 register (r/w)

Table 80. MD1_CFG register

INT1_SLEEP_CHANGE	0 ⁽¹⁾	INT1_WU	0 ⁽¹⁾	0 ⁽¹⁾	0 ⁽¹⁾	0 ⁽¹⁾	0 ⁽¹⁾
-------------------	------------------	---------	------------------	------------------	------------------	------------------	------------------

1. This bit must be set to '0' for the correct operation of the device.

Table 81. MD1_CFG register description

INT1_SLEEP_CHANGE ⁽¹⁾	Routing of activity/inactivity recognition event on INT1. Default: 0 (0: routing of activity/inactivity event on INT1 disabled; 1: routing of activity/inactivity event on INT1 enabled)
INT1_WU	Routing of wakeup event on INT1. Default value: 0 (0: routing of wakeup event on INT1 disabled; 1: routing of wakeup event on INT1 enabled)

1. Activity/Inactivity interrupt mode (sleep change or sleep status) depends on the SLEEP_STATUS_ON_INT bit in SLOPE_EN (56h) register.

9.34 MD2_CFG (5Fh)

Functions routing on INT2 register (r/w)

Table 82. MD2_CFG register

INT2_SLEEP_CHANGE	0 ⁽¹⁾	INT2_WU	0 ⁽¹⁾	0 ⁽¹⁾	0 ⁽¹⁾	0 ⁽¹⁾	INT2_TIMESTAMP
-------------------	------------------	---------	------------------	------------------	------------------	------------------	----------------

1. This bit must be set to '0' for the correct operation of the device.

INT2_SLEEP_CHANGE ⁽¹⁾	Routing of activity/inactivity recognition event on INT2. Default: 0 (0: routing of activity/inactivity event on INT2 disabled; 1: routing of activity/inactivity event on INT2 enabled)
INT2_WU	Routing of wakeup event on INT2. Default value: 0 (0: routing of wakeup event on INT2 disabled; 1: routing of wake-up event on INT2 enabled)
INT2_TIMESTAMP	Enables routing on INT2 pin of the alert for timestamp overflow within 6.4 ms

1. Activity/Inactivity interrupt mode (sleep change or sleep status) depends on the SLEEP_STATUS_ON_INT bit in SLOPE_EN (56h) register.

9.35 INTERNAL_FREQ_FINE (63h)

Internal frequency register (r)

Table 83. INTERNAL_FREQ_FINE register

FREQ_FINE7	FREQ_FINE6	FREQ_FINE5	FREQ_FINE4	FREQ_FINE3	FREQ_FINE2	FREQ_FINE1	FREQ_FINE0
------------	------------	------------	------------	------------	------------	------------	------------

Table 84. INTERNAL_FREQ_FINE register description

FREQ_FINE[7:0]	Difference in percentage of the effective ODR (and timestamp rate) with respect to the typical. Step: 0.15%. 8-bit format, 2's complement.
----------------	--

The formula below can be used to calculate a better estimation of the actual ODR:

$$\text{ODR_Actual} = (26667 + ((0.0015 * \text{INTERNAL_FREQ_FINE}) * 26667))$$

9.36 X_OFS_USR (73h)

Accelerometer X-axis user offset correction (r/w). The offset value set in the X_OFS_USR offset register is internally subtracted from the acceleration value measured on the X-axis.

Table 85. X_OFS_USR register

X_OFS_USR_7	X_OFS_USR_6	X_OFS_USR_5	X_OFS_USR_4	X_OFS_USR_3	X_OFS_USR_2	X_OFS_USR_1	X_OFS_USR_0
-------------	-------------	-------------	-------------	-------------	-------------	-------------	-------------

Table 86. X_OFS_USR register description

X_OFS_USR[7:0]	Accelerometer X-axis user offset correction expressed in two's complement, weight depends on USR_OFF_W in CTRL6_C (15h). The value must be in the range [-127 127].
----------------	---

9.37 Y_OFS_USR (74h)

Accelerometer Y-axis user offset correction (r/w). The offset value set in the Y_OFS_USR offset register is internally subtracted from the acceleration value measured on the Y-axis.

Table 87. Y_OFS_USR register

Y_OFS_USR_7	Y_OFS_USR_6	Y_OFS_USR_5	Y_OFS_USR_4	Y_OFS_USR_3	Y_OFS_USR_2	Y_OFS_USR_1	Y_OFS_USR_0
-------------	-------------	-------------	-------------	-------------	-------------	-------------	-------------

Table 88. Y_OFS_USR register description

Y_OFS_USR[7:0]	Accelerometer Y-axis user offset calibration expressed in 2's complement, weight depends on USR_OFF_W in CTRL6_C (15h). The value must be in the range [-127, +127].
----------------	--

9.38 Z_OFS_USR (75h)

Accelerometer Z-axis user offset correction (r/w). The offset value set in the Z_OFS_USR offset register is internally subtracted from the acceleration value measured on the Z-axis.

Table 89. Z_OFS_USR register

Z_OFS_USR_7	Z_OFS_USR_6	Z_OFS_USR_5	Z_OFS_USR_4	Z_OFS_USR_3	Z_OFS_USR_2	Z_OFS_USR_1	Z_OFS_USR_0
-------------	-------------	-------------	-------------	-------------	-------------	-------------	-------------

Table 90. Z_OFS_USR register description

Z_OFS_USR_[7:0]	Accelerometer Z-axis user offset calibration expressed in 2's complement, weight depends on USR_OFF_W in CTRL6_C (15h). The value must be in the range [-127, +127].
-----------------	--

9.39 FIFO_DATA_OUT_TAG (78h)

FIFO tag register (r)

Table 91. FIFO_DATA_OUT_TAG register

TAG_SENSOR_4	TAG_SENSOR_3	TAG_SENSOR_2	TAG_SENSOR_1	TAG_SENSOR_0	TAG_CNT_1	TAG_CNT_0	TAG_PARITY
--------------	--------------	--------------	--------------	--------------	-----------	-----------	------------

Table 92. FIFO_DATA_OUT_TAG register description

TAG_SENSOR_[4:0]	FIFO tag: identifies the sensor in: FIFO_DATA_OUT_X_L (79h) and FIFO_DATA_OUT_X_H (7Ah), FIFO_DATA_OUT_Y_L (7Bh) and FIFO_DATA_OUT_Y_H (7Ch), and FIFO_DATA_OUT_Z_L (7Dh) and FIFO_DATA_OUT_Z_H (7Eh) For details, refer to Table 93.
TAG_CNT_[1:0]	2-bit counter which identifies sensor time slot
TAG_PARITY	Parity check of TAG content

Table 93. FIFO tag

TAG_SENSOR_[4:0]	Sensor name
0x02	Accelerometer
0x03	Temperature
0x04	Timestamp

9.40 FIFO_DATA_OUT_X_L (79h) and FIFO_DATA_OUT_X_H (7Ah)

FIFO data output X (r)

Table 94. FIFO_DATA_OUT_X_H and FIFO_DATA_OUT_X_L registers

D15	D14	D13	D12	D11	D10	D9	D8
D7	D6	D5	D4	D3	D2	D1	D0

Table 95. FIFO_DATA_OUT_X_H and FIFO_DATA_OUT_X_L register description

D[15:0]	FIFO X-axis output
---------	--------------------

9.41 FIFO_DATA_OUT_Y_L (7Bh) and FIFO_DATA_OUT_Y_H (7Ch)

FIFO data output Y (r)

Table 96. FIFO_DATA_OUT_Y_H and FIFO_DATA_OUT_Y_L registers

D15	D14	D13	D12	D11	D10	D9	D8
D7	D6	D5	D4	D3	D2	D1	D0

Table 97. FIFO_DATA_OUT_Y_H and FIFO_DATA_OUT_Y_L register description

D[15:0]	FIFO Y-axis output
---------	--------------------

9.42 FIFO_DATA_OUT_Z_L (7Dh) and FIFO_DATA_OUT_Z_H (7Eh)

FIFO data output Z (r)

Table 98. FIFO_DATA_OUT_Z_H and FIFO_DATA_OUT_Z_L registers

D15	D14	D13	D12	D11	D10	D9	D8
D7	D6	D5	D4	D3	D2	D1	D0

Table 99. FIFO_DATA_OUT_Z_H and FIFO_DATA_OUT_Z_L register description

D[15:0]	FIFO Z-axis output
---------	--------------------

10 Soldering information

The LGA package is compliant with the ECOPACK, RoHS and "Green" standard.
It is qualified for soldering heat resistance according to JEDEC J-STD-020.
Land pattern and soldering recommendations are available at www.st.com/mems.

11 Package information

In order to meet environmental requirements, ST offers these devices in different grades of **ECOPACK** packages, depending on their level of environmental compliance. ECOPACK specifications, grade definitions and product status are available at: www.st.com. ECOPACK is an ST trademark.

11.1 LGA-14L package information

Figure 22. LGA-14L 2.5 x 3.0 x 0.83 mm³ (typ) package outline and mechanical data

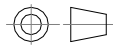
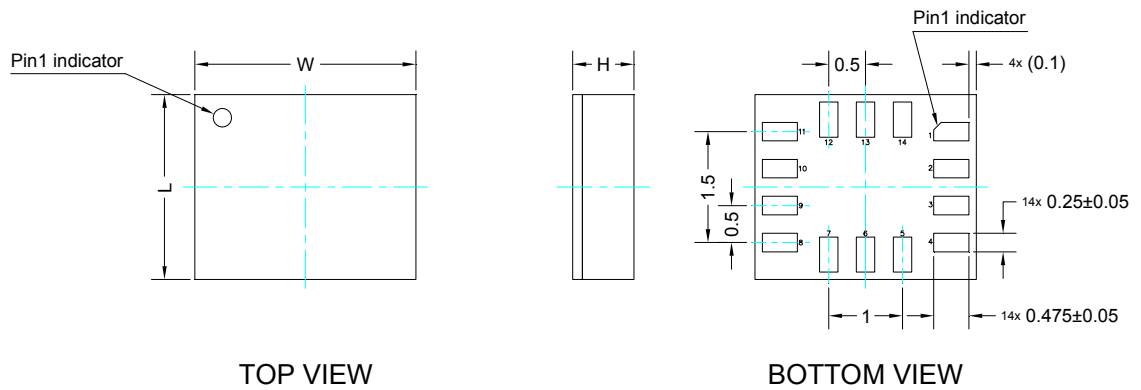

Dimensions are in millimeter unless otherwise specified
General tolerance is +/-0.1mm unless otherwise specified

OUTER DIMENSIONS

ITEM	DIMENSION [mm]	TOLERANCE [mm]
Length [L]	2.50	±0.1
Width [W]	3.00	±0.1
Height [H]	0.86	MAX

DM00249496_1

11.2 LGA-14 packing information

Figure 23. Carrier tape information for LGA-14 package

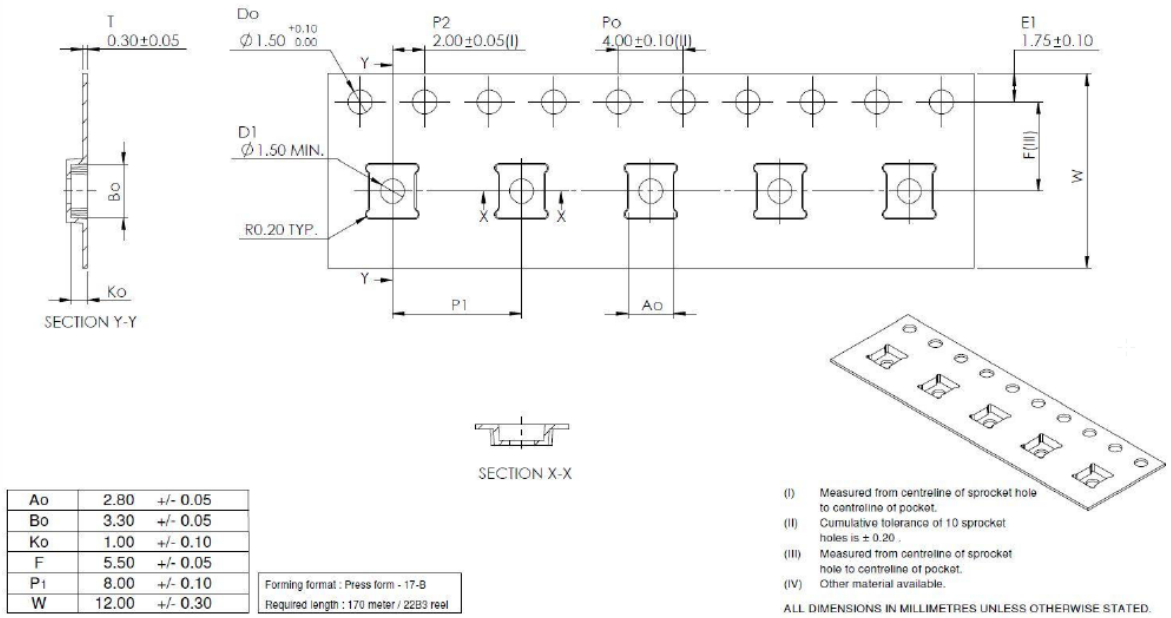

Figure 24. LGA-14 package orientation in carrier tape

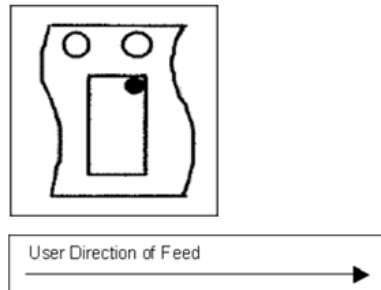

Figure 25. Reel information for carrier tape of LGA-14 package

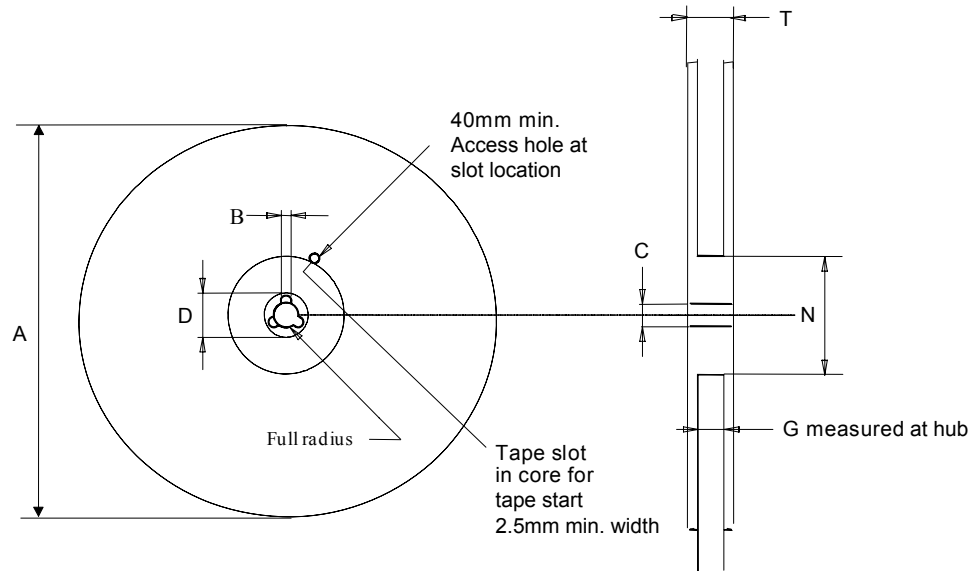

Table 100. Reel dimensions for carrier tape of LGA-14 package

Reel dimensions (mm)	
A (max)	330
B (min)	1.5
C	13 ±0.25
D (min)	20.2
N (min)	60
G	12.4 +2/-0
T (max)	18.4

Revision history

Table 101. Document revision history

Date	Version	Changes
29-Jan-2020	3	First public release
20-Feb-2020	4	Updated CTRL8_XL (17h) Updated SLOPE_EN (56h) Added INTERRUPTS_EN (58h) Updated Table 92. FIFO tag Minor textual changes
21-Jul-2020	5	Updated Section 3.3.7 FIFO reading procedure Updated description of dataready_pulsed bit in COUNTER_BDR_REG1 (0Bh) Updated TIMESTAMP0 (40h), TIMESTAMP1 (41h), TIMESTAMP2 (42h), and TIMESTAMP3 (43h)
13-Aug-2020	6	Added Section 3 Digital interface

Contents

1	Pin description	3
1.1	Default pin configuration	4
2	Module specifications	5
2.1	Mechanical characteristics	5
2.2	Electrical characteristics	6
2.3	Temperature sensor characteristics	7
2.4	Communication interface characteristics	8
2.4.1	SPI - serial peripheral interface	8
2.5	Absolute maximum ratings	9
2.6	Terminology	10
2.6.1	Sensitivity	10
2.6.2	Zero-g level	10
3	Digital interface	11
3.1	SPI interface	11
3.2	SPI bus interface	12
3.2.1	SPI read	13
3.2.2	SPI write	14
3.2.3	SPI read in 3-wire mode	14
4	Functionality	15
4.1	Operating modes	15
4.2	Block diagrams	16
4.3	FIFO	17
4.3.1	Bypass mode	17
4.3.2	FIFO mode	17
4.3.3	Continuous mode	18
4.3.4	Continuous-to-FIFO mode	18
4.3.5	Bypass-to-Continuous mode	18
4.3.6	Bypass-to-FIFO mode	18
4.3.7	FIFO reading procedure	18
5	Frequency response	19

6	Typical performance characteristics	21
6.1	Frequency response measurements	21
6.2	Sensitivity change versus temperature	23
6.3	ODR change versus temperature	23
7	Application hints	24
7.1	IIS3DWB electrical connections	24
7.2	Measuring the actual ODR	25
8	Register mapping	26
9	Register description	28
9.1	PIN_CTRL (02h)	28
9.2	FIFO_CTRL1 (07h)	28
9.3	FIFO_CTRL2 (08h)	28
9.4	FIFO_CTRL3 (09h)	29
9.5	FIFO_CTRL4 (0Ah)	29
9.6	COUNTER_BDR_REG1 (0Bh)	30
9.7	COUNTER_BDR_REG2 (0Ch)	30
9.8	INT1_CTRL (0Dh)	31
9.9	INT2_CTRL (0Eh)	31
9.10	WHO_AM_I (0Fh)	31
9.11	CTRL1_XL (10h)	32
9.12	CTRL3_C (12h)	33
9.13	CTRL4_C (13h)	34
9.14	CTRL5_C (14h)	34
9.15	CTRL6_C (15h)	35
9.16	CTRL7_C (16h)	35
9.17	CTRL8_XL (17h)	36
9.18	CTRL10_C (19h)	37
9.19	ALL_INT_SRC (1Ah)	37
9.20	WAKE_UP_SRC (1Bh)	38
9.21	STATUS_REG (1Eh)	38

9.22	OUT_TEMP_L (20h), OUT_TEMP_H (21h)	39
9.23	OUTX_L_A (28h) and OUTX_H_A (29h)	39
9.24	OUTY_L_A (2Ah) and OUTY_H_A (2Bh)	40
9.25	OUTZ_L_A (2Ch) and OUTZ_H_A (2Dh)	40
9.26	FIFO_STATUS1 (3Ah)	41
9.27	FIFO_STATUS2 (3Bh)	41
9.28	TIMESTAMP0 (40h), TIMESTAMP1 (41h), TIMESTAMP2 (42h), and TIMESTAMP3 (43h)	42
9.29	SLOPE_EN (56h)	42
9.30	INTERRUPTS_EN (58h)	43
9.31	WAKE_UP_THS (5Bh)	43
9.32	WAKE_UP_DUR (5Ch)	43
9.33	MD1_CFG (5Eh)	44
9.34	MD2_CFG (5Fh)	44
9.35	INTERNAL_FREQ_FINE (63h)	45
9.36	X_OFS_USR (73h)	45
9.37	Y_OFS_USR (74h)	45
9.38	Z_OFS_USR (75h)	46
9.39	FIFO_DATA_OUT_TAG (78h)	46
9.40	FIFO_DATA_OUT_X_L (79h) and FIFO_DATA_OUT_X_H (7Ah)	47
9.41	FIFO_DATA_OUT_Y_L (7Bh) and FIFO_DATA_OUT_Y_H (7Ch)	47
9.42	FIFO_DATA_OUT_Z_L (7Dh) and FIFO_DATA_OUT_Z_H (7Eh)	47
10	Soldering information	48
11	Package information	49
11.1	LGA-14L package information	49
11.2	LGA-14 packing information	50
	Revision history	52
	Contents	53
	List of tables	56
	List of figures	58

List of tables

Table 1.	Pin description	3
Table 2.	Default pin status	4
Table 3.	Mechanical characteristics	5
Table 4.	Electrical characteristics	6
Table 5.	SPI slave timing values	8
Table 6.	Absolute maximum ratings	9
Table 7.	Serial interface pin description	11
Table 8.	Register address map	26
Table 9.	PIN_CTRL register	28
Table 10.	PIN_CTRL register description	28
Table 11.	FIFO_CTRL1 register	28
Table 12.	FIFO_CTRL1 register description	28
Table 13.	FIFO_CTRL2 register	28
Table 14.	FIFO_CTRL2 register description	28
Table 15.	FIFO_CTRL3 register	29
Table 16.	FIFO_CTRL3 register description	29
Table 17.	FIFO_CTRL4 register	29
Table 18.	FIFO_CTRL4 register description	29
Table 19.	COUNTER_BDR_REG1 register	30
Table 20.	COUNTER_BDR_REG1 register description	30
Table 21.	COUNTER_BDR_REG2 register	30
Table 22.	COUNTER_BDR_REG2 register description	30
Table 23.	INT1_CTRL register	31
Table 24.	INT1_CTRL register description	31
Table 25.	INT2_CTRL register	31
Table 26.	INT2_CTRL register description	31
Table 27.	WHO_AM_I register	31
Table 28.	CTRL1_XL register	32
Table 29.	CTRL1_XL register description	32
Table 30.	Accelerometer full-scale selection	32
Table 31.	CTRL3_C register	33
Table 32.	CTRL3_C register description	33
Table 33.	CTRL4_C register	34
Table 34.	CTRL4_C register description	34
Table 35.	CTRL5_C register	34
Table 36.	CTRL5_C register description	34
Table 37.	Linear acceleration sensor self-test mode selection	34
Table 38.	CTRL6_C register	35
Table 39.	CTRL6_C register description	35
Table 40.	Accelerometer active axis	35
Table 41.	CTRL7_C register	35
Table 42.	CTRL7_C register description	35
Table 43.	CTRL8_XL register	36
Table 44.	CTRL8_XL register description	36
Table 45.	Accelerometer bandwidth configurations	36
Table 46.	CTRL10_C register	37
Table 47.	CTRL10_C register description	37
Table 48.	ALL_INT_SRC register	37
Table 49.	ALL_INT_SRC register description	37
Table 50.	WAKE_UP_SRC register	38
Table 51.	WAKE_UP_SRC register description	38
Table 52.	STATUS_REG register	38

Table 53.	STATUS_REG register description	38
Table 54.	OUT_TEMP_L register	39
Table 55.	OUT_TEMP_H register	39
Table 56.	OUT_TEMP register description	39
Table 57.	OUTX_L_A register	39
Table 58.	OUTX_H_A register	39
Table 59.	OUTX_H_A register description	39
Table 60.	OUTY_L_A register	40
Table 61.	OUTY_H_A register	40
Table 62.	OUTY_H_A register description	40
Table 63.	OUTZ_L_A register	40
Table 64.	OUTZ_H_A register	40
Table 65.	OUTZ_H_A register description	40
Table 66.	FIFO_STATUS1 register	41
Table 67.	FIFO_STATUS1 register description	41
Table 68.	FIFO_STATUS2 register	41
Table 69.	FIFO_STATUS2 register description	41
Table 70.	TIMESTAMP output registers	42
Table 71.	TIMESTAMP output register description	42
Table 72.	SLOPE_EN register	42
Table 73.	SLOPE_EN register description	42
Table 74.	INTERRUPTS_EN register	43
Table 75.	INTERRUPTS_EN register description	43
Table 76.	WAKE_UP_THS register	43
Table 77.	WAKE_UP_THS register description	43
Table 78.	WAKE_UP_DUR register	43
Table 79.	WAKE_UP_DUR register description	43
Table 80.	MD1_CFG register	44
Table 81.	MD1_CFG register description	44
Table 82.	MD2_CFG register	44
Table 83.	INTERNAL_FREQ_FINE register	45
Table 84.	INTERNAL_FREQ_FINE register description	45
Table 85.	X_OFS_USR register	45
Table 86.	X_OFS_USR register description	45
Table 87.	Y_OFS_USR register	45
Table 88.	Y_OFS_USR register description	45
Table 89.	Z_OFS_USR register	46
Table 90.	Z_OFS_USR register description	46
Table 91.	FIFO_DATA_OUT_TAG register	46
Table 92.	FIFO_DATA_OUT_TAG register description	46
Table 93.	FIFO tag	46
Table 94.	FIFO_DATA_OUT_X_H and FIFO_DATA_OUT_X_L registers	47
Table 95.	FIFO_DATA_OUT_X_H and FIFO_DATA_OUT_X_L register description	47
Table 96.	FIFO_DATA_OUT_Y_H and FIFO_DATA_OUT_Y_L registers	47
Table 97.	FIFO_DATA_OUT_Y_H and FIFO_DATA_OUT_Y_L register description	47
Table 98.	FIFO_DATA_OUT_Z_H and FIFO_DATA_OUT_Z_L registers	47
Table 99.	FIFO_DATA_OUT_Z_H and FIFO_DATA_OUT_Z_L register description	47
Table 100.	Reel dimensions for carrier tape of LGA-14 package	51
Table 101.	Document revision history	52

List of figures

Figure 1.	Pin connections	3
Figure 2.	SPI slave timing diagram	8
Figure 3.	Read and write protocol (in mode 3)	12
Figure 4.	SPI read protocol (in mode 3)	13
Figure 5.	Multiple byte SPI read protocol (2-byte example) (in mode 3)	13
Figure 6.	SPI write protocol (in mode 3)	14
Figure 7.	Multiple byte SPI write protocol (2-byte example) (in mode 3)	14
Figure 8.	SPI read protocol in 3-wire mode (in mode 3)	14
Figure 9.	Accelerometer architecture	16
Figure 10.	Accelerometer composite filter	16
Figure 11.	Filtering chain	19
Figure 12.	Frequency response at the output of LPF1 filter	19
Figure 13.	Frequency response with LPF2 enabled	20
Figure 14.	Frequency response with HPF enabled	20
Figure 15.	Frequency response - X-axis	21
Figure 16.	Frequency response - Y-axis	21
Figure 17.	Frequency response - Z-axis	22
Figure 18.	Sensitivity change versus temperature	23
Figure 19.	ODR change versus temperature	23
Figure 20.	IIS3DWB electrical connections	24
Figure 21.	Accurately measuring ODR	25
Figure 22.	LGA-14L 2.5 x 3.0 x 0.83 mm ³ (typ) package outline and mechanical data	49
Figure 23.	Carrier tape information for LGA-14 package	50
Figure 24.	LGA-14 package orientation in carrier tape	50
Figure 25.	Reel information for carrier tape of LGA-14 package	51

IMPORTANT NOTICE – PLEASE READ CAREFULLY

STMicroelectronics NV and its subsidiaries (“ST”) reserve the right to make changes, corrections, enhancements, modifications, and improvements to ST products and/or to this document at any time without notice. Purchasers should obtain the latest relevant information on ST products before placing orders. ST products are sold pursuant to ST’s terms and conditions of sale in place at the time of order acknowledgement.

Purchasers are solely responsible for the choice, selection, and use of ST products and ST assumes no liability for application assistance or the design of Purchasers’ products.

No license, express or implied, to any intellectual property right is granted by ST herein.

Resale of ST products with provisions different from the information set forth herein shall void any warranty granted by ST for such product.

ST and the ST logo are trademarks of ST. For additional information about ST trademarks, please refer to www.st.com/trademarks. All other product or service names are the property of their respective owners.

Information in this document supersedes and replaces information previously supplied in any prior versions of this document.

© 2020 STMicroelectronics – All rights reserved

Mouser Electronics

Authorized Distributor

Click to View Pricing, Inventory, Delivery & Lifecycle Information:

[STMicroelectronics:](#)

[IIS3DWBTR](#)