

## 10 MHz, 12V Op Amps

### Features:

- Input Offset Voltage:  $\pm 1$  mV (typical)
- Quiescent Current: 2 mA (typical)
- Common Mode Rejection Ratio: 98 dB (typical)
- Power Supply Rejection Ratio: 94 dB (typical)
- Rail-to-Rail Output
- Supply Voltage Range:
  - Single-Supply Operation: 3.5V to 12V
  - Dual-Supply Operation:  $\pm 1.75$ V to  $\pm 6$ V
- Gain Bandwidth Product: 10 MHz (typical)
- Slew Rate: 10 V/ $\mu$ s (typical)
- Unity Gain Stable
- Extended Temperature Range:  $-40^{\circ}\text{C}$  to  $+125^{\circ}\text{C}$
- No Phase Reversal

### Applications:

- Automotive Power Electronics
- Industrial Control Equipment
- Battery Powered Systems
- Medical Diagnostic Instruments

### Design Aids:

- SPICE Macro Models
- FilterLab<sup>®</sup> Software
- MAPS (Microchip Advanced Part Selector)
- Analog Demonstration and Evaluation Boards
- Application Notes

### Typical Application



### Description:

Microchip's MCP6H91/2/4 family of operational amplifiers (op amps) has a wide supply voltage range of 3.5V to 12V and rail-to-rail output operation. This family is unity gain stable and has a gain bandwidth product of 10 MHz (typical). These devices operate with a single-supply voltage as high as 12V, while only drawing 2 mA/amplifier (typical) of quiescent current.

The MCP6H91/2/4 family is offered in single (MCP6H91), dual (MCP6H92) and quad (MCP6H94) configurations. All devices are fully specified in extended temperature range from  $-40^{\circ}\text{C}$  to  $+125^{\circ}\text{C}$ .

### Package Types



# MCP6H91/2/4

---

NOTES:

## 1.0 ELECTRICAL CHARACTERISTICS

### 1.1 Absolute Maximum Ratings †

$V_{DD} - V_{SS}$ .....	13.2V
Current at Input Pins.....	±2 mA
Analog Inputs ( $V_{IN+}$ , $V_{IN-}$ )††.....	$V_{SS} - 1.0V$ to $V_{DD} + 1.0V$
All Other Inputs and Outputs .....	$V_{SS} - 0.3V$ to $V_{DD} + 0.3V$
Difference Input Voltage.....	$V_{DD} - V_{SS}$
Output Short-Circuit Current.....	continuous
Current at Output and Supply Pins .....	±65 mA
Storage Temperature.....	-65°C to +150°C
Maximum Junction Temperature ( $T_J$ ).....	+150°C
ESD protection on all pins (HBM; MM).....	≥ 2 kV; 200V

† **Notice:** Stresses above those listed under “Absolute Maximum Ratings” may cause permanent damage to the device. This is a stress rating only and functional operation of the device at those or any other conditions above those indicated in the operational listings of this specification is not implied. Exposure to maximum rating conditions for extended periods may affect device reliability.

†† See [Section 4.1.2, Input Voltage Limits](#).

## DC ELECTRICAL SPECIFICATIONS

**Electrical Characteristics:** Unless otherwise indicated,  $V_{DD} = +3.5V$  to  $+12V$ ,  $V_{SS} = GND$ ,  $T_A = +25^\circ C$ ,  $V_{CM} = V_{DD}/2 - 1.4V$ ,  $V_{OUT} \approx V_{DD}/2$ ,  $V_L = V_{DD}/2$  and  $R_L = 10\text{ k}\Omega$  to  $V_L$ . (Refer to [Figure 1-1](#)).

Parameters	Sym.	Min.	Typ.	Max.	Units	Conditions
<b>Input Offset</b>						
Input Offset Voltage	$V_{OS}$	-4	±1	+4	mV	
Input Offset Drift with Temperature	$\Delta V_{OS}/\Delta T_A$	—	±2.5	—	$\mu V/^\circ C$	$T_A = -40^\circ C$ to $+125^\circ C$
Power Supply Rejection Ratio	PSRR	75	94	—	dB	
<b>Input Bias Current and Impedance</b>						
Input Bias Current	$I_B$	—	10	—	pA	
		—	400	—	pA	$T_A = +85^\circ C$
		—	9	25	nA	$T_A = +125^\circ C$
Input Offset Current	$I_{OS}$	—	±1	—	pA	
Common Mode Input Impedance	$Z_{CM}$	—	$10^{13}  6$	—	$\Omega  pF$	
Differential Input Impedance	$Z_{DIFF}$	—	$10^{13}  6$	—	$\Omega  pF$	
<b>Common Mode</b>						
Common Mode Input Voltage Range	$V_{CMR}$	$V_{SS} - 0.3$	—	$V_{DD} - 2.5$	V	
Common Mode Rejection Ratio	CMRR	75	91	—	dB	$V_{CM} = -0.3V$ to $1.0V$ , $V_{DD} = 3.5V$
		80	97	—	dB	$V_{CM} = -0.3V$ to $2.5V$ , $V_{DD} = 5V$
		80	98	—	dB	$V_{CM} = -0.3V$ to $9.5V$ , $V_{DD} = 12V$
<b>Open-Loop Gain</b>						
DC Open-Loop Gain (Large Signal)	$A_{OL}$	95	115	—	dB	$0.2V < V_{OUT} < (V_{DD} - 0.2V)$

# MCP6H91/2/4

## DC ELECTRICAL SPECIFICATIONS (CONTINUED)

**Electrical Characteristics:** Unless otherwise indicated,  $V_{DD} = +3.5V$  to  $+12V$ ,  $V_{SS} = GND$ ,  $T_A = +25^\circ C$ ,  $V_{CM} = V_{DD}/2 - 1.4V$ ,  $V_{OUT} \approx V_{DD}/2$ ,  $V_L = V_{DD}/2$  and  $R_L = 10\text{ k}\Omega$  to  $V_L$ . (Refer to [Figure 1-1](#)).

Parameters	Sym.	Min.	Typ.	Max.	Units	Conditions
<b>Output</b>						
High-Level Output Voltage	$V_{OH}$	3.490	3.495	—	V	$V_{DD} = 3.5V$ 0.5V input overdrive
		4.985	4.993	—	V	$V_{DD} = 5V$ 0.5V input overdrive
		11.970	11.980	—	V	$V_{DD} = 12V$ 0.5V input overdrive
Low-Level Output Voltage	$V_{OL}$	—	0.005	0.010	V	$V_{DD} = 3.5V$ 0.5 V input overdrive
		—	0.007	0.015	V	$V_{DD} = 5V$ 0.5 V input overdrive
		—	0.020	0.030	V	$V_{DD} = 12V$ 0.5 V input overdrive
Output Short-Circuit Current	$I_{SC}$	—	$\pm 35$	—	mA	$V_{DD} = 3.5V$
		—	$\pm 41$	—	mA	$V_{DD} = 5V$
		—	$\pm 41$	—	mA	$V_{DD} = 12V$
<b>Power Supply</b>						
Supply Voltage	$V_{DD}$	3.5	—	12	V	Single-Supply operation
		$\pm 1.75$	—	$\pm 6$	V	Dual-Supply operation
Quiescent Current per Amplifier	$I_Q$	—	2	2.8	mA	$I_O = 0$ , $V_{CM} = V_{DD}/4$

## AC ELECTRICAL SPECIFICATIONS

**Electrical Characteristics:** Unless otherwise indicated,  $T_A = +25^\circ C$ ,  $V_{DD} = +3.5V$  to  $+12V$ ,  $V_{SS} = GND$ ,  $V_{CM} = V_{DD}/2 - 1.4V$ ,  $V_{OUT} \approx V_{DD}/2$ ,  $V_L = V_{DD}/2$ ,  $R_L = 10\text{ k}\Omega$  to  $V_L$  and  $C_L = 60\text{ pF}$ . (Refer to [Figure 1-1](#)).

Parameters	Sym.	Min.	Typ.	Max.	Units	Conditions
<b>AC Response</b>						
Gain Bandwidth Product	GBWP	—	10	—	MHz	
Phase Margin	PM	—	60	—	$^\circ C$	$G = +1V/V$
Slew Rate	SR	—	10	—	V/ $\mu s$	
<b>Noise</b>						
Input Noise Voltage	$E_{ni}$	—	10	—	$\mu V_{p-p}$	$f = 0.1\text{ Hz to }10\text{ Hz}$
Input Noise Voltage Density	$E_{ni}$	—	23	—	nV/ $\sqrt{Hz}$	$f = 1\text{ kHz}$
		—	12	—	nV/ $\sqrt{Hz}$	$f = 10\text{ kHz}$
Input Noise Current Density	$i_{ni}$	—	1.9	—	fA/ $\sqrt{Hz}$	$f = 1\text{ kHz}$

## TEMPERATURE SPECIFICATIONS

Electrical Characteristics: Unless otherwise indicated, $V_{DD} = +3.5V$ to $+12V$ and $V_{SS} = GND$ .						
Parameters	Sym.	Min.	Typ.	Max.	Units	Conditions
<b>Temperature Ranges</b>						
Operating Temperature Range	$T_A$	-40	—	+125	°C	<b>Note 1</b>
Storage Temperature Range	$T_A$	-65	—	+150	°C	
<b>Thermal Package Resistances</b>						
Thermal Resistance, 8L-2x3 TDFN	$\theta_{JA}$	—	52.5	—	°C/W	
Thermal Resistance, 8L-SOIC	$\theta_{JA}$	—	149.5	—	°C/W	
Thermal Resistance, 14L-SOIC	$\theta_{JA}$	—	95.3	—	°C/W	
Thermal Resistance, 14L-TSSOP	$\theta_{JA}$	—	100	—	°C/W	

**Note 1:** The internal junction temperature ( $T_J$ ) must not exceed the absolute maximum specification of  $+150^\circ\text{C}$ .

### 1.2 Test Circuits

The circuit used for most DC and AC tests is shown in [Figure 1-1](#). This circuit can independently set  $V_{CM}$  and  $V_{OUT}$  (refer to [Equation 1-1](#)). Note that  $V_{CM}$  is not the circuit's Common mode voltage ( $(V_P + V_M)/2$ ), and that  $V_{OST}$  includes  $V_{OS}$  plus the effects (on the input offset error,  $V_{OST}$ ) of temperature, CMRR, PSRR and  $A_{OL}$ .

#### EQUATION 1-1:

$$G_{DM} = R_F/R_G$$

$$V_{CM} = (V_P + V_{DD}/2)/2$$

$$V_{OST} = V_{IN-} - V_{IN+}$$

$$V_{OUT} = (V_{DD}/2) + (V_P - V_M) + V_{OST} \cdot (1 + G_{DM})$$

Where:

$$G_{DM} = \text{Differential Mode Gain} \quad (V/V)$$

$$V_{CM} = \text{Op Amp's Common Mode Input Voltage} \quad (V)$$

$$V_{OST} = \text{Op Amp's Total Input Offset Voltage} \quad (mV)$$



**FIGURE 1-1:** AC and DC Test Circuit for Most Specifications.

# MCP6H91/2/4

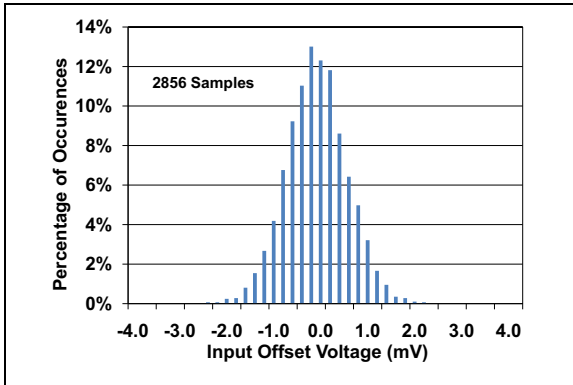
---

NOTES:

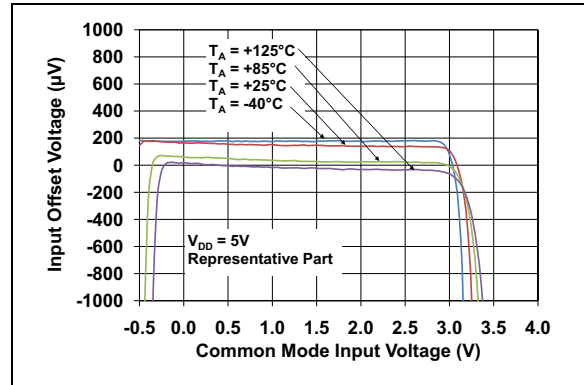
## 2.0 TYPICAL PERFORMANCE CURVES

**Note:** The graphs and tables provided following this note are a statistical summary based on a limited number of samples and are provided for informational purposes only. The performance characteristics listed herein are not tested or guaranteed. In some graphs or tables, the data presented may be outside the specified operating range (e.g., outside specified power supply range) and therefore outside the warranted range.

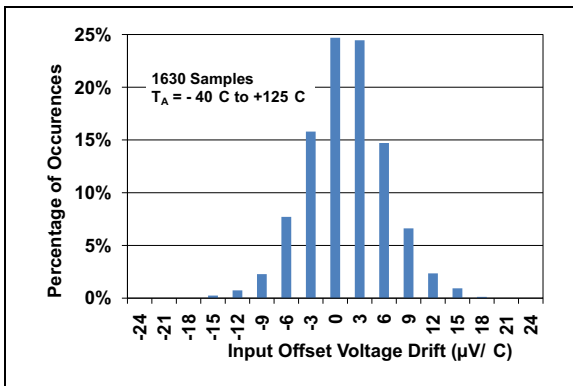
**Note:** Unless otherwise indicated,  $T_A = +25^\circ\text{C}$ ,  $V_{DD} = +3.5\text{V}$  to  $+12\text{V}$ ,  $V_{SS} = \text{GND}$ ,  $V_{CM} = V_{DD}/2 - 1.4\text{V}$ ,  $V_{OUT} \approx V_{DD}/2$ ,  $V_L = V_{DD}/2$ ,  $R_L = 10\text{ k}\Omega$  to  $V_L$  and  $C_L = 60\text{ pF}$ .



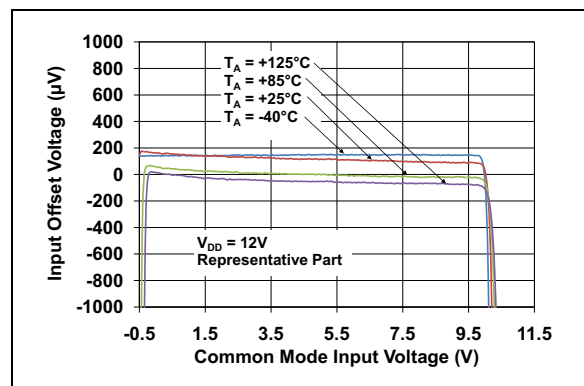
**FIGURE 2-1:** Input Offset Voltage.



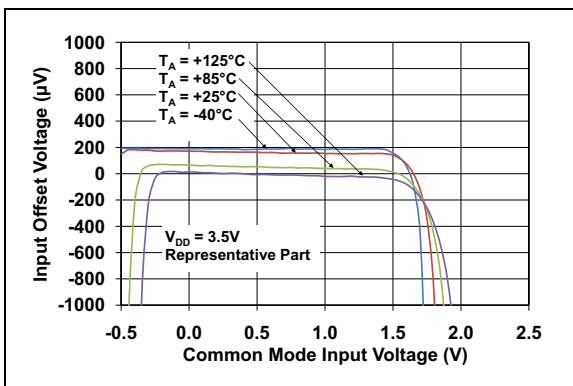
**FIGURE 2-4:** Input Offset Voltage vs. Common Mode Input Voltage.



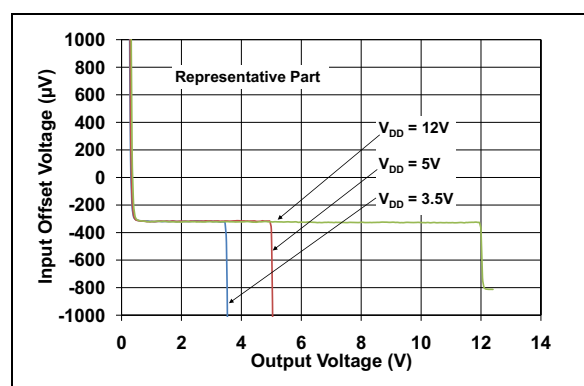
**FIGURE 2-2:** Input Offset Voltage Drift.



**FIGURE 2-5:** Input Offset Voltage vs. Common Mode Input Voltage.



**FIGURE 2-3:** Input Offset Voltage vs. Common Mode Input Voltage.



**FIGURE 2-6:** Input Offset Voltage vs. Output Voltage.

# MCP6H91/2/4

**Note:** Unless otherwise indicated,  $T_A = +25^\circ\text{C}$ ,  $V_{DD} = +3.5\text{V}$  to  $+12\text{V}$ ,  $V_{SS} = \text{GND}$ ,  $V_{CM} = V_{DD}/2 - 1.4\text{V}$ ,  $V_{OUT} \approx V_{DD}/2$ ,  $V_L = V_{DD}/2$ ,  $R_L = 10\text{ k}\Omega$  to  $V_L$  and  $C_L = 60\text{ pF}$ .



**FIGURE 2-7:** Input Offset Voltage vs. Power Supply Voltage.



**FIGURE 2-10:** CMRR, PSRR vs. Frequency.



**FIGURE 2-8:** Input Noise Voltage Density vs. Frequency.



**FIGURE 2-11:** CMRR, PSRR vs. Ambient Temperature.



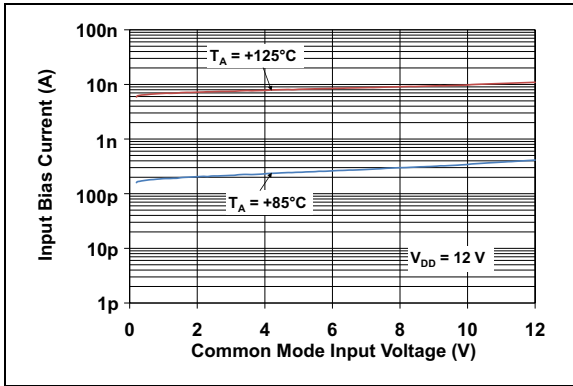
**FIGURE 2-9:** Input Noise Voltage Density vs. Common Mode Input Voltage.



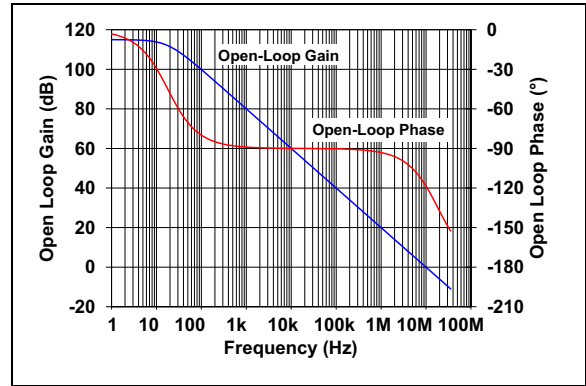
**FIGURE 2-12:** Input Bias, Offset Currents vs. Ambient Temperature.



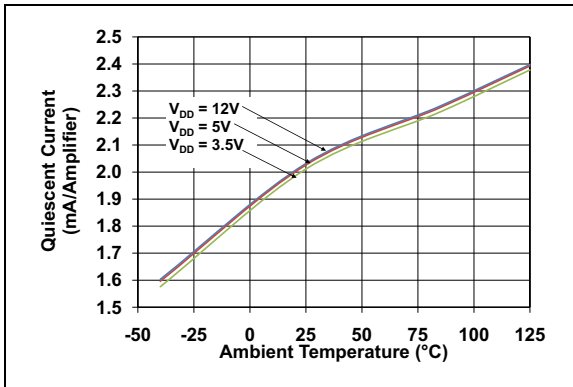
**Note:** Unless otherwise indicated,  $T_A = +25^\circ\text{C}$ ,  $V_{DD} = +3.5\text{V to } +12\text{V}$ ,  $V_{SS} = \text{GND}$ ,  $V_{CM} = V_{DD}/2 - 1.4\text{V}$ ,  $V_{OUT} \approx V_{DD}/2$ ,  $V_L = V_{DD}/2$ ,  $R_L = 10\text{ k}\Omega$  to  $V_L$  and  $C_L = 60\text{ pF}$ .



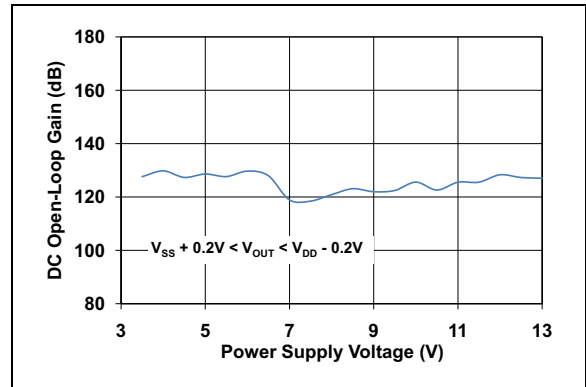
**FIGURE 2-13:** Input Bias Current vs. Common Mode Input Voltage.



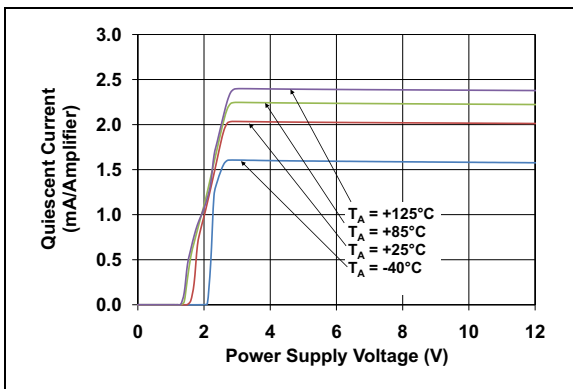
**FIGURE 2-16:** Open-Loop Gain, Phase vs. Frequency.



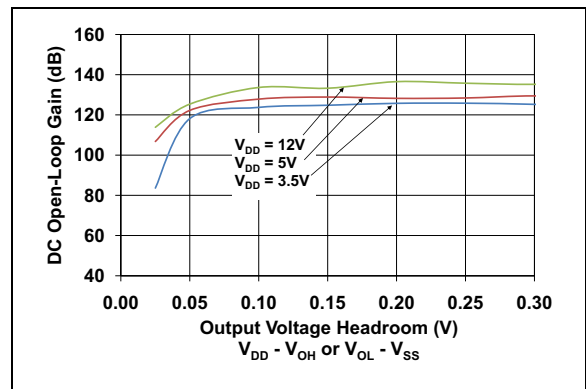
**FIGURE 2-14:** Quiescent Current vs. Ambient Temperature.



**FIGURE 2-17:** DC Open-Loop Gain vs. Power Supply Voltage.



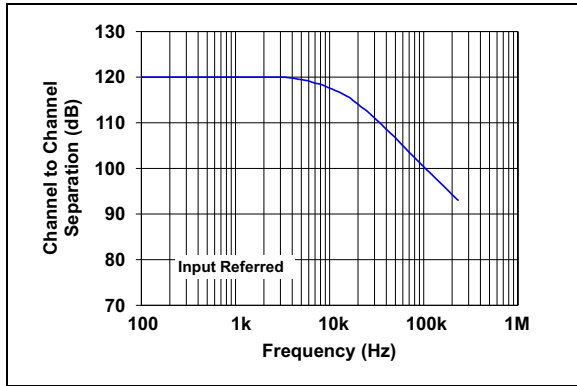
**FIGURE 2-15:** Quiescent Current vs. Power Supply Voltage.



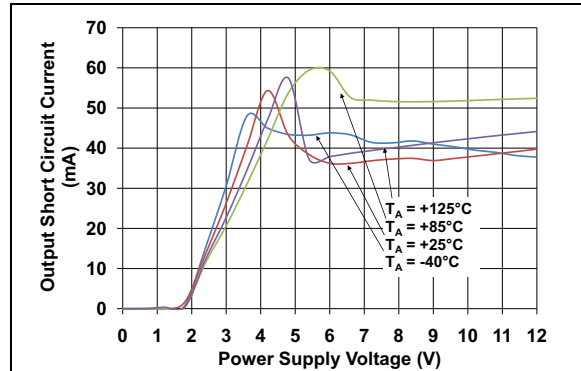
**FIGURE 2-18:** DC Open-Loop Gain vs. Output Voltage Headroom.

# MCP6H91/2/4

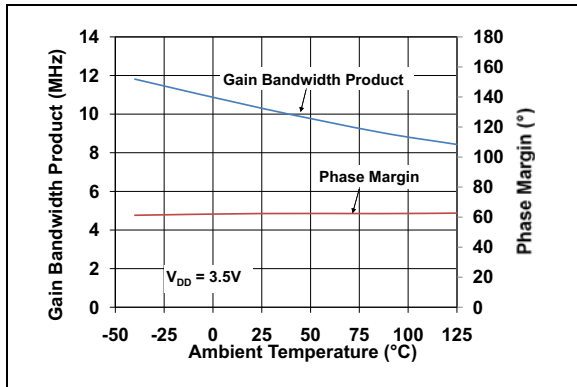
**Note:** Unless otherwise indicated,  $T_A = +25^\circ\text{C}$ ,  $V_{DD} = +3.5\text{V}$  to  $+12\text{V}$ ,  $V_{SS} = \text{GND}$ ,  $V_{CM} = V_{DD}/2 - 1.4\text{V}$ ,  $V_{OUT} \approx V_{DD}/2$ ,  $V_L = V_{DD}/2$ ,  $R_L = 10\text{ k}\Omega$  to  $V_L$  and  $C_L = 60\text{ pF}$ .



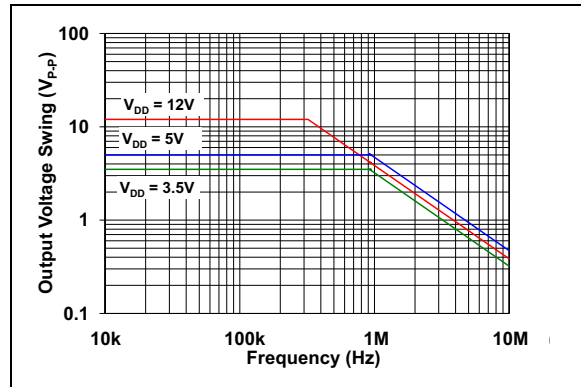
**FIGURE 2-19:** Channel-to-Channel Separation vs. Frequency (MCP6H92 only).



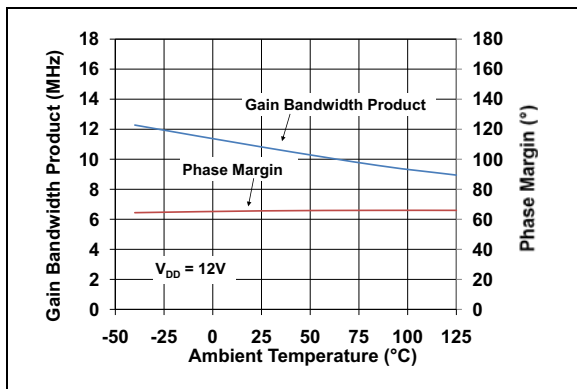
**FIGURE 2-22:** Output Short Circuit Current vs. Power Supply Voltage.



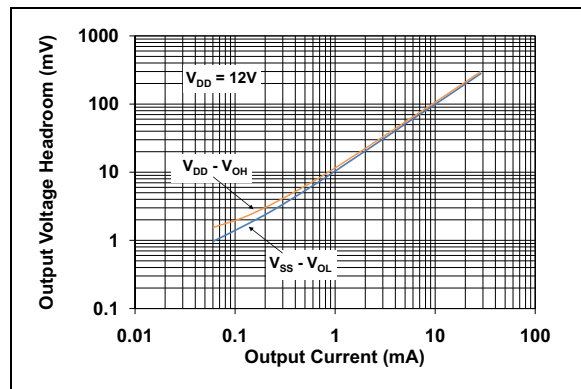
**FIGURE 2-20:** Gain Bandwidth Product, Phase Margin vs. Ambient Temperature.



**FIGURE 2-23:** Output Voltage Swing vs. Frequency.

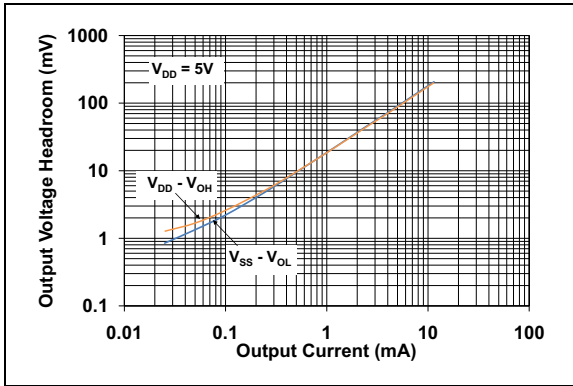


**FIGURE 2-21:** Gain Bandwidth Product, Phase Margin vs. Ambient Temperature.

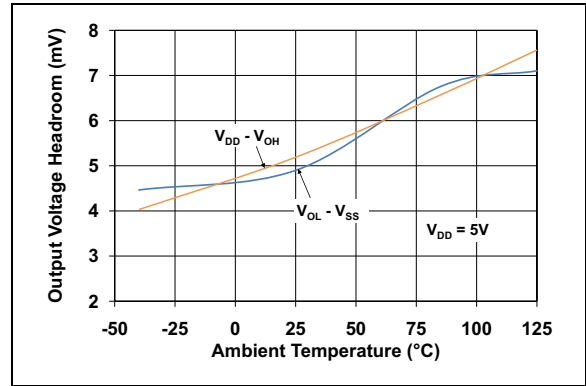


**FIGURE 2-24:** Output Voltage Headroom vs. Output Current.

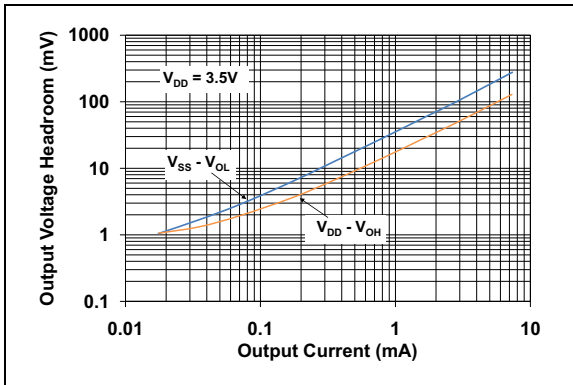
**Note:** Unless otherwise indicated,  $T_A = +25^\circ\text{C}$ ,  $V_{DD} = +3.5\text{V to } +12\text{V}$ ,  $V_{SS} = \text{GND}$ ,  $V_{CM} = V_{DD}/2 - 1.4\text{V}$ ,  $V_{OUT} \approx V_{DD}/2$ ,  $V_L = V_{DD}/2$ ,  $R_L = 10\text{ k}\Omega$  to  $V_L$  and  $C_L = 60\text{ pF}$ .



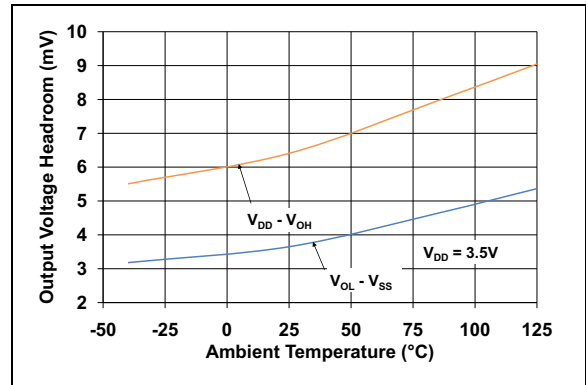
**FIGURE 2-25:** Output Voltage Headroom vs. Output Current.



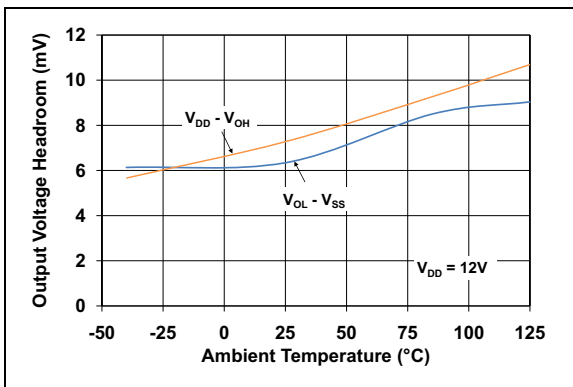
**FIGURE 2-28:** Output Voltage Headroom vs. Ambient Temperature.



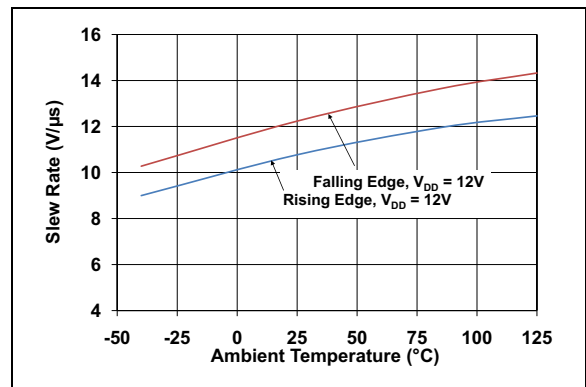
**FIGURE 2-26:** Output Voltage Headroom vs. Output Current.



**FIGURE 2-29:** Output Voltage Headroom vs. Ambient Temperature.



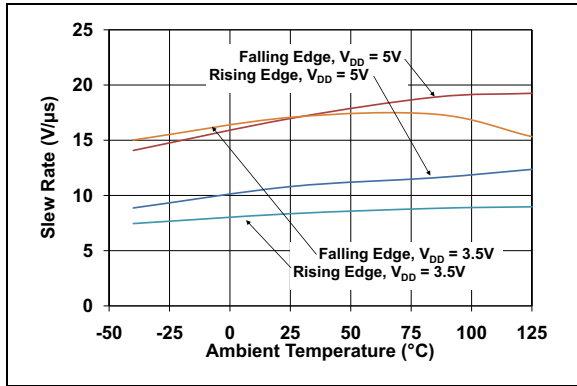
**FIGURE 2-27:** Output Voltage Headroom vs. Ambient Temperature.



**FIGURE 2-30:** Slew Rate vs. Ambient Temperature.

# MCP6H91/2/4

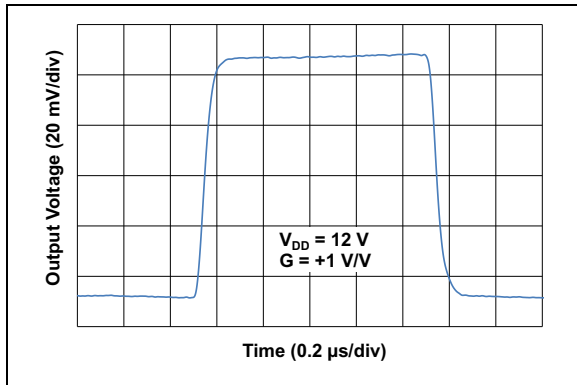
**Note:** Unless otherwise indicated,  $T_A = +25^\circ\text{C}$ ,  $V_{DD} = +3.5\text{ V to }+12\text{ V}$ ,  $V_{SS} = \text{GND}$ ,  $V_{CM} = V_{DD}/2 - 1.4\text{V}$ ,  $V_{OUT} \approx V_{DD}/2$ ,  $V_L = V_{DD}/2$ ,  $R_L = 10\text{ k}\Omega$  to  $V_L$  and  $C_L = 60\text{ pF}$ .



**FIGURE 2-31:** Slew Rate vs. Ambient Temperature.



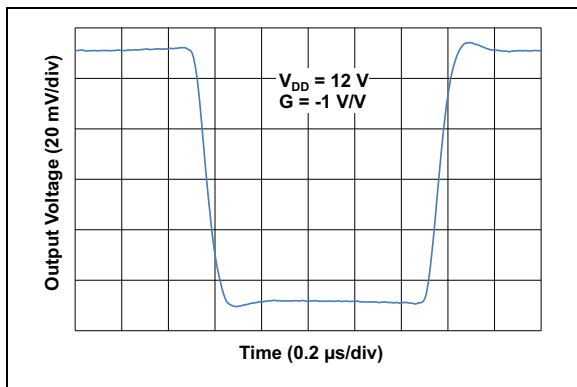
**FIGURE 2-34:** Large Signal Non-Inverting Pulse Response.



**FIGURE 2-32:** Small Signal Non-Inverting Pulse Response.



**FIGURE 2-35:** Large Signal Inverting Pulse Response.



**FIGURE 2-33:** Small Signal Inverting Pulse Response.



**FIGURE 2-36:** The MCP6H91/2/4 Shows No Phase Reversal.

**Note:** Unless otherwise indicated,  $T_A = +25^\circ\text{C}$ ,  $V_{DD} = +3.5\text{ V to }+12\text{ V}$ ,  $V_{SS} = \text{GND}$ ,  $V_{CM} = V_{DD}/2 - 1.4\text{V}$ ,  $V_{OUT} \approx V_{DD}/2$ ,  $V_L = V_{DD}/2$ ,  $R_L = 10\text{ k}\Omega$  to  $V_L$  and  $C_L = 60\text{ pF}$ .



**FIGURE 2-37:** Closed Loop Output Impedance vs. Frequency.



**FIGURE 2-38:** Measured Input Current vs. Input Voltage (below  $V_{SS}$ ).

# MCP6H91/2/4

---

NOTES:

## 3.0 PIN DESCRIPTIONS

Descriptions of the pins are listed in [Table 3-1](#).

**TABLE 3-1: PIN FUNCTION TABLE**

MCP6H91		MCP6H92		MCP6H94	Symbol	Description
SOIC	2x3 TDFN	SOIC	2x3 TDFN	SOIC, TSSOP		
6	6	1	1	1	$V_{OUT}, V_{OUTA}$	Analog Output (op amp A)
2	2	2	2	2	$V_{IN-}, V_{INA-}$	Inverting Input (op amp A)
3	3	3	3	3	$V_{IN+}, V_{INA+}$	Non-inverting Input (op amp A)
7	7	8	8	4	$V_{DD}$	Positive Power Supply
—	—	5	5	5	$V_{INB+}$	Non-inverting Input (op amp B)
—	—	6	6	6	$V_{INB-}$	Inverting Input (op amp B)
—	—	7	7	7	$V_{OUTB}$	Analog Output (op amp B)
—	—	—	—	8	$V_{OUTC}$	Analog Output (op amp C)
—	—	—	—	9	$V_{INC-}$	Inverting Input (op amp C)
—	—	—	—	10	$V_{INC+}$	Non-inverting Input (op amp C)
4	4	4	4	11	$V_{SS}$	Negative Power Supply
—	—	—	—	12	$V_{IND+}$	Non-inverting Input (op amp D)
—	—	—	—	13	$V_{IND-}$	Inverting Input (op amp D)
—	—	—	—	14	$V_{OUTD}$	Analog Output (op amp D)
1, 5, 8	1, 5, 8	—	—	—	NC	No Internal Connection
—	9	—	9	—	EP	Exposed Thermal Pad (EP); must be connected to $V_{SS}$ .

### 3.1 Analog Outputs

The output pins are low-impedance voltage sources.

### 3.2 Analog Inputs

The non-inverting and inverting inputs are high-impedance CMOS inputs with low bias currents.

### 3.3 Power Supply Pins

The positive power supply ( $V_{DD}$ ) is 3.5V to 12V higher than the negative power supply ( $V_{SS}$ ). For normal operation, the other pins are at voltages between  $V_{SS}$  and  $V_{DD}$ .

Typically, these parts can be used in single-supply operation or dual-supply operation. Also,  $V_{DD}$  will need bypass capacitors.

### 3.4 Exposed Thermal Pad (EP)

There is an internal electrical connection between the Exposed Thermal Pad (EP) and the  $V_{SS}$  pin; they must be connected to the same potential on the Printed Circuit Board (PCB).

This pad can be connected to a PCB ground plane to provide a larger heat sink. This improves the package thermal resistance ( $\theta_{JA}$ ).

# MCP6H91/2/4

---

NOTES:



## 4.0 APPLICATION INFORMATION

The MCP6H91/2/4 family of op amps is manufactured using Microchip's state-of-the-art CMOS process and is specifically designed for low-power, high-precision applications.

### 4.1 Inputs

#### 4.1.1 PHASE REVERSAL

The MCP6H91/2/4 op amps are designed to prevent phase reversal when the input pins exceed the supply voltages. Figure 2-36 shows the input voltage exceeding the supply voltage without any phase reversal.

#### 4.1.2 INPUT VOLTAGE LIMITS

In order to prevent damage and/or improper operation of these amplifiers, the circuit must limit the voltages at the input pins (see Section 1.1 "Absolute Maximum Ratings †").

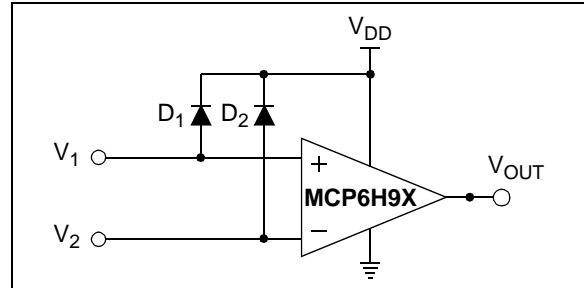
The ESD protection on the inputs can be depicted as shown in Figure 4-1. This structure was chosen to protect the input transistors against many (but not all) overvoltage conditions, and to minimize the input bias current ( $I_B$ ).



**FIGURE 4-1:** Simplified Analog Input ESD Structures.

The input ESD diodes clamp the inputs when they try to go more than one diode drop below  $V_{SS}$ . They also clamp any voltages that go well above  $V_{DD}$ . Their breakdown voltage is high enough to allow normal operation, but not low enough to protect against slow overvoltage (beyond  $V_{DD}$ ) events. Very fast ESD events (that meet the specification) are limited so that damage does not occur.

In some applications, it may be necessary to prevent excessive voltages from reaching the op amp inputs; Figure 4-2 shows one approach to protecting these inputs.



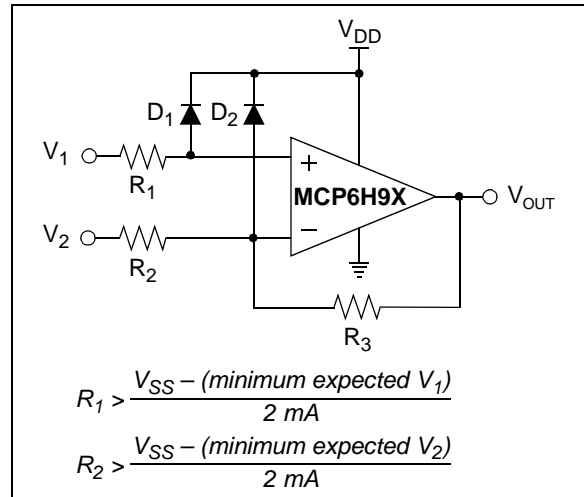
**FIGURE 4-2:** Protecting the Analog Inputs.

A significant amount of current can flow out of the inputs when the Common mode voltage ( $V_{CM}$ ) is below ground ( $V_{SS}$ ), as shown in Figure 2-38.

#### 4.1.3 INPUT CURRENT LIMITS

In order to prevent damage and/or improper operation of these amplifiers, the circuit must limit the currents into the input pins (see Section 1.1 "Absolute Maximum Ratings †").

Figure 4-3 shows one approach to protecting these inputs. The resistors  $R_1$  and  $R_2$  limit the possible currents in or out of the input pins (and the ESD diodes,  $D_1$  and  $D_2$ ). The diode currents will go through either  $V_{DD}$  or  $V_{SS}$ .



**FIGURE 4-3:** Protecting the Analog Inputs.

#### 4.1.4 NORMAL OPERATION

The inputs of the MCP6H91/2/4 op amps connect to a differential PMOS input stage. It operates at a low Common mode input voltage ( $V_{CM}$ ), including ground. With this topology, the device operates with a  $V_{CM}$  up to  $V_{DD} - 2.5V$  and  $0.3V$  below  $V_{SS}$  (refer to Figures 2-3 through 2-5). The input offset voltage is measured at  $V_{CM} = V_{SS} - 0.3V$  and  $V_{DD} - 2.5V$  to ensure proper operation.

For a unity gain buffer,  $V_{IN}$  must be maintained below  $V_{DD} - 2.5V$  for correct operation.

# MCP6H91/2/4

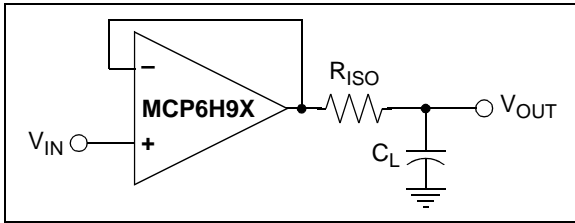
## 4.2 Rail-to-Rail Output

The output voltage range of the MCP6H91/2/4 op amps is 0.020V (typical) and 11.980V (typical) when  $R_L = 10\text{ k}\Omega$  is connected to  $V_{DD}/2$  and  $V_{DD} = 12\text{V}$ . Refer to Figures 2-24 through 2-29 for more information.

## 4.3 Capacitive Loads

Driving large capacitive loads can cause stability problems for voltage feedback op amps. As the load capacitance increases, the feedback loop's phase margin decreases and the closed-loop bandwidth is reduced. This produces gain peaking in the frequency response, with overshoot and ringing in the step response. While a unity-gain buffer ( $G = +1\text{V/V}$ ) is the most sensitive to capacitive loads, all gains show the same general behavior.

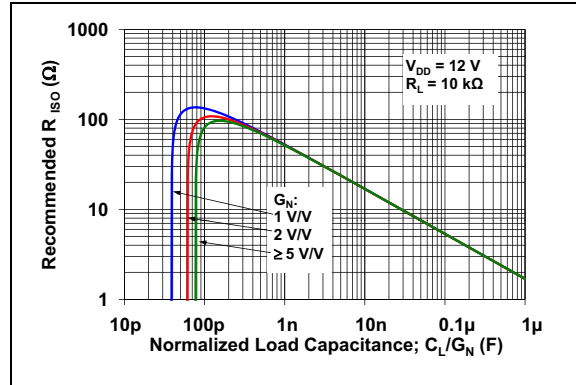
When driving large capacitive loads with these op amps (e.g.,  $> 100\text{ pF}$  when  $G = +1\text{V/V}$ ), a small series resistor at the output ( $R_{ISO}$  in Figure 4-4) improves the feedback loop's phase margin (stability) by making the output load resistive at higher frequencies. The bandwidth will generally be lower than the bandwidth with no capacitance load.



**FIGURE 4-4:** Output Resistor,  $R_{ISO}$  Stabilizes Large Capacitive Loads.

Figure 4-5 gives the recommended  $R_{ISO}$  values for different capacitive loads and gains. The x-axis is the normalized load capacitance ( $C_L/G_N$ ), where  $G_N$  is the circuit's noise gain. For non-inverting gains,  $G_N$  and the Signal Gain are equal. For inverting gains,  $G_N$  is  $1 + |\text{Signal Gain}|$  (e.g.,  $-1\text{V/V}$  gives  $G_N = +2\text{V/V}$ ).

After selecting  $R_{ISO}$  for your circuit, double check the resulting frequency response peaking and step response overshoot. Modify  $R_{ISO}$ 's value until the response is reasonable. Bench evaluation and simulations with the MCP6H91/2/4 SPICE macro model are helpful.



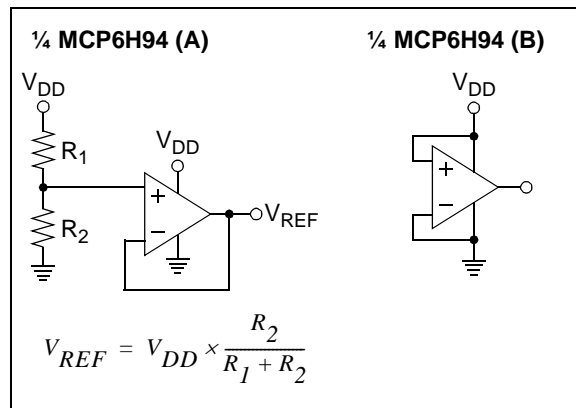
**FIGURE 4-5:** Recommended  $R_{ISO}$  Values for Capacitive Loads.

## 4.4 Supply Bypass

With this family of operational amplifiers, the power supply pin ( $V_{DD}$  for single supply) should have a local bypass capacitor (i.e.,  $0.01\text{ }\mu\text{F}$  to  $0.1\text{ }\mu\text{F}$ ) within 2 mm for good high-frequency performance. It can use a bulk capacitor (i.e.,  $1\text{ }\mu\text{F}$  or larger) within 100 mm to provide large, slow currents. This bulk capacitor can be shared with other analog parts.

## 4.5 Unused Op Amps

An unused op amp in a quad package (MCP6H94) should be configured as shown in Figure 4-6. These circuits prevent the output from toggling and causing crosstalk. Circuit A sets the op amp at its minimum noise gain. The resistor divider produces any desired reference voltage within the output voltage range of the op amp, and the op amp buffers that reference voltage. Circuit B uses the minimum number of components and operates as a comparator, but it may draw more current.

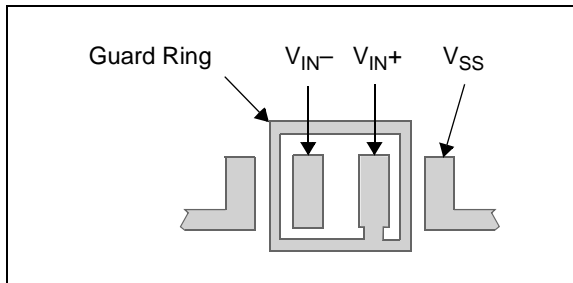


**FIGURE 4-6:** Unused Op Amps.

## 4.6 PCB Surface Leakage

In applications where low input bias current is critical, PCB surface leakage effects need to be considered. Surface leakage is caused by humidity, dust or other contamination on the board. Under low-humidity conditions, a typical resistance between nearby traces is  $10^{12}\Omega$ . A 15V difference would cause 15 pA of current to flow; which is greater than the MCP6H91/2/4 family's bias current at +25°C (10 pA, typical).

The easiest way to reduce surface leakage is to use a guard ring around sensitive pins (or traces). The guard ring is biased at the same voltage as the sensitive pin. An example of this type of layout is shown in Figure 4-7.



**FIGURE 4-7:** Example Guard Ring Layout for Inverting Gain.

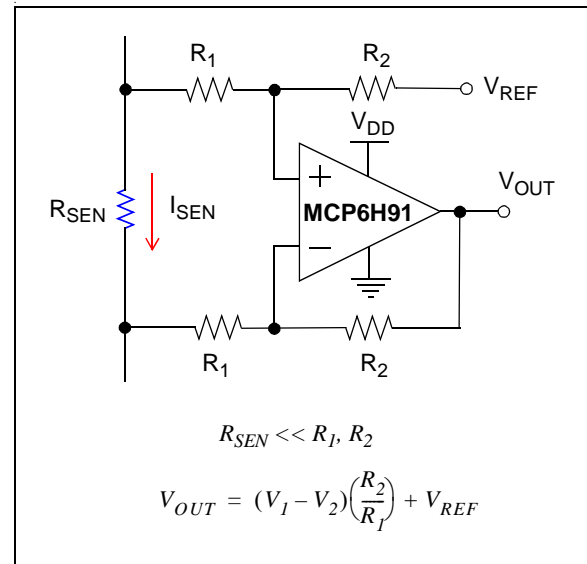
1. Non-inverting Gain and Unity-Gain Buffer:
  - a. Connect the non-inverting pin ( $V_{IN+}$ ) to the input with a wire that does not touch the PCB surface.
  - b. Connect the guard ring to the inverting input pin ( $V_{IN-}$ ). This biases the guard ring to the Common mode input voltage.
2. Inverting Gain and Trans-impedance Gain Amplifiers (convert current to voltage, such as photo detectors):
  - a. Connect the guard ring to the non-inverting input pin ( $V_{IN+}$ ). This biases the guard ring to the same reference voltage as the op amp (e.g.,  $V_{DD}/2$  or ground).
  - b. Connect the inverting pin ( $V_{IN-}$ ) to the input with a wire that does not touch the PCB surface.

## 4.7 Application Circuits

### 4.7.1 DIFFERENCE AMPLIFIER

The MCP6H91/2/4 op amps can be used in current sensing applications. Figure 4-8 shows a resistor ( $R_{SEN}$ ) that converts the sensor current ( $I_{SEN}$ ) to voltage, as well as a difference amplifier that amplifies the voltage across the resistor while rejecting Common mode noise.  $R_1$  and  $R_2$  must be well matched to obtain an acceptable Common Mode Rejection Ratio (CMRR). Moreover,  $R_{SEN}$  should be much smaller than  $R_1$  and  $R_2$  in order to minimize the resistive loading of the source.

To ensure proper operation, the op amp Common mode input voltage must be kept within the allowed range. The reference voltage ( $V_{REF}$ ) is supplied by a low-impedance source. In single-supply applications,  $V_{REF}$  is typically  $V_{DD}/2$ .



**FIGURE 4-8:** High Side Current Sensing Using Difference Amplifier.

# MCP6H91/2/4

## 4.7.2 ACTIVE FULL-WAVE RECTIFIER

The MCP6H91/2/4 family of amplifiers can be used in applications such as an active full-wave rectifier, as shown in Figure 4-9. The amplifier and feedback loops in this active voltage rectifier circuit eliminate the diode drop problem that exists in a passive voltage rectifier. This circuit behaves as a voltage follower (the output follows the input) as long as the input signal is more positive than the reference voltage. If the input signal is more negative than the reference voltage, however, the circuit behaves as an inverting amplifier with a Gain = -1V/V. Therefore, the output voltage will always be above the reference voltage, regardless of the input signal. The reference voltage ( $V_{REF}$ ) is supplied by a low-impedance source. In single-supply applications,  $V_{REF}$  is typically  $V_{DD}/2$ .



FIGURE 4-9: Active Full-Wave Rectifier.

## 4.7.3 LOSSY NON-INVERTING INTEGRATOR

The non-inverting integrator shown in Figure 4-10 is easy to build. It saves one op amp over the typical Miller integrator plus inverting amplifier configuration. The phase accuracy of this integrator depends on the matching of the input and feedback resistor-capacitor time constants.  $R_F$  makes this a lossy integrator (it has finite gain at DC), and makes this integrator stable by itself. To ensure proper operation, the op amp Common mode input voltage must be kept within the allowed range.

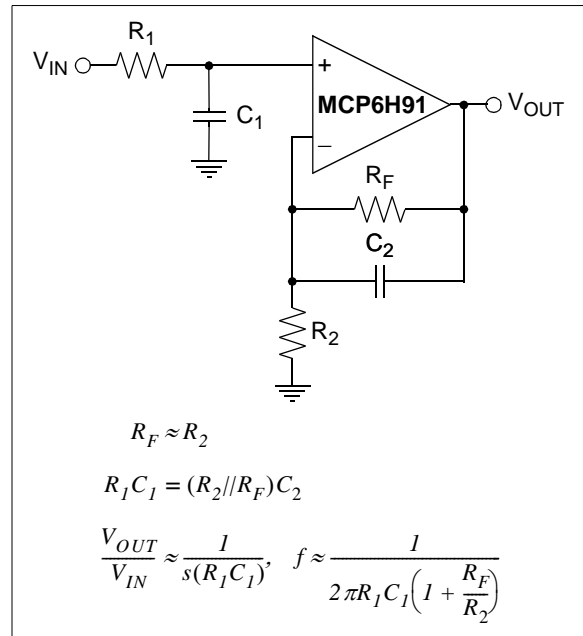


FIGURE 4-10: Non-Inverting Integrator.

## 5.0 DESIGN AIDS

Microchip Technology Inc. provides the basic design tools needed for the MCP6H91/2/4 family of op amps.

### 5.1 SPICE Macro Model

The latest SPICE macro model for the MCP6H91/2/4 op amp is available on the Microchip web site at [www.microchip.com](http://www.microchip.com). The model was written and tested in PSpice, owned by Orcad (Cadence®). For other simulators, translation may be required.

The model covers a wide aspect of the op amp's electrical specifications. Not only does the model cover voltage, current and resistance of the op amp, but it also covers the temperature and noise effects on the behavior of the op amp. The model has not been verified outside the specification range listed in the op amp data sheet. The model behaviors under these conditions cannot be guaranteed to match the actual op amp performance.

Moreover, the model is intended to be an initial design tool. Bench testing is a very important part of any design and cannot be replaced with simulations. Also, simulation results using this macro model need to be validated by comparing them to the data sheet specifications and characteristic curves.

### 5.2 FilterLab® Software

Microchip's FilterLab® software is an innovative software tool that simplifies analog active filter (using op amps) design. Available at no cost from the Microchip web site at [www.microchip.com/filterlab](http://www.microchip.com/filterlab), the FilterLab® design tool provides full schematic diagrams of the filter circuit with component values. It also outputs the filter circuit in SPICE format, which can be used with the macro model to simulate actual filter performance.

### 5.3 MAPS (Microchip Advanced Part Selector)

MAPS is a software tool that helps semiconductor professionals efficiently identify Microchip devices that fit a particular design requirement. Available at no cost from the Microchip web site at [www.microchip.com/maps](http://www.microchip.com/maps), MAPS is an overall selection tool for Microchip's product portfolio that includes analog, memory, MCUs and DSCs. Using this tool, you can define a filter to sort features for a parametric search of devices and export side-by-side technical comparison reports. Helpful links are also provided for data sheets, purchases and sampling of Microchip parts.

## 5.4 Analog Demonstration and Evaluation Boards

Microchip offers a broad spectrum of Analog Demonstration and Evaluation Boards that are designed to help you achieve faster time to market. For a complete listing of these boards and their corresponding user's guides and technical information, visit the Microchip web site: [www.microchip.com/analogtools](http://www.microchip.com/analogtools).

Some boards that are especially useful include:

- MCP6XXX Amplifier Evaluation Board 1
- MCP6XXX Amplifier Evaluation Board 2
- MCP6XXX Amplifier Evaluation Board 3
- MCP6XXX Amplifier Evaluation Board 4
- Active Filter Demo Board Kit
- 5/6-Pin SOT-23 Evaluation Board, part number VSUPEV2
- 8-Pin SOIC/MSOP/TSSOP/DIP Evaluation Board, part number SOIC8EV

## 5.5 Application Notes

The following Microchip analog design note and application notes are available on the Microchip web site at [www.microchip.com/appnotes](http://www.microchip.com/appnotes), and are recommended as supplemental reference resources.

- **ADN003:** "Select the Right Operational Amplifier for your Filtering Circuits", DS21821
- **AN722:** "Operational Amplifier Topologies and DC Specifications", DS00722
- **AN723:** "Operational Amplifier AC Specifications and Applications", DS00723
- **AN884:** "Driving Capacitive Loads With Op Amps", DS00884
- **AN990:** "Analog Sensor Conditioning Circuits – An Overview", DS00990
- **AN1177:** "Op Amp Precision Design: DC Errors", DS01177
- **AN1228:** "Op Amp Precision Design: Random Noise", DS01228
- **AN1297:** "Microchip's Op Amp SPICE Macro Models" DS01297
- **AN1332:** "Current Sensing Circuit Concepts and Fundamentals" DS01332

These application notes and others are listed in:

- "Signal Chain Design Guide", DS21825

# MCP6H91/2/4

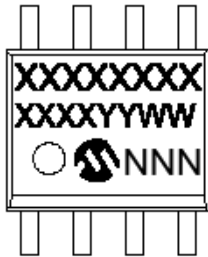
---

NOTES:

## 6.0 PACKAGING INFORMATION

### 6.1 Package Marking Information

8-Lead SOIC (150 mil.) (MCP6H91, MCP6H92)



Example:

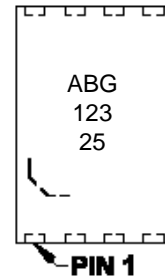


8-Lead 2x3 TDFN (MCP6H91, MCP6H92)

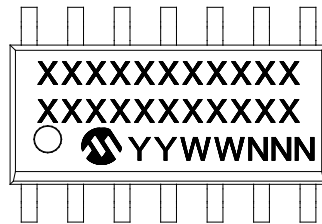


Part Number	Code
MCP6H91T-E/MNY	ABG
MCP6H92T-E/MNY	ABH

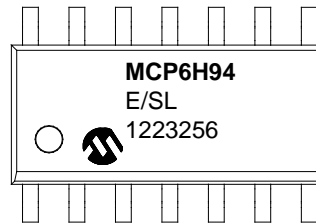
Example:



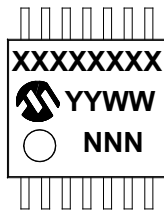
14-Lead SOIC (150 mil) (MCP6H94)



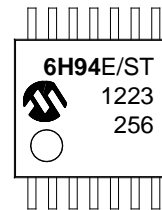
Example:



14-Lead TSSOP (MCP6H94)



Example:



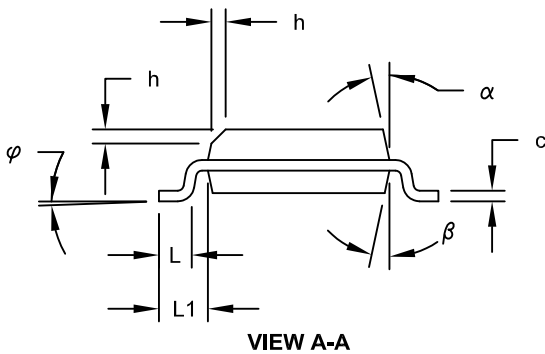
<b>Legend:</b>	XX...X	Customer-specific information
	Y	Year code (last digit of calendar year)
	YY	Year code (last 2 digits of calendar year)
	WW	Week code (week of January 1 is week '01')
	NNN	Alphanumeric traceability code
	(e3)	Pb-free JEDEC designator for Matte Tin (Sn)
	*	This package is Pb-free. The Pb-free JEDEC designator (e3) can be found on the outer packaging for this package.

**Note:** In the event the full Microchip part number cannot be marked on one line, it will be carried over to the next line, thus limiting the number of available characters for customer-specific information.

# MCP6H91/2/4

## 8-Lead Plastic Small Outline (SN) - Narrow, 3.90 mm Body [SOIC]

**Note:** For the most current package drawings, please see the Microchip Packaging Specification located at <http://www.microchip.com/packaging>

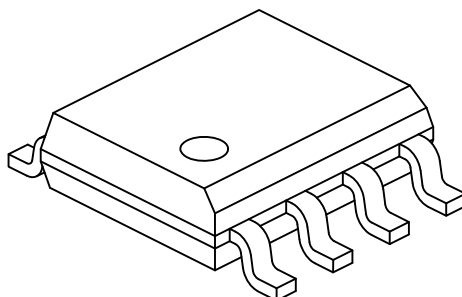


Microchip Technology Drawing No. C04-057C Sheet 1 of 2



## 8-Lead Plastic Small Outline (SN) - Narrow, 3.90 mm Body [SOIC]

**Note:** For the most current package drawings, please see the Microchip Packaging Specification located at <http://www.microchip.com/packaging>



Dimension Limits	Units	MILLIMETERS		
		MIN	NOM	MAX
Number of Pins	N	8		
Pitch	e	1.27 BSC		
Overall Height	A	-	-	1.75
Molded Package Thickness	A2	1.25	-	-
Standoff §	A1	0.10	-	0.25
Overall Width	E	6.00 BSC		
Molded Package Width	E1	3.90 BSC		
Overall Length	D	4.90 BSC		
Chamfer (Optional)	h	0.25	-	0.50
Foot Length	L	0.40	-	1.27
Footprint	L1	1.04 REF		
Foot Angle	$\varphi$	0°	-	8°
Lead Thickness	c	0.17	-	0.25
Lead Width	b	0.31	-	0.51
Mold Draft Angle Top	$\alpha$	5°	-	15°
Mold Draft Angle Bottom	$\beta$	5°	-	15°

**Notes:**

1. Pin 1 visual index feature may vary, but must be located within the hatched area.
2. § Significant Characteristic
3. Dimensions D and E1 do not include mold flash or protrusions. Mold flash or protrusions shall not exceed 0.15mm per side.
4. Dimensioning and tolerancing per ASME Y14.5M

BSC: Basic Dimension. Theoretically exact value shown without tolerances.

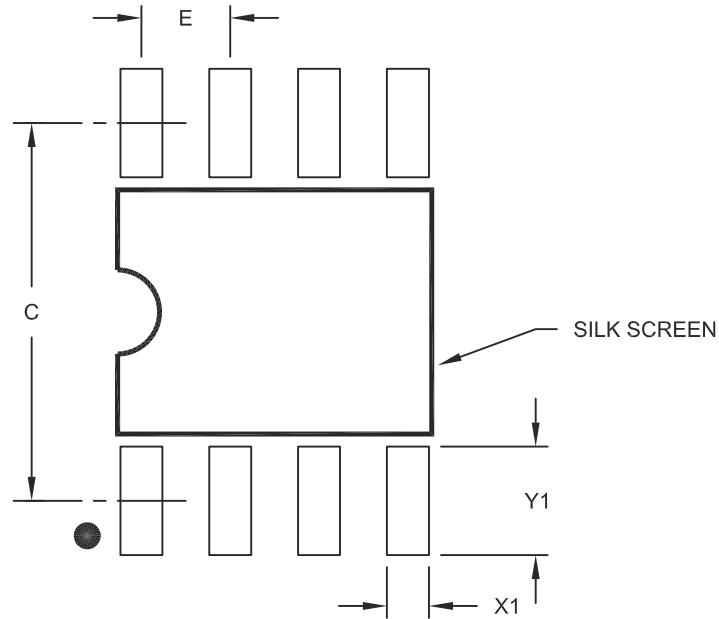
REF: Reference Dimension, usually without tolerance, for information purposes only.

Microchip Technology Drawing No. C04-057C Sheet 2 of 2

# MCP6H91/2/4

## 8-Lead Plastic Small Outline (SN) – Narrow, 3.90 mm Body [SOIC]

**Note:** For the most current package drawings, please see the Microchip Packaging Specification located at <http://www.microchip.com/packaging>



RECOMMENDED LAND PATTERN

		Units	MILLIMETERS		
Dimension Limits			MIN	NOM	MAX
Contact Pitch	E		1.27 BSC		
Contact Pad Spacing	C			5.40	
Contact Pad Width (X8)	X1				0.60
Contact Pad Length (X8)	Y1				1.55

Notes:

1. Dimensioning and tolerancing per ASME Y14.5M

BSC: Basic Dimension. Theoretically exact value shown without tolerances.

Microchip Technology Drawing No. C04-2057A

## 8-Lead Plastic Dual Flat, No Lead Package (MN) – 2x3x0.75mm Body [TDFN]

**Note:** For the most current package drawings, please see the Microchip Packaging Specification located at <http://www.microchip.com/packaging>

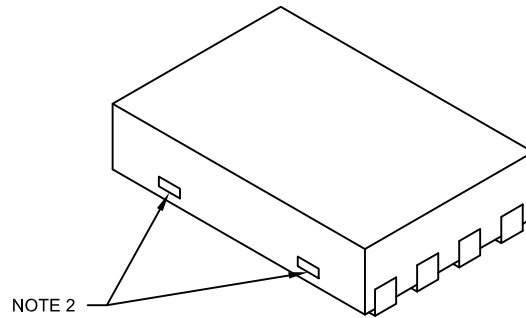


Microchip Technology Drawing No. C04-129C Sheet 1 of 2

# MCP6H91/2/4

## 8-Lead Plastic Dual Flat, No Lead Package (MN) – 2x3x0.75mm Body [TDFN]

**Note:** For the most current package drawings, please see the Microchip Packaging Specification located at <http://www.microchip.com/packaging>



Dimension Limits	Units	MILLIMETERS		
		MIN	NOM	MAX
Number of Pins	N	8		
Pitch	e	0.50 BSC		
Overall Height	A	0.70	0.75	0.80
Standoff	A1	0.00	0.02	0.05
Contact Thickness	A3	0.20 REF		
Overall Length	D	2.00 BSC		
Overall Width	E	3.00 BSC		
Exposed Pad Length	D2	1.20	-	1.60
Exposed Pad Width	E2	1.20	-	1.60
Contact Width	b	0.20	0.25	0.30
Contact Length	L	0.25	0.30	0.45
Contact-to-Exposed Pad	K	0.20	-	-

### Notes:

1. Pin 1 visual index feature may vary, but must be located within the hatched area.
2. Package may have one or more exposed tie bars at ends.
3. Package is saw singulated
4. Dimensioning and tolerancing per ASME Y14.5M

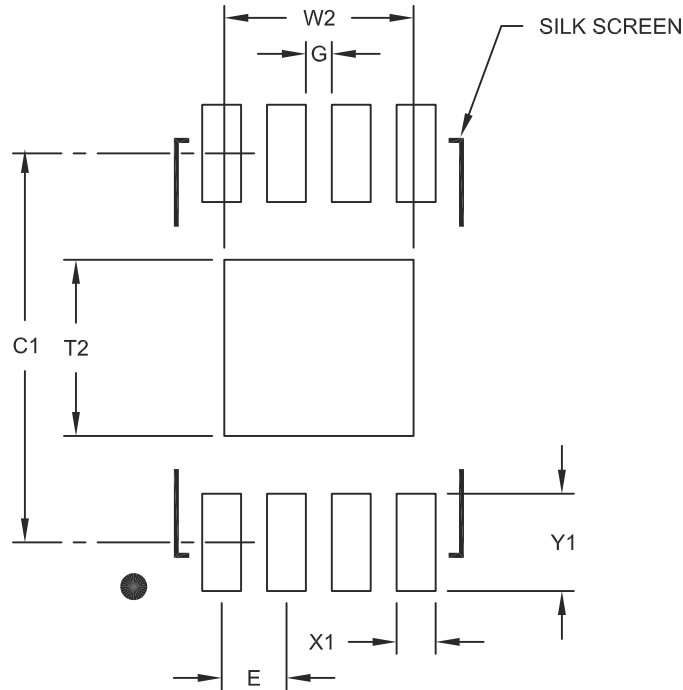
BSC: Basic Dimension. Theoretically exact value shown without tolerances.

REF: Reference Dimension, usually without tolerance, for information purposes only.

Microchip Technology Drawing No. C04-129C Sheet 2 of 2

## 8-Lead Plastic Dual Flat, No Lead Package (MN) – 2x3x0.75 mm Body [TDFN]

**Note:** For the most current package drawings, please see the Microchip Packaging Specification located at <http://www.microchip.com/packaging>



RECOMMENDED LAND PATTERN

Dimension Limits	Units	MILLIMETERS		
		MIN	NOM	MAX
Contact Pitch	E	0.50 BSC		
Optional Center Pad Width	W2			1.46
Optional Center Pad Length	T2			1.36
Contact Pad Spacing	C1		3.00	
Contact Pad Width (X8)	X1			0.30
Contact Pad Length (X8)	Y1			0.75
Distance Between Pads	G	0.20		

Notes:

1. Dimensioning and tolerancing per ASME Y14.5M

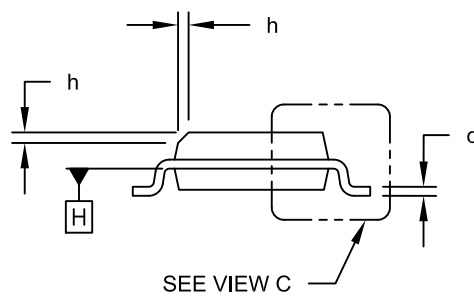
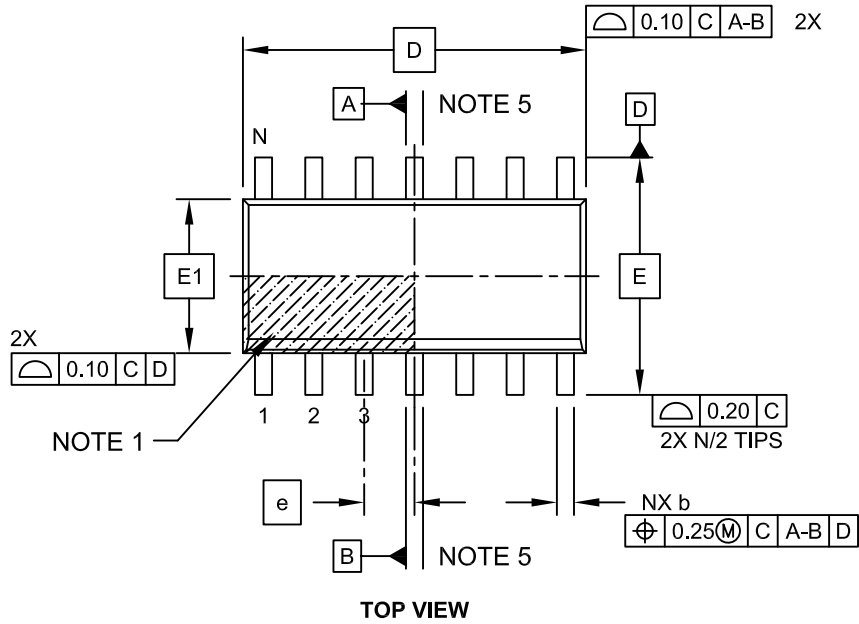
BSC: Basic Dimension. Theoretically exact value shown without tolerances.

Microchip Technology Drawing No. C04-2129A

# MCP6H91/2/4

## 14-Lead Plastic Small Outline (OD) - Narrow, 3.90 mm Body [SOIC]

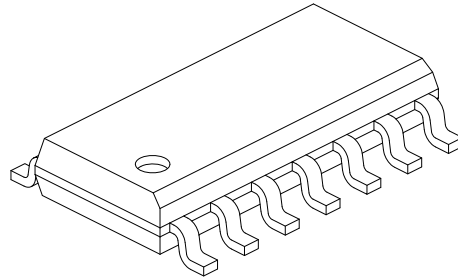
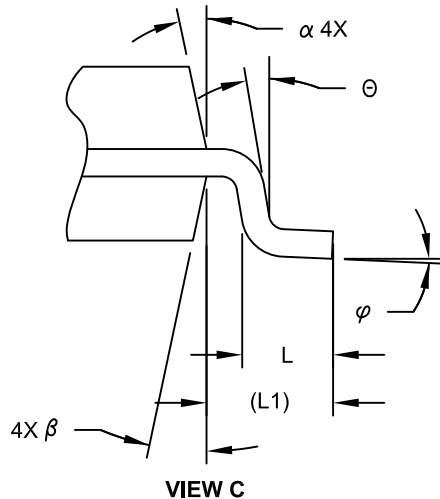
**Note:** For the most current package drawings, please see the Microchip Packaging Specification located at <http://www.microchip.com/packaging>



Microchip Technology Drawing No. C04-065C Sheet 1 of 2

## 14-Lead Plastic Small Outline (SL) - Narrow, 3.90 mm Body [SOIC]

**Note:** For the most current package drawings, please see the Microchip Packaging Specification located at <http://www.microchip.com/packaging>



Dimension Limits	Units	MILLIMETERS		
		MIN	NOM	MAX
Number of Pins	N	14		
Pitch	e	1.27 BSC		
Overall Height	A	-	-	1.75
Molded Package Thickness	A2	1.25	-	-
Standoff §	A1	0.10	-	0.25
Overall Width	E	6.00 BSC		
Molded Package Width	E1	3.90 BSC		
Overall Length	D	8.65 BSC		
Chamfer (Optional)	h	0.25	-	0.50
Foot Length	L	0.40	-	1.27
Footprint	L1	1.04 REF		
Lead Angle	θ	0°	-	-
Foot Angle	φ	0°	-	8°
Lead Thickness	c	0.10	-	0.25
Lead Width	b	0.31	-	0.51
Mold Draft Angle Top	α	5°	-	15°
Mold Draft Angle Bottom	β	5°	-	15°

**Notes:**

- Pin 1 visual index feature may vary, but must be located within the hatched area.
- § Significant Characteristic
- Dimension D does not include mold flash, protrusions or gate burrs, which shall not exceed 0.15 mm per end. Dimension E1 does not include interlead flash or protrusion, which shall not exceed 0.25 mm per side.
- Dimensioning and tolerancing per ASME Y14.5M  
 BSC: Basic Dimension. Theoretically exact value shown without tolerances.  
 REF: Reference Dimension, usually without tolerance, for information purposes only.
- Datums A & B to be determined at Datum H.

Microchip Technology Drawing No. C04-065C Sheet 2 of 2

# MCP6H91/2/4

14-Lead Plastic Small Outline (SL) - Narrow, 3.90 mm Body [SOIC]

**Note:** For the most current package drawings, please see the Microchip Packaging Specification located at <http://www.microchip.com/packaging>



RECOMMENDED LAND PATTERN

Dimension Limits	Units	MILLIMETERS		
		MIN	NOM	MAX
Contact Pitch	E	1.27 BSC		
Contact Pad Spacing	C		5.40	
Contact Pad Width	X			0.60
Contact Pad Length	Y			1.50
Distance Between Pads	Gx	0.67		
Distance Between Pads	G	3.90		

Notes:

1. Dimensioning and tolerancing per ASME Y14.5M

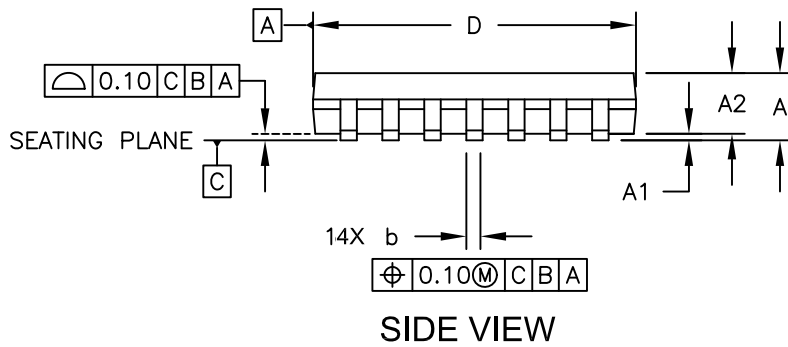
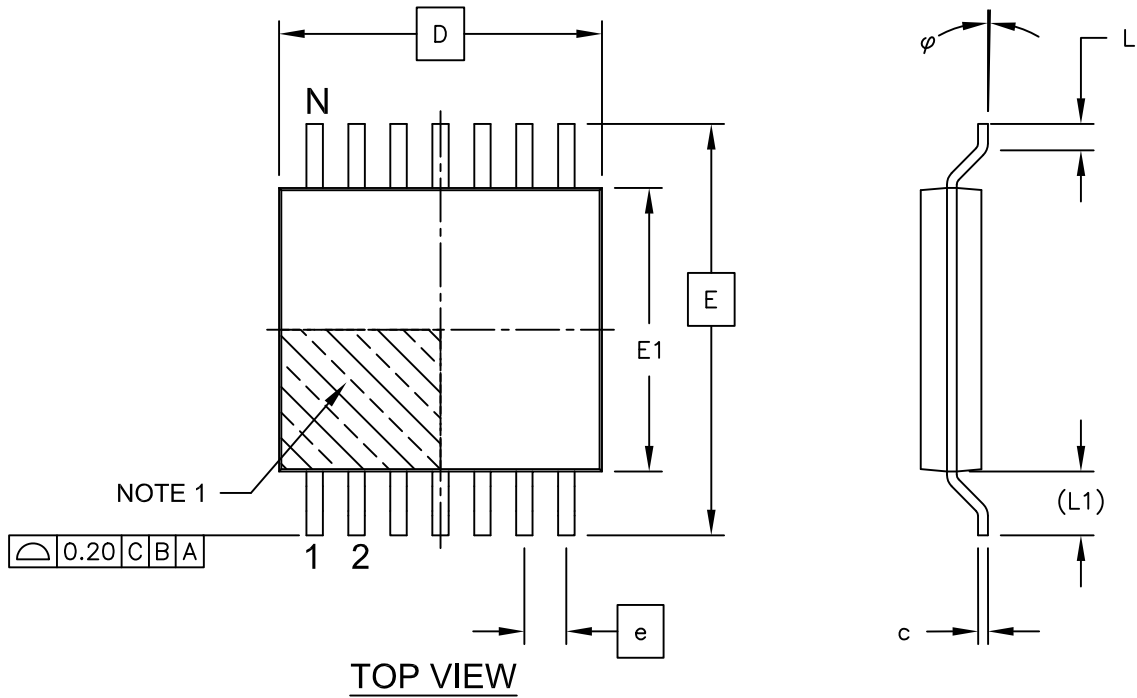
BSC: Basic Dimension. Theoretically exact value shown without tolerances.

Microchip Technology Drawing No. C04-2065A



## 14-Lead Plastic Thin Shrink Small Outline (ST) - 4.4 mm Body [TSSOP]

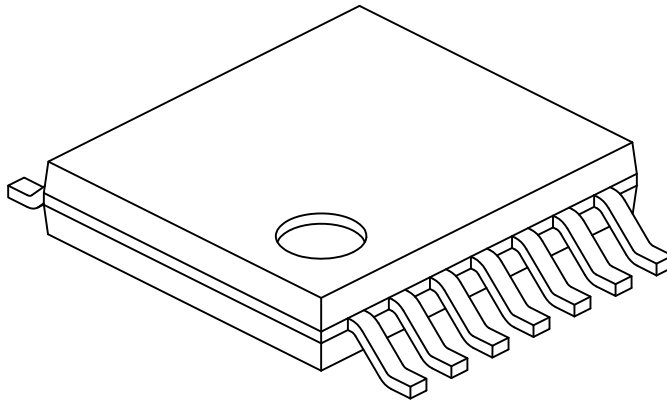
**Note:** For the most current package drawings, please see the Microchip Packaging Specification located at <http://www.microchip.com/packaging>



# MCP6H91/2/4

## 14-Lead Plastic Thin Shrink Small Outline (ST) - 4.4 mm Body [TSSOP]

**Note:** For the most current package drawings, please see the Microchip Packaging Specification located at <http://www.microchip.com/packaging>



Dimension Limits	Units	MILLIMETERS		
		MIN	NOM	MAX
Number of Pins	N	14		
Pitch	e	0.65 BSC		
Overall Height	A	-	-	1.20
Molded Package Thickness	A2	0.80	1.00	1.05
Standoff	A1	0.05	-	0.15
Overall Width	E	6.40 BSC		
Molded Package Width	E1	4.30	4.40	4.50
Molded Package Length	D	4.90	5.00	5.10
Foot Length	L	0.45	0.60	0.75
Footprint	(L1)	1.00 REF		
Foot Angle	$\varphi$	0°	-	8°
Lead Thickness	c	0.09	-	0.20
Lead Width	b	0.19	-	0.30

**Notes:**

1. Pin 1 visual index feature may vary, but must be located within the hatched area.
2. Dimensions D and E1 do not include mold flash or protrusions. Mold flash or protrusions shall not exceed 0.15mm per side.
3. Dimensioning and tolerancing per ASME Y14.5M

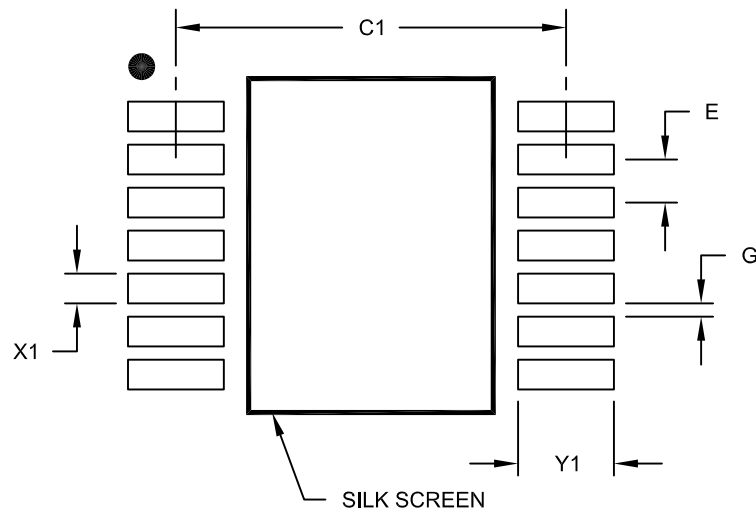
BSC: Basic Dimension. Theoretically exact value shown without tolerances.

REF: Reference Dimension, usually without tolerance, for information purposes only.

Microchip Technology Drawing No. C04-087C Sheet 2 of 2

## 14-Lead Plastic Thin Shrink Small Outline (ST) - 4.4 mm Body [TSSOP]

**Note:** For the most current package drawings, please see the Microchip Packaging Specification located at <http://www.microchip.com/packaging>



RECOMMENDED LAND PATTERN

		Units	MILLIMETERS		
Dimension Limits			MIN	NOM	MAX
Contact Pitch	E		0.65 BSC		
Contact Pad Spacing	C1			5.90	
Contact Pad Width (X14)	X1				0.45
Contact Pad Length (X14)	Y1				1.45
Distance Between Pads	G	0.20			

**Notes:**

1. Dimensioning and tolerancing per ASME Y14.5M

BSC: Basic Dimension. Theoretically exact value shown without tolerances.

Microchip Technology Drawing No. C04-2087A

# MCP6H91/2/4

---

NOTES:

## APPENDIX A: REVISION HISTORY

### Revision B (December 2012)

The following is the list of modifications:

- Updated the  $V_{DD} - V_{SS}$  value in the [Absolute Maximum Ratings †](#) section.

### Revision A (June 2012)

- Original Release of this Document.

# MCP6H91/2/4

---

NOTES:

## PRODUCT IDENTIFICATION SYSTEM

To order or obtain information, e.g., on pricing or delivery, refer to the factory or the listed sales office.

<u>PART NO.</u>	<u>-X</u>	<u>/XX</u>	<b>Examples:</b>
Device	Temperature Range	Package	
<b>Device:</b>	MCP6H91:	Single Op Amp	a) MCP6H91-E/SN: 8LD SOIC pkg., Extended Temp.
	MCP6H91T:	Single Op Amp (Tape and Reel) (SOIC and 2x3 TDFN)	b) MCP6H91T-E/SN: Tape and Reel, Extended Temp., 8LD SOIC pkg.
	MCP6H92:	Dual Op Amp	c) MCP6H91T-E/MNY: Tape and Reel, Extended Temp., 8LD 2x3 TDFN pkg.
	MCP6H92T:	Dual Op Amp (Tape and Reel) (SOIC and 2x3 TDFN)	d) MCP6H92-E/SN: Extended Temp, 8LD SOIC pkg.
	MCP6H94:	Quad Op Amp	e) MCP6H92T-E/SN: Tape and Reel, Extended Temp., 8LD SOIC pkg.
	MCP6H94T:	Quad Op Amp (Tape and Reel) (SOIC and TSSOP)	f) MCP6H92T-E/MNY: Tape and Reel, Extended Temp., 8LD 2x3 TDFN pkg.
<b>Temperature Range:</b>	E	= -40°C to +125°C (Extended)	g) MCP6H94-E/SL: Extended Temp., 14LD SOIC pkg.
<b>Package:</b>	MNY *	= Plastic Dual Flat, No Lead, (2x3 TDFN) 8-lead (TDFN)	h) MCP6H94T-E/SL: Tape and Reel, Extended Temp., 14LD SOIC pkg.
	SN	= Lead Plastic Small Outline (150 mil Body), 8-lead (SOIC)	i) MCP6H94-E/ST: Extended Temp., 14LD TSSOP pkg.
	SL	= Plastic Small Outline, (150 mil Body), 14-lead (SOIC)	j) MCP6H94T-E/ST: Tape and Reel, Extended Temp., 14LD TSSOP pkg.
	ST	= Plastic Thin Shrink Small Outline (150 mil Body), 14-lead (TSSOP)	
	* Y = Nickel palladium gold manufacturing designator. Only available on the TDFN package.		

# MCP6H91/2/4

---

NOTES:



---

---

**Note the following details of the code protection feature on Microchip devices:**

- Microchip products meet the specification contained in their particular Microchip Data Sheet.
- Microchip believes that its family of products is one of the most secure families of its kind on the market today, when used in the intended manner and under normal conditions.
- There are dishonest and possibly illegal methods used to breach the code protection feature. All of these methods, to our knowledge, require using the Microchip products in a manner outside the operating specifications contained in Microchip's Data Sheets. Most likely, the person doing so is engaged in theft of intellectual property.
- Microchip is willing to work with the customer who is concerned about the integrity of their code.
- Neither Microchip nor any other semiconductor manufacturer can guarantee the security of their code. Code protection does not mean that we are guaranteeing the product as “unbreakable.”

Code protection is constantly evolving. We at Microchip are committed to continuously improving the code protection features of our products. Attempts to break Microchip's code protection feature may be a violation of the Digital Millennium Copyright Act. If such acts allow unauthorized access to your software or other copyrighted work, you may have a right to sue for relief under that Act.

---

Information contained in this publication regarding device applications and the like is provided only for your convenience and may be superseded by updates. It is your responsibility to ensure that your application meets with your specifications. MICROCHIP MAKES NO REPRESENTATIONS OR WARRANTIES OF ANY KIND WHETHER EXPRESS OR IMPLIED, WRITTEN OR ORAL, STATUTORY OR OTHERWISE, RELATED TO THE INFORMATION, INCLUDING BUT NOT LIMITED TO ITS CONDITION, QUALITY, PERFORMANCE, MERCHANTABILITY OR FITNESS FOR PURPOSE. Microchip disclaims all liability arising from this information and its use. Use of Microchip devices in life support and/or safety applications is entirely at the buyer's risk, and the buyer agrees to defend, indemnify and hold harmless Microchip from any and all damages, claims, suits, or expenses resulting from such use. No licenses are conveyed, implicitly or otherwise, under any Microchip intellectual property rights.

#### **Trademarks**

The Microchip name and logo, the Microchip logo, dsPIC, FlashFlex, KEELOQ, KEELOQ logo, MPLAB, PIC, PICmicro, PICSTART, PIC<sup>32</sup> logo, rPIC, SST, SST Logo, SuperFlash and UNI/O are registered trademarks of Microchip Technology Incorporated in the U.S.A. and other countries.

FilterLab, Hampshire, HI-TECH C, Linear Active Thermistor, MTP, SEEVAL and The Embedded Control Solutions Company are registered trademarks of Microchip Technology Incorporated in the U.S.A.

Silicon Storage Technology is a registered trademark of Microchip Technology Inc. in other countries.

Analog-for-the-Digital Age, Application Maestro, BodyCom, chipKIT, chipKIT logo, CodeGuard, dsPICDEM, dsPICDEM.net, dsPICworks, dsSPEAK, ECAN, ECONOMONITOR, FanSense, HI-TIDE, In-Circuit Serial Programming, ICSP, Mindi, MiWi, MPASM, MPF, MPLAB Certified logo, MPLIB, MPLINK, mTouch, Omniclient Code Generation, PICC, PICC-18, PICDEM, PICDEM.net, PICkit, PICtail, REAL ICE, rLAB, Select Mode, SQI, Serial Quad I/O, Total Endurance, TSHARC, UniWinDriver, WiperLock, ZENA and Z-Scale are trademarks of Microchip Technology Incorporated in the U.S.A. and other countries.

SQTP is a service mark of Microchip Technology Incorporated in the U.S.A.

GestIC and ULPP are registered trademarks of Microchip Technology Germany II GmbH & Co. & KG, a subsidiary of Microchip Technology Inc., in other countries.

All other trademarks mentioned herein are property of their respective companies.

© 2012, Microchip Technology Incorporated, Printed in the U.S.A., All Rights Reserved.

 Printed on recycled paper.

ISBN: 978-1-62076-758-0

*Microchip received ISO/TS-16949:2009 certification for its worldwide headquarters, design and wafer fabrication facilities in Chandler and Tempe, Arizona; Gresham, Oregon and design centers in California and India. The Company's quality system processes and procedures are for its PIC<sup>®</sup> MCUs and dsPIC<sup>®</sup> DSCs, KEELOQ<sup>®</sup> code hopping devices, Serial EEPROMs, microperipherals, nonvolatile memory and analog products. In addition, Microchip's quality system for the design and manufacture of development systems is ISO 9001:2000 certified.*

---

---

**QUALITY MANAGEMENT SYSTEM  
CERTIFIED BY DNV  
= ISO/TS 16949 =**



# MICROCHIP

## Worldwide Sales and Service

### AMERICAS

**Corporate Office**  
2355 West Chandler Blvd.  
Chandler, AZ 85224-6199  
Tel: 480-792-7200  
Fax: 480-792-7277  
Technical Support:  
<http://www.microchip.com/support>  
Web Address:  
[www.microchip.com](http://www.microchip.com)

**Atlanta**  
Duluth, GA  
Tel: 678-957-9614  
Fax: 678-957-1455

**Boston**  
Westborough, MA  
Tel: 774-760-0087  
Fax: 774-760-0088

**Chicago**  
Itasca, IL  
Tel: 630-285-0071  
Fax: 630-285-0075

**Cleveland**  
Independence, OH  
Tel: 216-447-0464  
Fax: 216-447-0643

**Dallas**  
Addison, TX  
Tel: 972-818-7423  
Fax: 972-818-2924

**Detroit**  
Farmington Hills, MI  
Tel: 248-538-2250  
Fax: 248-538-2260

**Indianapolis**  
Noblesville, IN  
Tel: 317-773-8323  
Fax: 317-773-5453

**Los Angeles**  
Mission Viejo, CA  
Tel: 949-462-9523  
Fax: 949-462-9608

**Santa Clara**  
Santa Clara, CA  
Tel: 408-961-6444  
Fax: 408-961-6445

**Toronto**  
Mississauga, Ontario,  
Canada  
Tel: 905-673-0699  
Fax: 905-673-6509

### ASIA/PACIFIC

**Asia Pacific Office**  
Suites 3707-14, 37th Floor  
Tower 6, The Gateway  
Harbour City, Kowloon  
Hong Kong  
Tel: 852-2401-1200  
Fax: 852-2401-3431

**Australia - Sydney**  
Tel: 61-2-9868-6733  
Fax: 61-2-9868-6755

**China - Beijing**  
Tel: 86-10-8569-7000  
Fax: 86-10-8528-2104

**China - Chengdu**  
Tel: 86-28-8665-5511  
Fax: 86-28-8665-7889

**China - Chongqing**  
Tel: 86-23-8980-9588  
Fax: 86-23-8980-9500

**China - Hangzhou**  
Tel: 86-571-2819-3187  
Fax: 86-571-2819-3189

**China - Hong Kong SAR**  
Tel: 852-2943-5100  
Fax: 852-2401-3431

**China - Nanjing**  
Tel: 86-25-8473-2460  
Fax: 86-25-8473-2470

**China - Qingdao**  
Tel: 86-532-8502-7355  
Fax: 86-532-8502-7205

**China - Shanghai**  
Tel: 86-21-5407-5533  
Fax: 86-21-5407-5066

**China - Shenyang**  
Tel: 86-24-2334-2829  
Fax: 86-24-2334-2393

**China - Shenzhen**  
Tel: 86-755-8864-2200  
Fax: 86-755-8203-1760

**China - Wuhan**  
Tel: 86-27-5980-5300  
Fax: 86-27-5980-5118

**China - Xian**  
Tel: 86-29-8833-7252  
Fax: 86-29-8833-7256

**China - Xiamen**  
Tel: 86-592-2388138  
Fax: 86-592-2388130

**China - Zhuhai**  
Tel: 86-756-3210040  
Fax: 86-756-3210049

### ASIA/PACIFIC

**India - Bangalore**  
Tel: 91-80-3090-4444  
Fax: 91-80-3090-4123

**India - New Delhi**  
Tel: 91-11-4160-8631  
Fax: 91-11-4160-8632

**India - Pune**  
Tel: 91-20-2566-1512  
Fax: 91-20-2566-1513

**Japan - Osaka**  
Tel: 81-6-6152-7160  
Fax: 81-6-6152-9310

**Japan - Tokyo**  
Tel: 81-3-6880-3770  
Fax: 81-3-6880-3771

**Korea - Daegu**  
Tel: 82-53-744-4301  
Fax: 82-53-744-4302

**Korea - Seoul**  
Tel: 82-2-554-7200  
Fax: 82-2-558-5932 or  
82-2-558-5934

**Malaysia - Kuala Lumpur**  
Tel: 60-3-6201-9857  
Fax: 60-3-6201-9859

**Malaysia - Penang**  
Tel: 60-4-227-8870  
Fax: 60-4-227-4068

**Philippines - Manila**  
Tel: 63-2-634-9065  
Fax: 63-2-634-9069

**Singapore**  
Tel: 65-6334-8870  
Fax: 65-6334-8850

**Taiwan - Hsin Chu**  
Tel: 886-3-5778-366  
Fax: 886-3-5770-955

**Taiwan - Kaohsiung**  
Tel: 886-7-213-7828  
Fax: 886-7-330-9305

**Taiwan - Taipei**  
Tel: 886-2-2508-8600  
Fax: 886-2-2508-0102

**Thailand - Bangkok**  
Tel: 66-2-694-1351  
Fax: 66-2-694-1350

### EUROPE

**Austria - Wels**  
Tel: 43-7242-2244-39  
Fax: 43-7242-2244-393

**Denmark - Copenhagen**  
Tel: 45-4450-2828  
Fax: 45-4485-2829

**France - Paris**  
Tel: 33-1-69-53-63-20  
Fax: 33-1-69-30-90-79

**Germany - Munich**  
Tel: 49-89-627-144-0  
Fax: 49-89-627-144-44

**Italy - Milan**  
Tel: 39-0331-742611  
Fax: 39-0331-466781

**Netherlands - Drunen**  
Tel: 31-416-690399  
Fax: 31-416-690340

**Spain - Madrid**  
Tel: 34-91-708-08-90  
Fax: 34-91-708-08-91

**UK - Wokingham**  
Tel: 44-118-921-5869  
Fax: 44-118-921-5820

11/29/12

# Mouser Electronics

Authorized Distributor

Click to View Pricing, Inventory, Delivery & Lifecycle Information:

[Microchip:](#)

[MCP6H94-E/ST](#) [MCP6H94-E/SL](#) [MCP6H94T-E/ST](#) [MCP6H94T-E/SL](#)