

MATE FIRST BREAK LAST OPTION
SEE CHART FOR LOCATION

VOIDED CIRCUIT OPTION
SEE CHART FOR LOCATION

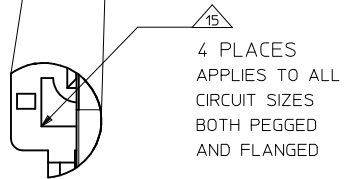
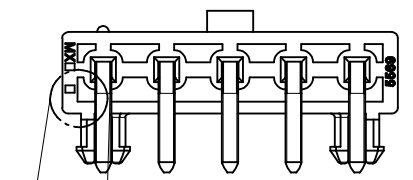
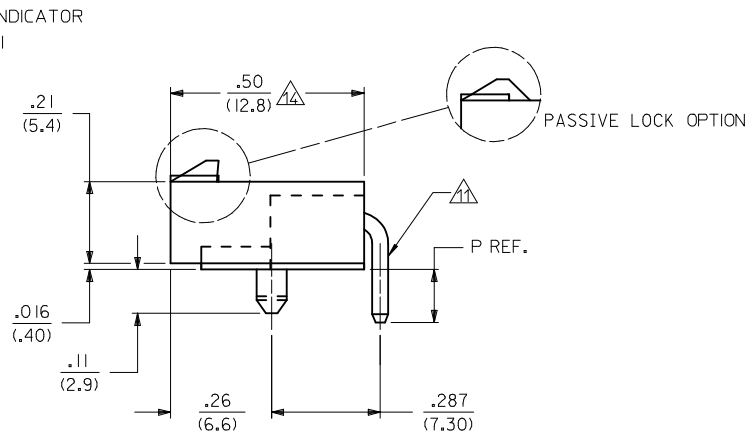
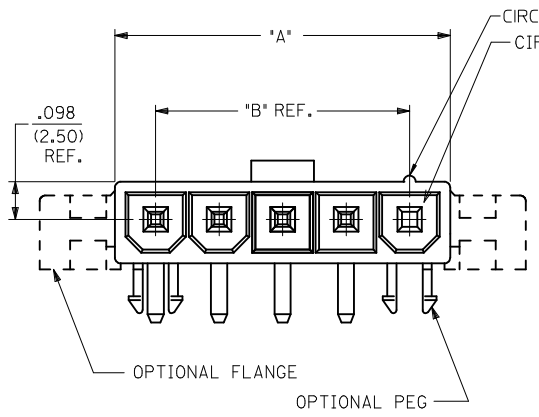

CIRCUIT SIZE	DIM. "A"	DIM. "B"	DIM. "C"	DIM. "D"
2	.378 (9.60)	.165 (4.20)	.772 (19.60)	.520 (13.20)
3	.543 (13.80)	.331 (8.40)	.937 (23.80)	.685 (17.40)
4	.709 (18.00)	.496 (12.60)	1.102 (28.00)	.850 (21.60)
5	.874 (22.20)	.661 (16.80)	1.268 (32.20)	1.016 (25.80)
6	1.039 (26.40)	.827 (21.00)	1.433 (36.40)	1.181 (30.00)

- NOTES:
- MATERIAL:
 - HOUSING:
 - A - NYLON 6/6, UL 94V-2, LOW HALOGEN, COLOR: NATURAL
 - B - NYLON 6/6, UL 94V-0, LOW HALOGEN, COLOR: NATURAL
 - D - NYLON 6/6, UL 94V-0, LOW HALOGEN, COLOR: BLACK
 - TERMINALS: BRASS
 - FINISH (TERMINAL PLATING):
 - A - .000100/(0.00254) MIN. MATTE TIN OVER .000050/(0.00127) MIN. NICKEL OVERALL.
 - B - .000030/(0.00076) MIN. SELECT GOLD AND .000100/(0.00254) MIN. SELECT MATTE TIN OVER .000050/(0.00127) MIN. NICKEL OVERALL
 - PRODUCT SPECIFICATION: PS-5556-001
 - PACKAGING: BULK PACKAGED PER PK-5569-002 TRAY PACKAGED PER PK-5569-005
 - PART MATES WITH MINI-FIT JR. RECEPTACLE #5557.
 - MOUNTING OPTIONS:
 - 1 - PEGS
 - 2 - FLANGES
 - LOCK RAMP STYLES:
 - 1 - POSITIVE LOCK
 - 2- PASSIVE LOCK
 - PARTS ARE NOT TO BE MATED OR UNMATED WHILE CIRCUITS ARE LIVE.
 - PART IS NOT DESIGNED FOR CURRENT SHARING.
 - PART CONFORMS TO CLASS "B" REQUIREMENTS OF COSMETIC SPECIFICATION PS-45499-002.
 - FORMING MARKS ARE ACCEPTABLE
 - DISCOLORATION IN THE BANDOLIER CARRIER AREA OF THE PIN IS INHERENT TO THE PLATING PROCESS AND IS DUE TO THE MASKING EFFECT OF THE CARRIER. THIS DISCOLORATION IS IN A NON-FUNCTIONAL AREA OF THE PIN AND WILL NOT AFFECT THE PERFORMANCE OF THE HEADER ASSEMBLY.
 - FOR 3 CKT PART NUMBERS, THIS DIMENSION IS .37/9.35
 - FOR 3 CKT PART NUMBERS, THIS DIMENSION IS .49/12.45
 - CORNER CORE-OUTS ARE OPTIONAL AND MAY OR MAY NOT BE PRESENT
 - TEXT ON PART IS FOR REFERENCE ONLY. TEXT AND TEXT LOCATION MAY VARY DEPENDING ON PART NUMBER AND/OR TOOL.

ADD 2 CKT VIEW EC NO: UCP2017-2789 DRWN: BAPPELDORN 2017/06/26 CHKD: J.BELL 2017/06/26 APPR: FSMITH 2017/06/28	QUALITY SYMBOLS ▽=0 ▽=0 ▽=0	GENERAL TOLERANCES (UNLESS SPECIFIED) <table border="1"> <thead> <tr> <th></th> <th>mm</th> <th>INCH</th> </tr> </thead> <tbody> <tr> <td>4 PLACES</td> <td>± .015</td> <td>± .0005</td> </tr> <tr> <td>3 PLACES</td> <td>± .015</td> <td>± .0005</td> </tr> <tr> <td>2 PLACES</td> <td>± .038</td> <td>± .0015</td> </tr> <tr> <td>1 PLACE</td> <td>± .076</td> <td>± .0030</td> </tr> </tbody> </table>		mm	INCH	4 PLACES	± .015	± .0005	3 PLACES	± .015	± .0005	2 PLACES	± .038	± .0015	1 PLACE	± .076	± .0030	DIMENSION STYLE IN/MM	SCALE 4:1	DESIGN UNITS METRIC	THIRD ANGLE PROJECTION
		mm	INCH																		
	4 PLACES	± .015	± .0005																		
	3 PLACES	± .015	± .0005																		
2 PLACES	± .038	± .0015																			
1 PLACE	± .076	± .0030																			
DRAWN BY POLGAR	DATE 1993/02/01	TITLE MINI-FIT JR. SINGLE ROW HEADER WITH MF/BL AND VOIDED CIRCUITS OPTION																			
CHECKED BY FRY	DATE 1993/02/01	MOLEX INCORPORATED																			
APPROVED BY FSMITH	DATE 2011/06/21	MATERIAL NO. SEE SHEET 3	DOCUMENT NO. SDA-43232-*	SHEET NO. 1 OF 3	THIS DRAWING CONTAINS INFORMATION THAT IS PROPRIETARY TO MOLEX INCORPORATED AND SHOULD NOT BE USED WITHOUT WRITTEN PERMISSION																

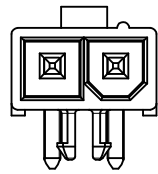

2 CIRCUIT

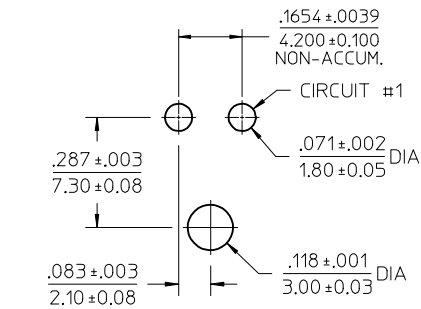

RECOMMENDED HOLE LAYOUT FOR
.070/ 1.78 MAX. THICK P.C. BOARD
VIEWED FROM COMPONENT SIDE
2 CIRCUIT PART

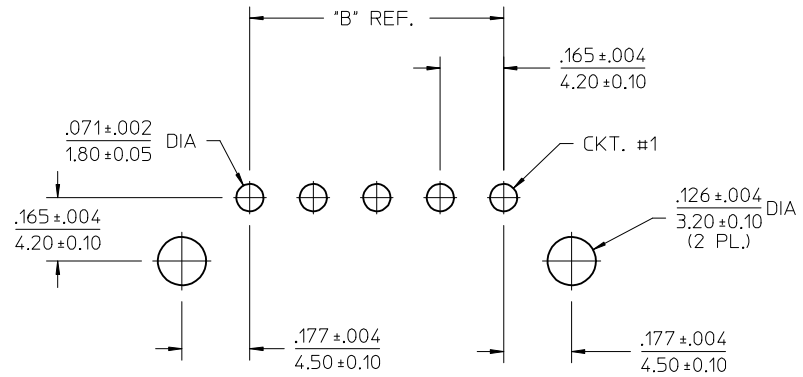

RECOMMENDED HOLE LAYOUT FOR
.070/(1.78) MAX. THICK P.C. BOARD.
VIEWED FROM COMPONENT SIDE
(FLANGE MOUNT)

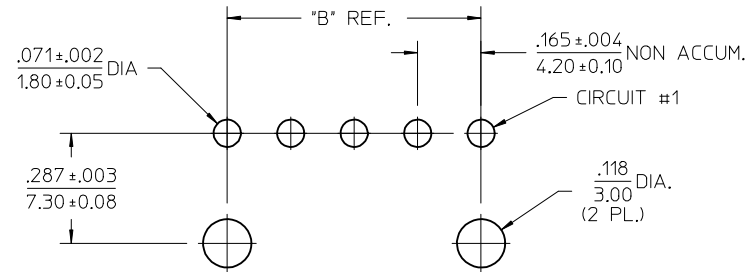

RECOMMENDED HOLE LAYOUT FOR
.070/(1.78) MAX. THICK P.C. BOARD.
VIEWED FROM COMPONENT SIDE
(PEG MOUNT 3-12 CIRCUIT)

SEE SHEET 1 IEC NO: UCP2017-2789 DRWN:APPELDORN 2017/06/26 CHKD:JBELL 2017/06/26 APPR:FSMITH 2017/06/28	DESCRIPTION REV	QUALITY SYMBOLS	GENERAL TOLERANCES (UNLESS SPECIFIED)	DIMENSION STYLE	SCALE	DESIGN UNITS	THIRD ANGLE PROJECTION
		▽=0	mm INCH	IN/MM	4:1	METRIC	MINI-FIT JR. SINGLE ROW HEADER WITH MF/BL AND VOIDED CIRCUITS OPTION
		▽=0	4 PLACES ± --- ± ---	DRAWN BY DATE	POLGAR 1993/02/01 CHECKED BY DATE FRY 1993/02/01 APPROVED BY DATE FSMITH 2011/06/21	MOLEX INCORPORATED	
		▽=0	3 PLACES ± --- ± .015	MATERIAL NO.			DOCUMENT NO.
DRAFT WHERE APPLICABLE MUST REMAIN WITHIN DIMENSIONS			2 PLACES ± 0.38 ± --- 1 PLACE ± --- ± --- ANGULAR ± 1/2°	SEE SHEET 3 SDA-43232-*	2 OF 3	THIS DRAWING CONTAINS INFORMATION THAT IS PROPRIETARY TO MOLEX INCORPORATED AND SHOULD NOT BE USED WITHOUT WRITTEN PERMISSION	

ITEM NO.	CKT. SIZE	CHARACTERISTIC DESCRIPTION	HOUSING OPTION	PLATING	LETTER INDICATES PIN OPTION AT EACH CKT.,. SEE NOTE 2												DIM P REF	PACKAGING
					1	2	3	4	5	6	7	8	9	10	11	12		
432320001	05	05A IA I	PEG	A	SA	SA	V	SA	SA	-	-	-	-	-	-	-	.138/3.50	BULK
432320002	05	05A IA I	PEG	A	MA	SA	SA	SA	SA	-	-	-	-	-	-	-	.138/3.50	BULK
432320003	05	05B IA I	PEG	A	MA	SA	SA	SA	SA	-	-	-	-	-	-	-	.138/3.50	BULK
432320004	05	05B IA I	PEG	A	SA	V	SA	V	MA	-	-	-	-	-	-	-	.138/3.50	BULK
432320005	05	05A IA I	PEG	A	SA	V	SA	SA	SA	-	-	-	-	-	-	-	.138/3.50	BULK
432320006	05	05B IA I	PEG	A	SA	SA	SA	V	MA	-	-	-	-	-	-	-	.138/3.50	BULK
432320007	04	04B1A1	PEG	A	SA	MA	MA	SA	-	-	-	-	-	-	-	-	.138/3.50	BULK
432320008	04	04B1A1	PEG	A	MA	SA	SA	MA	-	-	-	-	-	-	-	-	.138/3.50	BULK
432320009	03	03B1A1	PEG	A	SA	V	SA	-	-	-	-	-	-	-	-	-	.138/3.50	BULK
432320010	03	03B1B1	PEG	B	SB	V	SB	-	-	-	-	-	-	-	-	-	.138/3.50	BULK
432320011	05	05B1B1	PEG	B	SB	SB	V	SB	SB	-	-	-	-	-	-	-	.138/3.50	BULK
432320012	05	05A1A1	PEG	A	SA	SA	SA	V	SA	-	-	-	-	-	-	-	.138/3.50	BULK
432320013	03	03B1A1	PEG	A	SA	SA	SA	-	-	-	-	-	-	-	-	-	.31/8.0	TRAY
432320014	05	05B1A1	PEG	A	SA	SA	SA	SA	SA	-	-	-	-	-	-	-	.31/8.0	TRAY
432320016	05	05A1A1	PEG	A	SA	V	V	V	SA	-	-	-	-	-	-	-	.138/3.50	BULK
432320017	04	04B1A1	PEG	A	SA	V	V	SA	-	-	-	-	-	-	-	-	.138/3.50	BULK
432320018	04	04B1B1	PEG	B	SB	V	V	SB	-	-	-	-	-	-	-	-	.138/3.50	BULK
432320019	05	05B1A1	PEG	A	SA	V	SA	V	SA	-	-	-	-	-	-	-	.138/3.50	BULK
432320020	03	03D1A1	PEG	A	SA	V	SA	-	-	-	-	-	-	-	-	-	.138/3.50	BULK
432320021	05	05B1A1	PEG	A	SA	V	V	SA	V	-	-	-	-	-	-	-	.138/3.50	BULK
432320022	03	03B1A1	PEG	A	SA	SA	SA	-	-	-	-	-	-	-	-	-	.18/4.5	BULK

CODE	PIN TYPE	PLATING
SA	STANDARD	MATTE TIN
MA	MF/BL	MATTE TIN
SB	STANDARD	SELECT GOLD
MB	MF/BL	SELECT GOLD
V	VOID	

CHARACTERISTICS LEGEND:

CIRCUIT SIZE _____ ** * * * *

(02-06)

HOUSING MATERIAL _____

A = NYLON 6/6, U.L. 94V-2,
COLOR: NATURAL

B = NYLON 6/6, U.L. 94V-0,
COLOR: NATURAL

D = NYLON 6/6, U.L. 94V-0,
COLOR: BLACK

MOUNTING OPTION _____

1 = PEGS
2 = FLANGES

PLATING COMBINATION _____

A = MATTE TIN OVER NICKEL
B = SELECT GOLD AND
SELECT MATTE TIN
OVER NICKEL OVERALL

LOCK RAMP STYLE _____

1 = POSITIVE LOCK
2 = PASSIVE LOCK

SEE SHEET 1 EC NO: UCP2017-2789 DRWN:APPELDORN 2017/06/26 CHKD:JBELL 2017/06/26 APPR:FSMITH 2017/06/28 REV:	QUALITY SYMBOLS	GENERAL TOLERANCES (UNLESS SPECIFIED)	DIMENSION STYLE	SCALE	DESIGN UNITS	THIRD ANGLE PROJECTION
	▽=0	mm INCH	IN/MM	4:1	METRIC	
	▽=0	4 PLACES ± --- ± ---	DRAWN BY DATE	TITLE		
	▽=0	3 PLACES ± --- ± .015	POLGAR 1993/02/01	MINI-FIT JR. SINGLE ROW HEADER WITH MF/BL AND VOIDED CIRCUITS OPTION		
	▽=0	2 PLACES ± 0.38 ± ---	CHECKED BY DATE			
	1 PLACE ± --- ± ---	FRY 1993/02/01				
	0 PLACE ± ±	APPROVED BY DATE	DOCUMENT NO.			
		FSMITH 2011/06/21	SDA-43232-*			
			SHEET NO.			
			3 OF 3			
			THIS DRAWING CONTAINS INFORMATION THAT IS PROPRIETARY TO MOLEX INCORPORATED AND SHOULD NOT BE USED WITHOUT WRITTEN PERMISSION			

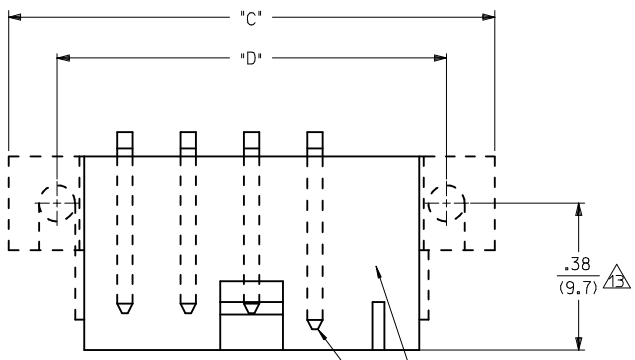

MATE FIRST BREAK LAST OPTION
SEE CHART FOR LOCATION

VOIDED CIRCUIT OPTION
SEE CHART FOR LOCATION

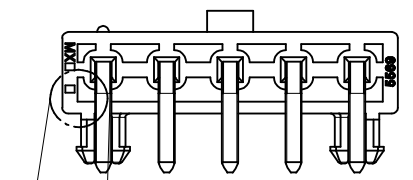
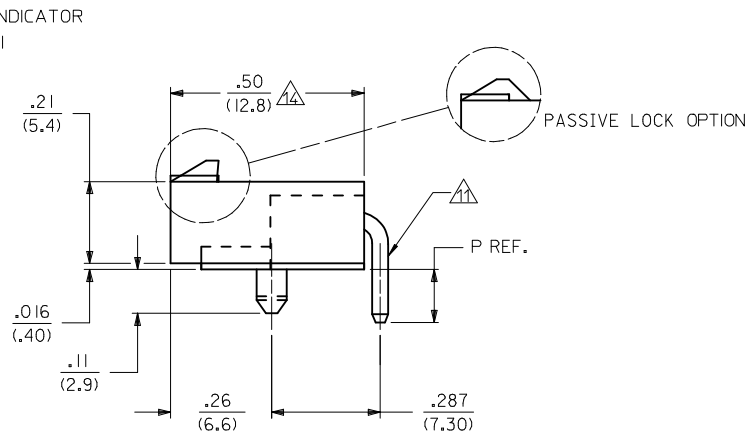
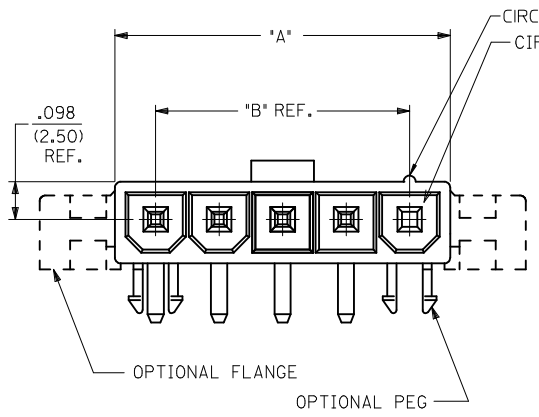

4 PLACES
APPLIES TO ALL
CIRCUIT SIZES
BOTH PEGGED
AND FLANGED

CIRCUIT SIZE	DIM. "A"	DIM. "B"	DIM. "C"	DIM. "D"
2	.378 (9.60)	.165 (4.20)	.772 (19.60)	.520 (13.20)
3	.543 (13.80)	.331 (8.40)	.937 (23.80)	.685 (17.40)
4	.709 (18.00)	.496 (12.60)	1.102 (28.00)	.850 (21.60)
5	.874 (22.20)	.661 (16.80)	1.268 (32.20)	1.016 (25.80)
6	1.039 (26.40)	.827 (21.00)	1.433 (36.40)	1.181 (30.00)

- NOTES:
- MATERIAL:
 - HOUSING:
 - A - NYLON 6/6, UL 94V-2, LOW HALOGEN, COLOR: NATURAL
 - B - NYLON 6/6, UL 94V-0, LOW HALOGEN, COLOR: NATURAL
 - D - NYLON 6/6, UL 94V-0, LOW HALOGEN, COLOR: BLACK
 - TERMINALS: BRASS
 - FINISH (TERMINAL PLATING):
 - A - .000100/(0.00254) MIN. MATTE TIN OVER .000050/(0.00127) MIN. NICKEL OVERALL.
 - B - .000030/(0.00076) MIN. SELECT GOLD AND .000100/(0.00254) MIN. SELECT MATTE TIN OVER .000050/(0.00127) MIN. NICKEL OVERALL
 - PRODUCT SPECIFICATION: PS-5556-001
 - PACKAGING: BULK PACKAGED PER PK-5569-002
TRAY PACKAGED PER PK-5569-005
 - PART MATES WITH MINI-FIT JR. RECEPTACLE #5557.
 - MOUNTING OPTIONS:
 - 1 - PEGS
 - 2 - FLANGES
 - LOCK RAMP STYLES:
 - 1 - POSITIVE LOCK
 - 2 - PASSIVE LOCK
 - PARTS ARE NOT TO BE MATED OR UNMATED WHILE CIRCUITS ARE LIVE.
 - PART IS NOT DESIGNED FOR CURRENT SHARING.
 - PART CONFORMS TO CLASS "B" REQUIREMENTS OF COSMETIC SPECIFICATION PS-45499-002.
 - FORMING MARKS ARE ACCEPTABLE
 - DISCOLORATION IN THE BANDOLIER CARRIER AREA OF THE PIN IS INHERENT TO THE PLATING PROCESS AND IS DUE TO THE MASKING EFFECT OF THE CARRIER. THIS DISCOLORATION IS IN A NON-FUNCTIONAL AREA OF THE PIN AND WILL NOT AFFECT THE PERFORMANCE OF THE HEADER ASSEMBLY.
 - FOR 3 CKT PART NUMBERS, THIS DIMENSION IS .37/9.35
 - FOR 3 CKT PART NUMBERS, THIS DIMENSION IS .49/12.45
 - CORNER CORE-OUTS ARE OPTIONAL AND MAY OR MAY NOT BE PRESENT
 - TEXT ON PART IS FOR REFERENCE ONLY. TEXT AND TEXT LOCATION MAY VARY DEPENDING ON PART NUMBER AND/OR TOOL.

ADD 2 CKT VIEW EC NO: UCP2017-2789 DRWN: BAPPELDORN 2017/06/26 CHKD: J.BELL 2017/06/26 APPR: FSMITH 2017/06/28	QUALITY SYMBOLS ▽=0 ▽=0 ▽=0	GENERAL TOLERANCES (UNLESS SPECIFIED)		DIMENSION STYLE IN/MM		SCALE 4:1	DESIGN UNITS METRIC	THIRD ANGLE PROJECTION	
		4 PLACES ± --- ± --- 3 PLACES ± --- ± .015 2 PLACES ± 0.38 ± --- 1 PLACE ± --- ± ---	mm INCH ± --- ± --- ± --- ± --- ± --- ± ---	DRAWN BY POLGAR	DATE 1993/02/01	TITLE MINI-FIT JR. SINGLE ROW HEADER WITH MF/BL AND VOIDED CIRCUITS OPTION		MOLEX INCORPORATED	
C13	DESCRIPTION ADD 2 CKT VIEW	MATERIAL NO. SEE SHEET 3		DATE 2011/06/21		DOCUMENT NO. SDA-43232-*		THIS DRAWING CONTAINS INFORMATION THAT IS PROPRIETARY TO MOLEX INCORPORATED AND SHOULD NOT BE USED WITHOUT WRITTEN PERMISSION	

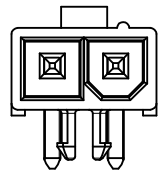

2 CIRCUIT

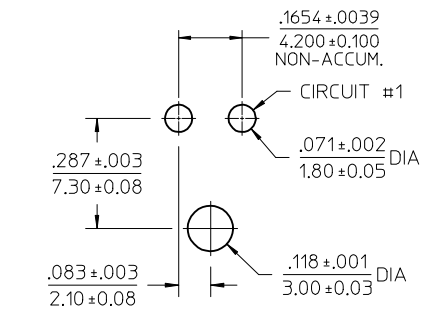

RECOMMENDED HOLE LAYOUT FOR
.070/ 1.78 MAX. THICK P.C. BOARD
VIEWED FROM COMPONENT SIDE
2 CIRCUIT PART

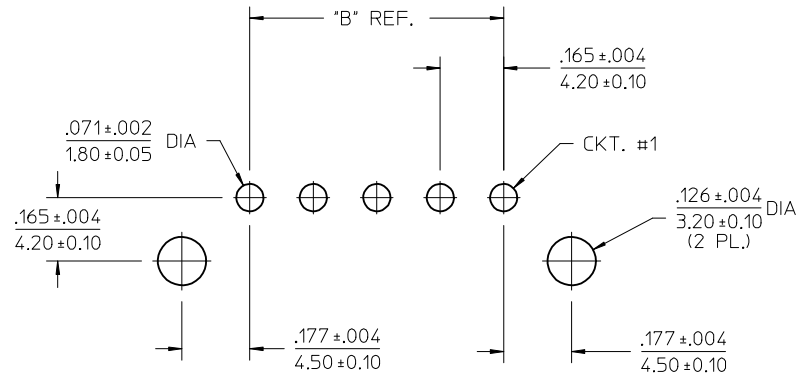

RECOMMENDED HOLE LAYOUT FOR
.070/(1.78) MAX. THICK P.C. BOARD.
VIEWED FROM COMPONENT SIDE
(FLANGE MOUNT)

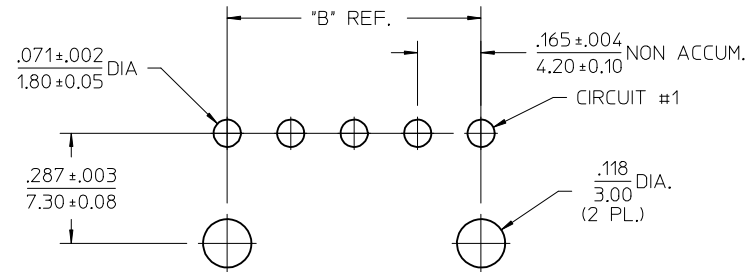

RECOMMENDED HOLE LAYOUT FOR
.070/(1.78) MAX. THICK P.C. BOARD.
VIEWED FROM COMPONENT SIDE
(PEG MOUNT 3-12 CIRCUIT)

SEE SHEET 1 IEC NO: UCP2017-2789 DRWN:APPELDORN 2017/06/26 CHKD:JBELL 2017/06/26 APPR:FSMITH 2017/06/28	QUALITY SYMBOLS ▽=0 ▽=0 ▽=0	GENERAL TOLERANCES (UNLESS SPECIFIED)		DIMENSION STYLE IN/MM		SCALE 4:1	DESIGN UNITS METRIC	THIRD ANGLE PROJECTION			
		4 PLACES ± --- ± ---	3 PLACES ± --- ± .015	2 PLACES ± 0.38 ± ---	1 PLACE ± --- ± ---	DRAWN BY POLGAR	DATE 1993/02/01	MINI-FIT JR. SINGLE ROW HEADER WITH MF/BL AND VOIDED CIRCUITS OPTION			
		ANGULAR ± 1/2°				CHECKED BY FRY	DATE 1993/02/01				
		DRAFT WHERE APPLICABLE MUST REMAIN WITHIN DIMENSIONS				APPROVED BY FSMITH	DATE 2011/06/21	MOLEX INCORPORATED		SHEET NO. 2 OF 3	
SEE SHEET 3				MATERIAL NO.		DOCUMENT NO.		SDA-43232-*			
THIS DRAWING CONTAINS INFORMATION THAT IS PROPRIETARY TO MOLEX INCORPORATED AND SHOULD NOT BE USED WITHOUT WRITTEN PERMISSION											

ITEM NO.	CKT. SIZE	CHARACTERISTIC DESCRIPTION	HOUSING OPTION	PLATING	LETTER INDICATES PIN OPTION AT EACH CKT.,. SEE NOTE 2												DIM P REF	PACKAGING
					1	2	3	4	5	6	7	8	9	10	11	12		
432320001	05	05A IA I	PEG	A	SA	SA	V	SA	SA	-	-	-	-	-	-	-	.138/3.50	BULK
432320002	05	05A IA I	PEG	A	MA	SA	SA	SA	SA	-	-	-	-	-	-	-	.138/3.50	BULK
432320003	05	05B IA I	PEG	A	MA	SA	SA	SA	SA	-	-	-	-	-	-	-	.138/3.50	BULK
432320004	05	05B IA I	PEG	A	SA	V	SA	V	MA	-	-	-	-	-	-	-	.138/3.50	BULK
432320005	05	05A IA I	PEG	A	SA	V	SA	SA	SA	-	-	-	-	-	-	-	.138/3.50	BULK
432320006	05	05B IA I	PEG	A	SA	SA	SA	V	MA	-	-	-	-	-	-	-	.138/3.50	BULK
432320007	04	04B1A1	PEG	A	SA	MA	MA	SA	-	-	-	-	-	-	-	-	.138/3.50	BULK
432320008	04	04B1A1	PEG	A	MA	SA	SA	MA	-	-	-	-	-	-	-	-	.138/3.50	BULK
432320009	03	03B1A1	PEG	A	SA	V	SA	-	-	-	-	-	-	-	-	-	.138/3.50	BULK
432320010	03	03B1B1	PEG	B	SB	V	SB	-	-	-	-	-	-	-	-	-	.138/3.50	BULK
432320011	05	05B1B1	PEG	B	SB	SB	V	SB	SB	-	-	-	-	-	-	-	.138/3.50	BULK
432320012	05	05A1A1	PEG	A	SA	SA	SA	V	SA	-	-	-	-	-	-	-	.138/3.50	BULK
432320013	03	03B1A1	PEG	A	SA	SA	SA	-	-	-	-	-	-	-	-	-	.31/8.0	TRAY
432320014	05	05B1A1	PEG	A	SA	SA	SA	SA	SA	-	-	-	-	-	-	-	.31/8.0	TRAY
432320016	05	05A1A1	PEG	A	SA	V	V	V	SA	-	-	-	-	-	-	-	.138/3.50	BULK
432320017	04	04B1A1	PEG	A	SA	V	V	SA	-	-	-	-	-	-	-	-	.138/3.50	BULK
432320018	04	04B1B1	PEG	B	SB	V	V	SB	-	-	-	-	-	-	-	-	.138/3.50	BULK
432320019	05	05B1A1	PEG	A	SA	V	SA	V	SA	-	-	-	-	-	-	-	.138/3.50	BULK
432320020	03	03D1A1	PEG	A	SA	V	SA	-	-	-	-	-	-	-	-	-	.138/3.50	BULK
432320021	05	05B1A1	PEG	A	SA	V	V	SA	V	-	-	-	-	-	-	-	.138/3.50	BULK
432320022	03	03B1A1	PEG	A	SA	SA	SA	-	-	-	-	-	-	-	-	-	.18/4.5	BULK

CODE	PIN TYPE	PLATING
SA	STANDARD	MATTE TIN
MA	MF/BL	MATTE TIN
SB	STANDARD	SELECT GOLD
MB	MF/BL	SELECT GOLD
V	VOID	

CHARACTERISTICS LEGEND:

CIRCUIT SIZE _____ ** * * * *

(02-06)

HOUSING MATERIAL _____

A = NYLON 6/6, U.L. 94V-2,
COLOR: NATURAL

B = NYLON 6/6, U.L. 94V-0,
COLOR: NATURAL

D = NYLON 6/6, U.L. 94V-0,
COLOR: BLACK

MOUNTING OPTION _____

1 = PEGS
2 = FLANGES

PLATING COMBINATION _____

A = MATTE TIN OVER NICKEL
B = SELECT GOLD AND
SELECT MATTE TIN
OVER NICKEL OVERALL

LOCK RAMP STYLE _____

1 = POSITIVE LOCK
2 = PASSIVE LOCK

SEE SHEET 1 EC NO: UCP2017-2789 DRWN:APPELDORN 2017/06/26 CHKD:JBELL 2017/06/26 APPR:FSMITH 2017/06/28 REV:	QUALITY SYMBOLS	GENERAL TOLERANCES (UNLESS SPECIFIED)	DIMENSION STYLE	SCALE	DESIGN UNITS	THIRD ANGLE PROJECTION
	▽=0	mm INCH	IN/MM	4:1	METRIC	
	▽=0	4 PLACES ± --- ± ---	DRAWN BY DATE	TITLE		
	▽=0	3 PLACES ± --- ±.015	POLGAR 1993/02/01	MINI-FIT JR. SINGLE ROW HEADER WITH MF/BL AND VOIDED CIRCUITS OPTION		
	▽=0	2 PLACES ± 0.38 ± ---	CHECKED BY DATE	molex DOCUMENT NO. SDA-43232-* SHEET NO. 3 OF 3		
	1 PLACE ± --- ± ---	FRY 1993/02/01				
	0 PLACE ± ±	APPROVED BY DATE	THIS DRAWING CONTAINS INFORMATION THAT IS PROPRIETARY TO MOLEX INCORPORATED AND SHOULD NOT BE USED WITHOUT WRITTEN PERMISSION			
		FSMITH 2011/06/21				

Mouser Electronics

Authorized Distributor

Click to View Pricing, Inventory, Delivery & Lifecycle Information:

[Molex:](#)

[43232-0004](#)