

25 W + 25 W stereo amplifier with mute and standby

Features

- Wide supply voltage range (up to ± 22.5 V)
- Split supply
- High output power
 - 25 W + 25 W into 8 Ω
 - with $V_S = \pm 20$ V and THD = 10%
- No “pop” at turn on/off
- Mute (“pop”-free)
- Standby feature (low I_Q)
- Few external components
- Short-circuit protection
- Thermal overload protection

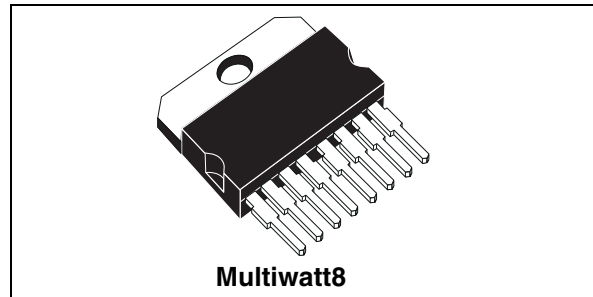

Description

The TDA7264 is class-AB dual audio power amplifier assembled in a Multiwatt package.

It is specially designed for high-quality sound applications such as hi-fi music centers and stereo TV sets.

Table 1. Device summary

Order code	Operating temperature	Package	Packaging
TDA7264	0 to 70 °C	Multiwatt8	Tube

Figure 1. Applications circuit

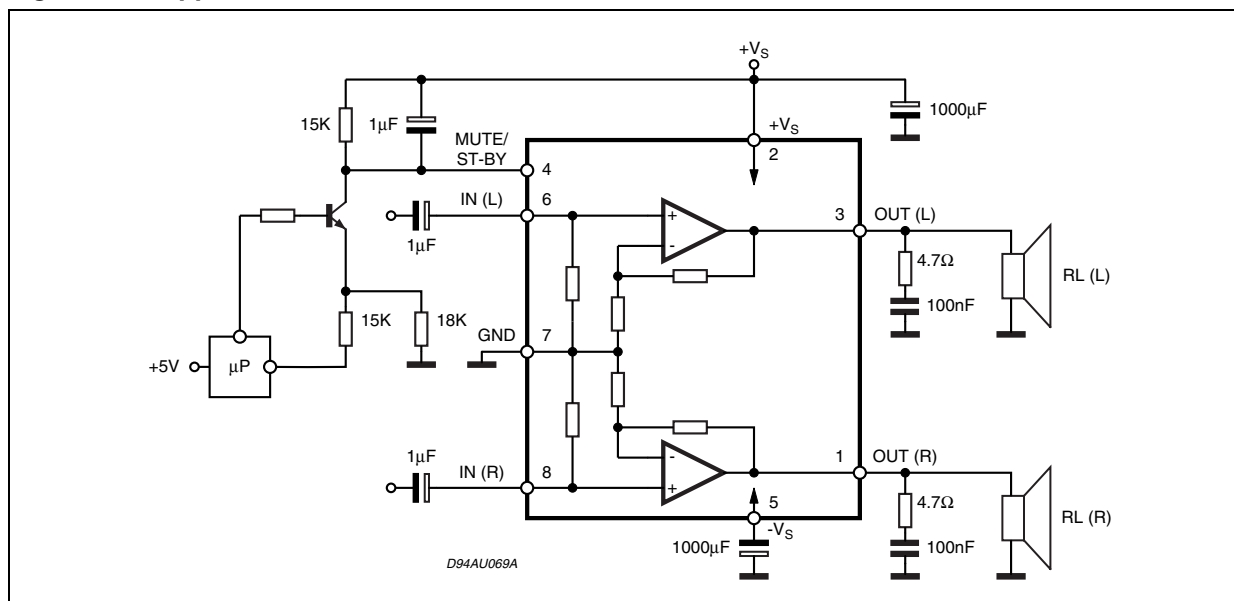

1 Pin description

Figure 2. Pin connection (top view)

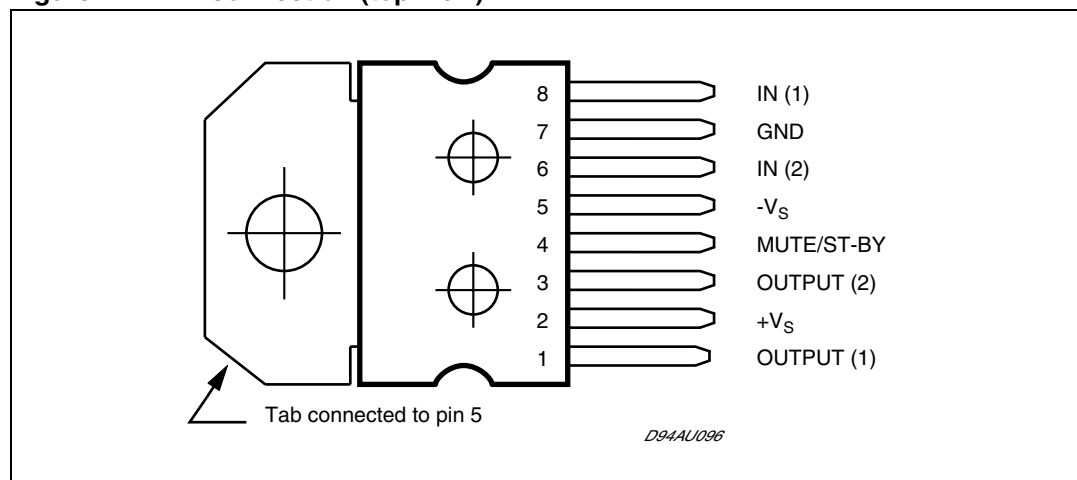

2 Electrical specifications

2.1 Absolute maximum ratings

Table 2. Absolute maximum ratings

Symbol	Parameter	Value	Unit
V_S	DC supply voltage	± 25	V
I_O	Output Peak Current (internally limited)	4.5	A
P_{tot}	power Dissipation $T_{case} = 70^\circ\text{C}$	30	W
T_{op}	Operating temperature	-20 to 85	$^\circ\text{C}$
T_j	Junction temperature	-40 to 150	$^\circ\text{C}$
T_{stg}	Storage temperature	-40 to 150	$^\circ\text{C}$

2.2 Thermal data

Table 3. Thermal data

Symbol	Parameter	Min	Typ	Max	Unit
$R_{th\ j-case}$	Thermal resistance, junction to case	-	-	2	$^\circ\text{C/W}$

2.3 Electrical specifications

Unless otherwise stated, the results in [Table 4](#) below are given for the conditions: $V_S = \pm 20\text{ V}$, R_L (load) = 8 Ω , R_S (source) = 50 Ω , $f = 1\text{ kHz}$, and $T_{amb} = 25^\circ\text{C}$. See also the applications circuit in [Figure 12 on page 9](#).

Table 4. Electrical specifications

Symbol	Parameter	Conditions	Min	Typ	Max	Unit
V_S	Supply voltage range	-	± 5	-	± 22.5	V
I_q	Total quiescent current	-	-	80	130	mA
P_{OM}	Music output power ⁽¹⁾	THD = 10%, $R_L = 8\ \Omega$, $V_S = \pm 22.5\text{ V}$	-	32	-	W
P_O	Output power	THD = 10%: $R_L = 8\ \Omega$, $V_S = \pm 20\text{ V}$ $R_L = 4\ \Omega$, $V_S = \pm 16\text{ V}$	20	25 25	-	W
		THD = 1%: $R_L = 8\ \Omega$, $V_S = \pm 20\text{ V}$ $R_L = 4\ \Omega$, $V_S = \pm 16\text{ V}$	-	20 20	-	

Table 4. Electrical specifications (continued)

Symbol	Parameter	Conditions	Min	Typ	Max	Unit
THD	Total harmonic distortion	$P_O = 1\text{ W}$, $f = 1\text{ kHz}$, $R_L = 8\ \Omega$, $V_S = \pm 20\text{ V}$,	-	0.02	-	%
		$P_O = 0.1\text{ to }15\text{ W}$, $f = 100\text{ Hz to }15\text{ kHz}$, $R_L = 8\ \Omega$, $V_S = \pm 20\text{ V}$	-	-	0.5	
		$P_O = 1\text{ W}$, $f = 1\text{ kHz}$, $R_L = 4\ \Omega$, $V_S = \pm 16\text{ V}$,	-	0.03	-	
		$P_O = 0.1\text{ to }12\text{ W}$, $f = 100\text{ Hz to }15\text{ kHz}$, $R_L = 4\ \Omega$, $V_S = \pm 16\text{ V}$	-	-	1.0	
C_T	Crosstalk	$f = 1\text{ kHz}$ $f = 10\text{ kHz}$	-	70 60	-	dB
SR	Slew rate	-	-	10	-	V/ μ s
G_V	Closed-loop voltage gain	-	29	30	31	dB
ΔG_V	Voltage gain matching	-	-	0.2	-	dB
eN	Total input noise	A curve $f = 20\text{ Hz to }22\text{ kHz}$	- -	2.5 3.5	8 -	μ V
R_i	Input resistance	-	15	20	-	k Ω
SVRR	Supply voltage rejection ratio	$f_r = 100\text{ Hz}$, $V_r = 0.5\text{ V}$	-	60	-	dB
T_j	Junction temperature at thermal shut-down	-	-	145	-	$^{\circ}$ C
Mute mode (see also Table 5 on page 8)						
V_{T_MUTE}	Mute/play threshold	-	-7	-6	-5	V
A_{MUTE}	Mute attenuation	-	60	90	-	dB
Standby mode (see also Table 5 on page 8)						
V_{T_STBY}	Standby/mute threshold	-	-3.5	-2.5	-1.5	V
A_{STBY}	Standby attenuation	-	-	110	-	dB
I_{q_STBY}	Quiescent current in standby	-	-	3	-	mA

1. FULL POWER up to $V_S = \pm 22.5\text{ V}$ with $R_L = 8\ \Omega$ and $V_S = \pm 16\text{ V}$ with $R_L = 4\ \Omega$.
MUSIC POWER is the maximum power which the amplifier is capable of producing across the rated load resistance (regardless of non-linearity) 1 s after the application of a sinusoidal input signal of frequency 1 kHz.

3 Characterization curves

Figure 3. Quiescent current vs Supply Voltage

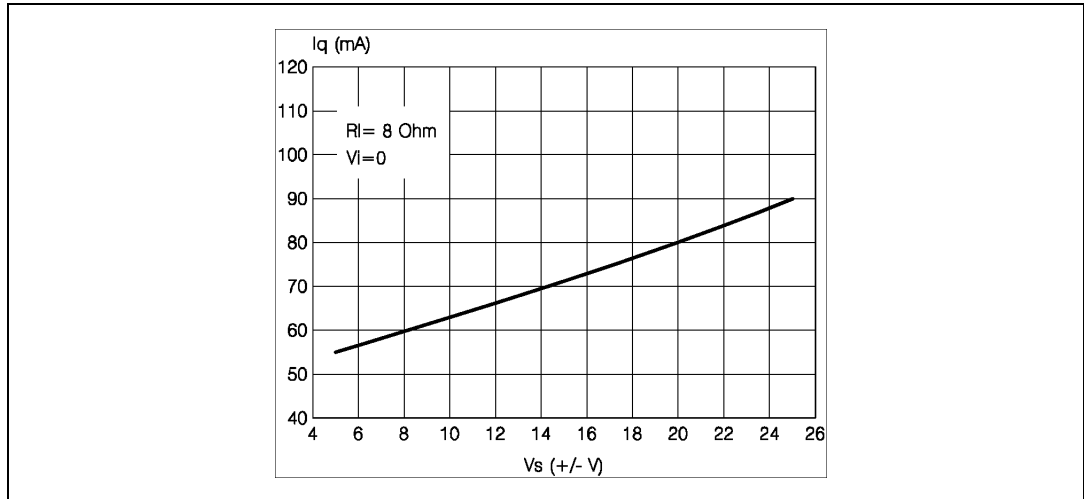

Figure 4. Frequency response

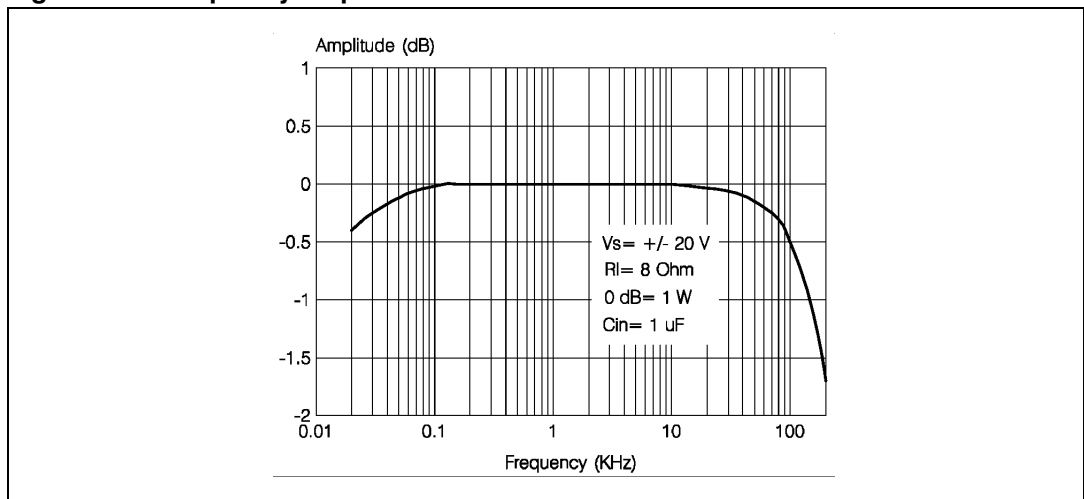

Figure 5. Output power vs supply voltage

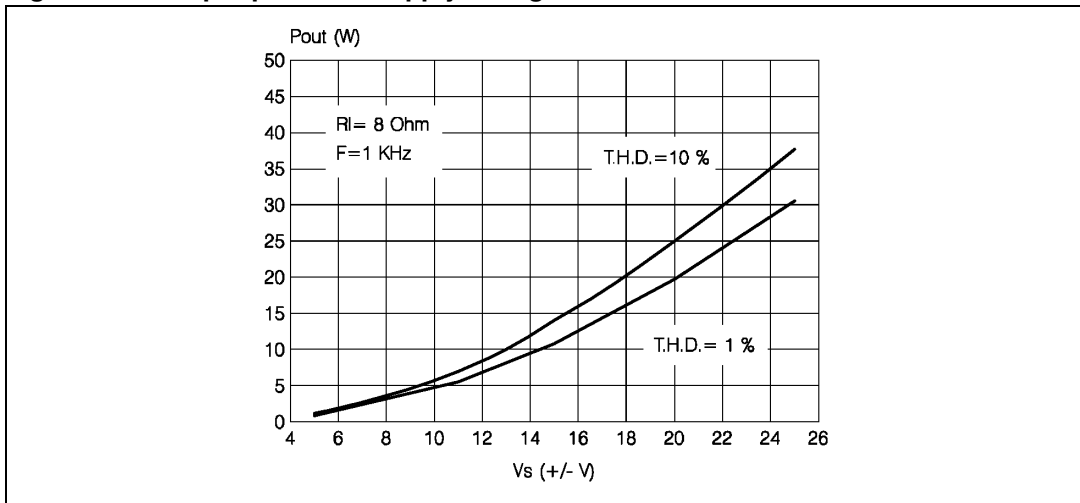

Figure 6. Distortion vs output power

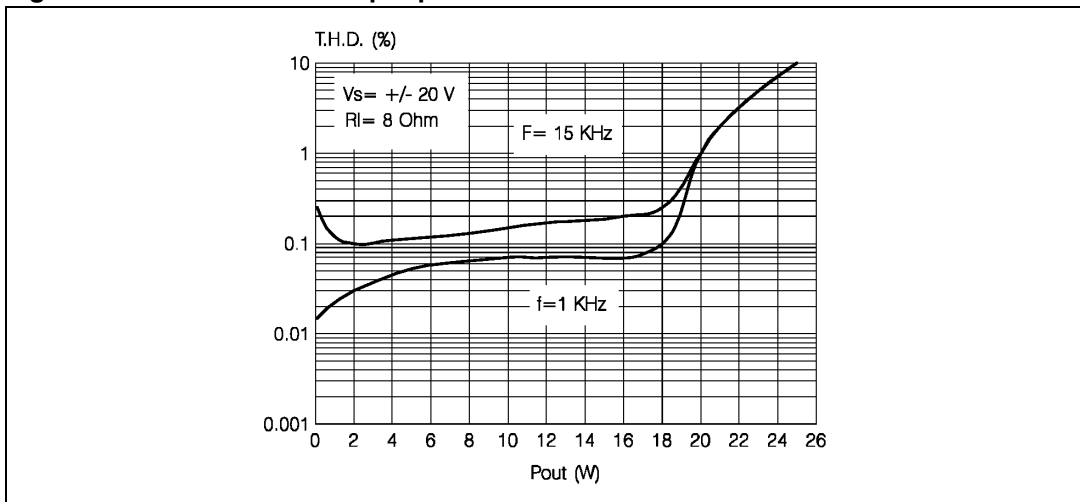

Figure 7. Crosstalk vs frequency

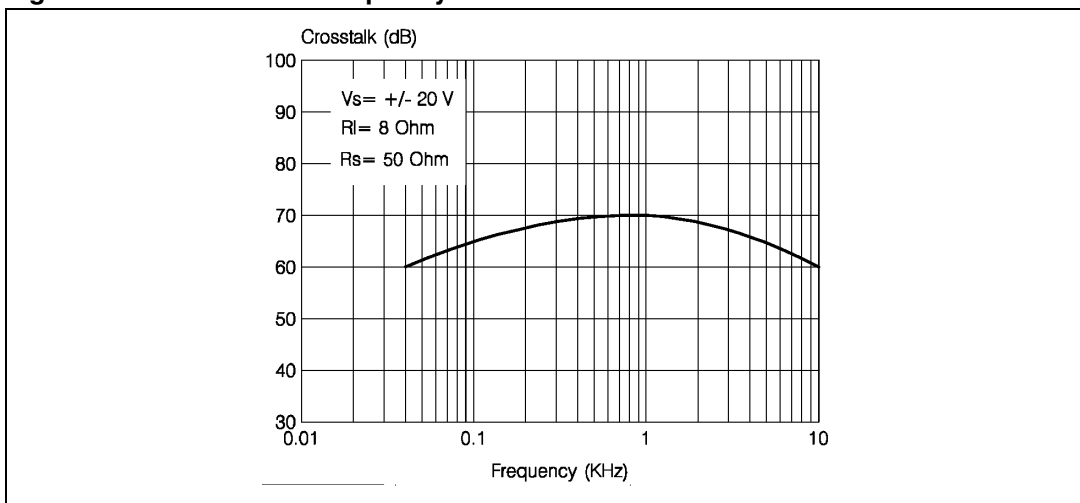

Figure 8. SVRR vs frequency

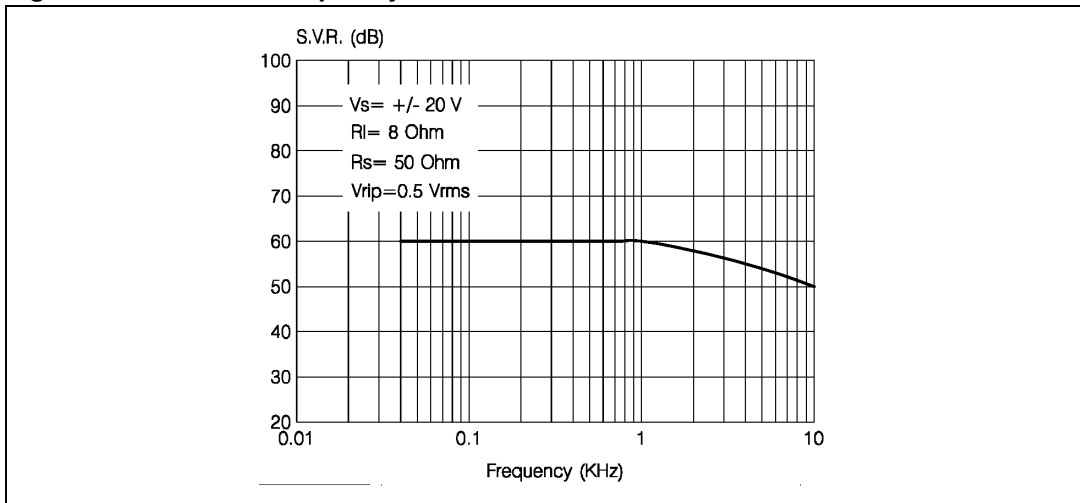

Figure 9. Attenuation and quiescent current vs voltage on pin 4

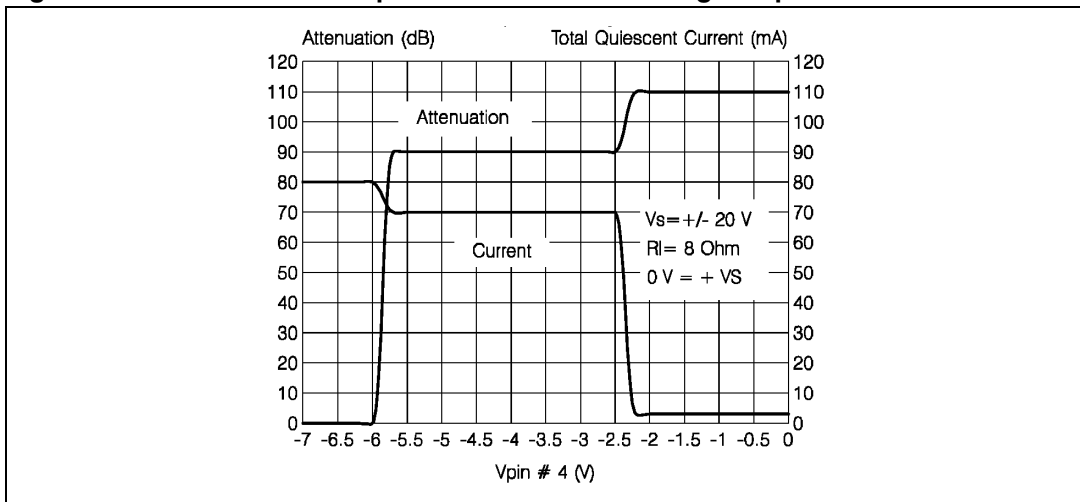
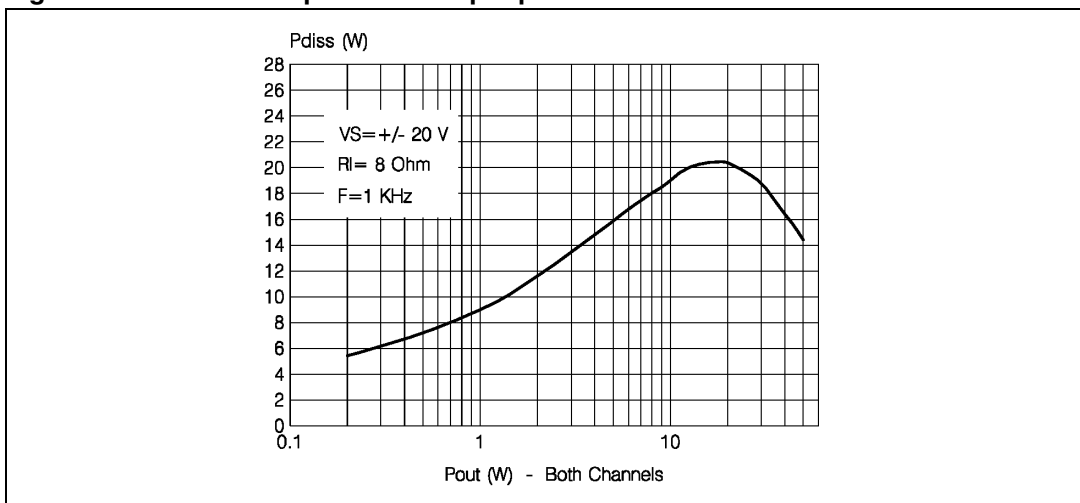

Figure 10. Power dissipation vs output power



4 Mute and standby modes

Pin 4 (MUTE/STANDBY) controls the amplifier status by two different thresholds referenced to $+V_S$ as given in [Table 5](#) below. See also [Table 4: Electrical specifications on page 3](#).

Table 5. Mute and standby thresholds on pin 5

Nominal voltage on pin 4, V_{PIN4}	Mode	Remarks
$> +V_S - 2.5\text{ V}$	Standby	Output stages turned off
$> +V_S - 6.0\text{ V}, < +V_S - 2.5\text{ V}$	Mute	Output stages turned on, amplifiers muted
$< +V_S - 6.0\text{ V}$	Play	Amplifiers active

Figure 11. Mute and standby thresholds on pin 4

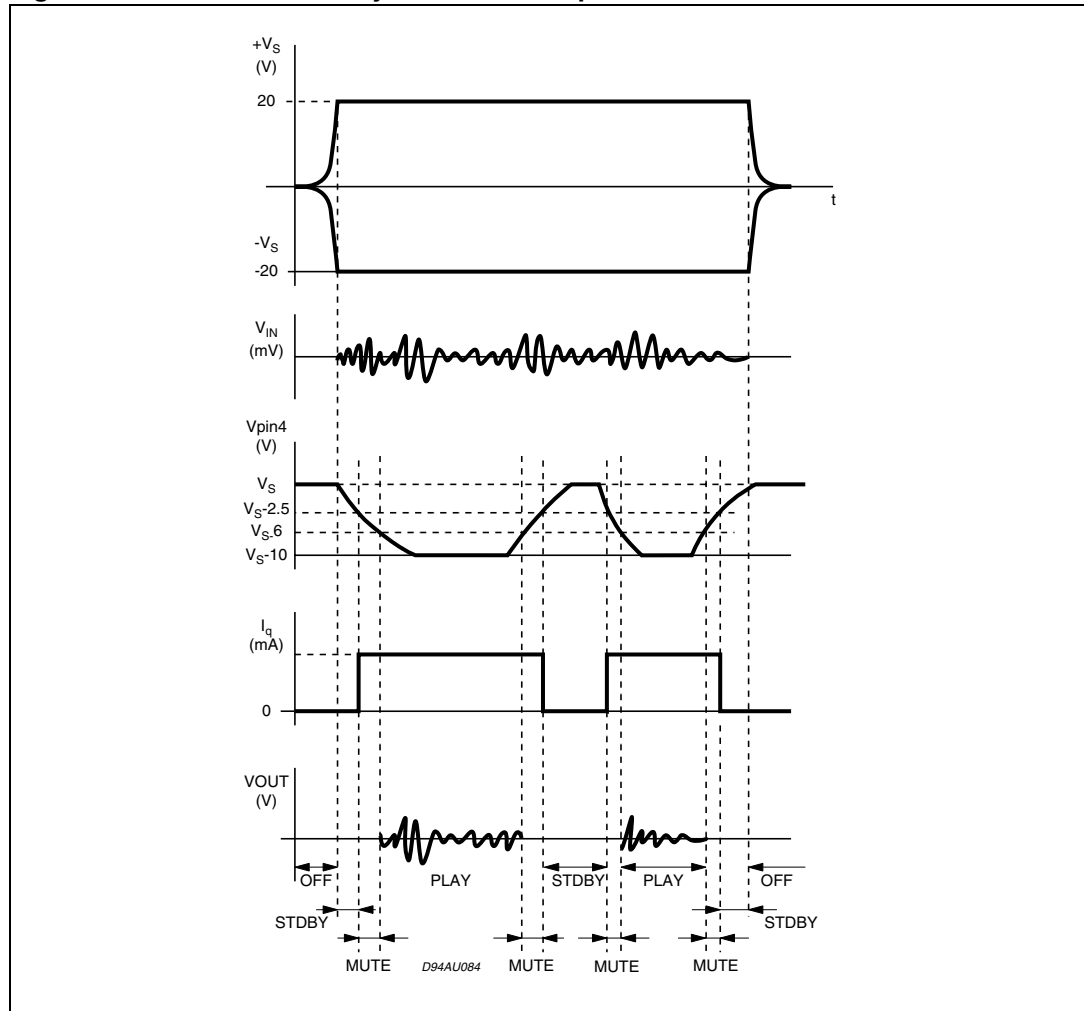

5 Applications information

Figure 12. Schematic of demo board

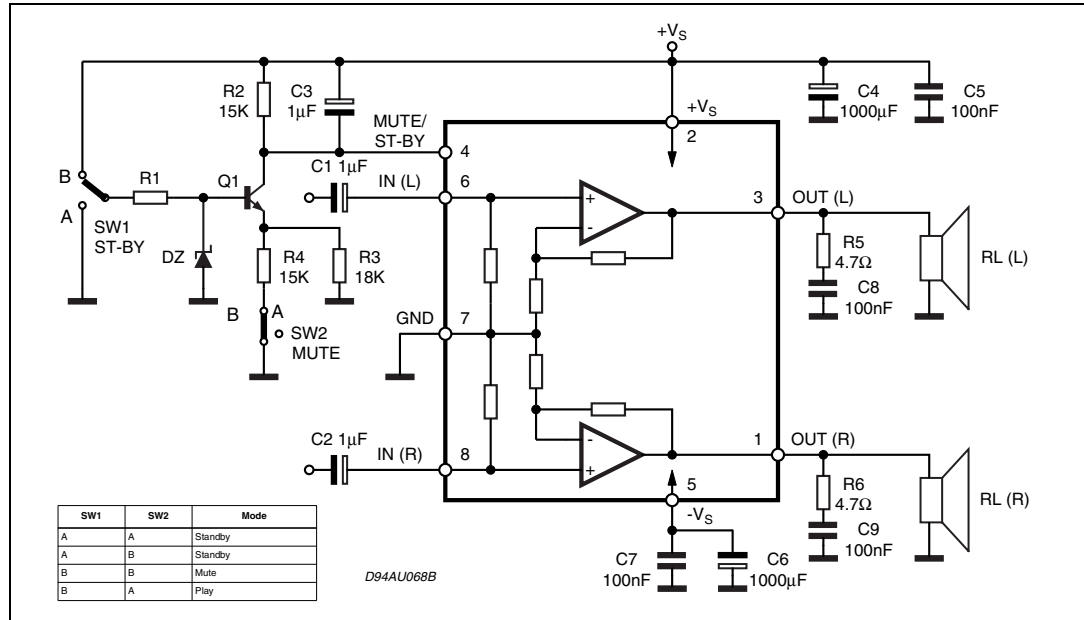

Figure 13. Component layout of demo-board

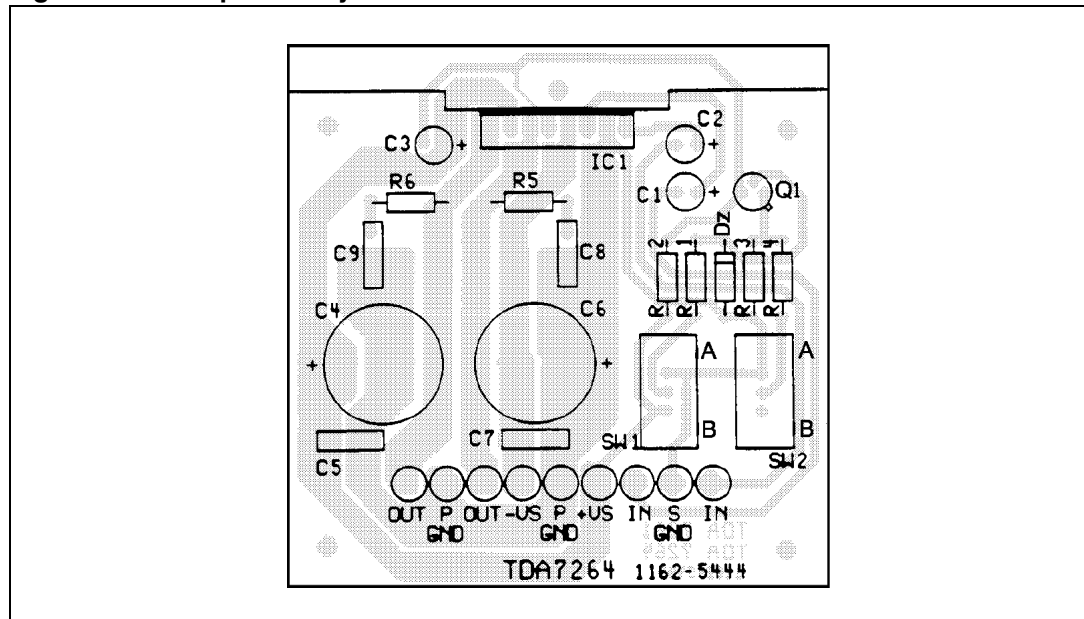

Table 6. Recommended component values for demo board

Component	Recommended value	Purpose	Larger than recommended value	Smaller than recommended value
R1	10 k Ω	Mute circuit	Decrease in DZ biasing current	-
R2	15 k Ω	Mute circuit	V _{PIN4} shifted downwards	V _{PIN4} shifted upwards
R3	18 k Ω	Mute circuit	V _{PIN4} shifted upwards	V _{PIN4} shifted downwards
R4	15 k Ω	Mute circuit	V _{PIN4} shifted upwards	V _{PIN4} shifted downwards
R5, R6	4.7 Ω	Frequency stability	Danger of oscillation	Danger of oscillation
C1, C2	1 μ F	Input AC coupling	-	Higher low-frequency cutoff
C3	1 μ F	Standby/mute time constant	Longer on/off time	Shorter on/off time
C4, C6	1000 μ F	Supply voltage decoupling	-	Danger of oscillation
C5, C7	0.1 μ F	Supply voltage decoupling	-	Danger of oscillation
C8, C9	0.1 μ F	Frequency stability	-	-
Dz	5.1 V	Mute circuit	-	-
Q1	BC107	Mute circuit	-	-

6 Package mechanical data

The TDA7264 comes in a 8-pin Multiwatt package with pin 5 internally connected to the metal tab.

Figure 14. Multiwatt8 outline drawing

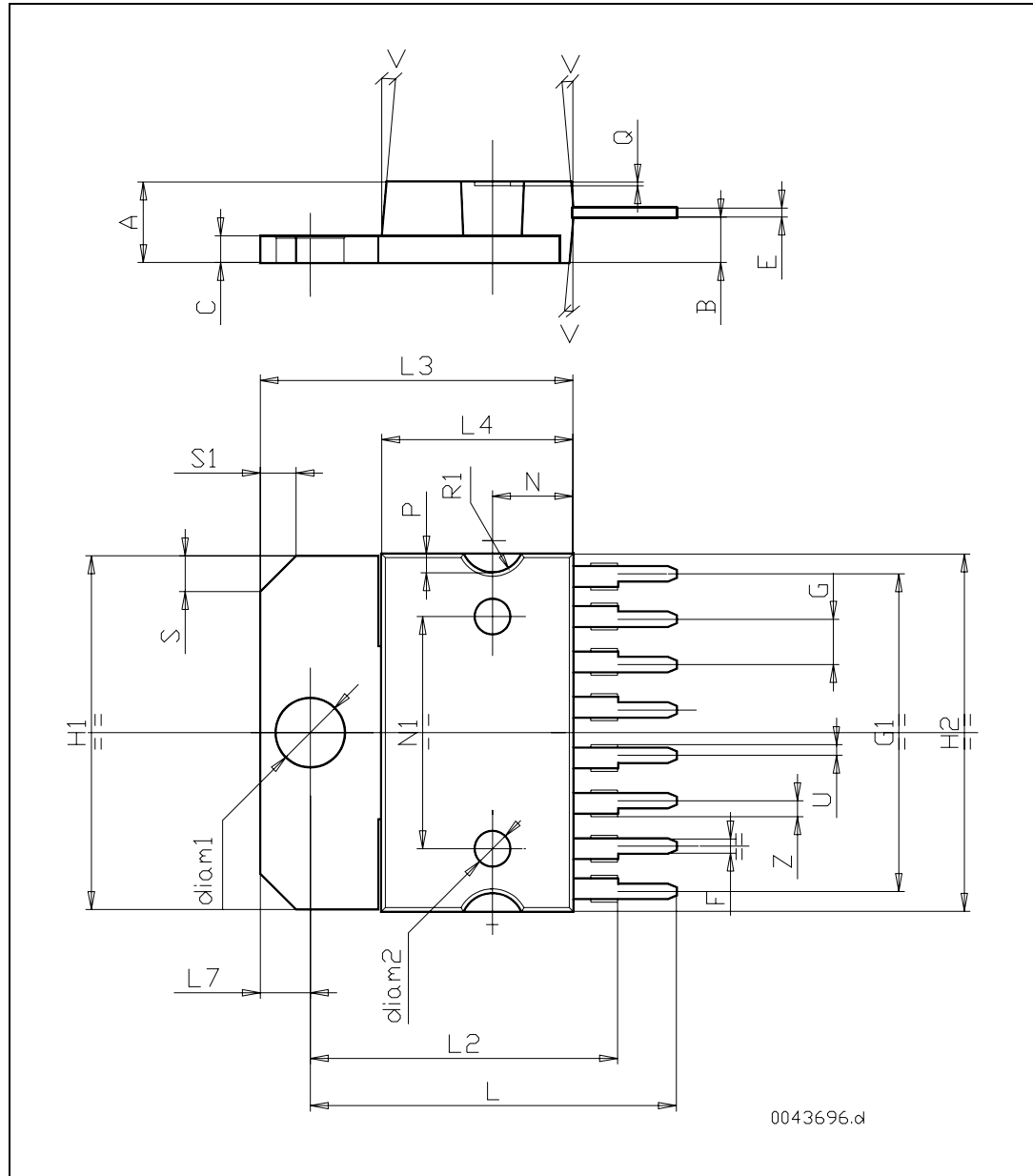

In order to meet environmental requirements, ST offers these devices in different grades of ECOPACK® packages, depending on their level of environmental compliance. ECOPACK® specifications, grade definitions and product status are available at: www.st.com. ECOPACK® is an ST trademark.

Table 7. Multiwatt8 package dimensions

Reference	Dimensions in mm			Dimensions in inches		
	Min	Typ	Max	Min	Typ	Max
A	-	-	5.00	-	-	0.197
B	-	-	2.65	-	-	0.104
C	-	-	1.60	-	-	0.063
E	0.49	-	0.55	0.019	-	0.22
F	0.78	-	0.85	0.031	-	0.033
G	2.40	2.54	2.68	0.094	0.100	0.106
G1	17.64	17.78	17.92	0.694	0.700	0.706
H1	19.60	-	-	0.772	-	-
H2	-	-	20.20	-	-	0.787
L	20.35	-	20.65	0.801	-	0.813
L2	17.05	17.20	17.35	0.671	0.677	0.683
L3	17.25	17.50	17.75	0.679	0.689	0.699
L4	10.30	10.70	10.90	0.406	0.421	0.429
L7	2.65	-	2.90	0.104	-	0.114
N	-	-	-	-	-	-
N1	-	-	-	-	-	-
P	-	-	-	-	-	-
Q	-	-	-	-	-	-
R1	-	-	-	-	-	-
S	1.90	-	2.60	0.075	-	0.102
S1	1.90	-	2.60	0.075	-	0.102
U	0.40	-	0.55	0.016	-	0.022
V	-	5 deg	-	-	5 deg	-
Z	0.70	-	0.85	-	-	0.033
Diam.1	3.65	-	3.85	0.144	-	0.152
Diam.2	-	-	-	-	-	-

7 Revision history

Table 8. Document revision history

Date	Revision	Changes
Jan-2004	5	First issue in EDOCS
01-Jul-2009	6	Removed references to TDA7264A

Please Read Carefully:

Information in this document is provided solely in connection with ST products. STMicroelectronics NV and its subsidiaries ("ST") reserve the right to make changes, corrections, modifications or improvements, to this document, and the products and services described herein at any time, without notice.

All ST products are sold pursuant to ST's terms and conditions of sale.

Purchasers are solely responsible for the choice, selection and use of the ST products and services described herein, and ST assumes no liability whatsoever relating to the choice, selection or use of the ST products and services described herein.

No license, express or implied, by estoppel or otherwise, to any intellectual property rights is granted under this document. If any part of this document refers to any third party products or services it shall not be deemed a license grant by ST for the use of such third party products or services, or any intellectual property contained therein or considered as a warranty covering the use in any manner whatsoever of such third party products or services or any intellectual property contained therein.

UNLESS OTHERWISE SET FORTH IN ST'S TERMS AND CONDITIONS OF SALE ST DISCLAIMS ANY EXPRESS OR IMPLIED WARRANTY WITH RESPECT TO THE USE AND/OR SALE OF ST PRODUCTS INCLUDING WITHOUT LIMITATION IMPLIED WARRANTIES OF MERCHANTABILITY, FITNESS FOR A PARTICULAR PURPOSE (AND THEIR EQUIVALENTS UNDER THE LAWS OF ANY JURISDICTION), OR INFRINGEMENT OF ANY PATENT, COPYRIGHT OR OTHER INTELLECTUAL PROPERTY RIGHT.

UNLESS EXPRESSLY APPROVED IN WRITING BY AN AUTHORIZED ST REPRESENTATIVE, ST PRODUCTS ARE NOT RECOMMENDED, AUTHORIZED OR WARRANTED FOR USE IN MILITARY, AIR CRAFT, SPACE, LIFE SAVING, OR LIFE SUSTAINING APPLICATIONS, NOR IN PRODUCTS OR SYSTEMS WHERE FAILURE OR MALFUNCTION MAY RESULT IN PERSONAL INJURY, DEATH, OR SEVERE PROPERTY OR ENVIRONMENTAL DAMAGE. ST PRODUCTS WHICH ARE NOT SPECIFIED AS "AUTOMOTIVE GRADE" MAY ONLY BE USED IN AUTOMOTIVE APPLICATIONS AT USER'S OWN RISK.

Resale of ST products with provisions different from the statements and/or technical features set forth in this document shall immediately void any warranty granted by ST for the ST product or service described herein and shall not create or extend in any manner whatsoever, any liability of ST.

ST and the ST logo are trademarks or registered trademarks of ST in various countries.

Information in this document supersedes and replaces all information previously supplied.

The ST logo is a registered trademark of STMicroelectronics. All other names are the property of their respective owners.

© 2009 STMicroelectronics - All rights reserved

STMicroelectronics group of companies

Australia - Belgium - Brazil - Canada - China - Czech Republic - Finland - France - Germany - Hong Kong - India - Israel - Italy - Japan - Malaysia - Malta - Morocco - Philippines - Singapore - Spain - Sweden - Switzerland - United Kingdom - United States of America

www.st.com

Mouser Electronics

Authorized Distributor

Click to View Pricing, Inventory, Delivery & Lifecycle Information:

[STMicroelectronics:](#)

[TDA7264](#)