

DS90C032QML LVDS Quad CMOS Differential Line Receiver

 Check for Samples: [DS90C032QML](#)

FEATURES

- **Single Event Latchup (SEL) Immune 120 MeV-cm²/mg**
- **High Impedance LVDS Inputs with Power-Off.**
- **Accepts Small Swing (330 mV) Differential Signal Levels**
- **Low Power Dissipation**
- **Low Differential Skew**
- **Low Chip to Chip Skew**
- **Pin Compatible with DS26C32A**
- **Compatible with IEEE 1596.3 SCI LVDS Standard**

DESCRIPTION

The DS90C032 is a quad CMOS differential line receiver designed for applications requiring ultra low power dissipation and high data rates.

The DS90C032 accepts low voltage differential input signals and translates them to CMOS (TTL compatible) output levels. The receiver supports a TRI-STATE function that may be used to multiplex outputs. The receiver also supports OPEN Failsafe and terminated (100Ω) input Failsafe with the addition of external failsafe biasing. Receiver output will be HIGH for both Failsafe conditions.

The DS90C032 provides power-off high impedance LVDS inputs. This feature assures minimal loading effect on the LVDS bus lines when VCC is not present.

The DS90C032 and companion line driver (DS90C031) provide a new alternative to high power pseudo-ECL devices for high speed point-to-point interface applications.

Connection Diagrams

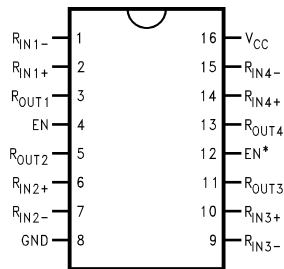

Figure 1. Dual-In-Line
See Package Number NAD0016A & NAC0016A

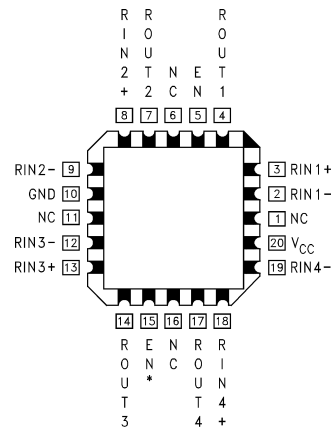

Figure 2. LCCC Package
See Package Number NAJ0020A



Please be aware that an important notice concerning availability, standard warranty, and use in critical applications of Texas Instruments semiconductor products and disclaimers thereto appears at the end of this data sheet.

All trademarks are the property of their respective owners.

Functional Diagram and Truth Table

Block Diagram

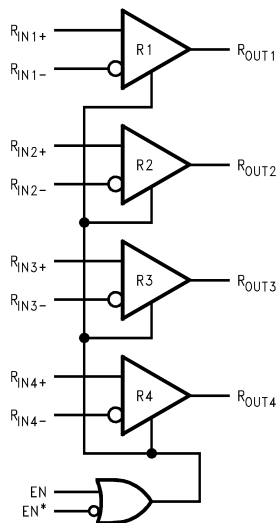

Receiver

ENABLES		INPUTS	OUTPUT
EN	EN*	$R_{I+} - R_{I-}$	R_O
L	H	X	Z
All other combinations of ENABLE inputs		$V_{ID} \geq 0.1V$	H
		$V_{ID} \leq -0.1V$	L



These devices have limited built-in ESD protection. The leads should be shorted together or the device placed in conductive foam during storage or handling to prevent electrostatic damage to the MOS gates.

Absolute Maximum Ratings⁽¹⁾

Supply Voltage (V_{CC})	-0.3V to +6V
Input Voltage (R_{I+} , R_{I-})	-0.3V to +5.8V
Enable Input Voltage (EN , EN^*)	-0.3V to ($V_{CC} + 0.3V$)
Output Voltage (R_O)	-0.3V to ($V_{CC} + 0.3V$)
Storage Temperature Range (T_{Stg})	$-65^{\circ}C \leq T_A \leq +150^{\circ}C$
Maximum Lead Temperature, Soldering (4 seconds)	+260°C
Maximum Package Power Dissipation at +25°C ⁽²⁾	
LCCC Package	1830 mW
CLGA (NAD)	1400 mW
CLGA (NAC)	1400 mW
Thermal Resistance	
θ_{JA}	
LCCC Package	82°C/W
CLGA (NAD)	145°C/W
CLGA (NAC)	145°C/W
θ_{JC}	
LCCC Package	20°C/W
CLGA (NAD)	20°C/W
CLGA (NAC)	20°C/W
ESD Rating ⁽³⁾	2KV

(1) Absolute Maximum Ratings indicate limits beyond which damage to the device may occur. Operating Ratings indicate conditions for which the device is functional, but do not ensure specific performance limits. For ensured specifications and test conditions, see the Electrical Characteristics. The ensured specifications apply only for the test conditions listed. Some performance characteristics may degrade when the device is not operated under the listed test conditions.

(2) Derate LCCC at 12.2mW/°C above +25°C. Derate CLGA at 6.8mW/°C above +25°C

(3) Human body model, 1.5 k Ω in series with 100 pF.

Recommended Operating Conditions

	Min	Typ	Max
Supply Voltage (V_{CC})	+4.5V	+5.0V	+5.5V
Receiver Input Voltage	Gnd		2.4V
Operating Free Air Temperature (T_A)	-55°C	+25°C	+125°C

Quality Conformance Inspection**Table 1. Mil-Std-883, Method 5005 - Group A**

Subgroup	Description	Temp (°C)
1	Static tests at	+25
2	Static tests at	+125
3	Static tests at	-55
4	Dynamic tests at	+25
5	Dynamic tests at	+125
6	Dynamic tests at	-55
7	Functional tests at	+25
8A	Functional tests at	+125
8B	Functional tests at	-55
9	Switching tests at	+25
10	Switching tests at	+125
11	Switching tests at	-55
12	Settling time at	+25
13	Settling time at	+125
14	Settling time at	-55

DS90C032 Electrical Characteristics, DC Parameters⁽¹⁾

Symbol	Parameter	Conditions	Notes	Min	Max	Units	Sub-groups
V _{ThL}	Differential Input Low Threshold	V _{CM} = +1.2V	See ⁽²⁾		-100	mV	1, 2, 3
V _{ThH}	Differential Input High Threshold	V _{CM} = +1.2V	See ⁽²⁾		100	mV	1, 2, 3
I _{in}	Input Current (Input Pins)	V _{CC} =5.5V, V _I = 2.4V			±10	µA	1, 2, 3
		V _{CC} = 5.5V, V _I = 0			±10	µA	1, 2, 3
		V _{CC} = 0.0V, V _I = 2.4V			±10	µA	1, 2, 3
		V _{CC} = 0.0V, V _I = 0.0V			±10	µA	1, 2, 3
V _{OH}	Output High Voltage	V _{CC} = 4.5V, I _{OH} = -0.4 mA, V _{ID} = 200mV		3.8		V	1, 2, 3
V _{OL}	Output Low Voltage	V _{CC} = 4.5, I _{OL} = 2 mA, V _{ID} = -200mV			0.3	V	1, 2, 3
I _{OS}	Output Short Circuit Current	Enabled, V _O = 0V		-15	-100	mA	1, 2, 3
I _{OZ}	Output TRI-STATE Current	Disabled, V _O = 0V or V _{CC}			±10	µA	1, 2, 3
V _{IH}	Input High Voltage		See ⁽²⁾	2.0		V	1, 2, 3
V _{IL}	Input Low Voltage		See ⁽²⁾		0.8	V	1, 2, 3
I _I	Input Current (Enable Pins)	V _{CC} = 5.5V			±10	µA	1, 2, 3
V _{CL}	Input Clamp Voltage	I _{Cl} = -18mA			-1.5	V	1, 2, 3
I _{CC}	No Load Supply Current	EN, EN* = V _{CC} or Gnd, Inputs Open			11	mA	1, 2, 3
		EN, EN* = 2.4 or 0.5, Inputs Open			11	mA	1, 2, 3
I _{CCZ}	No Load Supply Current Receivers Disabled	EN = Gnd, EN* = V _{CC} , Inputs Open			11	mA	1, 2, 3

(1) Pre and post irradiation limits are identical to those listed under AC and DC electrical characteristics except as listed in the "Post Radiation Limits" table. Radiation end point limits for the noted parameters are ensured only for the conditions, as specified.

(2) Tested during V_{OH} and V_{OL} tests.

DS90C032 Electrical Characteristics, AC Parameters⁽¹⁾

The following conditions apply, unless otherwise specified.

AC: $V_{CC} = 4.5V / 5.0V / 5.5V$, $C_L = 20pF$

Symbol	Parameter	Conditions	Notes	Min	Max	Units	Sub-groups
t_{PHLD}	Differential Propagation Delay High to Low	$V_{ID} = 200mV$, Input pulse = 1.1V to 1.3V, $V_I = 1.2V$ (0V differential) to $V_O = 1/2 V_{CC}$		1.0	8.0	ns	9, 10, 11
t_{PLHD}	Differential Propagation Delay Low to High	$V_{ID} = 200mV$, Input pulse = 1.1V to 1.3V, $V_I = 1.2V$ (0V differential) to $V_O = 1/2 V_{CC}$		1.0	8.0	ns	9, 10, 11
t_{SKD}	Differential Skew $ t_{PHLD} - t_{PLHD} $	$C_L = 20pF$, $V_{ID} = 200mV$			3.0	ns	9, 10, 11
t_{SK1}	Channel to Channel Skew	$C_L = 20pF$, $V_{ID} = 200mV$	See ⁽²⁾		3.0	ns	9, 10, 11
t_{SK2}	Chip to Chip Skew	$C_L = 20pF$, $V_{ID} = 200mV$	See ⁽³⁾		7.0	ns	9, 10, 11
t_{PLZ}	Disable Time Low to Z	Input pulse = 0V to 3.0V, $V_O = V_{OL} + 0.5V$, $R_L = 1K\Omega$ to V_{CC} , $V_I = 1.5V$			20	ns	9, 10, 11
t_{PHZ}	Disable Time High to Z	Input pulse = 0V to 3.0V, $V_I = 1.5V$, $V_O = V_{OH} - 0.5V$, $R_L = 1K\Omega$ to Gnd			20	ns	9, 10, 11
t_{PZH}	Enable Time Z to High	Input pulse = 0V to 3.0V, $V_I = 1.5V$, $V_O = 50\%$, $R_L = 1K\Omega$ to Gnd			20	ns	9, 10, 11
t_{PZL}	Enable Time Z to Low	Input pulse = 0V to 3.0V, $V_I = 1.5V$, $V_O = 50\%$, $R_L = 1K\Omega$ to V_{CC}			20	ns	9, 10, 11

- (1) Pre and post irradiation limits are identical to those listed under AC and DC electrical characteristics except as listed in the "Post Radiation Limits" table. Radiation end point limits for the noted parameters are ensured only for the conditions, as specified.
- (2) Channel-to-Channel Skew is defined as the difference between the propagation delay of one channel and that of the others on the same chip with an event on the inputs.
- (3) Chip-to-Chip Skew is defined as the difference between the minimum and maximum specified differential propagation delays.

DS90C032 Electrical Characteristics, AC/DC Post Radiation Limits⁽¹⁾

Symbol	Parameter	Conditions	Notes	Min	Max	Units	Sub-groups
I_{CC}	No Load Supply Current	EN, EN* = V_{CC} or Gnd, Inputs Open			20	mA	1
		EN, EN* = 2.4 or 0.5, Inputs Open			20	mA	1
I_{CCZ}	No Load Supply Current Receivers Disabled	EN = Gnd, EN* = V_{CC} , Inputs Open			20	mA	1

- (1) Pre and post irradiation limits are identical to those listed under AC and DC electrical characteristics except as listed in the "Post Radiation Limits" table. Radiation end point limits for the noted parameters are ensured only for the conditions, as specified.

Parameter Measurement Information

Figure 3.

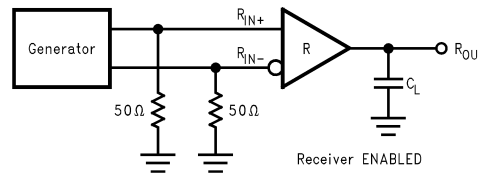

Figure 4. Receiver Propagation Delay and Transition Time Test Circuit

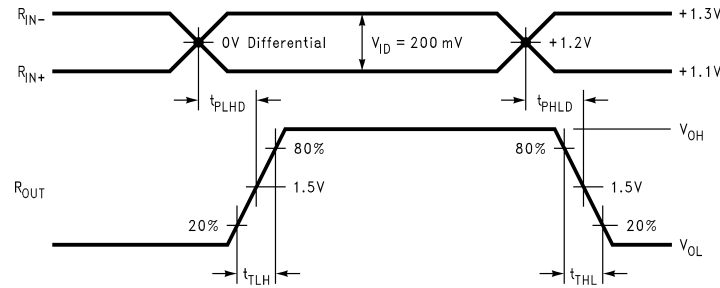
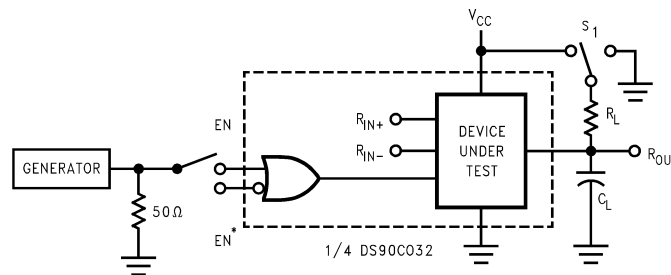

Figure 5. Receiver Propagation Delay and Transition Time Waveforms



- A. C_L includes load and test jig capacitance.
- B. $S_1 = V_{CC}$ for t_{PZL} and t_{PLZ} measurements.
- C. $S_1 = Gnd$ for t_{PZH} and t_{PHZ} measurements.

Figure 6. Receiver TRI-STATE Delay Test Circuit

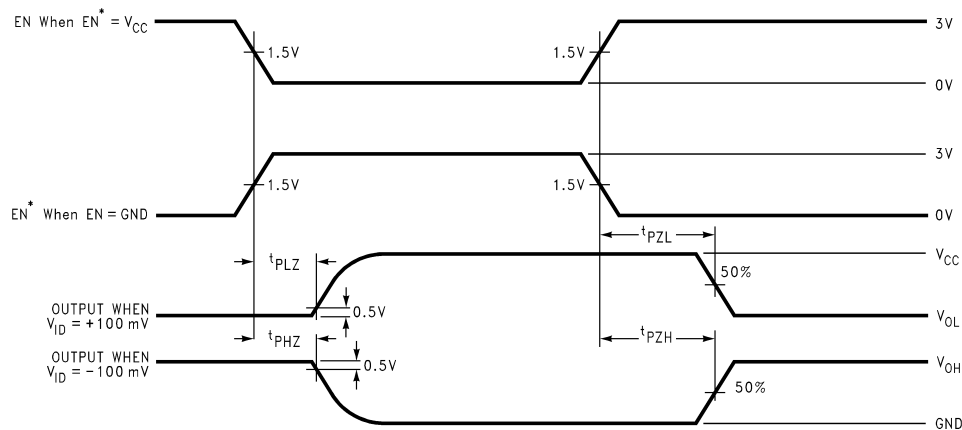

Figure 7. Receiver TRI-STATE Delay Waveforms

Typical Performance Characteristics

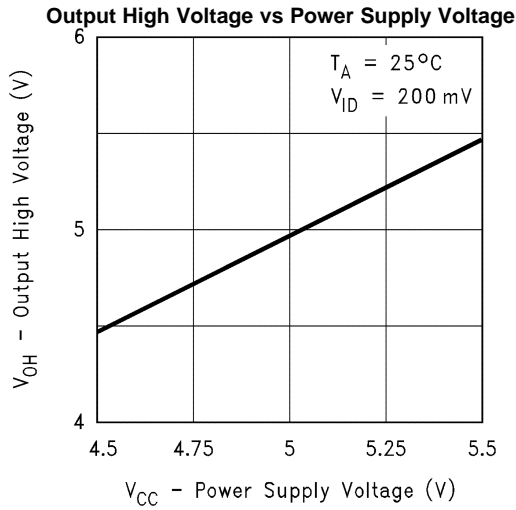

Figure 8.

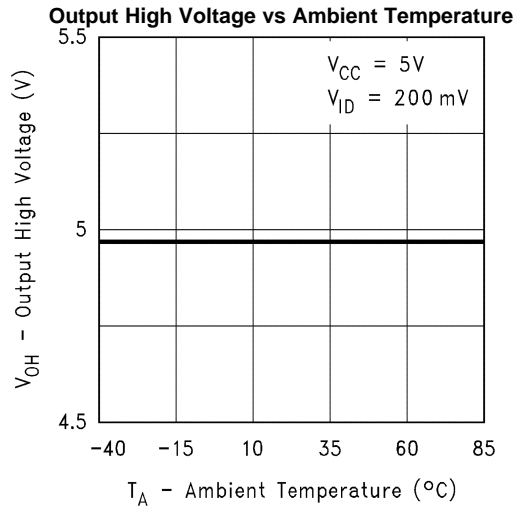

Figure 9.

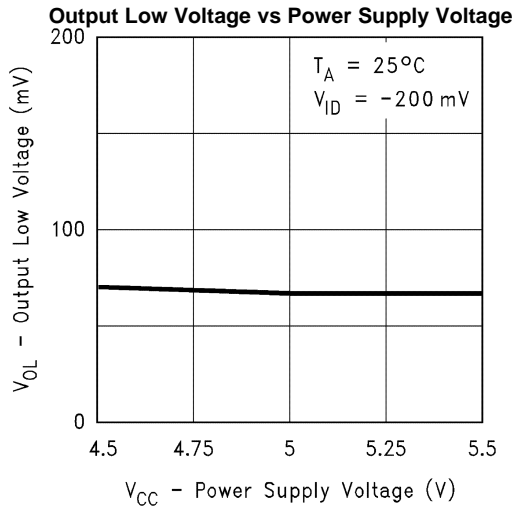

Figure 10.

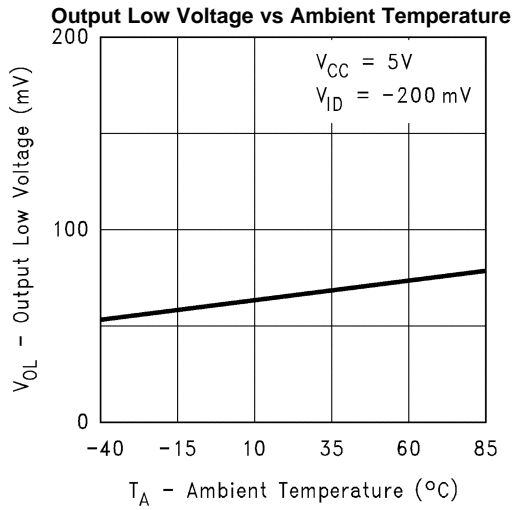

Figure 11.

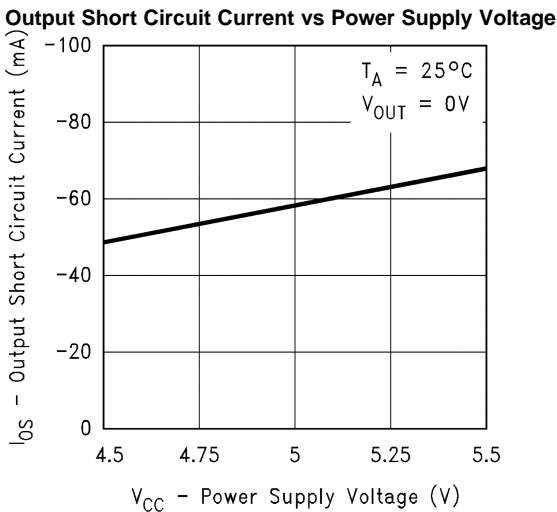

Figure 12.

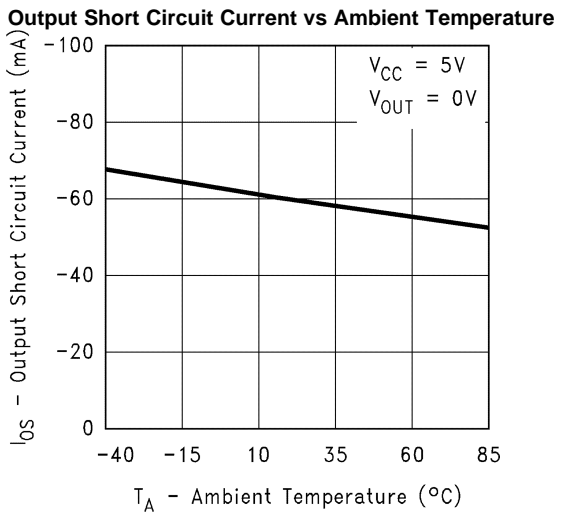

Figure 13.

Typical Performance Characteristics (continued)

Differential Propagation Delay vs Power Supply Voltage

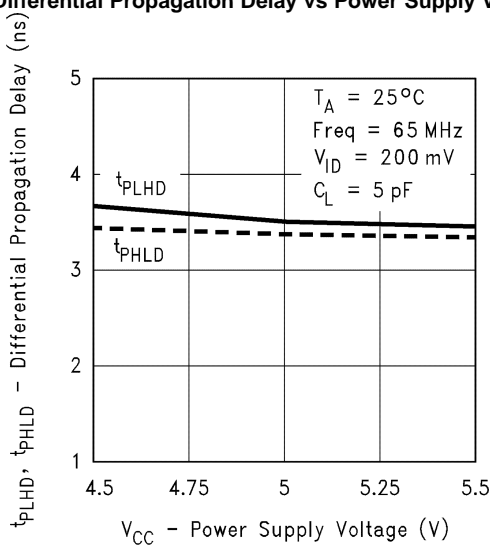

Figure 14.

Differential Propagation Delay vs Ambient Temperature

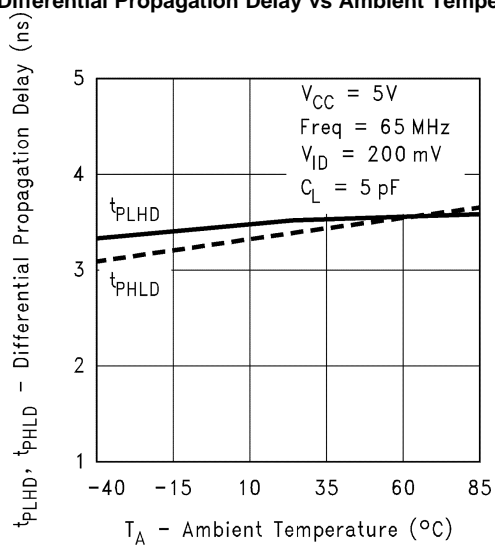

Figure 15.

Differential Skew vs Power Supply Voltage

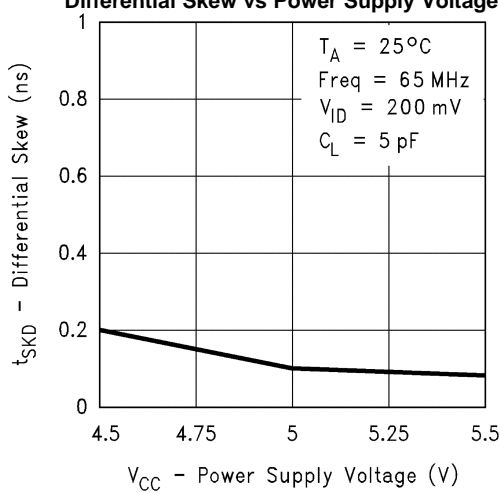

Figure 16.

Differential Skew vs Ambient Temperature

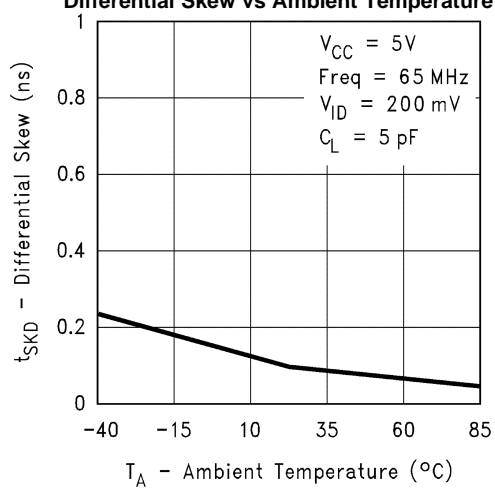

Figure 17.

Transition Time vs Power Supply Voltage

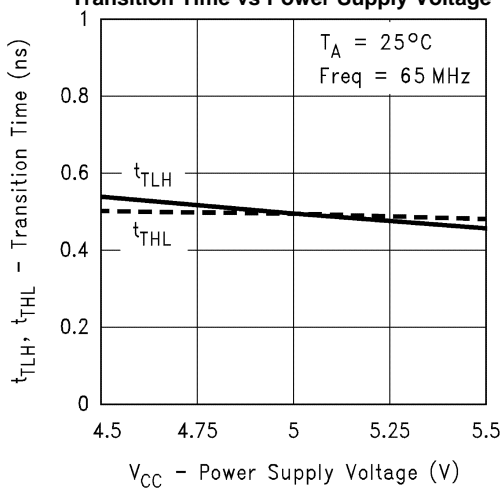

Figure 18.

Transition Time vs Ambient Temperature

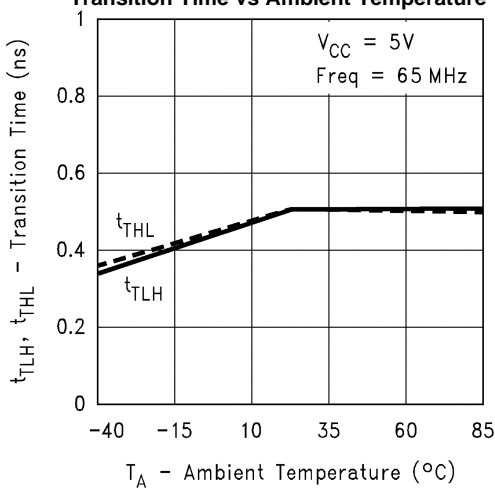

Figure 19.

TYPICAL APPLICATION

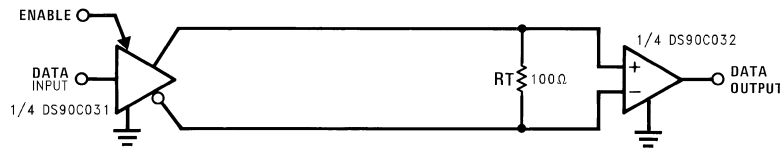

Figure 20. Point-to-Point Application

APPLICATIONS INFORMATION

LVDS drivers and receivers are intended to be primarily used in an uncomplicated point-to-point configuration as is shown in [Figure 20](#). This configuration provides a clean signaling environment for the quick edge rates of the drivers. The receiver is connected to the driver through a balanced media which may be a standard twisted pair cable, a parallel pair cable, or simply PCB traces. Typically the characteristic impedance of the media is in the range of 100Ω. A termination resistor of 100Ω should be selected to match the media, and is located as close to the receiver input pins as possible. The termination resistor converts the current sourced by the driver into a voltage that is detected by the receiver. Other configurations are possible such as a multi-receiver configuration, but the effects of a mid-stream connector(s), cable stub(s), and other impedance discontinuities as well as ground shifting, noise margin limits, and total termination loading must be taken into account.

The DS90C032 differential line receiver is capable of detecting signals as low as 100 mV, over a ±1V common-mode range centered around +1.2V. This is related to the driver offset voltage which is typically +1.2V. The driven signal is centered around this voltage and may shift ±1V around this center point. The ±1V shifting may be the result of a ground potential difference between the driver's ground reference and the receiver's ground reference, the common-mode effects of coupled noise, or a combination of the two. Both receiver input pins should honor their specified operating input voltage range of 0V to +2.4V (measured from each pin to ground), exceeding these limits may turn on the ESD protection circuitry which will clamp the bus voltages.

Receiver Failsafe

The LVDS receiver is a high gain, high speed device that amplifies a small differential signal (20mV) to CMOS logic levels. Due to the high gain and tight threshold of the receiver, care should be taken to prevent noise from appearing as a valid signal.

The receiver's internal failsafe circuitry is designed to source/sink a small amount of current, providing failsafe protection (a stable known state of HIGH output voltage) for floating and terminated (100Ω) receiver inputs in low noise environment (differential noise < 10mV).

- **Open Input Pins**

The DS90C032 is a quad receiver device, and if an application requires only 1, 2 or 3 receivers, the unused channel(s) inputs should be left OPEN. Do not tie unused receiver inputs to ground or any other voltages. The input is biased by internal high value pull up and pull down resistors to set the output to a HIGH state. This internal circuitry will ensure a HIGH, stable output state for open inputs.

- **Terminated Input**

The DS90C032 requires external failsafe biasing for terminated input failsafe.

Terminated input failsafe is the case of a receiver that has a 100Ω termination across its inputs and the driver is in the following situations. Unplugged from the bus, or the driver output is in TRI-STATE or in power-off condition. The use of external biasing resistors provide a small bias to set the differential input voltage while the line is un-driven, and therefore the receiver output will be in HIGH state. If the driver is removed from the bus but the cable is still present and floating, the unplugged cable can become a floating antenna that can pick up noise. The LVDS receiver is designed to detect very small amplitude and width signals and recover them to standard logic levels. Thus, if the cable picks up more than 10mV of differential noise, the receiver may respond. To insure that any noise is seen as commonmode and not differential, a balanced interconnect and twisted pair cables is recommended, as they help to ensure that noise is coupled common to both lines and rejected by the receivers.

- **Operation in environment with greater than 10mV differential noise**

TI recommends external failsafe biasing on its LVDS receivers for a number of system level and signal quality reasons. First, only an application that requires failsafe biasing needs to employ it. Second, the amount of failsafe biasing is now an application design parameter and can be custom tailored for the specific application. In applications in low noise environments, they may choose to use a very small bias if any. For applications with less balanced interconnects and/or in high noise environments they may choose to boost failsafe further. TI's "LVDS Owner's Manual provides detailed calculations for selecting the proper failsafe biasing resistors. Third, the common-mode voltage is biased by the resistors during the un-driven state. This is selected to be close to the nominal driver offset voltage (VOS). Thus when switching between driven and un-driven states, the common-mode modulation on the bus is held to a minimum.

For additional Failsafe Biasing information, please refer to Application Note AN-1194 ([SNLA051](#)) for more detail.

Pin Descriptions

Pin No. (SOIC)	Name	Description
2, 6, 10, 14	R _{I+}	Non-inverting receiver input pin
1, 7, 9, 15	R _{I-}	Inverting receiver input pin
3, 5, 11, 13	R _O	Receiver output pin
4	EN	Active high enable pin, OR-ed with EN*
12	EN*	Active low enable pin, OR-ed with EN
16	V _{CC}	Power supply pin, +5V ± 10%
8	Gnd	Ground pin

Radiation Environments

Careful consideration should be given to environmental conditions when using a product in a radiation environment.

Total Ionizing Dose

Radiation hardness assured (RHA) products are those part numbers with a total ionizing dose (TID) level specified in the Ordering Information table on the front page. Testing and qualification of these products is done on a wafer level according to MIL-STD-883G, Test Method 1019.7, Condition A and the "Extended room temperature anneal test" described in section 3.11 for application environment dose rates less than 0.19 rad(Si)/s. Wafer level TID data is available with lot shipments.

Single Event Latch-Up and Functional Interrupt

One time single event latch-up (SEL) and single event functional interrupt (SEFI) testing was performed according to EIA/JEDEC Standard, EIA/JEDEC57. The linear energy transfer threshold (LET_{th}) shown in the Features on the front page is the maximum LET tested. A test report is available upon request.

Single Event Upset

A report on single event upset (SEU) is available upon request.

Table 2. Revision History

Released	Revision	Section	Changes
3/01/06	A	New Release, Corporate format	1 MDS data sheet converted into Corp. data sheet format. MNDS90C032-X-RH Rev 1B1 will be archived.
10/10/06	B	Applications Information - Pg. 10, Physical Dimensions - Pg. 12	Deleted Shorted Inputs paragraph - page 10. Updated Physical Dimensions package drawings E20A, W16A to current revision - page 12. Revision A will be Archived.
9/28/2010	C	Receiver Table - Pg. 2, Application Information - Pg. 9 & 10 Order Information Table, General Description, Applications Information section	Deleted Full Fail-safe OPEN/SHORT or terminated - Page 2. & Paragraph RECEIVER FAIL-SAFE and 1, 2, 3 - Page 9 & 10. Revision B will be Archived. Copied general description and Receiver Failsafe from commercial d/s DS90C032B, dated Sept. 2003. Removed Code K devices. Added Radiation Environments paragraph to data sheet. Revision C will be Archived.
4/12/2013	D	New revision	Changed layout of National Data Sheet to TI format

PACKAGING INFORMATION

Orderable Device	Status (1)	Package Type	Package Drawing	Pins	Package Qty	Eco Plan (2)	Lead finish/ Ball material (6)	MSL Peak Temp (3)	Op Temp (°C)	Device Marking (4/5)	Samples
5962-9583401Q2A	ACTIVE	LCCC	NAJ	20	50	RoHS & Green	Call TI	Call TI	-55 to 125	DS90C032E -QML Q 5962-95834 01Q2A ACO 01Q2A >T	Samples
5962-9583401VFA	ACTIVE	CFP	NAD	16	19	Non-RoHS & Green	Call TI	Call TI	-55 to 125	DS90C032W- QMLV Q 5962-95834 01VFA ACO 01VFA >T	Samples
5962L9583401VFA	ACTIVE	CFP	NAD	16	19	Non-RoHS & Green	Call TI	Call TI	-55 to 125	DS90C032WL QMLV Q 5962L95834 01VFA ACO 01VFA >T	Samples
5962L9583401VZA	ACTIVE	CFP	NAC	16	42	Non-RoHS & Green	Call TI	Call TI	-55 to 125	DS90C032WGL QMLV Q 5962L95834 01VZA ACO 01VZA >T	Samples
DS90C032 MDR	ACTIVE	DIESALE	Y	0	30	RoHS & Green	Call TI	Level-1-NA-UNLIM	-55 to 125		Samples
DS90C032E-QML	ACTIVE	LCCC	NAJ	20	50	RoHS & Green	Call TI	Call TI	-55 to 125	DS90C032E -QML Q 5962-95834 01Q2A ACO 01Q2A >T	Samples
DS90C032W-QMLV	ACTIVE	CFP	NAD	16	19	Non-RoHS & Green	Call TI	Call TI	-55 to 125	DS90C032W- QMLV Q 5962-95834 01VFA ACO 01VFA >T	Samples
DS90C032WGLQMLV	ACTIVE	CFP	NAC	16	42	Non-RoHS & Green	Call TI	Call TI	-55 to 125	DS90C032WGL QMLV Q 5962L95834 01VZA ACO 01VZA >T	Samples

Orderable Device	Status (1)	Package Type	Package Drawing	Pins	Package Qty	Eco Plan (2)	Lead finish/ Ball material (6)	MSL Peak Temp (3)	Op Temp (°C)	Device Marking (4/5)	Samples
DS90C032WLQMLV	ACTIVE	CFP	NAD	16	19	Non-RoHS & Green	Call TI	Call TI	-55 to 125	DS90C032WL QMLV Q 5962L95834 01VFA ACO 01VFA >T	Samples

(1) The marketing status values are defined as follows:

ACTIVE: Product device recommended for new designs.

LIFEBUY: TI has announced that the device will be discontinued, and a lifetime-buy period is in effect.

NRND: Not recommended for new designs. Device is in production to support existing customers, but TI does not recommend using this part in a new design.

PREVIEW: Device has been announced but is not in production. Samples may or may not be available.

OBSELETE: TI has discontinued the production of the device.

(2) **RoHS:** TI defines "RoHS" to mean semiconductor products that are compliant with the current EU RoHS requirements for all 10 RoHS substances, including the requirement that RoHS substance do not exceed 0.1% by weight in homogeneous materials. Where designed to be soldered at high temperatures, "RoHS" products are suitable for use in specified lead-free processes. TI may reference these types of products as "Pb-Free".

RoHS Exempt: TI defines "RoHS Exempt" to mean products that contain lead but are compliant with EU RoHS pursuant to a specific EU RoHS exemption.

Green: TI defines "Green" to mean the content of Chlorine (Cl) and Bromine (Br) based flame retardants meet JS709B low halogen requirements of <=1000ppm threshold. Antimony trioxide based flame retardants must also meet the <=1000ppm threshold requirement.

(3) MSL, Peak Temp. - The Moisture Sensitivity Level rating according to the JEDEC industry standard classifications, and peak solder temperature.

(4) There may be additional marking, which relates to the logo, the lot trace code information, or the environmental category on the device.

(5) Multiple Device Markings will be inside parentheses. Only one Device Marking contained in parentheses and separated by a "~" will appear on a device. If a line is indented then it is a continuation of the previous line and the two combined represent the entire Device Marking for that device.

(6) Lead finish/Ball material - Orderable Devices may have multiple material finish options. Finish options are separated by a vertical ruled line. Lead finish/Ball material values may wrap to two lines if the finish value exceeds the maximum column width.

Important Information and Disclaimer:The information provided on this page represents TI's knowledge and belief as of the date that it is provided. TI bases its knowledge and belief on information provided by third parties, and makes no representation or warranty as to the accuracy of such information. Efforts are underway to better integrate information from third parties. TI has taken and continues to take reasonable steps to provide representative and accurate information but may not have conducted destructive testing or chemical analysis on incoming materials and chemicals. TI and TI suppliers consider certain information to be proprietary, and thus CAS numbers and other limited information may not be available for release.

In no event shall TI's liability arising out of such information exceed the total purchase price of the TI part(s) at issue in this document sold by TI to Customer on an annual basis.

OTHER QUALIFIED VERSIONS OF DS90C032QML, DS90C032QML-SP :

- Military : [DS90C032QML](#)
- Space : [DS90C032QML-SP](#)

NOTE: Qualified Version Definitions:

- Military - QML certified for Military and Defense Applications
- Space - Radiation tolerant, ceramic packaging and qualified for use in Space-based application

NAJ0020A

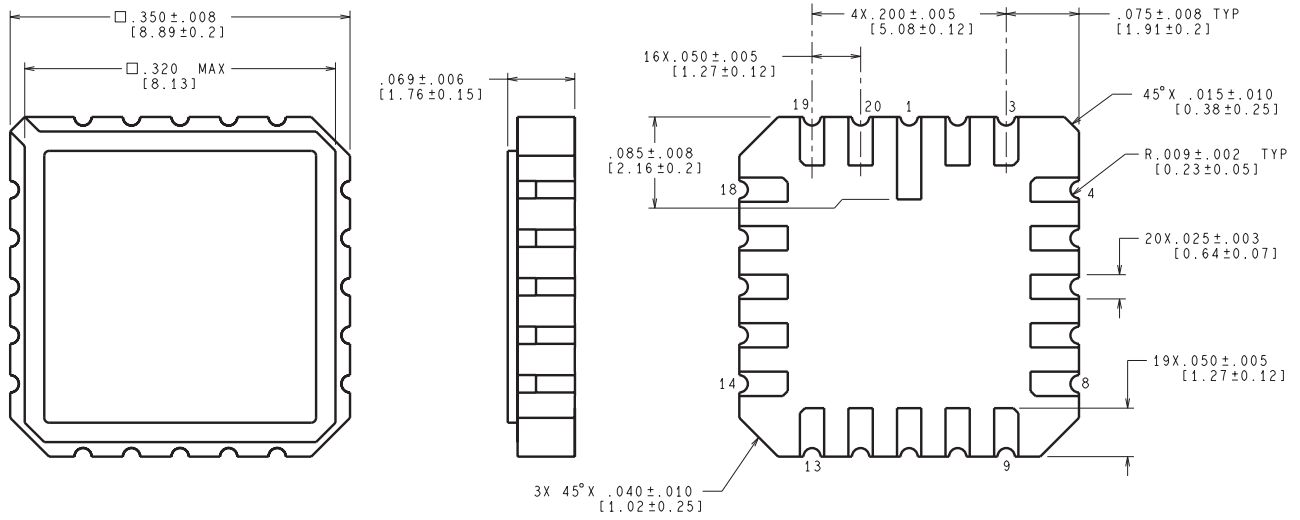

CONTROLLING DIMENSION IS INCH
VALUES IN [] ARE MILLIMETERS

E20A (Rev F)

NAD0016A

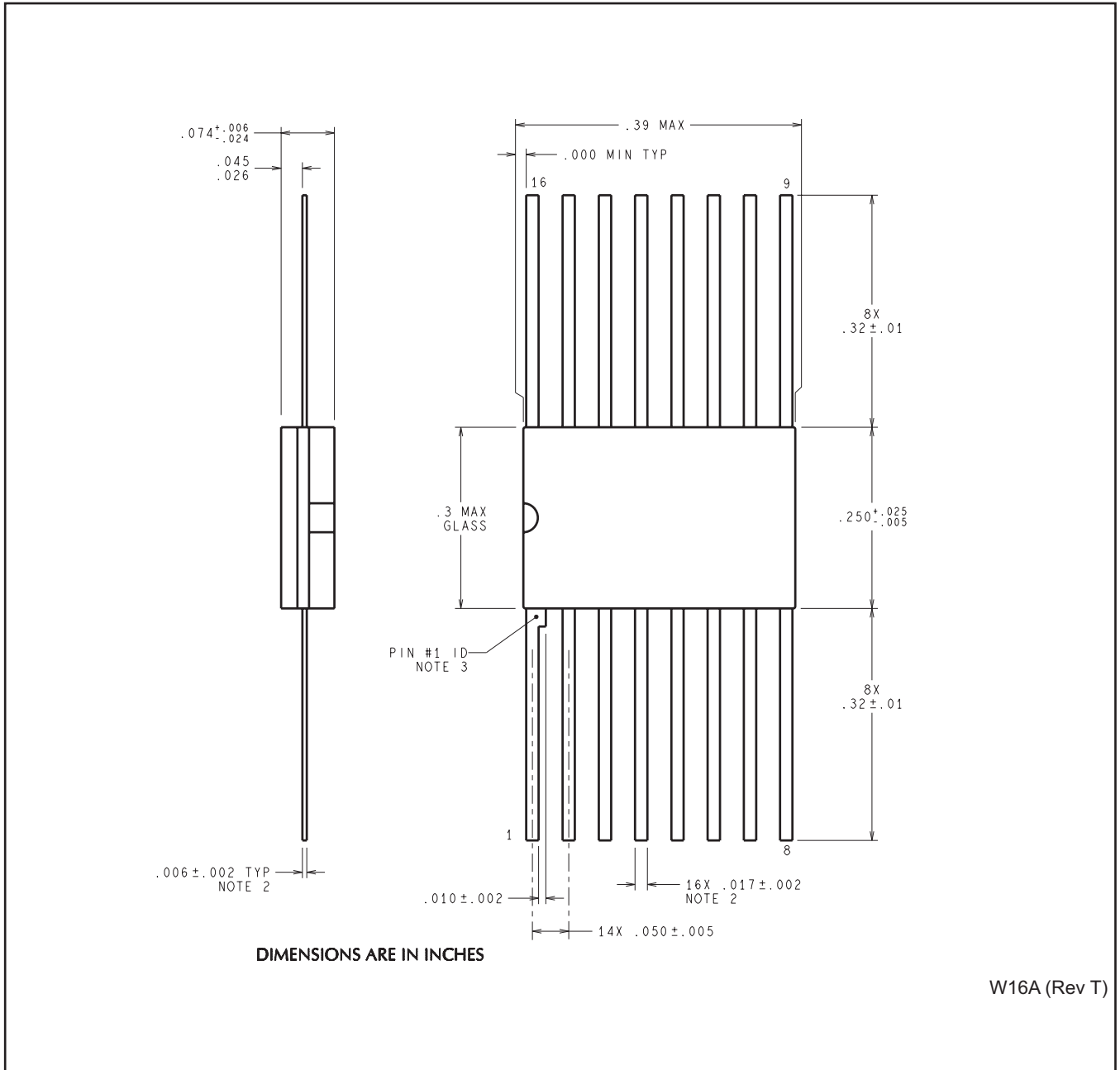

W16A (Rev T)

NAC0016A

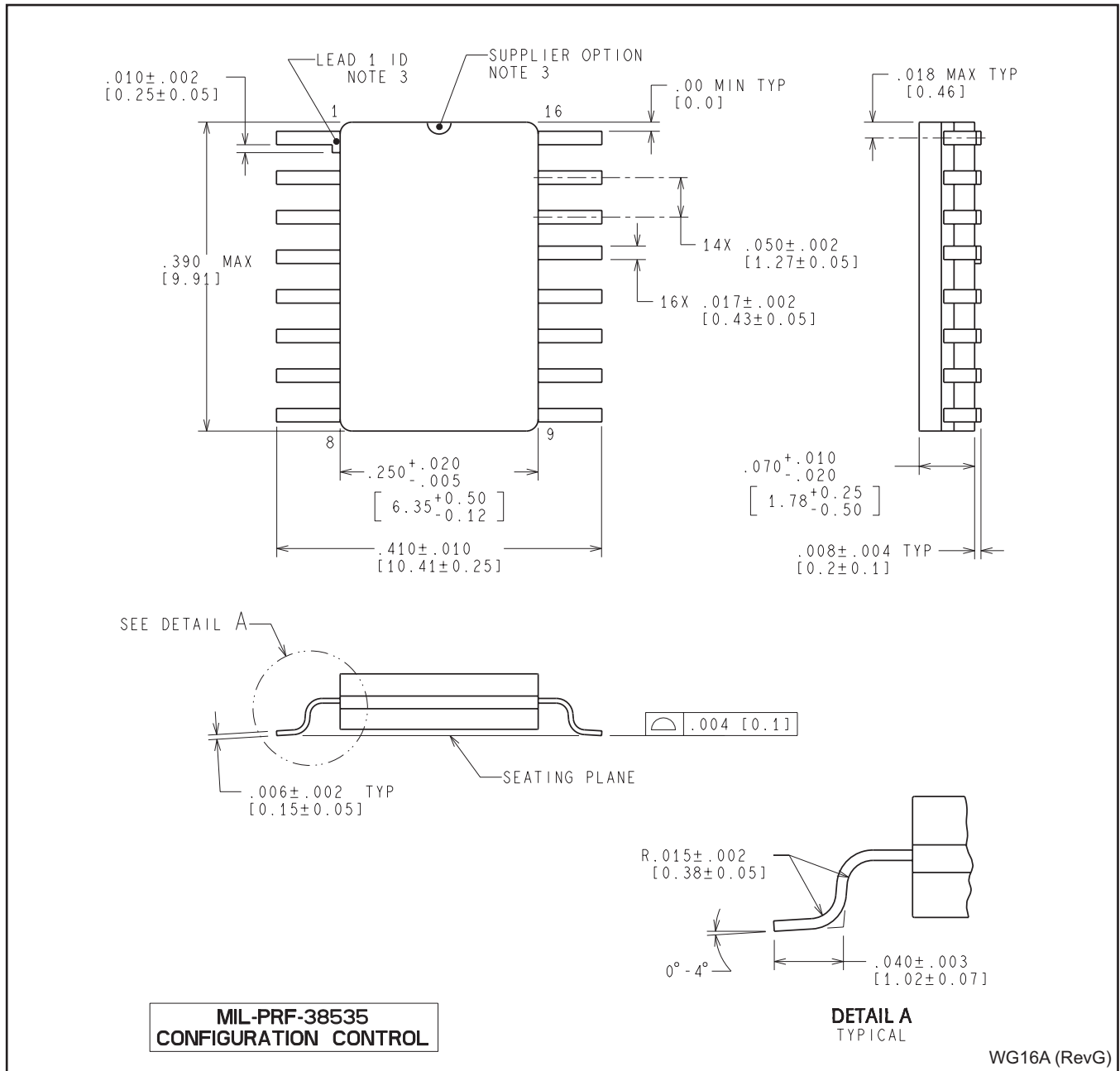

IMPORTANT NOTICE AND DISCLAIMER

TI PROVIDES TECHNICAL AND RELIABILITY DATA (INCLUDING DATASHEETS), DESIGN RESOURCES (INCLUDING REFERENCE DESIGNS), APPLICATION OR OTHER DESIGN ADVICE, WEB TOOLS, SAFETY INFORMATION, AND OTHER RESOURCES "AS IS" AND WITH ALL FAULTS, AND DISCLAIMS ALL WARRANTIES, EXPRESS AND IMPLIED, INCLUDING WITHOUT LIMITATION ANY IMPLIED WARRANTIES OF MERCHANTABILITY, FITNESS FOR A PARTICULAR PURPOSE OR NON-INFRINGEMENT OF THIRD PARTY INTELLECTUAL PROPERTY RIGHTS.

These resources are intended for skilled developers designing with TI products. You are solely responsible for (1) selecting the appropriate TI products for your application, (2) designing, validating and testing your application, and (3) ensuring your application meets applicable standards, and any other safety, security, or other requirements. These resources are subject to change without notice. TI grants you permission to use these resources only for development of an application that uses the TI products described in the resource. Other reproduction and display of these resources is prohibited. No license is granted to any other TI intellectual property right or to any third party intellectual property right. TI disclaims responsibility for, and you will fully indemnify TI and its representatives against, any claims, damages, costs, losses, and liabilities arising out of your use of these resources.

TI's products are provided subject to TI's Terms of Sale (<https://www.ti.com/legal/termsofsale.html>) or other applicable terms available either on [ti.com](https://www.ti.com) or provided in conjunction with such TI products. TI's provision of these resources does not expand or otherwise alter TI's applicable warranties or warranty disclaimers for TI products.

Mailing Address: Texas Instruments, Post Office Box 655303, Dallas, Texas 75265
Copyright © 2021, Texas Instruments Incorporated