

Chip Coils for High Frequency Horizontal Wire Wound

LQW15A_00 Series (0402 Size)

Dimension

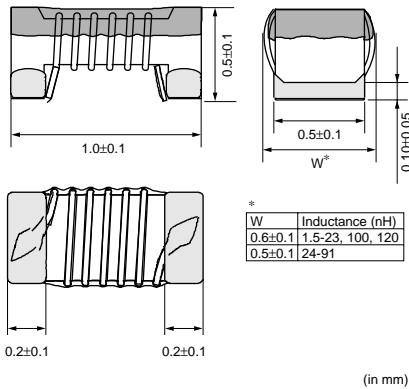

Packaging

Code	Packaging	Minimum Quantity
D	180mm Paper Tape	10000
J	330mm Paper Tape	50000
B	Bulk(Bag)	500

Rated Value (□: packaging code)

Part Number	Inductance	Test Frequency	Rated Current	Max. of DC resistance	Q (min.)	Test Frequency	Self Resonance Frequency (min.)
LQW15AN1N5B00□	1.5nH±0.1nH	100MHz	1000mA	0.03ohm	10	250MHz	18.0GHz
LQW15AN1N5C00□	1.5nH±0.2nH	100MHz	1000mA	0.03ohm	10	250MHz	18.0GHz
LQW15AN1N5D00□	1.5nH±0.5nH	100MHz	1000mA	0.03ohm	10	250MHz	18.0GHz
LQW15AN2N4B00□	2.4nH±0.1nH	100MHz	850mA	0.05ohm	20	250MHz	15.0GHz
LQW15AN2N4C00□	2.4nH±0.2nH	100MHz	850mA	0.05ohm	20	250MHz	15.0GHz
LQW15AN2N4D00□	2.4nH±0.5nH	100MHz	850mA	0.05ohm	20	250MHz	15.0GHz
LQW15AN2N5B00□	2.5nH±0.1nH	100MHz	850mA	0.05ohm	20	250MHz	15.0GHz
LQW15AN2N5C00□	2.5nH±0.2nH	100MHz	850mA	0.05ohm	20	250MHz	15.0GHz
LQW15AN2N5D00□	2.5nH±0.5nH	100MHz	850mA	0.05ohm	20	250MHz	15.0GHz
LQW15AN2N7B00□	2.7nH±0.1nH	100MHz	850mA	0.05ohm	20	250MHz	15.0GHz
LQW15AN2N7C00□	2.7nH±0.2nH	100MHz	850mA	0.05ohm	20	250MHz	15.0GHz
LQW15AN2N7D00□	2.7nH±0.5nH	100MHz	850mA	0.05ohm	20	250MHz	15.0GHz
LQW15AN2N9B00□	2.9nH±0.1nH	100MHz	750mA	0.07ohm	20	250MHz	15.0GHz
LQW15AN2N9C00□	2.9nH±0.2nH	100MHz	750mA	0.07ohm	20	250MHz	15.0GHz
LQW15AN2N9D00□	2.9nH±0.5nH	100MHz	750mA	0.07ohm	20	250MHz	15.0GHz
LQW15AN3N9B00□	3.9nH±0.1nH	100MHz	750mA	0.07ohm	25	250MHz	10.0GHz
LQW15AN3N9C00□	3.9nH±0.2nH	100MHz	750mA	0.07ohm	25	250MHz	10.0GHz
LQW15AN3N9D00□	3.9nH±0.5nH	100MHz	750mA	0.07ohm	25	250MHz	10.0GHz
LQW15AN4N1B00□	4.1nH±0.1nH	100MHz	750mA	0.07ohm	25	250MHz	10.0GHz
LQW15AN4N1C00□	4.1nH±0.2nH	100MHz	750mA	0.07ohm	25	250MHz	10.0GHz
LQW15AN4N1D00□	4.1nH±0.5nH	100MHz	750mA	0.07ohm	25	250MHz	10.0GHz
LQW15AN4N3B00□	4.3nH±0.1nH	100MHz	750mA	0.07ohm	25	250MHz	10.0GHz
LQW15AN4N3C00□	4.3nH±0.2nH	100MHz	750mA	0.07ohm	25	250MHz	10.0GHz

Operating Temperature Range: -55°C to +125°C
Only for reflow soldering.

Continued on the following page.

● This data sheet is applied for CHIP COIL used for General Electronics equipment for your design.

Note:

1. This datasheet is downloaded from the website of Murata Manufacturing co., Ltd. Therefore, it's specifications are subject to change or our products in it may be discontinued without advance notice. Please check with our sales representatives or product engineers before ordering.
2. This datasheet has only typical specifications because there is no space for detailed specifications. Therefore, please approve our product specifications or transact the approval sheet for product specifications before ordering.

 Continued from the preceding page.

Part Number	Inductance	Test Frequency	Rated Current	Max. of DC resistance	Q (min.)	Test Frequency	Self Resonance Frequency (min.)
LQW15AN4N3D00□	4.3nH±0.5nH	100MHz	750mA	0.07ohm	25	250MHz	10.0GHz
LQW15AN4N7B00□	4.7nH±0.1nH	100MHz	750mA	0.07ohm	25	250MHz	8.0GHz
LQW15AN4N7C00□	4.7nH±0.2nH	100MHz	750mA	0.07ohm	25	250MHz	8.0GHz
LQW15AN4N7D00□	4.7nH±0.5nH	100MHz	750mA	0.07ohm	25	250MHz	8.0GHz
LQW15AN5N1B00□	5.1nH±0.1nH	100MHz	600mA	0.12ohm	25	250MHz	8.0GHz
LQW15AN5N1C00□	5.1nH±0.2nH	100MHz	600mA	0.12ohm	25	250MHz	8.0GHz
LQW15AN5N1D00□	5.1nH±0.5nH	100MHz	600mA	0.12ohm	25	250MHz	8.0GHz
LQW15AN5N8B00□	5.8nH±0.1nH	100MHz	700mA	0.12ohm	25	250MHz	8.0GHz
LQW15AN5N8C00□	5.8nH±0.2nH	100MHz	700mA	0.12ohm	25	250MHz	8.0GHz
LQW15AN5N8D00□	5.8nH±0.5nH	100MHz	700mA	0.12ohm	25	250MHz	8.0GHz
LQW15AN6N2B00□	6.2nH±0.1nH	100MHz	700mA	0.09ohm	25	250MHz	8.0GHz
LQW15AN6N2C00□	6.2nH±0.2nH	100MHz	700mA	0.09ohm	25	250MHz	8.0GHz
LQW15AN6N2D00□	6.2nH±0.5nH	100MHz	700mA	0.09ohm	25	250MHz	8.0GHz
LQW15AN6N8G00□	6.8nH±2%	100MHz	700mA	0.09ohm	25	250MHz	6.0GHz
LQW15AN6N8H00□	6.8nH±3%	100MHz	700mA	0.09ohm	25	250MHz	6.0GHz
LQW15AN6N8J00□	6.8nH±5%	100MHz	700mA	0.09ohm	25	250MHz	6.0GHz
LQW15AN7N3G00□	7.3nH±2%	100MHz	570mA	0.13ohm	25	250MHz	6.0GHz
LQW15AN7N3H00□	7.3nH±3%	100MHz	570mA	0.13ohm	25	250MHz	6.0GHz
LQW15AN7N3J00□	7.3nH±5%	100MHz	570mA	0.13ohm	25	250MHz	6.0GHz
LQW15AN7N5G00□	7.5nH±2%	100MHz	570mA	0.13ohm	25	250MHz	6.0GHz
LQW15AN7N5H00□	7.5nH±3%	100MHz	570mA	0.13ohm	25	250MHz	6.0GHz
LQW15AN7N5J00□	7.5nH±5%	100MHz	570mA	0.13ohm	25	250MHz	6.0GHz
LQW15AN8N2G00□	8.2nH±2%	100MHz	540mA	0.14ohm	25	250MHz	5.5GHz
LQW15AN8N2H00□	8.2nH±3%	100MHz	540mA	0.14ohm	25	250MHz	5.5GHz
LQW15AN8N2J00□	8.2nH±5%	100MHz	540mA	0.14ohm	25	250MHz	5.5GHz
LQW15AN8N7G00□	8.7nH±2%	100MHz	540mA	0.14ohm	25	250MHz	5.5GHz
LQW15AN8N7H00□	8.7nH±3%	100MHz	540mA	0.14ohm	25	250MHz	5.5GHz
LQW15AN8N7J00□	8.7nH±5%	100MHz	540mA	0.14ohm	25	250MHz	5.5GHz
LQW15AN9N1G00□	9.1nH±2%	100MHz	540mA	0.14ohm	25	250MHz	5.5GHz
LQW15AN9N1H00□	9.1nH±3%	100MHz	540mA	0.14ohm	25	250MHz	5.5GHz
LQW15AN9N1J00□	9.1nH±5%	100MHz	540mA	0.14ohm	25	250MHz	5.5GHz
LQW15AN9N5G00□	9.5nH±2%	100MHz	540mA	0.14ohm	25	250MHz	5.5GHz
LQW15AN9N5H00□	9.5nH±3%	100MHz	540mA	0.14ohm	25	250MHz	5.5GHz
LQW15AN9N5J00□	9.5nH±5%	100MHz	540mA	0.14ohm	25	250MHz	5.5GHz
LQW15AN10NG00□	10nH±2%	100MHz	500mA	0.17ohm	25	250MHz	5.5GHz
LQW15AN10NH00□	10nH±3%	100MHz	500mA	0.17ohm	25	250MHz	5.5GHz
LQW15AN10NJ00□	10nH±5%	100MHz	500mA	0.17ohm	25	250MHz	5.5GHz
LQW15AN11NG00□	11nH±2%	100MHz	500mA	0.14ohm	30	250MHz	5.5GHz
LQW15AN11NH00□	11nH±3%	100MHz	500mA	0.14ohm	30	250MHz	5.5GHz
LQW15AN11NJ00□	11nH±5%	100MHz	500mA	0.14ohm	30	250MHz	5.5GHz
LQW15AN12NG00□	12nH±2%	100MHz	500mA	0.14ohm	30	250MHz	5.5GHz

Operating Temperature Range: -55°C to +125°C

Only for reflow soldering.

Continued on the following page. 

● This data sheet is applied for CHIP COIL used for General Electronics equipment for your design.

 **Note:**

1. This datasheet is downloaded from the website of Murata Manufacturing co., ltd. Therefore, it's specifications are subject to change or our products in it may be discontinued without advance notice. Please check with our sales representatives or product engineers before ordering.
2. This datasheet has only typical specifications because there is no space for detailed specifications. Therefore, please approve our product specifications or transact the approval sheet for product specifications before ordering.

 Continued from the preceding page.

Part Number	Inductance	Test Frequency	Rated Current	Max. of DC resistance	Q (min.)	Test Frequency	Self Resonance Frequency (min.)
LQW15AN12NH00□	12nH±3%	100MHz	500mA	0.14ohm	30	250MHz	5.5GHz
LQW15AN12NJ00□	12nH±5%	100MHz	500mA	0.14ohm	30	250MHz	5.5GHz
LQW15AN13NG00□	13nH±2%	100MHz	430mA	0.21ohm	25	250MHz	5.0GHz
LQW15AN13NH00□	13nH±3%	100MHz	430mA	0.21ohm	25	250MHz	5.0GHz
LQW15AN13NJ00□	13nH±5%	100MHz	430mA	0.21ohm	25	250MHz	5.0GHz
LQW15AN15NG00□	15nH±2%	100MHz	460mA	0.16ohm	30	250MHz	5.0GHz
LQW15AN15NH00□	15nH±3%	100MHz	460mA	0.16ohm	30	250MHz	5.0GHz
LQW15AN15NJ00□	15nH±5%	100MHz	460mA	0.16ohm	30	250MHz	5.0GHz
LQW15AN16NG00□	16nH±2%	100MHz	370mA	0.24ohm	25	250MHz	4.5GHz
LQW15AN16NH00□	16nH±3%	100MHz	370mA	0.24ohm	25	250MHz	4.5GHz
LQW15AN16NJ00□	16nH±5%	100MHz	370mA	0.24ohm	25	250MHz	4.5GHz
LQW15AN18NG00□	18nH±2%	100MHz	370mA	0.27ohm	25	250MHz	4.5GHz
LQW15AN18NH00□	18nH±3%	100MHz	370mA	0.27ohm	25	250MHz	4.5GHz
LQW15AN18NJ00□	18nH±5%	100MHz	370mA	0.27ohm	25	250MHz	4.5GHz
LQW15AN19NG00□	19nH±2%	100MHz	370mA	0.27ohm	25	250MHz	4.5GHz
LQW15AN19NH00□	19nH±3%	100MHz	370mA	0.27ohm	25	250MHz	4.5GHz
LQW15AN19NJ00□	19nH±5%	100MHz	370mA	0.27ohm	25	250MHz	4.5GHz
LQW15AN20NG00□	20nH±2%	100MHz	370mA	0.27ohm	25	250MHz	4.0GHz
LQW15AN20NH00□	20nH±3%	100MHz	370mA	0.27ohm	25	250MHz	4.0GHz
LQW15AN20NJ00□	20nH±5%	100MHz	370mA	0.27ohm	25	250MHz	4.0GHz
LQW15AN22NG00□	22nH±2%	100MHz	310mA	0.30ohm	25	250MHz	4.0GHz
LQW15AN22NH00□	22nH±3%	100MHz	310mA	0.30ohm	25	250MHz	4.0GHz
LQW15AN22NJ00□	22nH±5%	100MHz	310mA	0.30ohm	25	250MHz	4.0GHz
LQW15AN23NG00□	23nH±2%	100MHz	310mA	0.30ohm	25	250MHz	3.8GHz
LQW15AN23NH00□	23nH±3%	100MHz	310mA	0.30ohm	25	250MHz	3.8GHz
LQW15AN23NJ00□	23nH±5%	100MHz	310mA	0.30ohm	25	250MHz	3.8GHz
LQW15AN24NG00□	24nH±2%	100MHz	280mA	0.52ohm	25	250MHz	3.5GHz
LQW15AN24NH00□	24nH±3%	100MHz	280mA	0.52ohm	25	250MHz	3.5GHz
LQW15AN24NJ00□	24nH±5%	100MHz	280mA	0.52ohm	25	250MHz	3.5GHz
LQW15AN27NG00□	27nH±2%	100MHz	280mA	0.52ohm	25	250MHz	3.5GHz
LQW15AN27NH00□	27nH±3%	100MHz	280mA	0.52ohm	25	250MHz	3.5GHz
LQW15AN27NJ00□	27nH±5%	100MHz	280mA	0.52ohm	25	250MHz	3.5GHz
LQW15AN30NG00□	30nH±2%	100MHz	270mA	0.58ohm	25	250MHz	3.3GHz
LQW15AN30NH00□	30nH±3%	100MHz	270mA	0.58ohm	25	250MHz	3.3GHz
LQW15AN30NJ00□	30nH±5%	100MHz	270mA	0.58ohm	25	250MHz	3.3GHz
LQW15AN33NG00□	33nH±2%	100MHz	260mA	0.63ohm	25	250MHz	3.2GHz
LQW15AN33NH00□	33nH±3%	100MHz	260mA	0.63ohm	25	250MHz	3.2GHz
LQW15AN33NJ00□	33nH±5%	100MHz	260mA	0.63ohm	25	250MHz	3.2GHz
LQW15AN36NG00□	36nH±2%	100MHz	260mA	0.63ohm	25	250MHz	3.1GHz
LQW15AN36NH00□	36nH±3%	100MHz	260mA	0.63ohm	25	250MHz	3.1GHz
LQW15AN36NJ00□	36nH±5%	100MHz	260mA	0.63ohm	25	250MHz	3.1GHz

Operating Temperature Range: -55°C to +125°C
Only for reflow soldering.

Continued on the following page. 

● This data sheet is applied for CHIP COIL used for General Electronics equipment for your design.

 **Note:**

1. This datasheet is downloaded from the website of Murata Manufacturing co., Ltd. Therefore, it's specifications are subject to change or our products in it may be discontinued without advance notice. Please check with our sales representatives or product engineers before ordering.
2. This datasheet has only typical specifications because there is no space for detailed specifications. Therefore, please approve our product specifications or transact the approval sheet for product specifications before ordering.

 Continued from the preceding page.

Part Number	Inductance	Test Frequency	Rated Current	Max. of DC resistance	Q (min.)	Test Frequency	Self Resonance Frequency (min.)
LQW15AN39NG00□	39nH±2%	100MHz	250mA	0.70ohm	25	250MHz	3.0GHz
LQW15AN39NH00□	39nH±3%	100MHz	250mA	0.70ohm	25	250MHz	3.0GHz
LQW15AN39NJ00□	39nH±5%	100MHz	250mA	0.70ohm	25	250MHz	3.0GHz
LQW15AN40NG00□	40nH±2%	100MHz	250mA	0.70ohm	25	250MHz	3.0GHz
LQW15AN40NH00□	40nH±3%	100MHz	250mA	0.70ohm	25	250MHz	3.0GHz
LQW15AN40NJ00□	40nH±5%	100MHz	250mA	0.70ohm	25	250MHz	3.0GHz
LQW15AN43NG00□	43nH±2%	100MHz	250mA	0.70ohm	25	250MHz	3.0GHz
LQW15AN43NH00□	43nH±3%	100MHz	250mA	0.70ohm	25	250MHz	3.0GHz
LQW15AN43NJ00□	43nH±5%	100MHz	250mA	0.70ohm	25	250MHz	3.0GHz
LQW15AN47NG00□	47nH±2%	100MHz	210mA	1.08ohm	25	200MHz	2.9GHz
LQW15AN47NH00□	47nH±3%	100MHz	210mA	1.08ohm	25	200MHz	2.9GHz
LQW15AN47NJ00□	47nH±5%	100MHz	210mA	1.08ohm	25	200MHz	2.9GHz
LQW15AN51NG00□	51nH±2%	100MHz	210mA	1.08ohm	25	200MHz	2.85GHz
LQW15AN51NH00□	51nH±3%	100MHz	210mA	1.08ohm	25	200MHz	2.85GHz
LQW15AN51NJ00□	51nH±5%	100MHz	210mA	1.08ohm	25	200MHz	2.85GHz
LQW15AN56NG00□	56nH±2%	100MHz	200mA	1.17ohm	25	200MHz	2.8GHz
LQW15AN56NH00□	56nH±3%	100MHz	200mA	1.17ohm	25	200MHz	2.8GHz
LQW15AN56NJ00□	56nH±5%	100MHz	200mA	1.17ohm	25	200MHz	2.8GHz
LQW15AN62NG00□	62nH±2%	100MHz	145mA	1.82ohm	20	200MHz	2.6GHz
LQW15AN62NH00□	62nH±3%	100MHz	145mA	1.82ohm	20	200MHz	2.6GHz
LQW15AN62NJ00□	62nH±5%	100MHz	145mA	1.82ohm	20	200MHz	2.6GHz
LQW15AN68NG00□	68nH±2%	100MHz	140mA	1.96ohm	20	200MHz	2.5GHz
LQW15AN68NJ00□	68nH±5%	100MHz	140mA	1.96ohm	20	200MHz	2.5GHz
LQW15AN72NG00□	72nH±2%	100MHz	135mA	2.10ohm	20	150MHz	2.5GHz
LQW15AN72NJ00□	72nH±5%	100MHz	135mA	2.10ohm	20	150MHz	2.5GHz
LQW15AN75NG00□	75nH±2%	100MHz	135mA	2.10ohm	20	150MHz	2.4GHz
LQW15AN75NJ00□	75nH±5%	100MHz	135mA	2.10ohm	20	150MHz	2.4GHz
LQW15AN82NG00□	82nH±2%	100MHz	130mA	2.24ohm	20	150MHz	2.3GHz
LQW15AN82NJ00□	82nH±5%	100MHz	130mA	2.24ohm	20	150MHz	2.3GHz
LQW15AN91NG00□	91nH±2%	100MHz	125mA	2.38ohm	20	150MHz	2.1GHz
LQW15AN91NJ00□	91nH±5%	100MHz	125mA	2.38ohm	20	150MHz	2.1GHz
LQW15ANR10J00□	100nH±5%	100MHz	120mA	2.52ohm	20	150MHz	1.5GHz
LQW15ANR12J00□	120nH±5%	100MHz	110mA	2.66ohm	20	150MHz	1.0GHz

Operating Temperature Range: -55°C to +125°C

Only for reflow soldering.

Continued on the following page. 

● This data sheet is applied for CHIP COIL used for General Electronics equipment for your design.

 **Note:**

1. This datasheet is downloaded from the website of Murata Manufacturing co., Ltd. Therefore, it's specifications are subject to change or our products in it may be discontinued without advance notice. Please check with our sales representatives or product engineers before ordering.
2. This datasheet has only typical specifications because there is no space for detailed specifications. Therefore, please approve our product specifications or transact the approval sheet for product specifications before ordering.

Continued from the preceding page.

■ Q-Frequency Characteristics (Typ.)

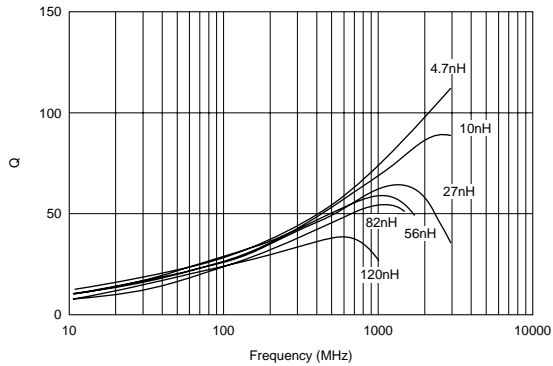

■ Inductance-Frequency Characteristics (Typ.)

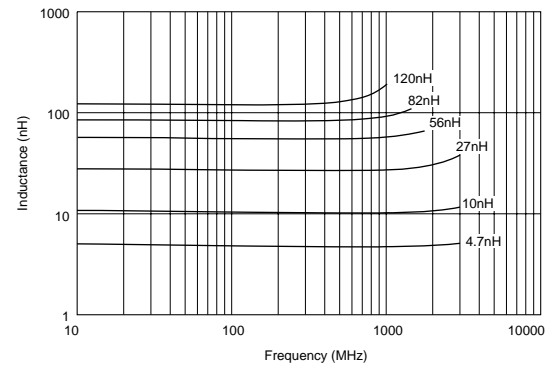

■ ⚠ Caution/Notice

⚠ Caution (Rating)

Do not use products beyond the rated current as this may create excessive heat.

Notice

Solderability of Tin plating termination chip might be deteriorated when low temperature soldering profile where peak solder temperature is below the Tin melting point is used. Please confirm the solderability of Tin plating termination chip before use.

● This data sheet is applied for CHIP COIL used for General Electronics equipment for your design.

⚠ Note:

1. This datasheet is downloaded from the website of Murata Manufacturing co., Ltd. Therefore, it's specifications are subject to change or our products in it may be discontinued without advance notice. Please check with our sales representatives or product engineers before ordering.
2. This datasheet has only typical specifications because there is no space for detailed specifications. Therefore, please approve our product specifications or transact the approval sheet for product specifications before ordering.