

OPA1662-Q1 Dual, 3.3 nV/ $\sqrt{\text{Hz}}$ Noise, 0.00006% THD+N, RRO, Bipolar-Input Audio Operational Amplifier

1 Features

- Qualified for Automotive Applications
- AEC-Q100 Qualified With the Following Results
 - Device Temperature Grade 3: -40°C to 85°C Ambient Operating Temperature Range
 - Device HBM ESD Classification Level H2
 - Device CDM ESD Classification Level C3B
- Low Noise: 3.3 nV/ $\sqrt{\text{Hz}}$ at 1 kHz
- Low Distortion: 0.00006% at 1 kHz
- Low Quiescent Current: 1.5 mA per Channel
- Slew Rate: 17 V/ μs
- Wide Gain Bandwidth: 22 MHz ($G = 1$)
- Unity Gain Stable
- Rail-to-Rail Output
- Wide Supply Range: $\pm 1.5\text{ V}$ to $\pm 18\text{ V}$, or 3 V to 36 V
- Small Package Sizes:
 - Dual: 8-Pin SOIC and VSSOP

2 Applications

- Automotive
- Car Audio
- Premium Audio
- External Audio Amplifiers
- Body Control Modules

3 Description

The OPA1662-Q1 is a dual, bipolar-input operational amplifier which is well suited for premium audio external amplifier applications in infotainment and cluster systems. In audio systems, the main concern is to ensure a clear, quality output signal which means minimizing any noise introduced to the signal. The OPA1662-Q1 offers low noise density with an ultra-low distortion of 0.00006% at 1 kHz that maximizes the signal output. Additionally, this op amp offers rail-to-rail output swing to within 600 mV with 2-k Ω load. The wide headroom ensures that the output signal does not clip, and therefore preserves the audio quality.

the OPA1662-Q1 operates over a very wide supply range of $\pm 1.5\text{ V}$ to $\pm 18\text{ V}$, or 3 V to 36 V, on only 1.5 mA of supply current per channel. The wide supply range enables design flexibility for the device as it can be integrated from a power amplifier driven by the battery to being driven from an ADC to DAC for low-power applications. Additionally, this device also has a high-output drive capability of $\pm 30\text{ mA}$ and can act as the sole audio amplifier for low-power applications, such as for cluster chimes.

Device Information⁽¹⁾

PART NUMBER	PACKAGE	BODY SIZE (NOM)
OPA1662-Q1	SOIC (8)	4.90 mm x 3.91 mm
	VSSOP (8)	3.00 mm x 3.00 mm

(1) For all available packages, see the orderable addendum at the end of the data sheet.

Input Voltage Noise Density and Input Current Noise Density vs Frequency

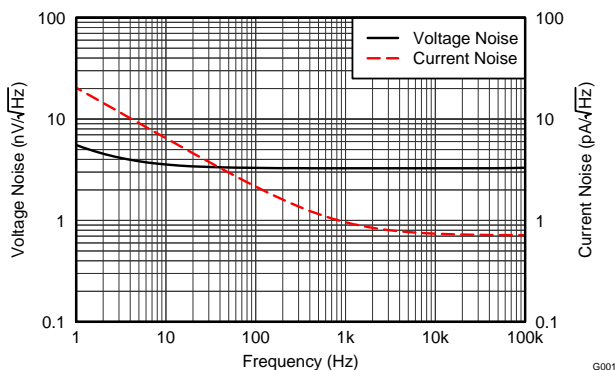

THD+N Ratio vs Frequency

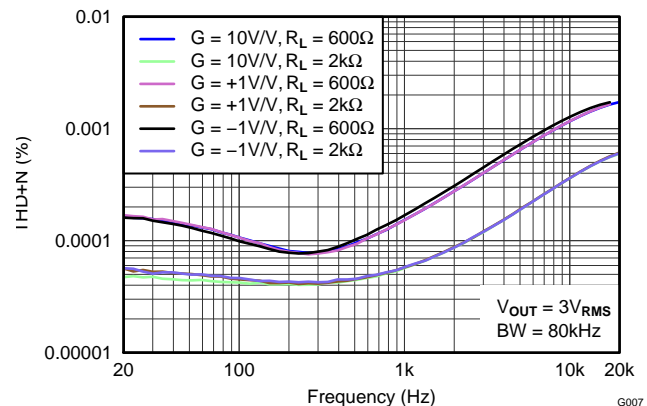

Table of Contents

1 Features 1 2 Applications 1 3 Description 1 4 Revision History 2 5 Description Continued 3 6 Pin Configuration and Functions 3 7 Specifications 3 7.1 Absolute Maximum Ratings 3 7.2 ESD Ratings..... 4 7.3 Recommended Operating Conditions 4 7.4 Thermal Information 4 7.5 Electrical Characteristics: $V_S = \pm 15\text{ V}$ 4 7.6 Electrical Characteristics: $V_S = 5\text{ V}$ 5 7.7 Typical Characteristics 7 8 Detailed Description 14 8.1 Overview 14 8.2 Functional Block Diagram 14 8.3 Feature Description..... 14	8.4 Device Functional Modes..... 19 9 Application and Implementation 20 9.1 Application Information..... 20 9.2 Typical Application 20 10 Power Supply Recommendations 22 11 Layout 22 11.1 Layout Guidelines 22 11.2 Layout Example 23 11.3 Power Dissipation 23 12 Device and Documentation Support 24 12.1 Documentation Support 24 12.2 Receiving Notification of Documentation Updates 24 12.3 Community Resources..... 24 12.4 Trademarks 24 12.5 Electrostatic Discharge Caution..... 24 12.6 Glossary 24 13 Mechanical, Packaging, and Orderable Information 24
--	--

4 Revision History

NOTE: Page numbers for previous revisions may differ from page numbers in the current version.

Changes from Revision B (October 2012) to Revision C	Page
• Added <i>ESD Ratings</i> table, <i>Feature Description</i> section, <i>Device Functional Modes</i> , <i>Application and Implementation</i> section, <i>Power Supply Recommendations</i> section, <i>Layout</i> section, <i>Device and Documentation Support</i> section, and <i>Mechanical, Packaging, and Orderable Information</i> section.	1
• Removed <i>Ordering Information</i> table, see POA at the end of the data sheet.....	1
• Changed the <i>Description</i> section.....	1

Changes from Revision A (September 2012) to Revision B	Page
• Changed top-side marking for OPA1662AIDRQ1 from preview to O1662Q in <i>Ordering Information</i> table.....	1
• Changed Grade 1 to Grade 3 in <i>Features</i>	1

Changes from Original (July 2012) to Revision A	Page
• Device going from 2-page preview to production status, full-length document included in this revision.	1

5 Description Continued

The device also features completely independent circuitry for each of the two channels to enable low crosstalk and freedom from interactions between each channel, even when overdriven or overloaded. This feature enables customers to drive two different audio signals with ease of mind that the signals are not affected by each other.

The OPA1662-Q1 offers a wide bandwidth of 22 MHz and high slew rate of 17 V/ μ s which is applicable as a high and low side sensing for ripple currents in SMPS devices or motor drives. As a current sensor, the OPA1662-Q1 can be used as peak current mode control, with the op amps offering stability and enabling higher bandwidth for the system. The OPA1662-Q1 is applicable in body control modules and HEV or EV converters where motors typically are used.

6 Pin Configuration and Functions

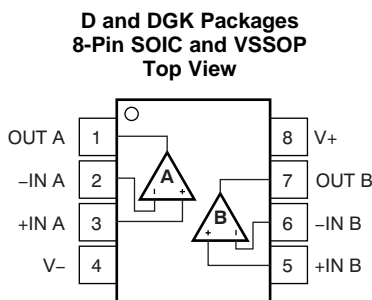

Pin Functions

PIN		I/O	DESCRIPTION
NAME	NO.		
+IN A	3	I	Noninverting input channel A
-IN A	2	I	Inverting input channel A
+IN B	5	I	Noninverting input channel B
-IN B	6	I	Inverting input channel B
OUT_A	1	O	Output, channel A
OUT_B	7	O	Output, channel B
V-	4	—	Negative (lowest) power supply
V+	8	—	Positive (highest) power supply

7 Specifications

7.1 Absolute Maximum Ratings

over operating free-air temperature range (unless otherwise noted)⁽¹⁾

	MIN	MAX	UNIT
Supply voltage, (V+) – (V-)		40	V
Input voltage	(V-) – 0.5	(V+) + 0.5	V
Input current (all pins except power-supply pins)		\pm 10	mA
Output short-circuit ⁽²⁾		Continuous	
Operating ambient temperature	-40	125	°C
Junction temperature, T _J		200	°C
Storage temperature, T _{stg}	-65	150	°C

(1) Stresses beyond those listed under *Absolute Maximum Ratings* may cause permanent damage to the device. These are stress ratings only, which do not imply functional operation of the device at these or any other conditions beyond those indicated under *Recommended Operating Conditions*. Exposure to absolute-maximum-rated conditions for extended periods may affect device reliability.

(2) Short-circuit to V_S / 2 (ground in symmetrical dual supply setups), one amplifier per package.

7.2 ESD Ratings

		VALUE	UNIT
$V_{(ESD)}$	Electrostatic discharge	Human-body model (HBM), per AEC Q100-002 ⁽¹⁾	± 2000
		Charged-device model (CDM), per AEC Q100-011	± 750

(1) AEC Q100-002 indicates that HBM stressing shall be in accordance with the ANSI/ESDA/JEDEC JS-001 specification.

7.3 Recommended Operating Conditions

over operating free-air temperature range (unless otherwise noted)

		MIN	MAX	UNIT
V_S	Supply voltage, (V+) – (V–)	3 (± 1.5)	36 (± 18)	V
T_A	Operating ambient temperature	–40	125	°C

7.4 Thermal Information

THERMAL METRIC ⁽¹⁾		OPA1662-Q1		UNIT
		D (SOIC)	DGK (VSSOP)	
		8 PINS	8 PINS	
$R_{\theta JA}$	Junction-to-ambient thermal resistance	156.3	225.4	°C/W
$R_{\theta JC(top)}$	Junction-to-case (top) thermal resistance	85.5	78.8	°C/W
$R_{\theta JB}$	Junction-to-board thermal resistance	64.9	110.5	°C/W
Ψ_{JT}	Junction-to-top characterization parameter	33.8	14.6	°C/W
Ψ_{JB}	Junction-to-board characterization parameter	64.3	108.5	°C/W

(1) For more information about traditional and new thermal metrics, see the [Semiconductor and IC Package Thermal Metrics](#) application report.

7.5 Electrical Characteristics: $V_S = \pm 15$ V

$T_A = 25^\circ\text{C}$, $V_{CM} = V_{OUT} = \text{midsupply}$, and $R_L = 2\text{ k}\Omega$ (unless otherwise noted)

PARAMETER		TEST CONDITIONS		MIN	TYP	MAX	UNIT
AUDIO PERFORMANCE							
THD+N	Total harmonic distortion + noise	$G = 1$, $f = 1\text{ kHz}$, $V_O = 3 V_{RMS}$		0.00006%			
					–124		dB
IMD	Intermodulation distortion	$G = 1$, $V_O = 3 V_{RMS}$		SMPTE two-tone, 4:1 (60 Hz and 7 kHz)		0.00004%	
					–128		dB
				DIM 30 (3-kHz square wave and 15-kHz sine wave)		0.00004%	
					–128		dB
		CCIF twin-tone (19 kHz and 20 kHz)		0.00004%			
			–128		dB		
FREQUENCY RESPONSE							
GBW	Gain-bandwidth product	$G = 1$			22		MHz
SR	Slew rate	$G = -1$			17		V/ μs
		Full power bandwidth ⁽¹⁾		$V_O = 1 V_P$		2.7	
	Overload recovery time	$G = -10$			1		μs
	Channel separation (dual and quad)	$f = 1\text{ kHz}$			–120		dB
NOISE							
e_n	Input voltage noise	$f = 20\text{ Hz to } 20\text{ kHz}$			2.8		μV_{PP}
	Input voltage noise density	$f = 1\text{ kHz}$			3.3		$\text{nV}/\sqrt{\text{Hz}}$
		$f = 100\text{ Hz}$			5		$\text{nV}/\sqrt{\text{Hz}}$
i_n	Input current noise density	$f = 1\text{ kHz}$			1		$\text{pA}/\sqrt{\text{Hz}}$
		$f = 100\text{ Hz}$			2		$\text{pA}/\sqrt{\text{Hz}}$

(1) Full-power bandwidth = $SR / (2\pi \times V_P)$, where SR = slew rate.

Electrical Characteristics: $V_S = \pm 15\text{ V}$ (continued)
 $T_A = 25^\circ\text{C}$, $V_{CM} = V_{OUT} = \text{midsupply}$, and $R_L = 2\text{ k}\Omega$ (unless otherwise noted)

PARAMETER		TEST CONDITIONS	MIN	TYP	MAX	UNIT
OFFSET VOLTAGE						
V_{OS}	Input offset voltage	$V_S = \pm 1.5\text{ V to } \pm 18\text{ V}$		± 0.5	± 1.5	mV
		$V_S = \pm 1.5\text{ V to } \pm 18\text{ V}$, $T_A = -40^\circ\text{C to } 85^\circ(2)$		2	8	$\mu\text{V}/^\circ\text{C}$
PSRR	Power-supply rejection ratio	$V_S = \pm 1.5\text{ V to } \pm 18\text{ V}$		1	3	$\mu\text{V}/\text{V}$
INPUT BIAS CURRENT						
I_B	Input bias current	$V_{CM} = 0\text{ V}$		600	1200	nA
I_{OS}	Input offset current	$V_{CM} = 0\text{ V}$		± 25	± 100	nA
INPUT VOLTAGE						
V_{CM}	Common-mode voltage		$(V-) + 0.5$		$(V+) - 1$	V
CMRR	Common-mode rejection ratio		106	114		dB
INPUT IMPEDANCE						
	Differential resistance			170		k Ω
	Differential capacitance			2		pF
	Common-mode resistance			600		k Ω
	Common-mode capacitance			2.5		pF
OPEN-LOOP GAIN						
A_{OL}	Open-loop voltage gain	$(V-) + 0.6\text{ V} \leq V_O \leq (V+) - 0.6\text{ V}$, $R_L = 2\text{ k}\Omega$	106	114		dB
OUTPUT						
V_{OUT}	Output voltage	$R_L = 2\text{ k}\Omega$	$(V-) + 0.6$		$(V+) - 0.6$	V
I_{OUT}	Output current		See Typical Characteristics			mA
Z_O	Open-loop output impedance		See Typical Characteristics			Ω
I_{SC}	Short-circuit current ⁽³⁾			± 50		mA
C_{LOAD}	Capacitive load drive			200		pF
POWER SUPPLY						
V_S	Specified voltage		± 1.5		± 18	V
I_Q	Quiescent current (per channel)	$I_{OUT} = 0\text{ A}$		1.5	1.8	mA
		$I_{OUT} = 0\text{ A}$, $T_A = -40^\circ\text{C to } 85^\circ(2)$			2	mA
TEMPERATURE						
	Specified temperature		-40		85	$^\circ\text{C}$

(2) Specified by design and characterization.

(3) One channel at a time.

7.6 Electrical Characteristics: $V_S = 5\text{ V}$
 $T_A = 25^\circ\text{C}$, $V_{CM} = V_{OUT} = \text{midsupply}$, and $R_L = 2\text{ k}\Omega$ (unless otherwise noted)

PARAMETER/TEST		CONDITIONS	MIN	TYP	MAX	UNIT
AUDIO PERFORMANCE						
THD+N	Total harmonic distortion + noise	$G = 1$, $f = 1\text{ kHz}$, $V_O = 3\text{ V}_{RMS}$		0.0001%		
				-120		dB
IMD	Intermodulation distortion	$G = 1$, $V_O = 3\text{ V}_{RMS}$	SMPTE two-tone, 4:1 (60 Hz and 7 kHz)	0.00004%		
				-128		dB
			DIM 30 (3-kHz square wave and 15-kHz sine wave)	0.00004%		
			-128		dB	
				0.00004%		
				-128		dB

Electrical Characteristics: $V_S = 5\text{ V}$ (continued)
 $T_A = 25^\circ\text{C}$, $V_{CM} = V_{OUT} = \text{midsupply}$, and $R_L = 2\text{ k}\Omega$ (unless otherwise noted)

PARAMETER/TEST		CONDITIONS	MIN	TYP	MAX	UNIT
FREQUENCY RESPONSE						
GBW	Gain-bandwidth product	$G = 1$		20		MHz
SR	Slew rate	$G = -1$		13		V/ μs
	Full power bandwidth ⁽¹⁾	$V_O = 1\text{ V}_P$		2		MHz
	Overload recovery time	$G = -10$		1		μs
	Channel separation (dual and quad)	$f = 1\text{ kHz}$		-120		dB
NOISE						
e_n	Input voltage noise	$f = 20\text{ Hz to } 20\text{ kHz}$		3.3		μV_{PP}
	Input voltage noise density	$f = 1\text{ kHz}$		3.3		$\text{nV}/\sqrt{\text{Hz}}$
		$f = 100\text{ Hz}$		5		$\text{nV}/\sqrt{\text{Hz}}$
i_n	Input current noise density	$f = 1\text{ kHz}$		1		$\text{pA}/\sqrt{\text{Hz}}$
		$f = 100\text{ Hz}$		2		$\text{pA}/\sqrt{\text{Hz}}$
OFFSET VOLTAGE						
V_{OS}	Input offset voltage	$V_S = \pm 1.5\text{ V to } \pm 18\text{ V}$		± 0.5	± 1.5	mV
		$V_S = \pm 1.5\text{ V to } \pm 18\text{ V}$, $T_A = -40^\circ\text{C to } 85^\circ\text{C}$ ⁽²⁾		2	8	$\mu\text{V}/^\circ\text{C}$
PSRR	Power-supply rejection ratio	$V_S = \pm 1.5\text{ V to } \pm 18\text{ V}$		1	3	$\mu\text{V}/\text{V}$
INPUT BIAS CURRENT						
I_B	Input bias current	$V_{CM} = 0\text{ V}$		600	1200	nA
I_{OS}	Input offset current	$V_{CM} = 0\text{ V}$		± 25	± 100	nA
INPUT VOLTAGE						
V_{CM}	Common-mode voltage		(V-) + 0.5		(V+) - 1	V
CMRR	Common-mode rejection ratio		86	100		dB
INPUT IMPEDANCE						
	Differential resistance			170		k Ω
	Differential capacitance			2		pF
	Common-mode resistance			600		k Ω
	Common-mode capacitance			2.5		pF
OPEN-LOOP GAIN						
A_{OL}	Open-loop voltage gain	$(V-) + 0.6\text{ V} \leq V_O \leq (V+) - 0.6\text{ V}$, $R_L = 2\text{ k}\Omega$	90	100		dB
OUTPUT						
V_{OUT}	Output voltage	$R_L = 2\text{ k}\Omega$	(V-) + 0.6		(V+) - 0.6	V
I_{OUT}	Output current			See 1		mA
Z_O	Open-loop output impedance			See Typical Characteristics		Ω
I_{SC}	Short-circuit current ⁽³⁾			± 40		mA
C_{LOAD}	Capacitive load drive			200		pF
POWER SUPPLY						
V_S	Specified voltage		± 1.5		± 18	V
I_Q	Quiescent current (per channel)	$I_{OUT} = 0\text{ A}$		1.4	1.7	mA
		$I_{OUT} = 0\text{ A}$, $T_A = -40^\circ\text{C to } 85^\circ\text{C}$ ⁽²⁾			2	mA
TEMPERATURE						
	Specified temperature		-40		85	$^\circ\text{C}$

- (1) Full-power bandwidth = $\text{SR} / (2\pi \times V_P)$, where SR = slew rate.
- (2) Specified by design and characterization.
- (3) One channel at a time.

7.7 Typical Characteristics

At $T_A = 25^\circ\text{C}$, $V_S = \pm 15\text{ V}$, and $R_L = 2\text{ k}\Omega$ (unless otherwise noted)

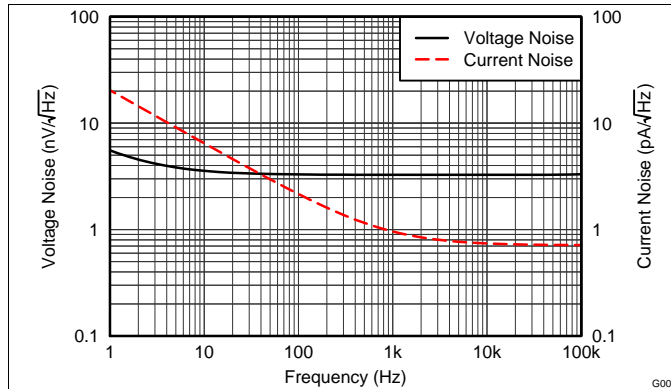

Figure 1. Input Voltage Noise Density and Input Current Noise Density vs Frequency

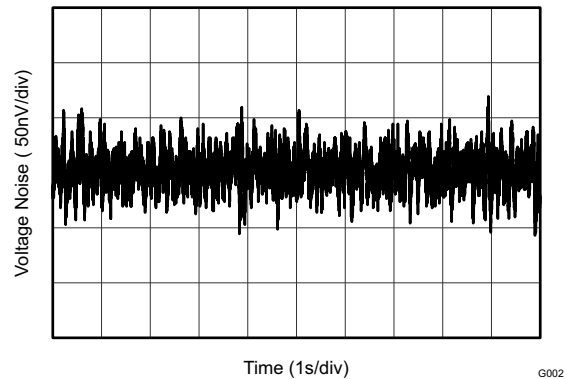

Figure 2. 0.1-Hz to 10-Hz Noise

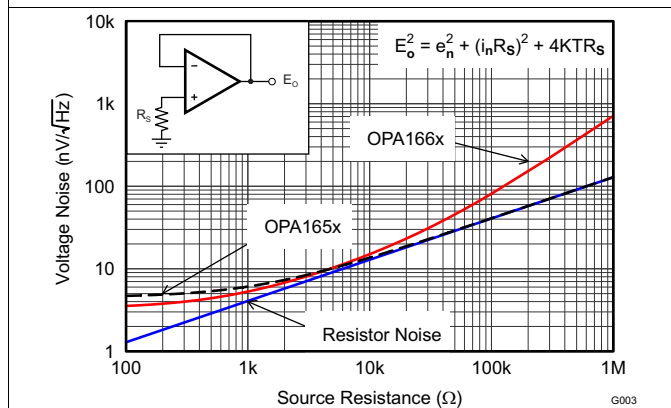

Figure 3. Voltage Noise vs Source Resistance

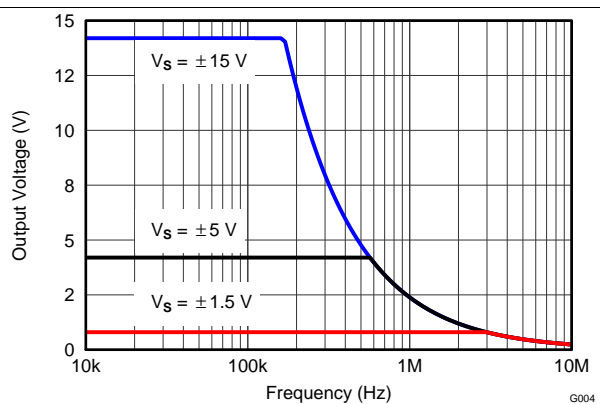

Figure 4. Maximum Output Voltage vs Frequency

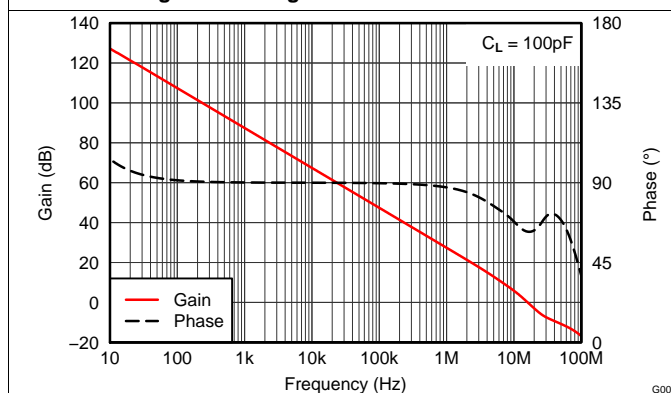

Figure 5. Gain and Phase vs Frequency

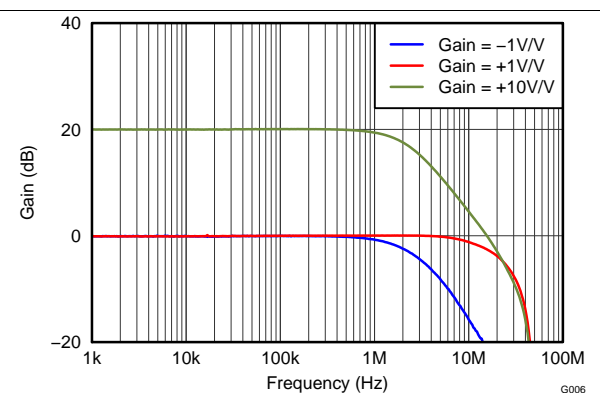
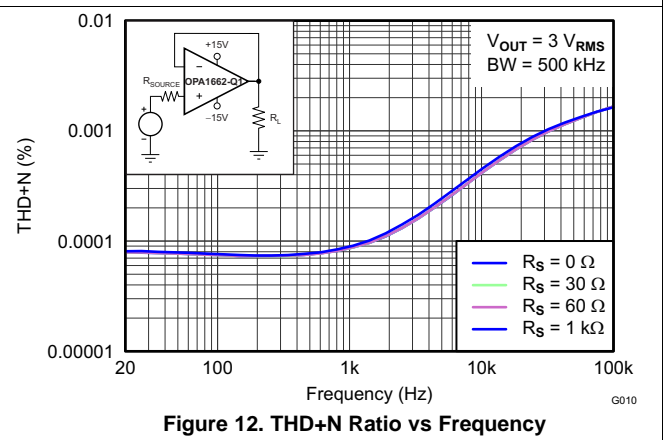
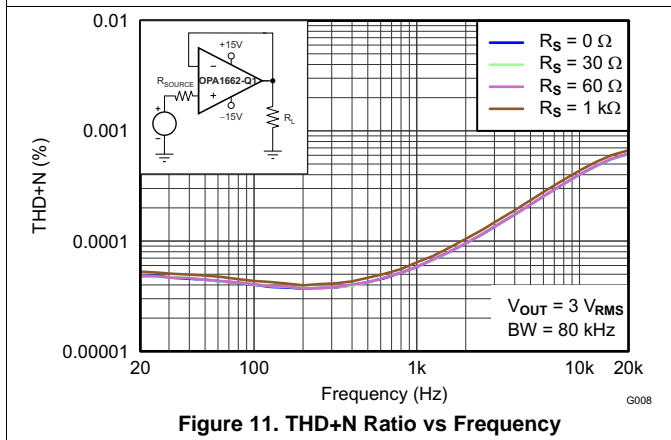
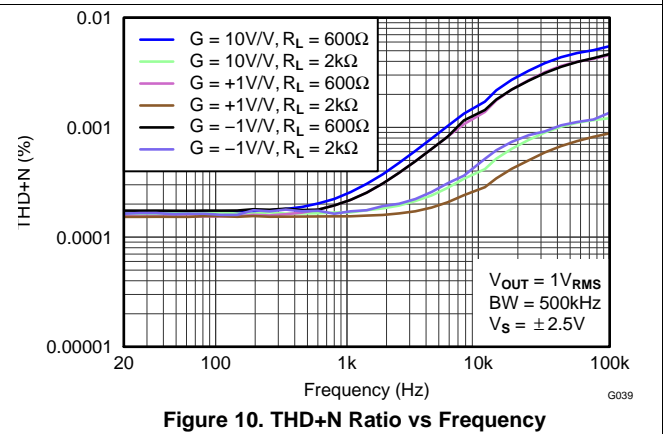
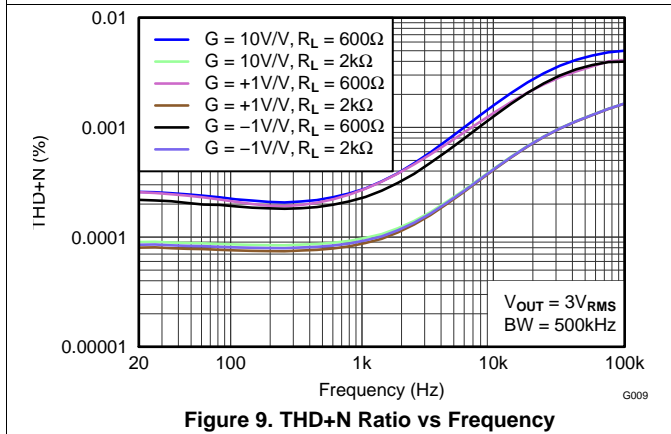
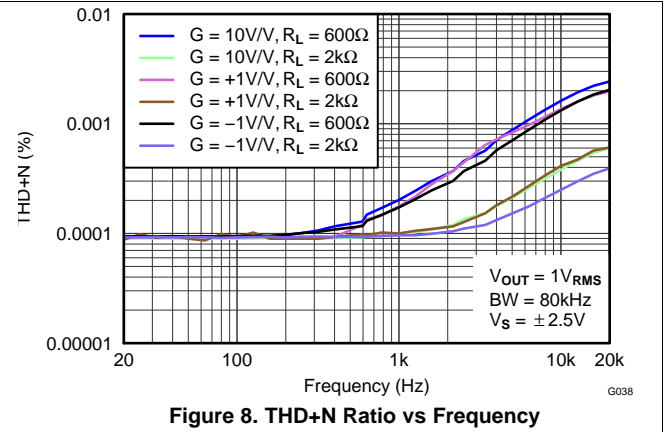
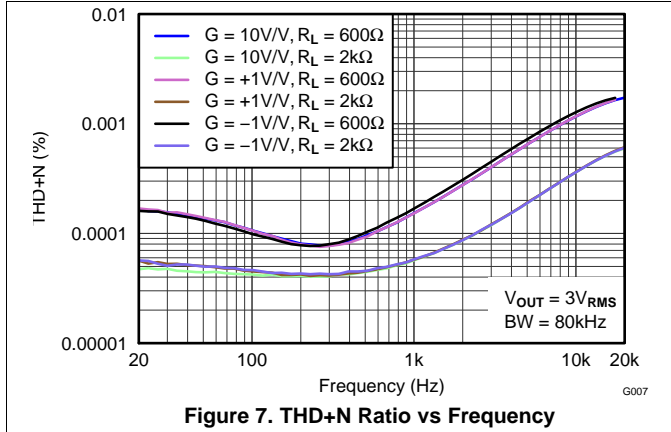

Figure 6. Closed-Loop Gain vs Frequency

Typical Characteristics (continued)

At $T_A = 25^\circ\text{C}$, $V_S = \pm 15\text{ V}$, and $R_L = 2\text{ k}\Omega$ (unless otherwise noted)



Typical Characteristics (continued)

At $T_A = 25^\circ\text{C}$, $V_S = \pm 15\text{ V}$, and $R_L = 2\text{ k}\Omega$ (unless otherwise noted)

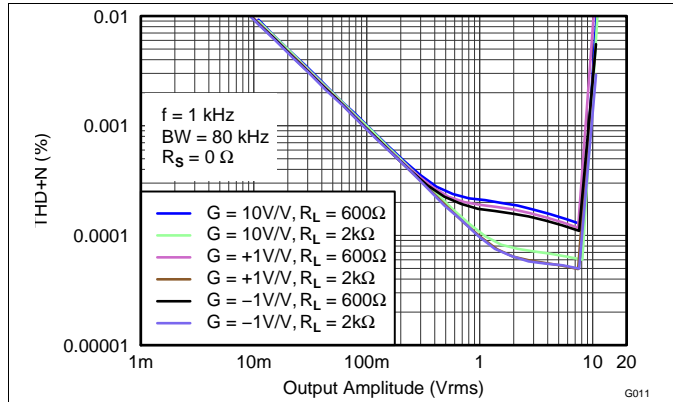

Figure 13. THD+N Ratio vs Output Amplitude

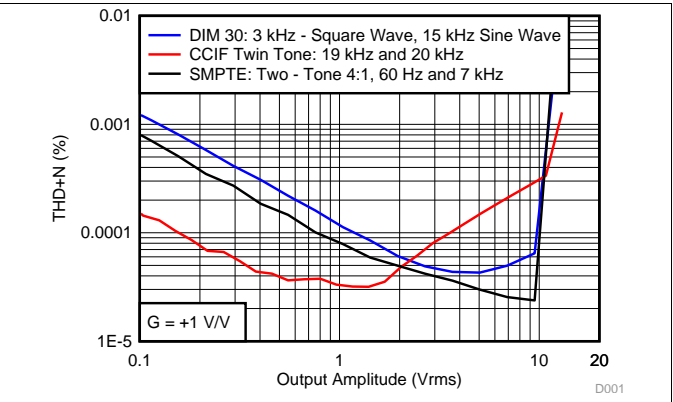

Figure 14. Intermodulation Distortion vs Output Amplitude

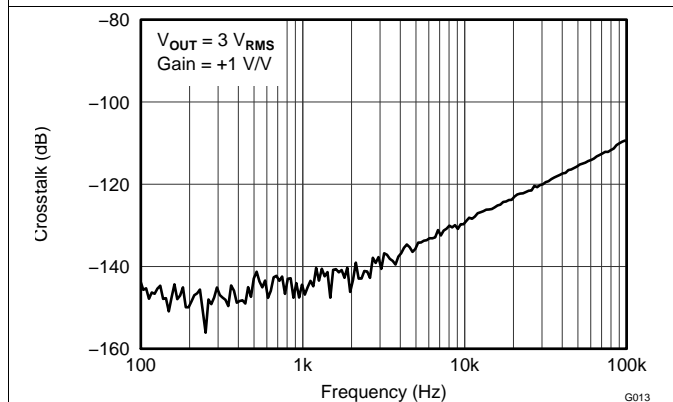

Figure 15. Channel Separation vs Frequency

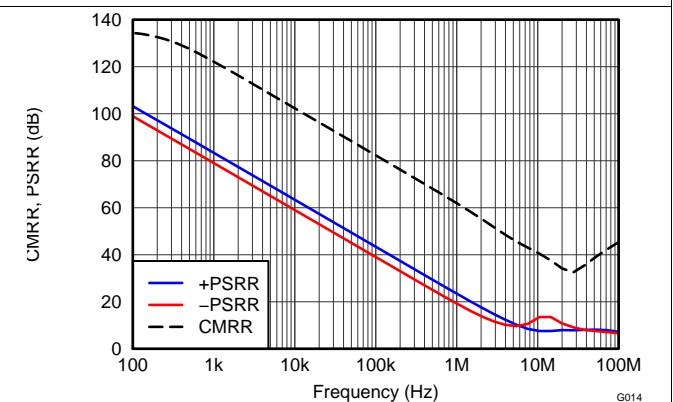

Figure 16. CMRR and PSRR vs Frequency (Referred to Input)

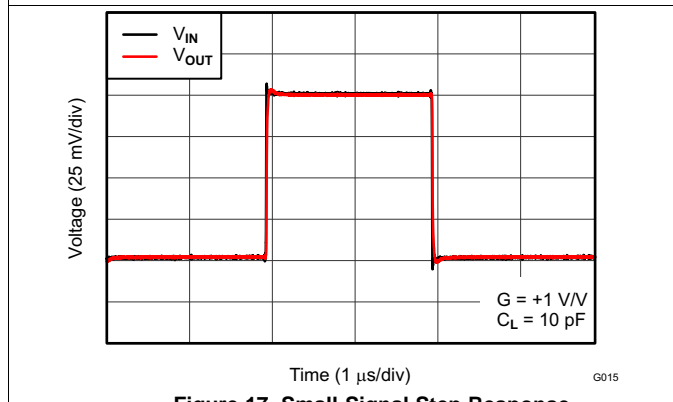

Figure 17. Small-Signal Step Response

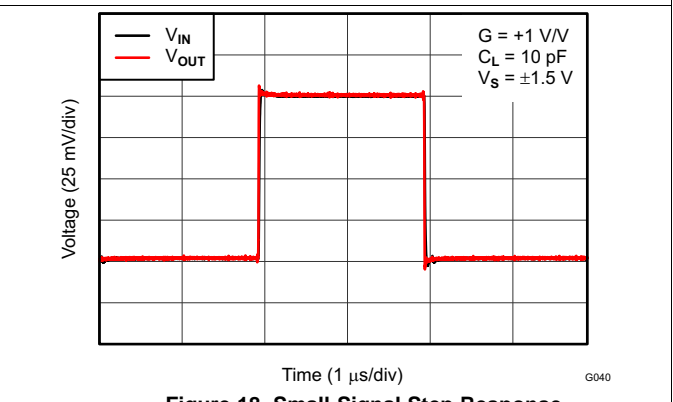

Figure 18. Small-Signal Step Response

Typical Characteristics (continued)

At $T_A = 25^\circ\text{C}$, $V_S = \pm 15\text{ V}$, and $R_L = 2\text{ k}\Omega$ (unless otherwise noted)

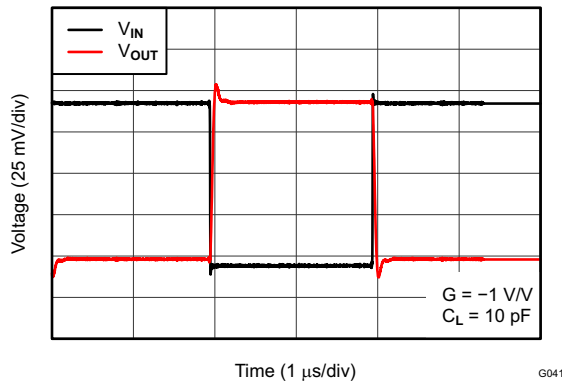

Figure 19. Small-Signal Step Response

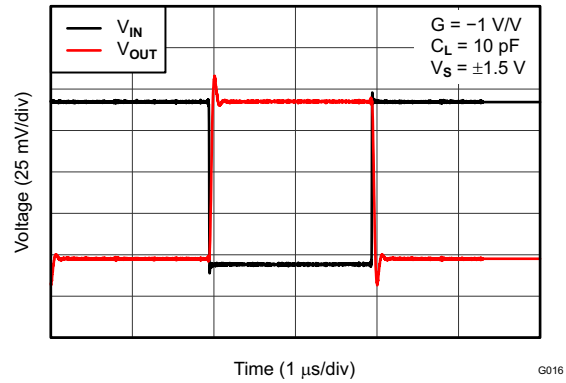

Figure 20. Small-Signal Step Response

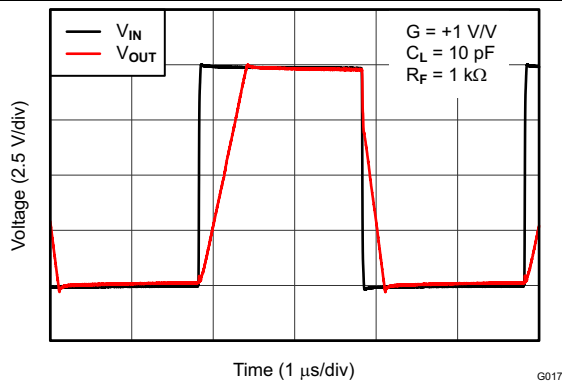

Figure 21. Large-Signal Step Response

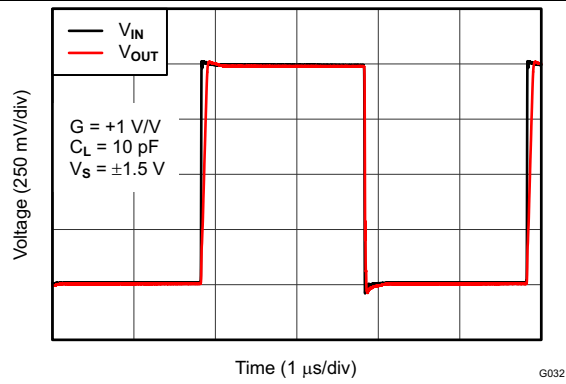

Figure 22. Large-Signal Step Response

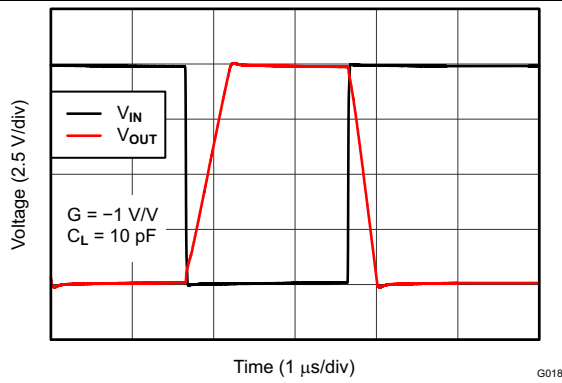

Figure 23. Large-Signal Step Response

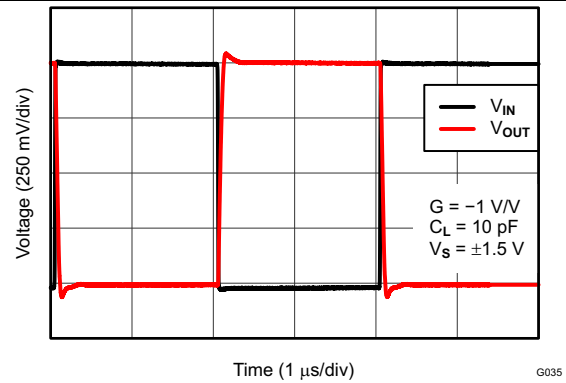

Figure 24. Large-Signal Step Response

Typical Characteristics (continued)

At $T_A = 25^\circ\text{C}$, $V_S = \pm 15\text{ V}$, and $R_L = 2\text{ k}\Omega$ (unless otherwise noted)

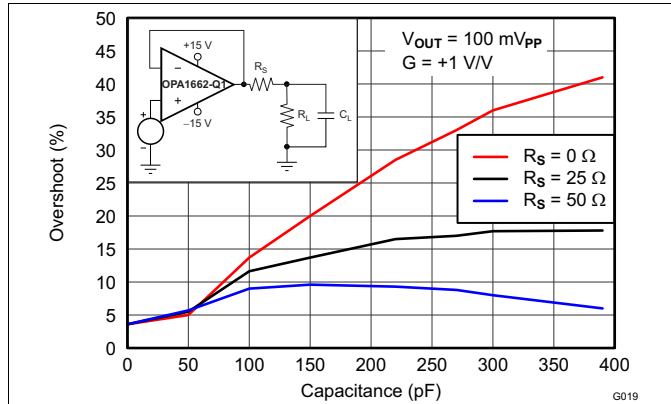

Figure 25. Small-Signal Overshoot vs Capacitive Load

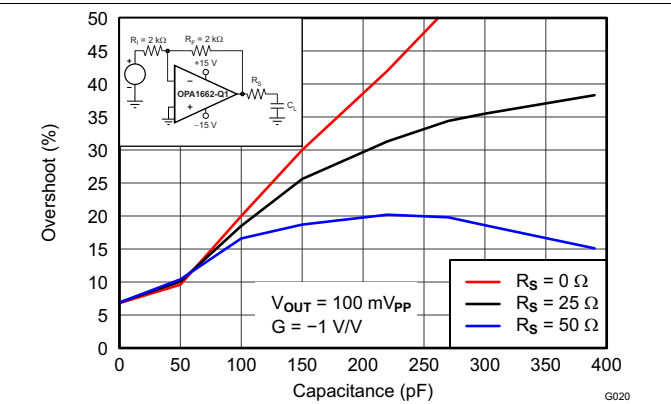

Figure 26. Small-Signal Overshoot vs Capacitive Load

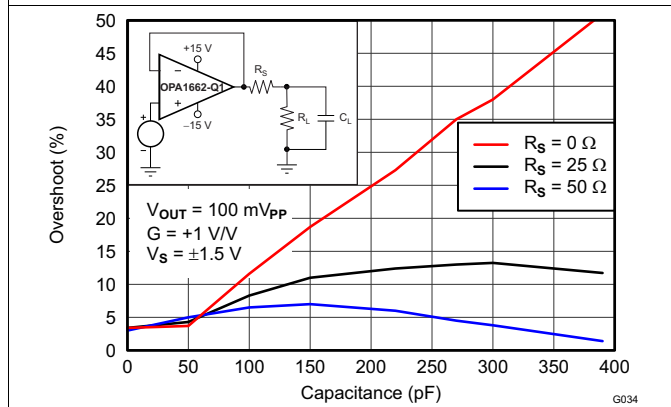

Figure 27. Small-Signal Overshoot vs Capacitive Load

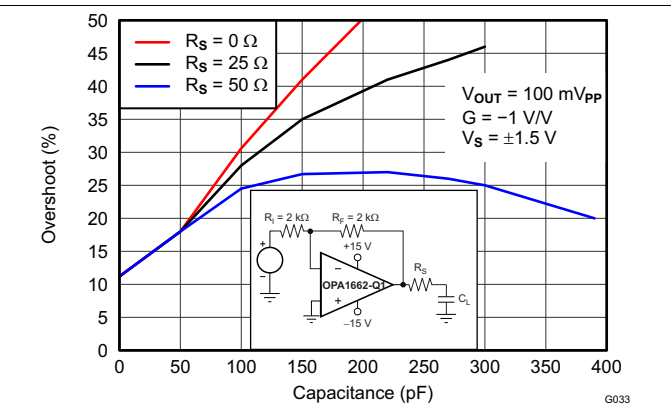

Figure 28. Small-Signal Overshoot vs Capacitive Load

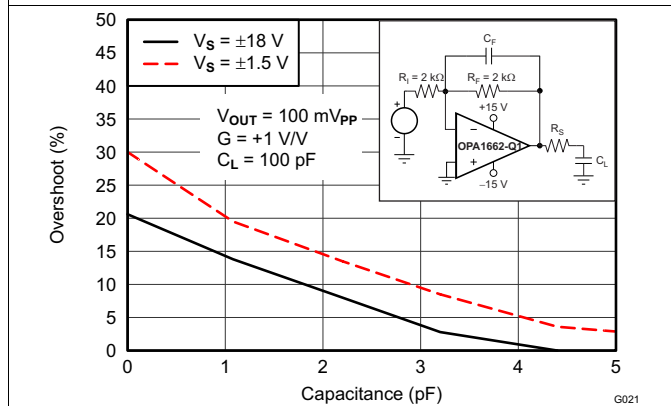

Figure 29. Small-Signal Overshoot vs Feedback Capacitor

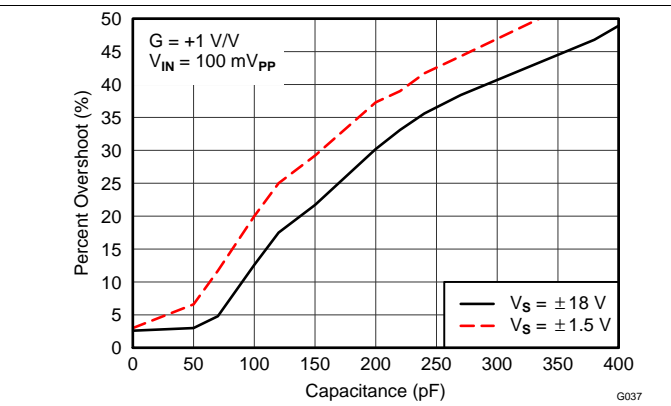

Figure 30. Percent Overshoot vs Capacitive Load

Typical Characteristics (continued)

At $T_A = 25^\circ\text{C}$, $V_S = \pm 15\text{ V}$, and $R_L = 2\text{ k}\Omega$ (unless otherwise noted)

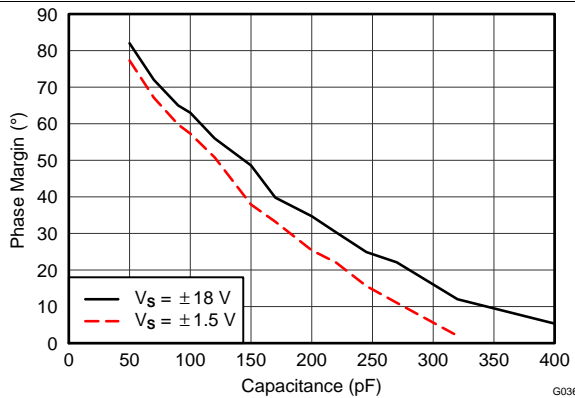

Figure 31. Phase Margin vs Capacitive Load

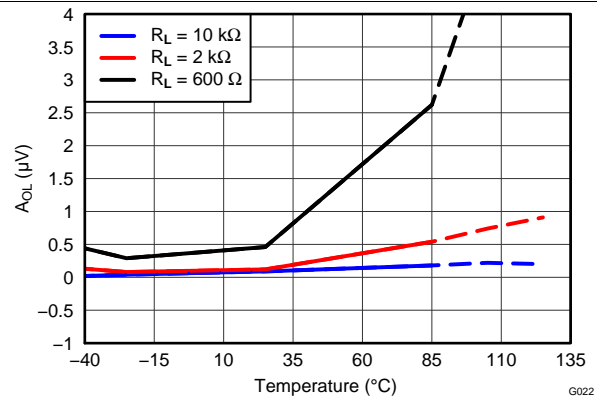

Figure 32. Open-Loop Gain vs Temperature

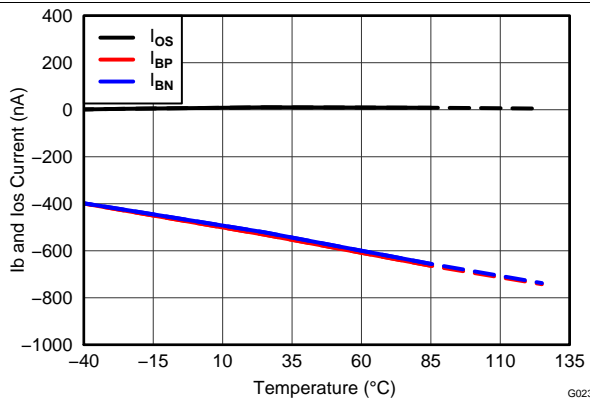

Figure 33. I_B and I_{OS} vs Temperature

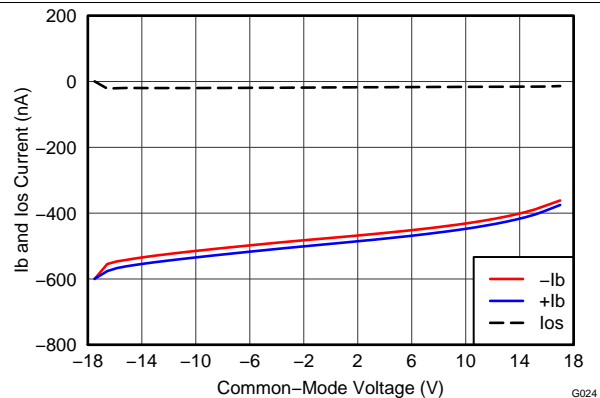

Figure 34. I_B and I_{OS} vs Common-Mode Voltage

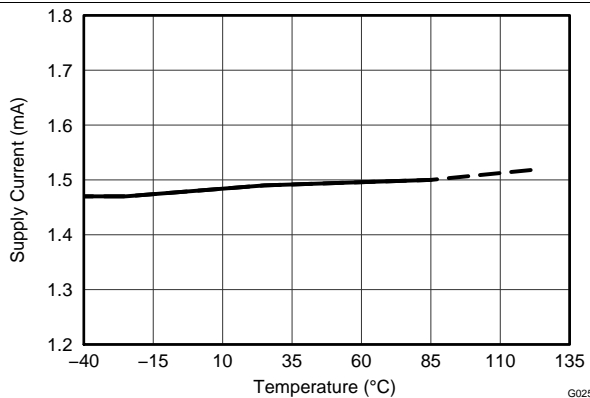

Figure 35. Supply Current vs Temperature

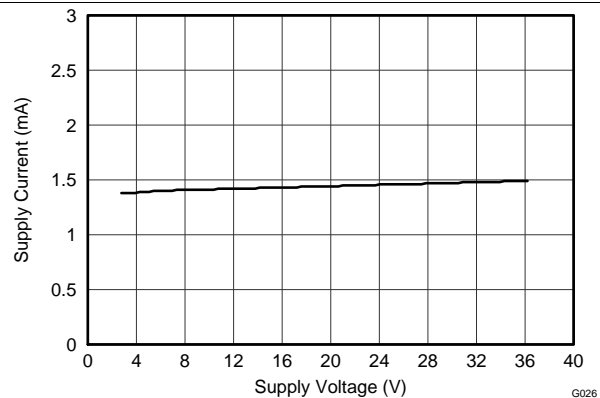

Figure 36. Supply Current vs Supply Voltage

Typical Characteristics (continued)

At $T_A = 25^\circ\text{C}$, $V_S = \pm 15\text{ V}$, and $R_L = 2\text{ k}\Omega$ (unless otherwise noted)

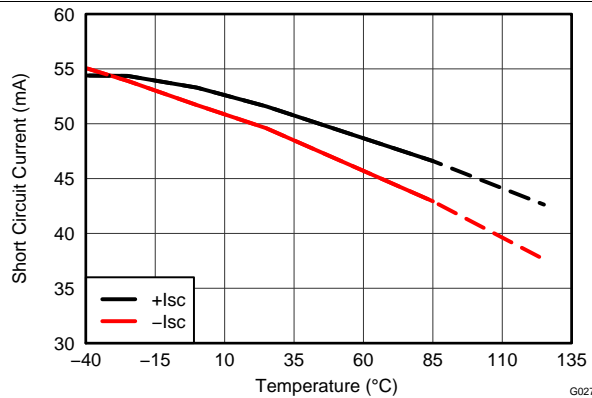

Figure 37. Short-Circuit Current vs Temperature

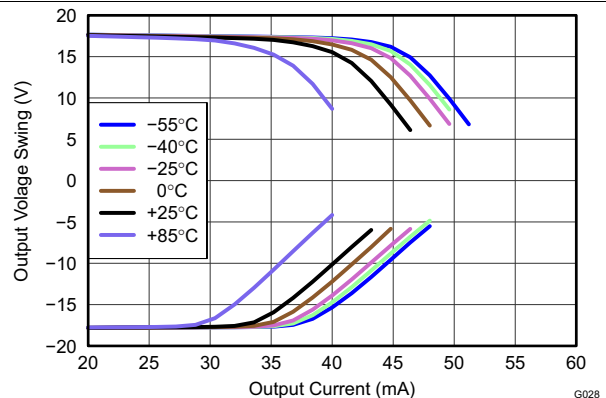

Figure 38. Output Voltage vs Output Current

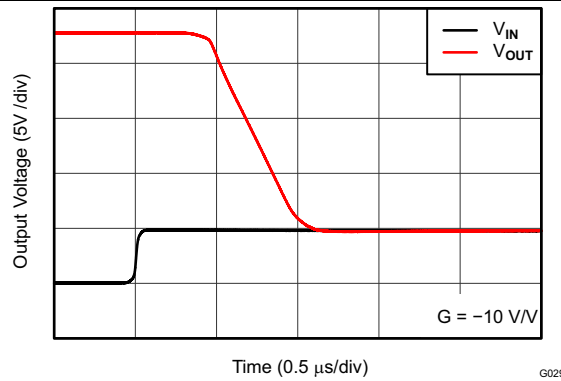

Figure 39. Positive Overload Recovery

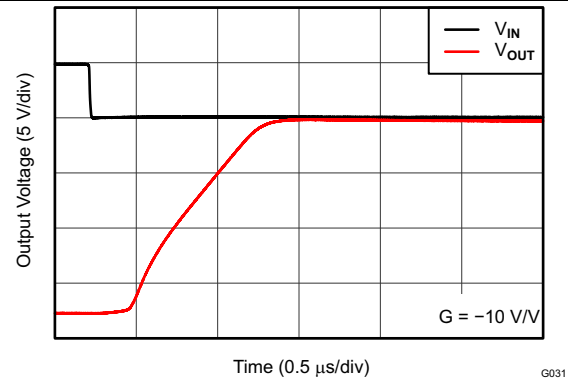

Figure 40. Negative Overload Recovery

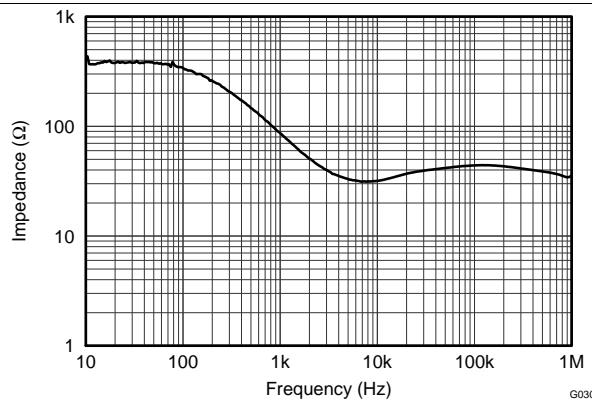

Figure 41. Open-Loop Output Impedance vs Frequency

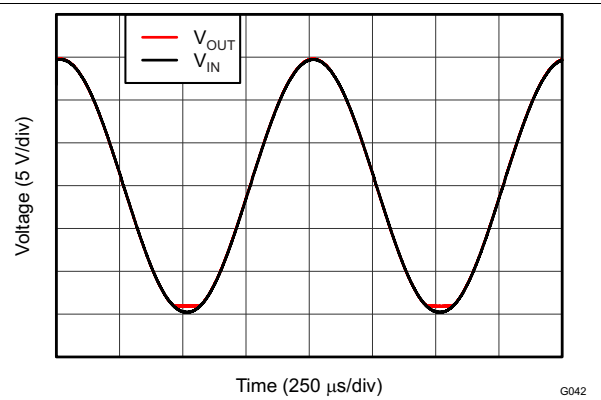

Figure 42. No Phase Reversal

8 Detailed Description

8.1 Overview

The OPA1662-Q1 operational amplifier achieves a low $3.3 \text{ nV}/\sqrt{\text{Hz}}$ noise density with an ultra-low distortion of 0.00006% at 1 kHz that makes the device suitable for audio application. This device has a wide supply range with excellent PSRR, making it a suitable option for applications that are battery powered without regulation.

8.2 Functional Block Diagram

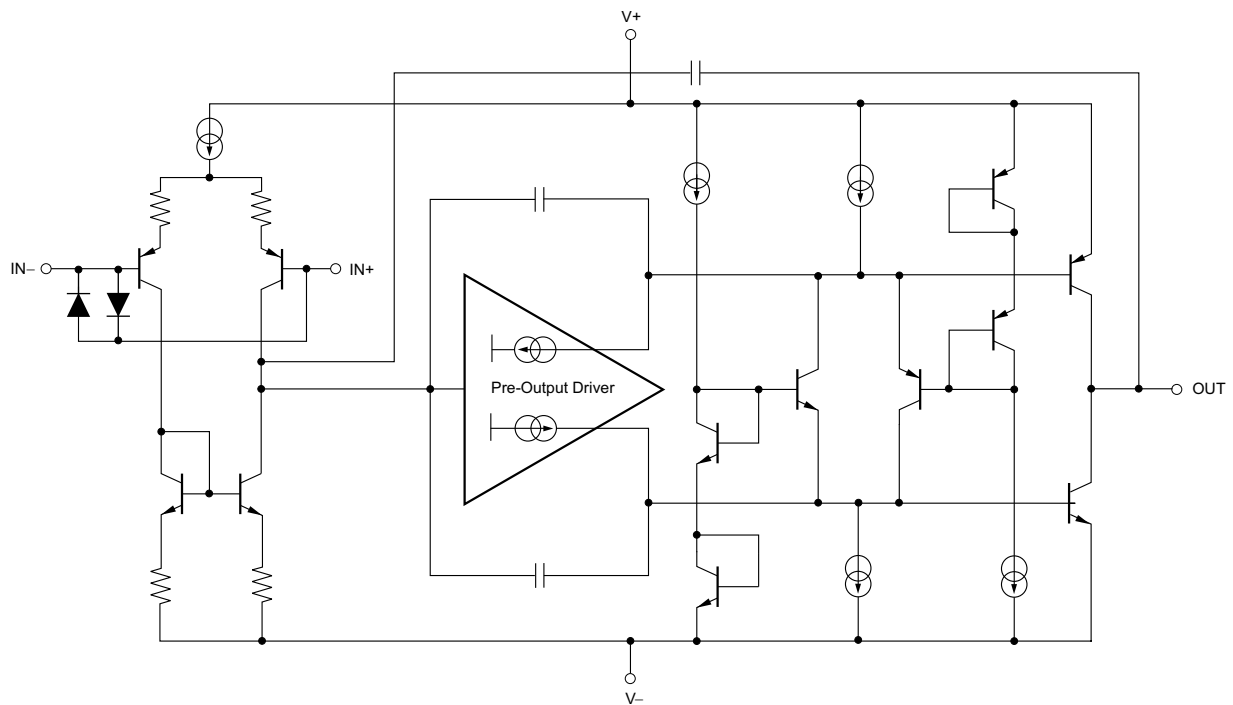

Copyright © 2016, Texas Instruments Incorporated

Figure 43. OPA1662-Q1 Simplified Schematic

8.3 Feature Description

8.3.1 Operating Voltage

The OPA1662-Q1 op amp operates from $\pm 1.5\text{-V}$ to $\pm 18\text{-V}$ supplies while maintaining excellent performance. The OPA1662-Q1 can operate with as little as 3 V between the supplies and up to 36 V between the supplies. However, some applications do not require equal positive and negative output voltage swing. With the OPA1662-Q1 device, power-supply voltages do not need to be equal. For example, the positive supply could be set to 25 V with the negative supply at -5 V .

In all cases, the common-mode voltage must be maintained within the specified range. In addition, key parameters are assured over the specified temperature of $T_A = -40^\circ\text{C}$ to 85°C . Parameters that vary significantly with operating voltage or temperature are shown in the [Typical Characteristics](#).

Feature Description (continued)

8.3.2 Input Protection

The input terminals of the OPA1662-Q1 are protected from excessive differential voltage with back-to-back diodes, as Figure 44 illustrates. In most circuit applications, the input protection circuitry has no consequence. However, in low-gain or $G = 1$ circuits, fast ramping input signals can forward bias these diodes because the output of the amplifier cannot respond rapidly enough to the input ramp. If the input signal is fast enough to create this forward bias condition, the input signal current must be limited to 10 mA or less. If the input signal current is not inherently limited, an input series resistor (R_I) or a feedback resistor (R_F) can be used to limit the signal input current. This resistor degrades the low-noise performance of the OPA1662-Q1 and is examined in [Noise Performance](#). Figure 44 shows an example configuration when both current-limiting input and feedback resistors are used.

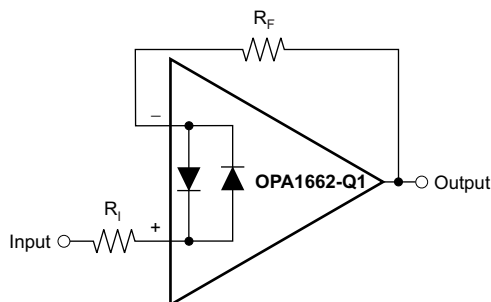
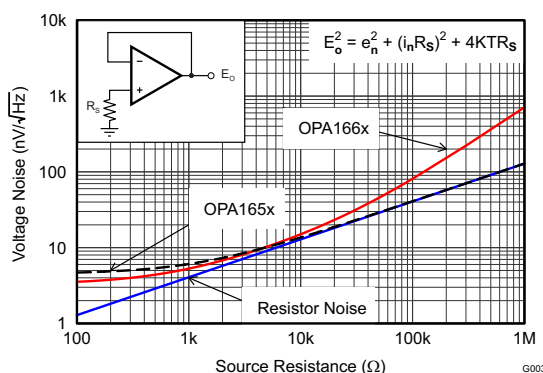

Figure 44. Pulsed Operation

8.3.3 Noise Performance

Figure 45 shows the total circuit noise for varying source impedances with the op amp in a unity-gain configuration (no feedback resistor network, and therefore no additional noise contributions).

The OPA1662-Q1 ($GBW = 22$ MHz, $G = 1$) is shown with total circuit noise calculated. The op amp itself contributes both a voltage noise component and a current noise component. The voltage noise is commonly modeled as a time-varying component of the offset voltage. The current noise is similarly modeled as the time-varying component of the input bias current and reacts with the source resistance to create a voltage component of noise. Therefore, the lowest noise op amp for a given application depends on the source impedance. For low source impedance, current noise is negligible, and voltage noise generally dominates. The low voltage noise of the OPA1662-Q1 op amp makes them a better choice for low source impedances of less than 1 k Ω .



The equation calculates total circuit noise, where:

- e_n is the voltage noise
- i_n is the current noise
- R_S is the source impedance
- k is Boltzmann's constant = 1.38×10^{-23} J/K
- T is the temperature in Kelvins (K)

Figure 45. Noise Performance of the OPA1662-Q1 in Unity-Gain Buffer Configuration

Feature Description (continued)

8.3.4 Basic Noise Calculations

Design of low-noise op amp circuits requires careful consideration of a variety of possible noise contributors: noise from the signal source, noise generated in the op amp, and noise from the feedback network resistors. The total noise of the circuit is the root-sum-square combination of all noise components.

The resistive portion of the source impedance produces thermal noise proportional to the square root of the resistance. [Figure 45](#) plots this equation. The source impedance is usually fixed; consequently, select the op amp and the feedback resistors to minimize the respective contributions to the total noise.

[Figure 46](#) illustrates both inverting and noninverting op amp circuit configurations with gain. In circuit configurations with gain, the feedback network resistors also contribute noise. The current noise of the op amp reacts with the feedback resistors to create additional noise components. The feedback resistor values can generally be chosen to make these noise sources negligible. The equations for total noise are shown for both configurations.

A) Noise in Noninverting Gain Configuration

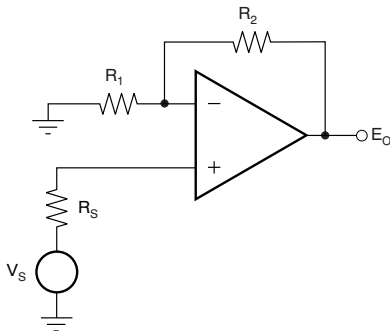

Noise at the output:

$$E_o^2 = \left(1 + \frac{R_2}{R_1}\right)^2 e_n^2 + \left(\frac{R_2}{R_1}\right)^2 e_1^2 + e_2^2 + \left(1 + \frac{R_2}{R_1}\right)^2 e_s^2$$

Where $e_s = \sqrt{4kTR_s}$ = thermal noise of R_s

$e_1 = \sqrt{4kTR_1}$ = thermal noise of R_1

$e_2 = \sqrt{4kTR_2}$ = thermal noise of R_2

B) Noise in Inverting Gain Configuration

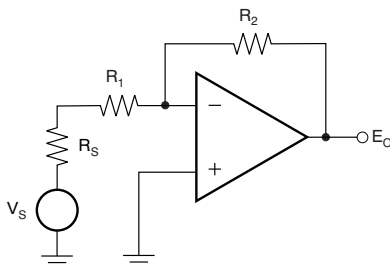

Noise at the output:

$$E_o^2 = \left(1 + \frac{R_2}{R_1 + R_s}\right)^2 e_n^2 + \left(\frac{R_2}{R_1 + R_s}\right)^2 e_1^2 + e_2^2 + \left(\frac{R_2}{R_1 + R_s}\right)^2 e_s^2$$

Where $e_s = \sqrt{4kTR_s}$ = thermal noise of R_s

$e_1 = \sqrt{4kTR_1}$ = thermal noise of R_1

$e_2 = \sqrt{4kTR_2}$ = thermal noise of R_2

For the OPA1662-Q1 op amp at 1 kHz, $e_n = 3.3 \text{ nV}/\sqrt{\text{Hz}}$.

Figure 46. Noise Calculation in Gain Configurations

8.3.5 Total Harmonic Distortion Measurements

The OPA1662-Q1 op amp has excellent distortion characteristics. THD + noise is below 0.0006% ($G = 1$, $V_O = 3 \text{ V}_{\text{RMS}}$, $\text{BW} = 80 \text{ kHz}$) throughout the audio frequency range, 20 Hz to 20 kHz, with a 2-k Ω load (see [Figure 7](#) for characteristic performance).

The distortion produced by the OPA1662-Q1 op amp is below the measurement limit of many commercially available distortion analyzers. However, a special test circuit (such as [Figure 47](#) shows) can be used to extend the measurement capabilities.

Op amp distortion can be considered an internal error source that can be referred to the input. Figure 47 shows a circuit that causes the op amp distortion to be gained up (see the table in Figure 47 for the distortion gain factor for various signal gains). The addition of R_3 to the otherwise standard noninverting amplifier configuration alters the feedback factor or noise gain of the circuit. The closed-loop gain is unchanged, but the feedback available for error correction is reduced by the distortion gain factor, thus extending the resolution by the same amount. The input signal and load applied to the op amp are the same as with conventional feedback without R_3 . The value of R_3 must be kept small to minimize its effect on the distortion measurements.

The validity of this technique can be verified by duplicating measurements at high gain or high frequency where the distortion is within the measurement capability of the test equipment. Measurements for this data sheet were made with an Audio Precision System Two distortion and noise analyzer, which greatly simplifies such repetitive measurements. The measurement technique can, however, be performed with manual distortion measurement instruments.

8.3.6 Capacitive Loads

The dynamic characteristics of the OPA1662-Q1 have been optimized for commonly encountered gains, loads, and operating conditions. The combination of low closed-loop gain and high capacitive loads decreases the phase margin of the amplifier and can lead to gain peaking or oscillations. As a result, heavier capacitive loads must be isolated from the output. The simplest way to achieve this isolation is to add a small resistor (R_S equal to 50 Ω , for example) in series with the output.

This small series resistor also prevents excess power dissipation if the output of the device becomes shorted. Figure 25 illustrates a graph of *Small-Signal Overshoot vs Capacitive Load* for several values of R_S . Also see *Applications Bulletin: Feedback Plots Define Op Amp AC Performance* for details of analysis techniques and application circuits.

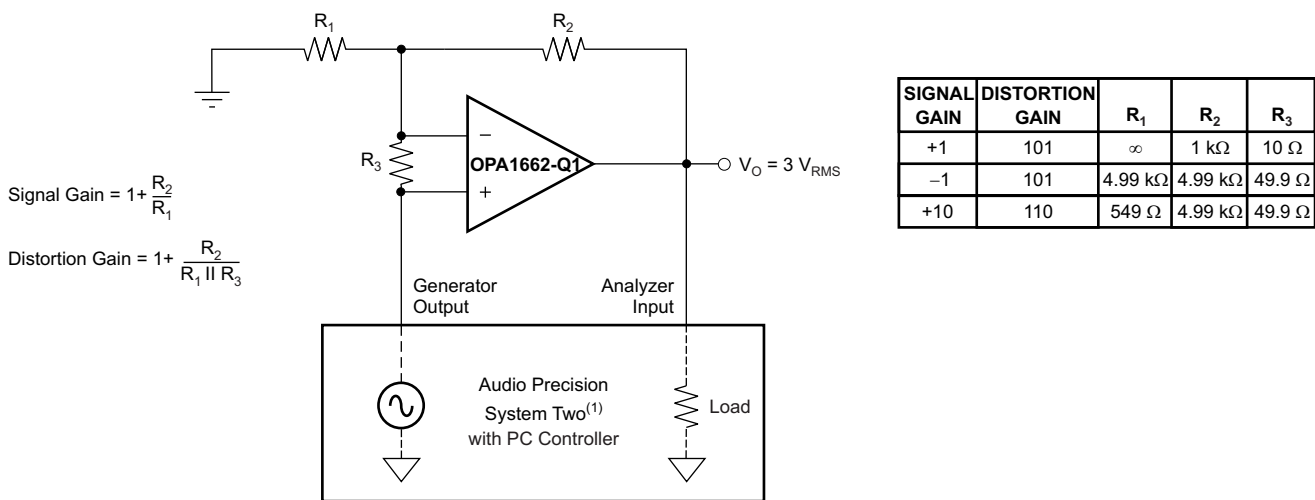

(1) For measurement bandwidth, see Figure 7 through Figure 12.

Figure 47. Distortion Test Circuit

8.3.7 Electrical Overstress

Designers often ask questions about the capability of an operational amplifier to withstand electrical overstress. These questions tend to focus on the device inputs, but may involve the supply voltage pins or even the output pin. Each of these different pin functions have electrical stress limits determined by the voltage breakdown characteristics of the particular semiconductor fabrication process and specific circuits connected to the pin. Additionally, internal electrostatic discharge (ESD) protection is built into these circuits to protect them from accidental ESD events both before and during product assembly.

It is helpful to have a good understanding of this basic ESD circuitry and its relevance to an electrical overstress event. Figure 48 illustrates the ESD circuits contained in the OPA1662-Q1 (indicated by the dashed line area). The ESD protection circuitry involves several current-steering diodes connected from the input and output pins and routed back to the internal power-supply lines, where they meet at an absorption device internal to the operational amplifier. This protection circuitry is intended to remain inactive during normal circuit operation.

An ESD event produces a short duration, high-voltage pulse that is transformed into a short duration, high-current pulse as it discharges through a semiconductor device. The ESD protection circuits are designed to provide a current path around the operational amplifier core to prevent it from being damaged. The energy absorbed by the protection circuitry is then dissipated as heat.

When an ESD voltage develops across two or more of the amplifier device pins, current flows through one or more of the steering diodes. Depending on the path that the current takes, the absorption device may activate. The absorption device internal to the OPA1662-Q1 triggers when a fast ESD voltage pulse is impressed across the supply pins. Once triggered, it quickly activates, clamping the ESD pulse to a safe voltage level.

When the operational amplifier connects into a circuit such as that illustrated in [Figure 48](#), the ESD protection components are intended to remain inactive and not become involved in the application circuit operation. However, circumstances may arise where an applied voltage exceeds the operating voltage range of a given pin. If this condition occurs, there is a risk that some of the internal ESD protection circuits may be biased on, and conduct current. Any such current flow occurs through steering diode paths and rarely involves the absorption device.

[Figure 48](#) depicts a specific example where the input voltage, V_{IN} , exceeds the positive supply voltage ($+V_S$) by 500 mV or more. Much of what happens in the circuit depends on the supply characteristics. If $+V_S$ can sink the current, one of the upper input steering diodes conducts and directs current to $+V_S$. Excessively high current levels can flow with increasingly higher V_{IN} . As a result, TI recommends that applications limit the input current to 10 mA.

If the supply is not capable of sinking the current, V_{IN} may begin sourcing current to the operational amplifier, and then take over as the source of positive supply voltage. The danger in this case is that the voltage can rise to levels that exceed the operational amplifier absolute maximum ratings. In extreme but rare cases, the absorption device triggers on while $+V_S$ and $-V_S$ are applied. If this event happens, a direct current path is established between the $+V_S$ and $-V_S$ supplies. The power dissipation of the absorption device is quickly exceeded, and the extreme internal heating destroys the operational amplifier.

Another common question involves what happens to the amplifier if an input signal is applied to the input while the power supplies $+V_S$ or $-V_S$ are at 0 V. Again, it depends on the supply characteristic while at 0 V, or at a level below the input signal amplitude. If the supplies appear as high impedance, then the operational amplifier supply current may be supplied by the input source through the current steering diodes. This state is not a normal bias condition; the amplifier most likely will not operate normally. If the supplies are low impedance, then the current through the steering diodes can become quite high. The current level depends on the ability of the input source to deliver current, and any resistance in the input path.

If there is an uncertainty about the ability of the supply to absorb this current, external Zener diodes may be added to the supply pins as shown in [Figure 48](#).

The Zener voltage must be selected such that the diode does not turn on during normal operation. However, its Zener voltage must be low enough so that the Zener diode conducts if the supply pin begins to rise above the safe operating supply voltage level.

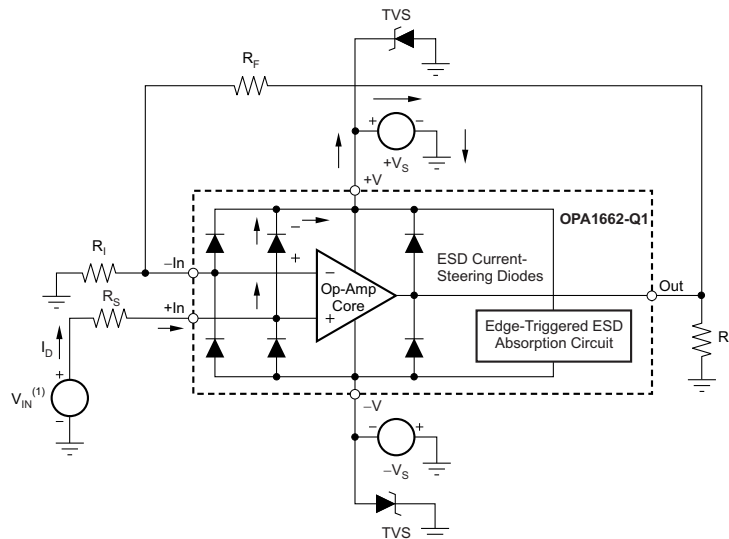

(1) $V_{IN} = +V_S + 500 \text{ mV}$.

Figure 48. Equivalent Internal ESD Circuitry and Its Relation to a Typical Circuit Application (Single Channel Shown)

8.4 Device Functional Modes

The OPA1662-Q1 has a single functional mode and is operational when the power-supply voltage is greater than 3 V (± 1.5 V). The maximum power supply voltage for the OPA1662-Q1 is 36 V (± 18 V).

9 Application and Implementation

NOTE

Information in the following applications sections is not part of the TI component specification, and TI does not warrant its accuracy or completeness. TI's customers are responsible for determining suitability of components for their purposes. Customers should validate and test their design implementation to confirm system functionality.

9.1 Application Information

The OPA1662-Q1 is a unity-gain stable, precision dual op amp with very low noise. Applications with noisy or high-impedance power supplies require decoupling capacitors close to the device pins. In most cases, 0.1- μF capacitors are adequate. Figure 43 shows a simplified schematic of the OPA1662-Q1 (one channel shown) while Figure 49 shows an additional application idea.

9.2 Typical Application

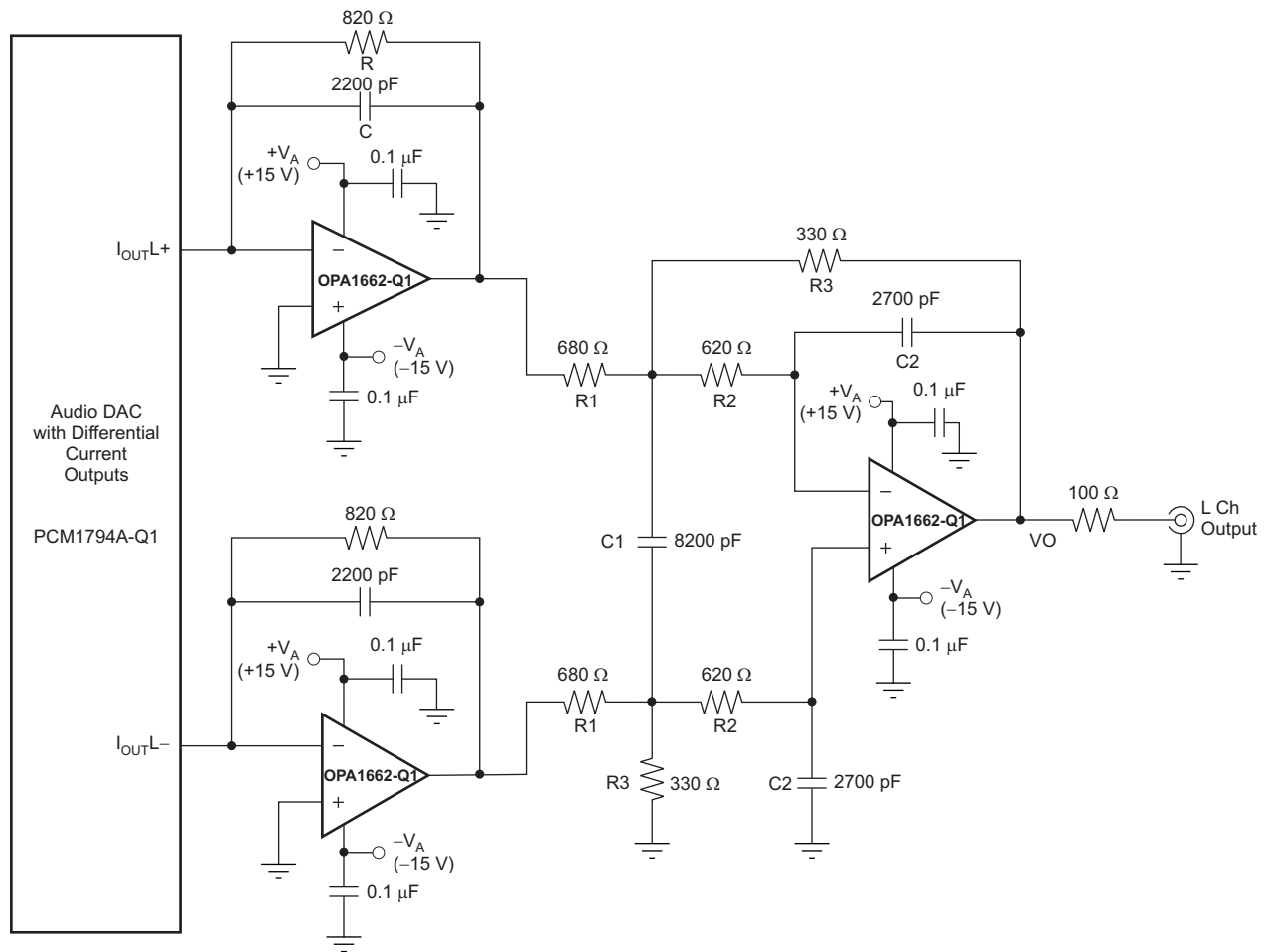

Copyright © 2016, Texas Instruments Incorporated

Figure 49. Audio DAC Current to Voltage Converter and Output Filter

Typical Application (continued)

9.2.1 Design Requirements

Table 1 lists the design parameters for this example.

Table 1. Design Parameters

PARAMETER	EXAMPLE VALUE
Supply voltage	±15 V to ±36 V
Differential input currents	0 mA to 30 mA
Resistors value tolerance	1%
Ceramic capacitor	XR5 or XR7 50 V

9.2.2 Detailed Design Procedure

This circuit is designed for converting differential input current into a single ended output voltage. The resistor values are chosen to be relatively low for minimizing the total circuit noise. The filtering capacitors are chosen to maintain adequate bandwidth from 10 Hz to 20 kHz for audio signals.

The first stage converts the audio DAC output current into a voltage with a gain calculated by Equation 1:

$$\frac{R}{1 + RCS}$$

where

- R = 820 Ω
- C = 2200 pF
- S is Laplace variable

(1)

RC filters the audio DAC output ripple and cutoff frequency = $\frac{1}{2\pi RC} = 80$ KHz

The second differential stage transfer function is calculated by Equation 2:

$$\frac{R3}{R1} \left(\frac{1}{1 + \frac{R2R3}{R1 // R2 // R3} C2S + 2R2R3C1C2S^2} \right)$$

(2)

The denominator of this transfer function $1 + \frac{R2R3}{R1 // R2 // R3} C2S + 2R2R3C1C2S^2$ is a quadratic equation and the general form is calculated by Equation 3:

$$1 + \frac{S}{Q\omega_0} + \frac{S^2}{Q\omega_0^2}$$

where

- $\omega_0 = 2\pi F_0$ is the resonance frequency
- and Q is the quality factor

(3)

The gain peak depends on the quality factor in Equation 4:

$$Q = R1 // R2 // R3 \sqrt{2 \frac{1}{R2R3} \times \frac{C1}{C2}}$$

(4)

The resonance frequency is calculated by Equation 5:

$$\omega_0 = 2\pi F_0 = \sqrt{\frac{1}{2R2R3C1C2}}$$

(5)

These equations help to maintain adequate bandwidth and keep the differential gain flat so the quality factor is from 0.7 to 1. The resonance frequency must be at least twice the desired bandwidth.

The chosen components give a quality factor of 0.89 and a resonance frequency of 53 KHz.

The overall transfer function is shown in Equation 6:

$$\frac{v_o}{i_{outL+} - i_{outL-}} = \frac{R}{1 + RCS} \times \frac{R3}{R1} \times \frac{1}{1 + \frac{R2R3}{R1/|R2|/R3} C2S + 2R2R3C1C2S^2} \tag{6}$$

The DC gain = $\frac{RR3}{R1}$ and is 398 mV/mA.

The poles are at 53 KHz and 80 KHz.

9.2.3 Application Curves

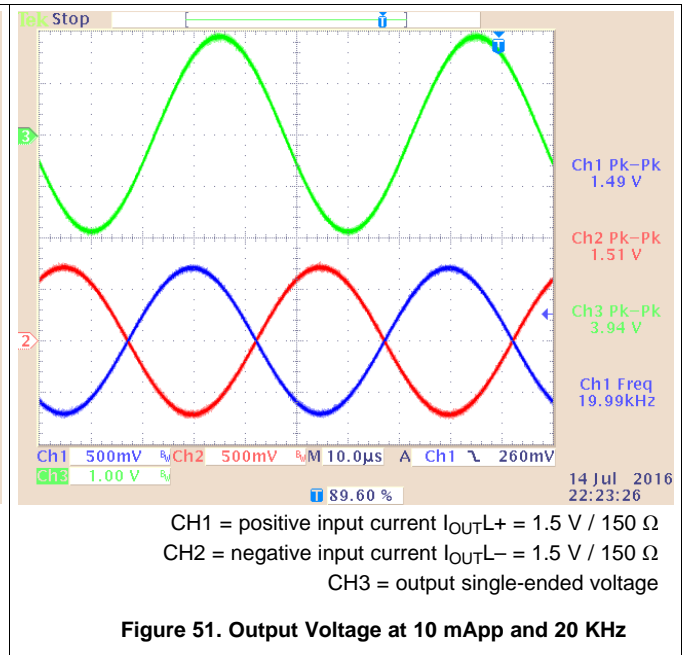
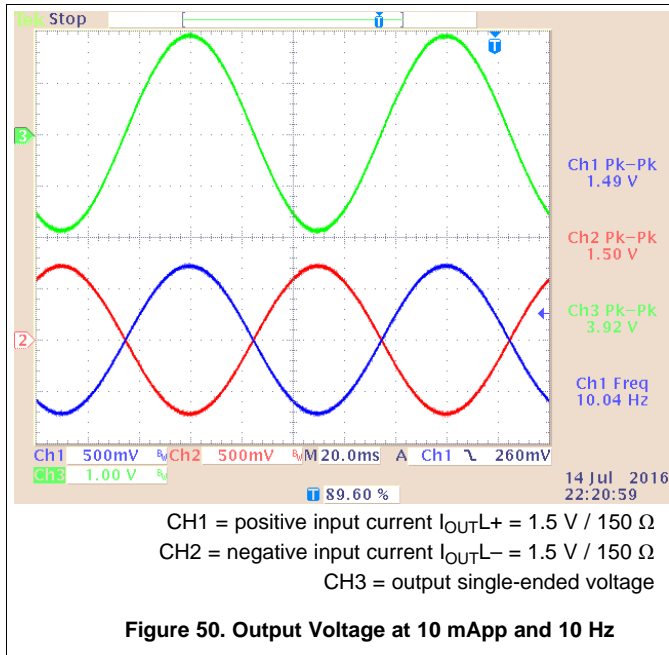

10 Power Supply Recommendations

The OPA1662-Q1 is specified for operation from 3 V to 36 V ($\pm 1.5 \text{ V}$ to 18 V) and at an ambient operating temperature from -40°C to 85°C . Parameters that can exhibit significant variance with regard to operating voltage or temperature are presented in [Typical Characteristics](#).

11 Layout

11.1 Layout Guidelines

The OPA1662-Q1 is a unity-gain stable, precision dual op amp with very low noise. To realize the full operational performance of the device, good high-frequency printed-circuit board (PCB) layout practices are required. Low-loss, 0.1- μF bypass capacitors must be connected between each supply pin and ground as close to the device as possible. The bypass capacitor traces must be designed for minimum inductance.

11.2 Layout Example

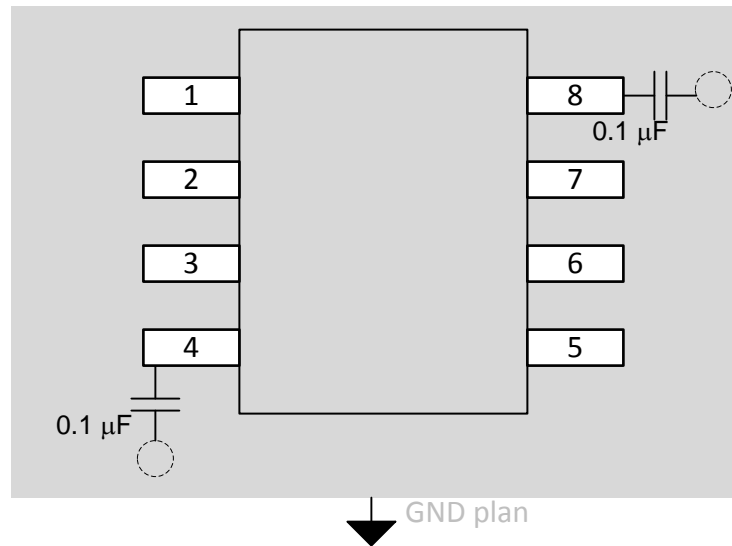

Figure 52. Layout Recommendation

11.3 Power Dissipation

The OPA1662-Q1 op amp is capable of driving 2-k Ω loads with a power-supply voltage up to ± 18 V and full operating temperature range. Internal power dissipation increases when operating at high supply voltages. Copper leadframe construction used in the OPA1662-Q1 op amp improves heat dissipation compared to conventional materials. Circuit board layout can also help minimize junction temperature rise. Wide copper traces help dissipate the heat by acting as an additional heat sink. Temperature rise can be further minimized by soldering the devices to the circuit board rather than using a socket.

12 Device and Documentation Support

12.1 Documentation Support

12.1.1 Related Documentation

For related documentation see the following:

- [Applications Bulletin: Feedback Plots Define Op Amp AC Performance](#) (SBOA015)
- [A High-Power High-Fidelity Headphone Amplifier for Current Output Audio DACs Reference Design](#) (TIDU672)

12.2 Receiving Notification of Documentation Updates

To receive notification of documentation updates, navigate to the device product folder on ti.com. In the upper right corner, click on *Alert me* to register and receive a weekly digest of any product information that has changed. For change details, review the revision history included in any revised document.

12.3 Community Resources

The following links connect to TI community resources. Linked contents are provided "AS IS" by the respective contributors. They do not constitute TI specifications and do not necessarily reflect TI's views; see TI's [Terms of Use](#).

TI E2E™ Online Community *TI's Engineer-to-Engineer (E2E) Community*. Created to foster collaboration among engineers. At e2e.ti.com, you can ask questions, share knowledge, explore ideas and help solve problems with fellow engineers.

Design Support *TI's Design Support* Quickly find helpful E2E forums along with design support tools and contact information for technical support.

12.4 Trademarks

E2E is a trademark of Texas Instruments.
All other trademarks are the property of their respective owners.

12.5 Electrostatic Discharge Caution



This integrated circuit can be damaged by ESD. Texas Instruments recommends that all integrated circuits be handled with appropriate precautions. Failure to observe proper handling and installation procedures can cause damage.

ESD damage can range from subtle performance degradation to complete device failure. Precision integrated circuits may be more susceptible to damage because very small parametric changes could cause the device not to meet its published specifications.

12.6 Glossary

[SLYZ022](#) — *TI Glossary*.

This glossary lists and explains terms, acronyms, and definitions.

13 Mechanical, Packaging, and Orderable Information

The following pages include mechanical, packaging, and orderable information. This information is the most current data available for the designated devices. This data is subject to change without notice and revision of this document. For browser-based versions of this data sheet, refer to the left-hand navigation.

PACKAGING INFORMATION

Orderable Device	Status (1)	Package Type	Package Drawing	Pins	Package Qty	Eco Plan (2)	Lead finish/ Ball material (6)	MSL Peak Temp (3)	Op Temp (°C)	Device Marking (4/5)	Samples
OPA1662AIDGKRQ1	ACTIVE	VSSOP	DGK	8	2500	RoHS & Green	NIPDAUAG	Level-2-260C-1 YEAR	-40 to 85	OUUI	Samples
OPA1662AIDRQ1	ACTIVE	SOIC	D	8	2500	RoHS & Green	NIPDAU	Level-2-260C-1 YEAR	-40 to 85	O1662Q	Samples

(1) The marketing status values are defined as follows:

ACTIVE: Product device recommended for new designs.

LIFEBUY: TI has announced that the device will be discontinued, and a lifetime-buy period is in effect.

NRND: Not recommended for new designs. Device is in production to support existing customers, but TI does not recommend using this part in a new design.

PREVIEW: Device has been announced but is not in production. Samples may or may not be available.

OBSELETE: TI has discontinued the production of the device.

(2) **RoHS:** TI defines "RoHS" to mean semiconductor products that are compliant with the current EU RoHS requirements for all 10 RoHS substances, including the requirement that RoHS substance do not exceed 0.1% by weight in homogeneous materials. Where designed to be soldered at high temperatures, "RoHS" products are suitable for use in specified lead-free processes. TI may reference these types of products as "Pb-Free".

RoHS Exempt: TI defines "RoHS Exempt" to mean products that contain lead but are compliant with EU RoHS pursuant to a specific EU RoHS exemption.

Green: TI defines "Green" to mean the content of Chlorine (Cl) and Bromine (Br) based flame retardants meet JS709B low halogen requirements of <=1000ppm threshold. Antimony trioxide based flame retardants must also meet the <=1000ppm threshold requirement.

(3) MSL, Peak Temp. - The Moisture Sensitivity Level rating according to the JEDEC industry standard classifications, and peak solder temperature.

(4) There may be additional marking, which relates to the logo, the lot trace code information, or the environmental category on the device.

(5) Multiple Device Markings will be inside parentheses. Only one Device Marking contained in parentheses and separated by a "~" will appear on a device. If a line is indented then it is a continuation of the previous line and the two combined represent the entire Device Marking for that device.

(6) Lead finish/Ball material - Orderable Devices may have multiple material finish options. Finish options are separated by a vertical ruled line. Lead finish/Ball material values may wrap to two lines if the finish value exceeds the maximum column width.

Important Information and Disclaimer:The information provided on this page represents TI's knowledge and belief as of the date that it is provided. TI bases its knowledge and belief on information provided by third parties, and makes no representation or warranty as to the accuracy of such information. Efforts are underway to better integrate information from third parties. TI has taken and continues to take reasonable steps to provide representative and accurate information but may not have conducted destructive testing or chemical analysis on incoming materials and chemicals. TI and TI suppliers consider certain information to be proprietary, and thus CAS numbers and other limited information may not be available for release.

In no event shall TI's liability arising out of such information exceed the total purchase price of the TI part(s) at issue in this document sold by TI to Customer on an annual basis.

OTHER QUALIFIED VERSIONS OF OPA1662-Q1 :

- Catalog: [OPA1662](#)

NOTE: Qualified Version Definitions:

- Catalog - TI's standard catalog product

TAPE AND REEL INFORMATION

QUADRANT ASSIGNMENTS FOR PIN 1 ORIENTATION IN TAPE

*All dimensions are nominal

Device	Package Type	Package Drawing	Pins	SPQ	Reel Diameter (mm)	Reel Width W1 (mm)	A0 (mm)	B0 (mm)	K0 (mm)	P1 (mm)	W (mm)	Pin1 Quadrant
OPA1662AIDGKRQ1	VSSOP	DGK	8	2500	330.0	12.4	5.3	3.4	1.4	8.0	12.0	Q1
OPA1662AIDRQ1	SOIC	D	8	2500	330.0	12.4	6.4	5.2	2.1	8.0	12.0	Q1

TAPE AND REEL BOX DIMENSIONS

*All dimensions are nominal

Device	Package Type	Package Drawing	Pins	SPQ	Length (mm)	Width (mm)	Height (mm)
OPA1662AIDGKRQ1	VSSOP	DGK	8	2500	366.0	364.0	50.0
OPA1662AIDRQ1	SOIC	D	8	2500	853.0	449.0	35.0



D0008A

PACKAGE OUTLINE

SOIC - 1.75 mm max height

SMALL OUTLINE INTEGRATED CIRCUIT



NOTES:

1. Linear dimensions are in inches [millimeters]. Dimensions in parenthesis are for reference only. Controlling dimensions are in inches. Dimensioning and tolerancing per ASME Y14.5M.
2. This drawing is subject to change without notice.
3. This dimension does not include mold flash, protrusions, or gate burrs. Mold flash, protrusions, or gate burrs shall not exceed $.006$ [0.15] per side.
4. This dimension does not include interlead flash.
5. Reference JEDEC registration MS-012, variation AA.

EXAMPLE BOARD LAYOUT

D0008A

SOIC - 1.75 mm max height

SMALL OUTLINE INTEGRATED CIRCUIT



LAND PATTERN EXAMPLE
 EXPOSED METAL SHOWN
 SCALE:8X



SOLDER MASK DETAILS

4214825/C 02/2019

NOTES: (continued)

- 6. Publication IPC-7351 may have alternate designs.
- 7. Solder mask tolerances between and around signal pads can vary based on board fabrication site.

EXAMPLE STENCIL DESIGN

D0008A

SOIC - 1.75 mm max height

SMALL OUTLINE INTEGRATED CIRCUIT



SOLDER PASTE EXAMPLE
BASED ON .005 INCH [0.125 MM] THICK STENCIL
SCALE:8X

4214825/C 02/2019

NOTES: (continued)

8. Laser cutting apertures with trapezoidal walls and rounded corners may offer better paste release. IPC-7525 may have alternate design recommendations.
9. Board assembly site may have different recommendations for stencil design.

DGK (S-PDSO-G8)

PLASTIC SMALL-OUTLINE PACKAGE



- NOTES:
- A. All linear dimensions are in millimeters.
 - B. This drawing is subject to change without notice.
 - C. Body length does not include mold flash, protrusions, or gate burrs. Mold flash, protrusions, or gate burrs shall not exceed 0.15 per end.
 - D. Body width does not include interlead flash. Interlead flash shall not exceed 0.50 per side.
 - E. Falls within JEDEC MO-187 variation AA, except interlead flash.

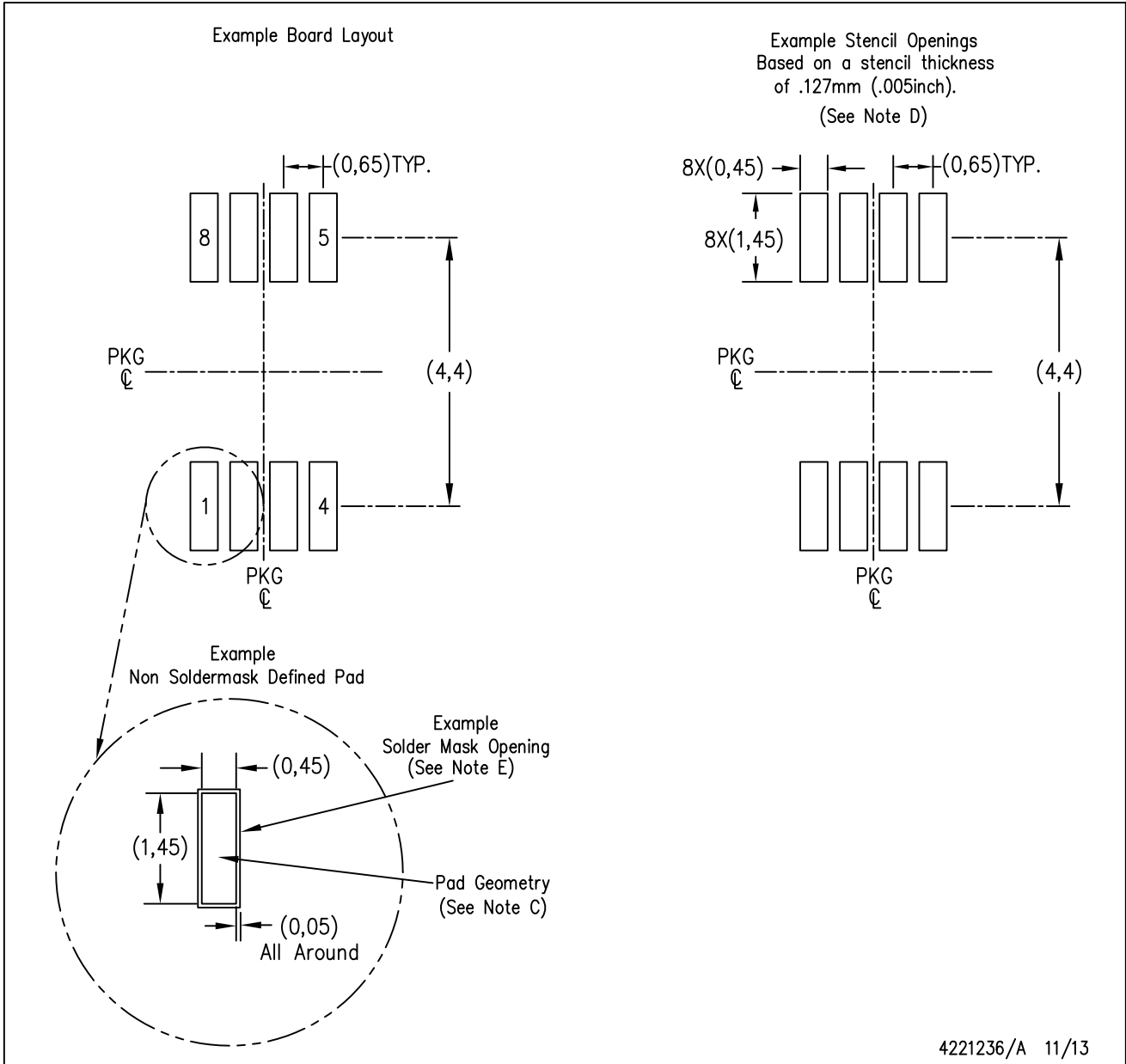

- NOTES:
- A. All linear dimensions are in millimeters.
 - B. This drawing is subject to change without notice.
 - C. Publication IPC-7351 is recommended for alternate designs.
 - D. Laser cutting apertures with trapezoidal walls and also rounding corners will offer better paste release. Customers should contact their board assembly site for stencil design recommendations. Refer to IPC-7525 for other stencil recommendations.
 - E. Customers should contact their board fabrication site for solder mask tolerances between and around signal pads.

IMPORTANT NOTICE AND DISCLAIMER

TI PROVIDES TECHNICAL AND RELIABILITY DATA (INCLUDING DATASHEETS), DESIGN RESOURCES (INCLUDING REFERENCE DESIGNS), APPLICATION OR OTHER DESIGN ADVICE, WEB TOOLS, SAFETY INFORMATION, AND OTHER RESOURCES "AS IS" AND WITH ALL FAULTS, AND DISCLAIMS ALL WARRANTIES, EXPRESS AND IMPLIED, INCLUDING WITHOUT LIMITATION ANY IMPLIED WARRANTIES OF MERCHANTABILITY, FITNESS FOR A PARTICULAR PURPOSE OR NON-INFRINGEMENT OF THIRD PARTY INTELLECTUAL PROPERTY RIGHTS.

These resources are intended for skilled developers designing with TI products. You are solely responsible for (1) selecting the appropriate TI products for your application, (2) designing, validating and testing your application, and (3) ensuring your application meets applicable standards, and any other safety, security, or other requirements. These resources are subject to change without notice. TI grants you permission to use these resources only for development of an application that uses the TI products described in the resource. Other reproduction and display of these resources is prohibited. No license is granted to any other TI intellectual property right or to any third party intellectual property right. TI disclaims responsibility for, and you will fully indemnify TI and its representatives against, any claims, damages, costs, losses, and liabilities arising out of your use of these resources.

TI's products are provided subject to TI's Terms of Sale (www.ti.com/legal/termsofsale.html) or other applicable terms available either on ti.com or provided in conjunction with such TI products. TI's provision of these resources does not expand or otherwise alter TI's applicable warranties or warranty disclaimers for TI products.

Mailing Address: Texas Instruments, Post Office Box 655303, Dallas, Texas 75265
Copyright © 2020, Texas Instruments Incorporated