

## Features

- $BV_{CEO} > -30V$
- $I_C = -5.5A$  High Continuous Collector Current
- $I_C = -20A$  Peak Pulse Current
- Low Saturation Voltage  $V_{CE(SAT)} < -140mV @ -1A$
- $h_{FE}$  Specified up to  $-20A$  for a High Gain Hold-Up
- **Lead-Free Finish; RoHS Compliant (Notes 1 & 2)**
- **Halogen and Antimony Free. "Green" Device (Note 3)**
- **Qualified to AEC-Q101 Standards for High Reliability**
- **PPAP Capable (Note 4)**

## Mechanical Data

- Case: SOT223
- Case Material: Molded Plastic. "Green" Molding Compound. UL Flammability Rating 94V-0
- Moisture Sensitivity: Level 1 per J-STD-020
- Terminals: Finish - Matte Tin Plated Leads; Solderable per MIL-STD-202, Method 208
- Weight: 0.112 grams (Approximate)

SOT223



Top View

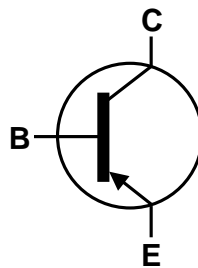

Device Symbol

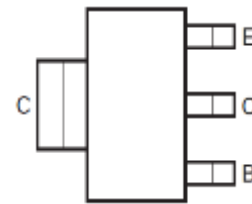
 Top View  
Pin-Out

## Ordering Information (Notes 4 & 5)

Product	Compliance	Marking	Reel Size (inches)	Tape Width (mm)	Quantity per Reel
FZT949TA	AEC-Q101	FZT949	7	12	1,000
FZT949QTA	Automotive	FZT949	7	12	1,000

- Notes:
1. EU Directive 2002/95/EC (RoHS) & 2011/65/EU (RoHS 2) compliant. All applicable RoHS exemptions applied.
  2. See <https://www.diodes.com/quality/lead-free/> for more information about Diodes Incorporated's definitions of Halogen- and Antimony-free, "Green" and Lead-free.
  3. Halogen- and Antimony-free "Green" products are defined as those which contain <900ppm bromine, <900ppm chlorine (<1500ppm total Br + Cl) and <1000ppm antimony compounds.
  4. Automotive products are AEC-Q101 qualified and are PPAP capable. Automotive, AEC-Q101 and standard products are electrically and thermally the same, except where specified.
  5. For packaging details, go to our website at <https://www.diodes.com/design/support/packaging/diodes-packaging/>.

## Marking Information

SOT223

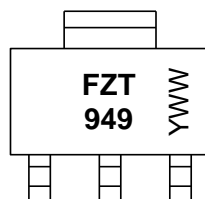

FZT 949 = Product Type Marking Code  
 YWW = Date Code Marking  
 Y or  $\bar{Y}$  = Last Digit of Year (ex: 7 = 2017)  
 WW or  $\bar{W}W$  = Week Code (01-53)

**Absolute Maximum Ratings** (@T<sub>A</sub> = +25°C, unless otherwise specified.)

Characteristic	Symbol	Value	Unit
Collector-Base Voltage	V <sub>CBO</sub>	-50	V
Collector-Emitter Voltage	V <sub>CEO</sub>	-30	V
Emitter-Base Voltage	V <sub>EBO</sub>	-7	V
Continuous Collector Current	I <sub>C</sub>	-5.5	A
Peak Pulse Current	I <sub>CM</sub>	-20	A

**Thermal Characteristics** (@T<sub>A</sub> = +25°C, unless otherwise specified.)

Characteristic	Symbol	Value	Unit
Power Dissipation Linear Derating Factor	P <sub>D</sub>	3.0	W
		24	
		1.6	mW/°C
		12.8	
Thermal Resistance, Junction to Ambient	R <sub>θJA</sub>	42	°C/W
	R <sub>θJA</sub>	78	
Thermal Resistance Junction to Lead	R <sub>θJL</sub>	8.8	
Operating and Storage Temperature Range	T <sub>J</sub> , T <sub>STG</sub>	-55 to +150	°C

**ESD Ratings** (Note 9)

Characteristic	Symbol	Value	Unit	JEDEC Class
Electrostatic Discharge - Human Body Model	ESD HBM	4,000	V	3A
Electrostatic Discharge - Machine Model	ESD MM	400	V	C

- Notes:
6. For a device mounted with the collector lead on 52mm x 52mm 2oz copper that is on a single sided 1.6mm FR4 PCB; device is measured under still air conditions whilst operating in a steady-state.
  7. Same as Note 6, except mounted on 25mm x 25mm 1oz copper.
  8. Thermal resistance from junction to solder-point (at the end of the collector lead).
  9. Refer to JEDEC specification JESD22-A114 and JESD22-A115.

**Thermal Characteristics and Derating Information**

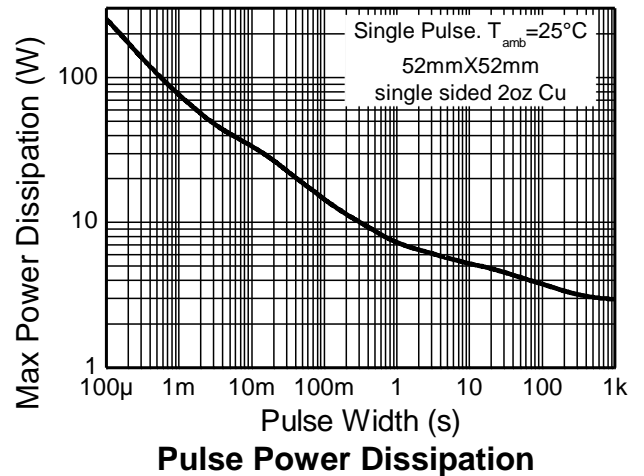
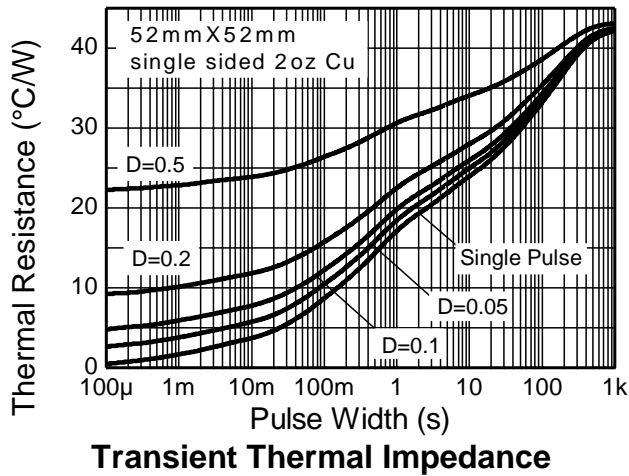
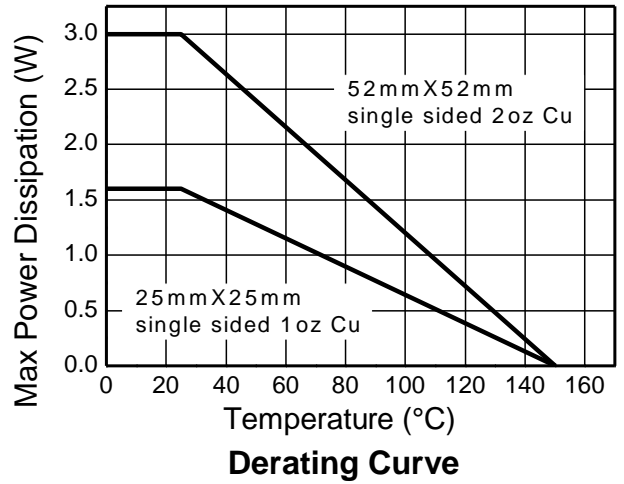
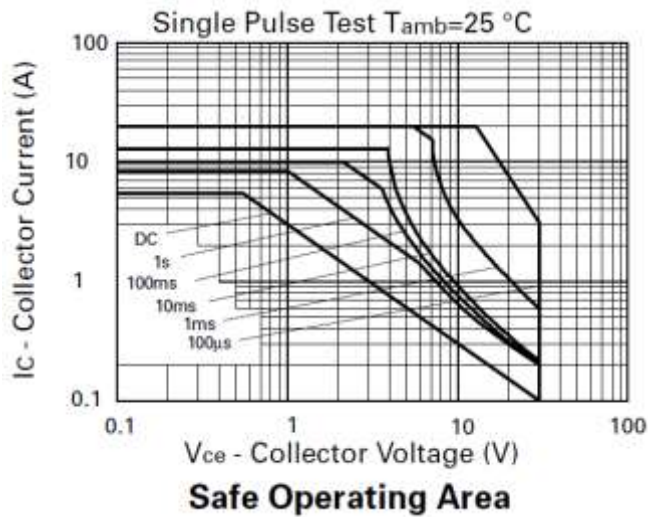

**Electrical Characteristics** (@ $T_A = +25^\circ\text{C}$ , unless otherwise specified.)

Characteristic	Symbol	Min	Typ.	Max	Unit	Test Condition
Collector-Base Breakdown Voltage	$BV_{CBO}$	-50	-80	—	V	$I_C = -100\mu\text{A}$
Collector-Emitter Breakdown Voltage (Note 10)	$BV_{CER}$	-50	-80	—	V	$I_C = -1\mu\text{A}$ , $R_B \leq 1\text{k}\Omega$
Collector-Emitter Breakdown Voltage (Note 10)	$BV_{CEO}$	-30	-45	—	V	$I_C = -10\text{mA}$
Emitter-Base Breakdown Voltage	$BV_{EBO}$	-7	-8	—	V	$I_E = -100\mu\text{A}$
Collector Cut-Off Current	$I_{CBO}$	—	—	-50 -1	nA $\mu\text{A}$	$V_{CB} = -40\text{V}$ $V_{CB} = -40\text{V}$ , $T_A = +100^\circ\text{C}$
Collector Cut-Off Current	$I_{CER}$	—	—	-50 -1	nA $\mu\text{A}$	$V_{CE} = -40\text{V}$ , $R \leq 1\text{k}\Omega$ $V_{CE} = -40\text{V}$ , $T_A = +100^\circ\text{C}$
Emitter Cut-Off Current	$I_{EBO}$	—	—	-10	nA	$V_{EB} = -6\text{V}$
DC Current Transfer Static Ratio (Note 10)	$h_{FE}$	100	200	—	—	$I_C = -10\text{mA}$ , $V_{CE} = -1\text{V}$
		100	200	300		$I_C = -1\text{A}$ , $V_{CE} = -1\text{V}$
		75	140	—		$I_C = -5\text{A}$ , $V_{CE} = -1\text{V}$
		—	35	—		$I_C = -20\text{A}$ , $V_{CE} = -2\text{V}$
Collector-Emitter Saturation Voltage (Note 10)	$V_{CE(SAT)}$	—	-50	-75	mV	$I_C = -500\text{mA}$ , $I_B = -20\text{mA}$
		—	-85	-140		$I_C = -1\text{A}$ , $I_B = -20\text{mA}$
		—	-190	-270		$I_C = -2\text{A}$ , $I_B = -200\text{mA}$
		—	-350	-440		$I_C = -5.5\text{A}$ , $I_B = -500\text{mA}$
Base-Emitter Saturation Voltage (Note 10)	$V_{BE(SAT)}$	—	-1,100	-1,250	mV	$I_C = -5.5\text{A}$ , $I_B = -500\text{mA}$
Base-Emitter Turn-On Voltage (Note 10)	$V_{BE(ON)}$	—	-900	-1,060	mV	$I_C = -5.5\text{A}$ , $V_{CE} = -1\text{V}$
Transitional Frequency (Note 10)	$f_T$	—	100	—	MHz	$I_C = -100\text{mA}$ , $V_{CE} = -10\text{V}$ , $f = 50\text{MHz}$
Output Capacitance	$C_{OBO}$	—	122	—	pF	$V_{CB} = -10\text{V}$ , $f = 1\text{MHz}$
Switching Time	$t_{ON}$	—	120	—	ns	$V_{CC} = -10\text{V}$ , $I_C = -4\text{A}$ , $I_{B1} = -I_{B2} = -400\text{mA}$
	$t_{OFF}$	—	130	—		

Note: 10. Measured under pulsed conditions. Pulse width  $\leq 300\mu\text{s}$ . Duty cycle  $\leq 2\%$ .

**Typical Electrical Characteristics** (@T<sub>A</sub> = +25°C, unless otherwise specified.)

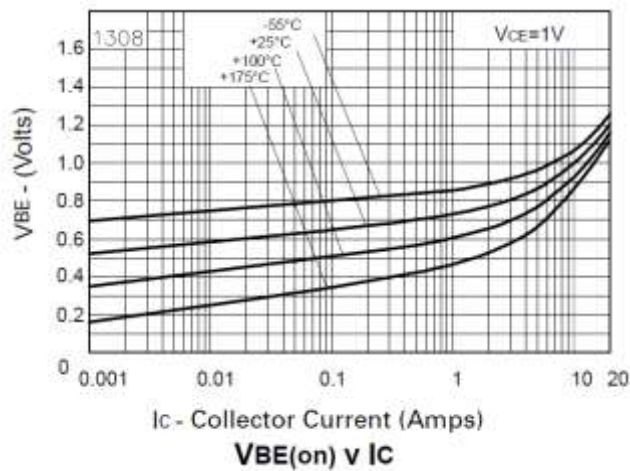
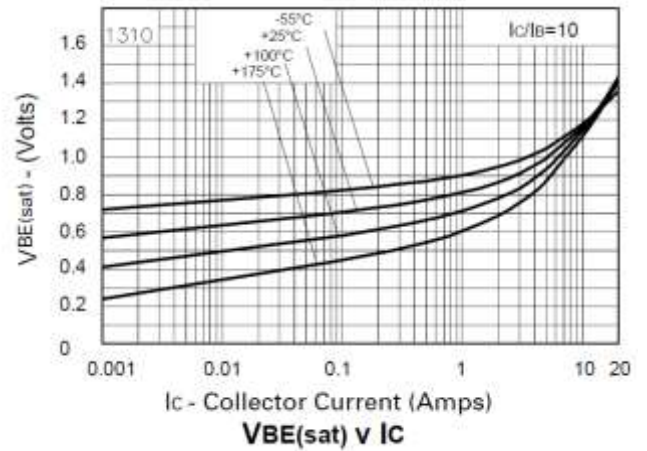
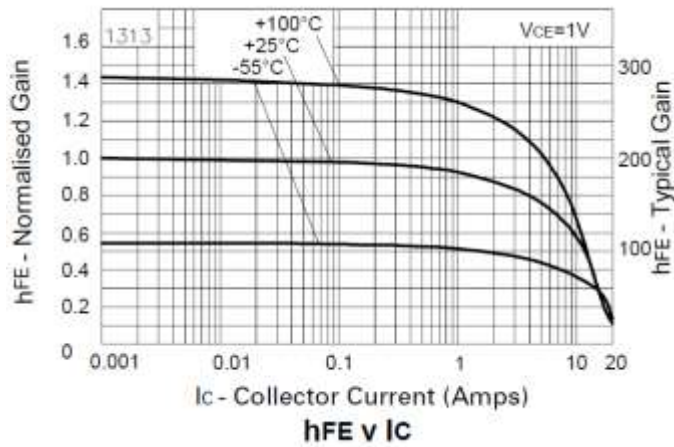
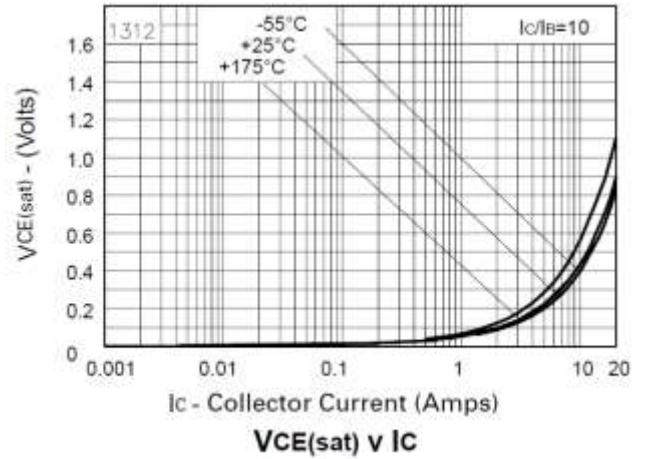
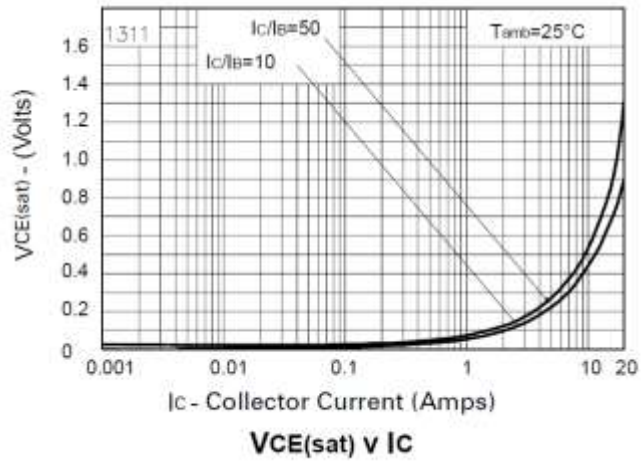

## Package Outline Dimensions

Please see <http://www.diodes.com/package-outlines.html> for the latest version.

SOT223

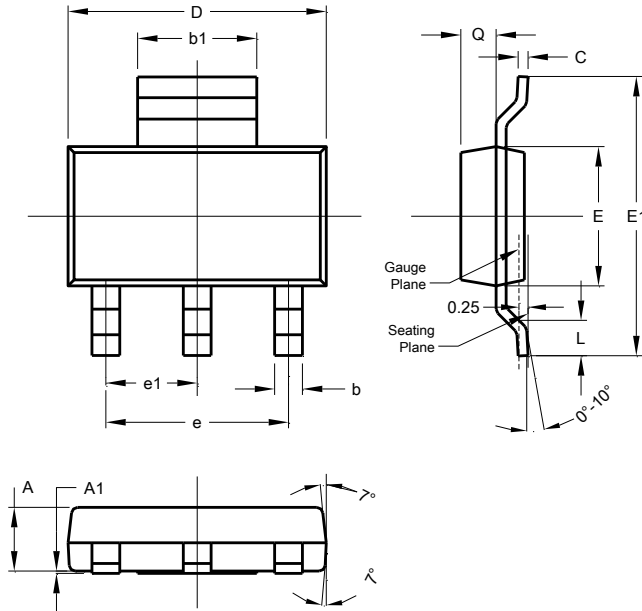

SOT223			
Dim	Min	Max	Typ
A	1.55	1.65	1.60
A1	0.010	0.15	0.05
b	0.60	0.80	0.70
b1	2.90	3.10	3.00
C	0.20	0.30	0.25
D	6.45	6.55	6.50
E	3.45	3.55	3.50
E1	6.90	7.10	7.00
e	-	-	4.60
e1	-	-	2.30
L	0.85	1.05	0.95
Q	0.84	0.94	0.89
All Dimensions in mm			

## Suggested Pad Layout

Please see <http://www.diodes.com/package-outlines.html> for the latest version.

SOT223

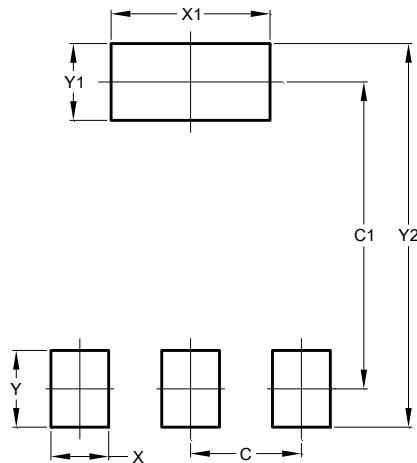

Dimensions	Value (in mm)
C	2.30
C1	6.40
X	1.20
X1	3.30
Y	1.60
Y1	1.60
Y2	8.00

**IMPORTANT NOTICE**

DIODES INCORPORATED MAKES NO WARRANTY OF ANY KIND, EXPRESS OR IMPLIED, WITH REGARDS TO THIS DOCUMENT, INCLUDING, BUT NOT LIMITED TO, THE IMPLIED WARRANTIES OF MERCHANTABILITY AND FITNESS FOR A PARTICULAR PURPOSE (AND THEIR EQUIVALENTS UNDER THE LAWS OF ANY JURISDICTION).

Diodes Incorporated and its subsidiaries reserve the right to make modifications, enhancements, improvements, corrections or other changes without further notice to this document and any product described herein. Diodes Incorporated does not assume any liability arising out of the application or use of this document or any product described herein; neither does Diodes Incorporated convey any license under its patent or trademark rights, nor the rights of others. Any Customer or user of this document or products described herein in such applications shall assume all risks of such use and will agree to hold Diodes Incorporated and all the companies whose products are represented on Diodes Incorporated website, harmless against all damages.

Diodes Incorporated does not warrant or accept any liability whatsoever in respect of any products purchased through unauthorized sales channel. Should Customers purchase or use Diodes Incorporated products for any unintended or unauthorized application, Customers shall indemnify and hold Diodes Incorporated and its representatives harmless against all claims, damages, expenses, and attorney fees arising out of, directly or indirectly, any claim of personal injury or death associated with such unintended or unauthorized application.

Products described herein may be covered by one or more United States, international or foreign patents pending. Product names and markings noted herein may also be covered by one or more United States, international or foreign trademarks.

This document is written in English but may be translated into multiple languages for reference. Only the English version of this document is the final and determinative format released by Diodes Incorporated.

**LIFE SUPPORT**

Diodes Incorporated products are specifically not authorized for use as critical components in life support devices or systems without the express written approval of the Chief Executive Officer of Diodes Incorporated. As used herein:

A. Life support devices or systems are devices or systems which:

1. are intended to implant into the body, or
2. support or sustain life and whose failure to perform when properly used in accordance with instructions for use provided in the labeling can be reasonably expected to result in significant injury to the user.

B. A critical component is any component in a life support device or system whose failure to perform can be reasonably expected to cause the failure of the life support device or to affect its safety or effectiveness.

Customers represent that they have all necessary expertise in the safety and regulatory ramifications of their life support devices or systems, and acknowledge and agree that they are solely responsible for all legal, regulatory and safety-related requirements concerning their products and any use of Diodes Incorporated products in such safety-critical, life support devices or systems, notwithstanding any devices- or systems-related information or support that may be provided by Diodes Incorporated. Further, Customers must fully indemnify Diodes Incorporated and its representatives against any damages arising out of the use of Diodes Incorporated products in such safety-critical, life support devices or systems.

Copyright © 2017, Diodes Incorporated

[www.diodes.com](http://www.diodes.com)

# Mouser Electronics

Authorized Distributor

Click to View Pricing, Inventory, Delivery & Lifecycle Information:

[Diodes Incorporated:](#)

[FZT949TA](#) [FZT949QTA](#)