

Date	SYM	REVISION RECORD	AUTH	DR.	CK.
12/11/15	E	CHANGED MICRO-SEC TO MILLISECONDS	T.B.	B.S.	
10/31/19	F	ADDED WEIGHT OF THE PART	T.B.	B.S.	

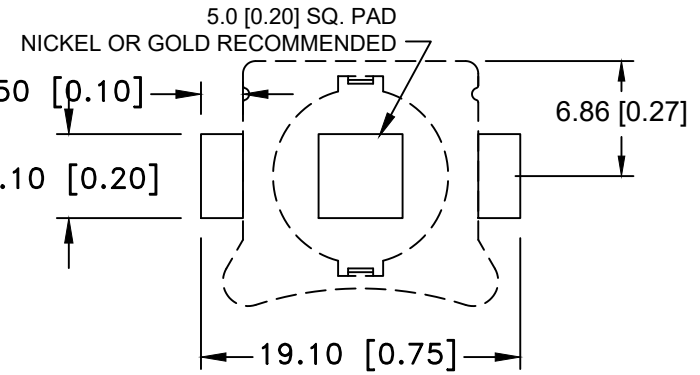

PCB LAYOUT

INSULATOR

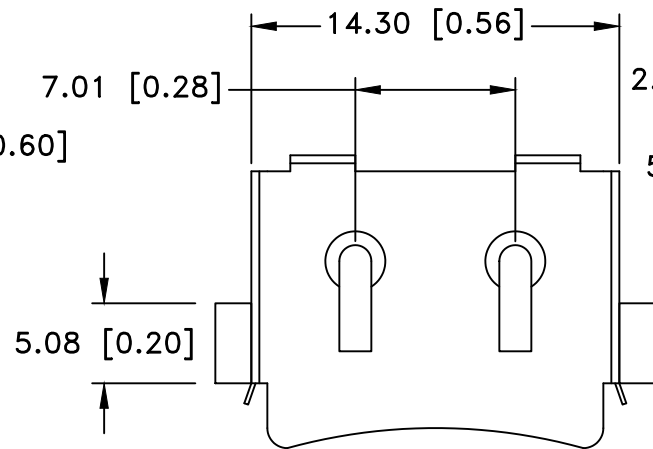
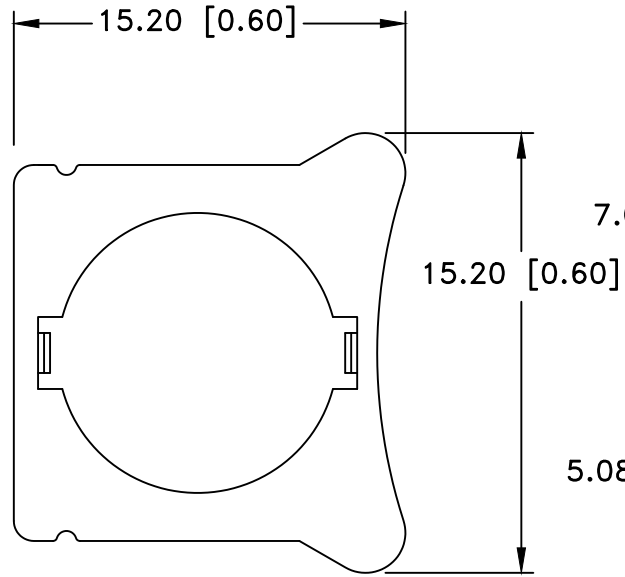
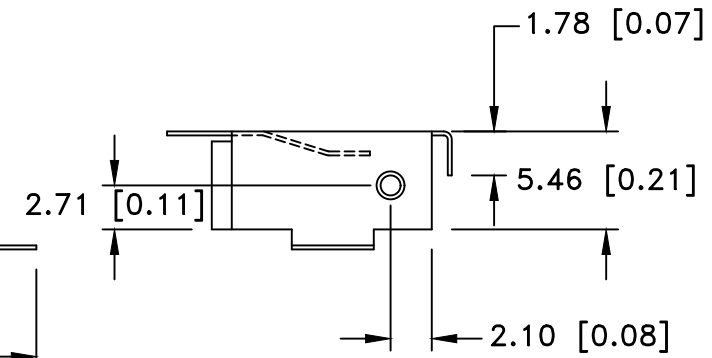
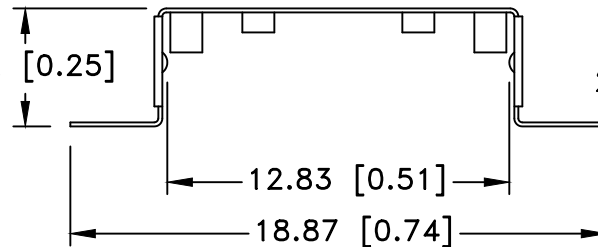
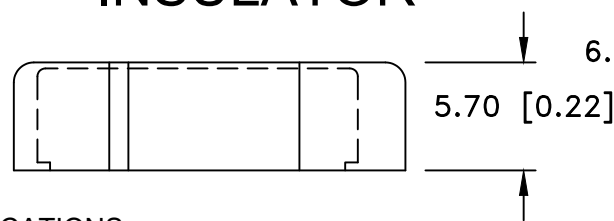

SPECIFICATIONS:

- * Holder material- Polypropylene, AV161 PP, Off White
- * UL Flammability Rating: UL 94-HB File No. E108370
- * Contacts : Phosphor Bronze C5191, Nickel Plated 80-150u thickness
- * Vibration test: 10-50-10 hz swept in 60 seconds
x,y,z direction: 1 hour each direction
- * Result: no dislodgement of the cell or damage
no discontinuity over 10 milliseconds
- * Shock test: half sine wave acceleration 150g.
6 milliseconds 3 shock pulses each direction per axis,
total of 18 pulses
- * Result: no evidence of physical damage
- * Approximate weight: Retainer - 0.74g, Insulator - 0.30g
- * ROHS COMPLIANT

Tolerance (Except as noted)	 Memory Protection Devices, Inc 200 Broad Hollow Road, Farmingdale, New York 11735		
	decimal ±.5 (.020)	Scale	Drawn By B.S. Approved By T.B.
Fractional ± .8 (.030)	Title LR44 BATTERY RETAINER WITH INSULATOR		
Angular ± 3°	Date 10/31/19	Drawing Number BHX1-LR44-SM	