

Features

- Nominal Zener Voltages: 5.6V, 6.8V, 10V, 18V
- Ultra-Small Surface Mount Package
- Ideal For Transient Suppression
- **Lead Free/RoHS Compliant (Note 4)**
- **"Green" Device (Note 5 and 6)**

ESD Sensitivity Rating

- AEC-Q101, HBM - 8kV, MM - 400V (AZ23C5V6W - AZ23C18W)
- IEC 61000-4-2, Air - Exceeds 25kV, Contact - 8kV (AZ23C5V6W, AZ23C6V8W)
- IEC 61000-4-2, Air - Exceeds 15kV, Contact - 8kV (AZ23C10W, AZ23C18W)



Top View

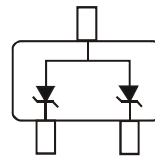

Device Schematic

Mechanical Data

- Case: SOT-323
- Case Material: Molded Plastic, "Green" Molding Compound, Note 6. UL Flammability Classification Rating 94V-0
- Moisture Sensitivity: Level 1 per J-STD-020D
- Terminals: Solderable per MIL-STD-202, Method 208
- Terminal Connections: See Diagram
- Lead Free Plating (Matte Tin Finish annealed over Alloy 42 leadframe).
- Marking Information: See Table Below & Page 2
- Ordering Information: See Page 2
- Weight: 0.006 grams (approximate)

Maximum Ratings @ $T_A = 25^\circ\text{C}$ unless otherwise specified

Single phase, half wave, 60Hz, resistive or inductive load.
For capacitance load, derate current by 20%.

Characteristic	Symbol	Value	Unit
Forward Voltage @ $I_F = 10\text{mA}$	V_F	0.9	V

Thermal Characteristics

Characteristic	Symbol	Value	Unit
Power Dissipation (Note 1)	P_D	200	mW
Thermal Resistance, Junction to Ambient Air (Note 1)	$R_{\theta JA}$	625	$^\circ\text{C/W}$
Operating and Storage Temperature Range	T_J, T_{STG}	-65 to +150	$^\circ\text{C}$

Electrical Characteristics @ $T_A = 25^\circ\text{C}$ unless otherwise specified

Type Number	Marking Code	Zener Voltage Range (Note 2)			Maximum Zener Impedance (Note 3)				Maximum Reverse Current (Note 2)		Temperature Coefficient of Zener Voltage @ $I_{ZT} = 5\text{mA}$	
		$V_Z @ I_{ZT}$			$Z_{ZT} @ I_{ZT}$		$Z_{ZK} @ I_{ZK}$		$I_R @ V_R$		$T_C (mV/^\circ\text{C})$	
		Nom (V)	Min (V)	Max (V)	Ω	mA	Ω	mA	μA	V	Min	Max
AZ23C5V6W	KD9	5.6	5.32	5.88	40	5.0	400	1.0	1.0	2.0	-2.0	2.5
AZ23C6V8W	KDB	6.8	6.47	7.14	15	5.0	80	1.0	2.0	4.0	1.2	4.5
AZ23C10W	KDF	10	9.4	10.6	15	5.0	70	1.0	0.2	7.0	4.5	8.0
AZ23C18W	KDL	18	16.8	19.1	50	5.0	170	1.0	0.1	12.6	12.4	16.0

- Notes:
1. Mounted on FR4 PC Board with recommended pad layout at <http://www.diodes.com/datasheets/ap02001.pdf>.
 2. Short duration pulse test used to minimize self-heating.
 3. $f = 1\text{KHz}$.
 4. No purposefully added lead.
 5. Diodes Inc.'s "Green" Policy can be found on our website at http://www.diodes.com/products/lead_free/index.php.
 6. Product manufactured with date code 0627 (week 27, 2006) and newer are built with Green Molding Compound. Product manufactured prior to date code 0627 are built with Non-Green Molding Compound and may contain Halogens or Sb2O3 Fire Retardants.

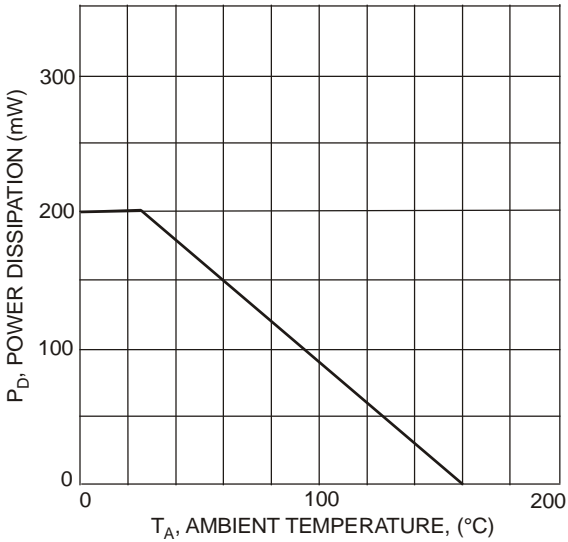

Fig. 1 Power Derating Curve

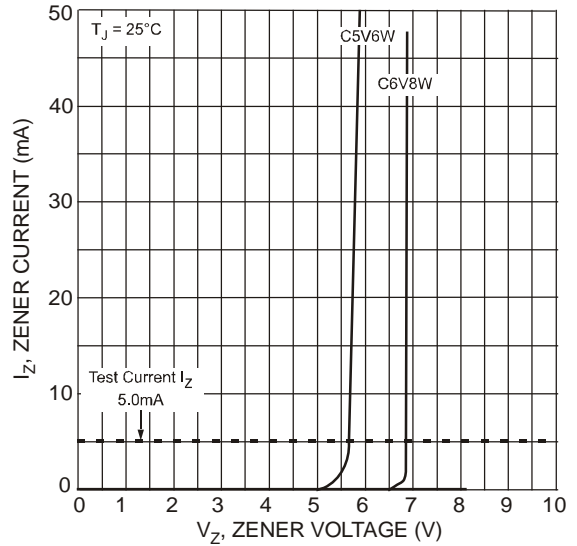

Fig. 2 Typical Zener Breakdown Characteristics

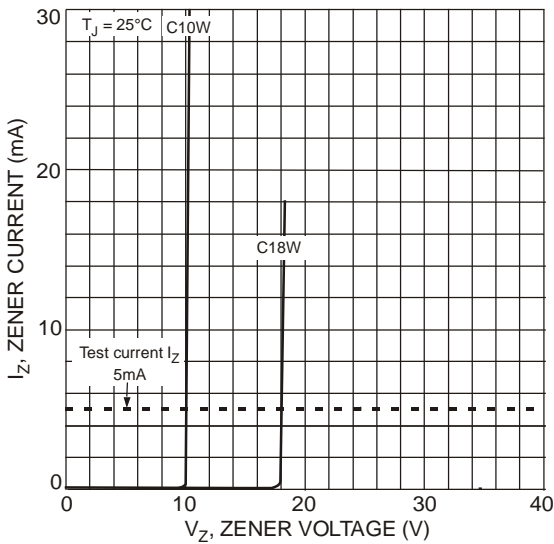

Fig. 3 Typical Zener Breakdown Characteristics

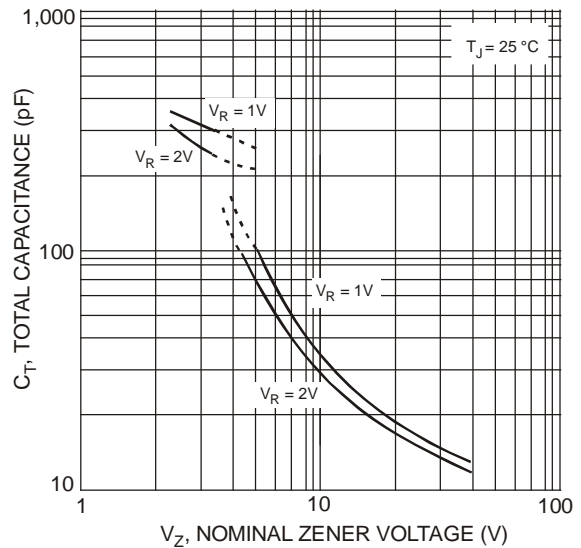

Fig. 4 Typical Total Capacitance vs. Nominal Zener Voltage

Ordering Information (Notes 6 & 7)

Part Number	Case	Packaging
(Type Number)-7-F*	SOT-323	3000/Tape & Reel

* Add "-7-F" to the appropriate type number in Electrical Characteristics Table from Page 1 example: 6.8V Zener = AZ23C6V8W-7-F.

Notes: 7. For packaging details, go to our website at <http://www.diodes.com/datasheets/ap02007.pdf>.

Marking Information

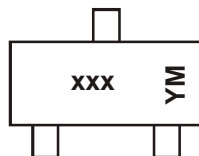

xxx = Product Type Marking Code
See Electrical Characteristics Table
YM = Date Code Marking
Y = Year (ex: N = 2002)
M = Month (ex: 9 = September)

Date Code Key

Year	1998	1999	2000	2001	2002	2003	2004	2005	2006	2007	2008	2009	2010	2111	2012
Code	J	K	L	M	N	P	R	S	T	U	V	W	X	Y	Z

Month	Jan	Feb	Mar	Apr	May	Jun	Jul	Aug	Sep	Oct	Nov	Dec
Code	1	2	3	4	5	6	7	8	9	O	N	D

Package Outline Dimensions

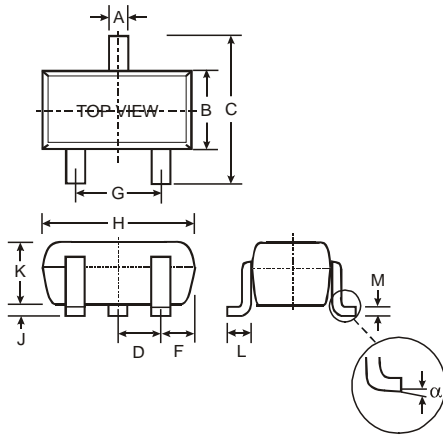

SOT-323		
Dim	Min	Max
A	0.25	0.40
B	1.15	1.35
C	2.00	2.20
D	0.65 Nominal	
F	0.30	0.40
G	1.20	1.40
H	1.80	2.20
J	0.0	0.10
K	0.90	1.00
L	0.25	0.40
M	0.10	0.18
α	0°	8°
All Dimensions in mm		

Suggested Pad Layout

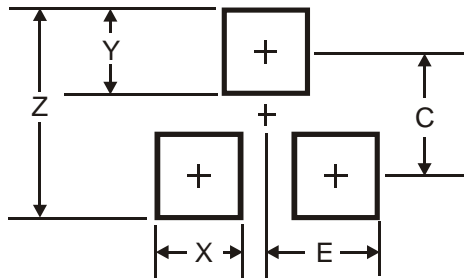

Dimensions	Value (in mm)
Z	2.8
X	0.7
Y	0.9
C	1.9
E	1.0

IMPORTANT NOTICE

Diodes Incorporated and its subsidiaries reserve the right to make modifications, enhancements, improvements, corrections or other changes without further notice to any product herein. Diodes Incorporated does not assume any liability arising out of the application or use of any product described herein; neither does it convey any license under its patent rights, nor the rights of others. The user of products in such applications shall assume all risks of such use and will agree to hold Diodes Incorporated and all the companies whose products are represented on our website, harmless against all damages.

LIFE SUPPORT

Diodes Incorporated products are not authorized for use as critical components in life support devices or systems without the expressed written approval of the President of Diodes Incorporated.