

CNY17F-1X, CNY17F-2X, CNY17F-3X, CNY17F-4X
 CNY17F-1, CNY17F-2, CNY17F-3, CNY17F-4



ISOCOM

COMPONENTS



NON-BASE LEAD OPTICALLY COUPLED ISOLATOR PHOTOTRANSISTOR OUTPUT

APPROVALS

- UL recognised, File No. E91231
Package Code GG
- 'X' SPECIFICATION APPROVALS
 - VDE 0884 in 3 available lead forms : -
 - STD
 - G form
 - SMD approved to CECC 00802
- Certified to EN60950 by
Nemko - Certificate No. P01102464

DESCRIPTION

The CNY17F-1, CNY17F-2, CNY17F-3, CNY17F-4 series of optically coupled isolators consist of infrared light emitting diode and NPN silicon photo transistor in a standard 6 pin dual in line plastic package with the base pin unconnected.

FEATURES

- Options :-
10mm lead spread - add G after part no.
Surface mount - add SM after part no.
Tape&reel - add SMT&R after part no.
- High BV_{CEO} (70V min)
- High Isolation Voltage ($5.3kV_{RMS} > 7.5kV_{PK}$)
- Base pin unconnected for improved noise immunity in high EMI environment

APPLICATIONS

- DC motor controllers
- Industrial systems controllers
- Signal transmission between systems of different potentials and impedances

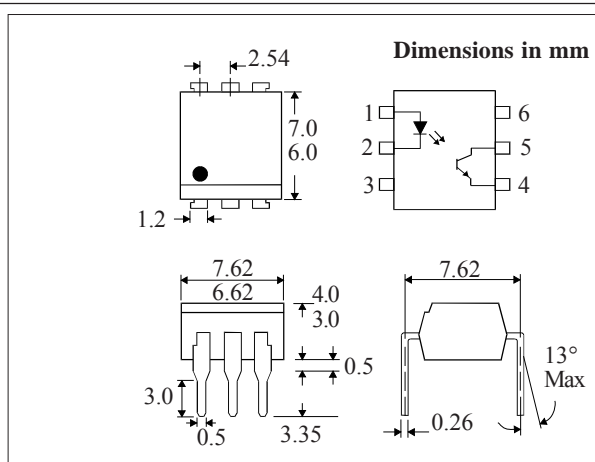

ABSOLUTE MAXIMUM RATINGS (25°C unless otherwise specified)

Storage Temperature _____ -55°C to +150°C
 Operating Temperature _____ -55°C to +100°C
 Lead Soldering Temperature
 (1/16 inch (1.6mm) from case for 10 secs) 260°C

INPUT DIODE

Forward Current _____ 60mA
 Reverse Voltage _____ 6V
 Power Dissipation _____ 105mW

OUTPUT TRANSISTOR

Collector-emitter Voltage BV_{CEO} _____ 70V
 Emitter-collector Voltage BV_{ECO} _____ 6V
 Collector Current _____ 50mA
 Power Dissipation _____ 160mW

POWER DISSIPATION

Total Power Dissipation _____ 200mW
 (derate linearly 2.67mW/°C above 25°C)

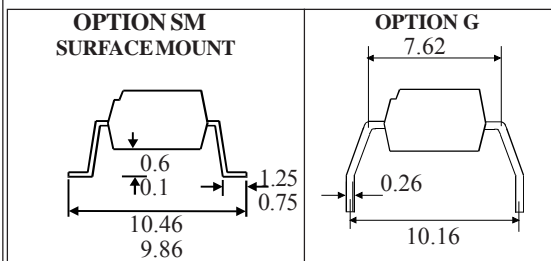

ISOCOM COMPONENTS LTD
 Unit 25B, Park View Road West,
 Park View Industrial Estate, Brenda Road
 Hartlepool, TS25 1UD England Tel:
 (01429)863609 Fax: (01429)863581 e-mail
 sales@isocom.co.uk http://www.isocom.com

ELECTRICAL CHARACTERISTICS ($T_A = 25^\circ\text{C}$ Unless otherwise noted)

PARAMETER		MIN	TYP	MAX	UNITS	TEST CONDITION
Input	Forward Voltage (V_F)		1.2	1.65	V	$I_F = 60\text{mA}$
	Reverse Current (I_R)			10	μA	$V_R = 6\text{V}$
Output	Collector-emitter Breakdown (BV_{CE0}) (note 2)	70			V	$I_C = 1\text{mA}$
	Emitter-collector Breakdown (BV_{ECO})	6			V	$I_E = 100\mu\text{A}$
	Collector-emitter Dark Current (I_{CEO})			50	nA	$V_{CE} = 10\text{V}$
Coupled	Current Transfer Ratio (CTR) (Note 2)					
	CNY17F-1	40	80		%	$10\text{mA } I_F, 5\text{V } V_{CE}$
	CNY17F-2	63	125		%	$10\text{mA } I_F, 5\text{V } V_{CE}$
	CNY17F-3	100	200		%	$10\text{mA } I_F, 5\text{V } V_{CE}$
	CNY17F-4	160	320		%	$10\text{mA } I_F, 5\text{V } V_{CE}$
	Collector-emitter Saturation Voltage $V_{CE(SAT)}$			0.4	V	$10\text{mA } I_F, 2.5\text{mA } I_C$
	Input to Output Isolation Voltage V_{ISO}	5300			V_{RMS}	See note 1
	7500			V_{PK}	See note 1	
	Input-output Isolation Resistance R_{ISO}	5×10^{10}			Ω	$V_{IO} = 500\text{V}$ (note 1)

Note 1 Measured with input leads shorted together and output leads shorted together.

Note 2 Special Selections are available on request. Please consult the factory.

TYPICAL SWITCHING CHARACTERISTICS

1. Linear Operation (without saturation) Fig 1.
 $I_F = 10\text{mA}, V_{CC} = 5\text{V}, R_L = 75\Omega$

			UNITS
Turn-on Time	t_{on}	3.0	μs
Rise Time	t_r	2.0	μs
Turn-off Time	t_{off}	2.3	μs
Fall Time	t_f	2.0	μs
Cut-off Frequency	F_{CO}	250	kHz

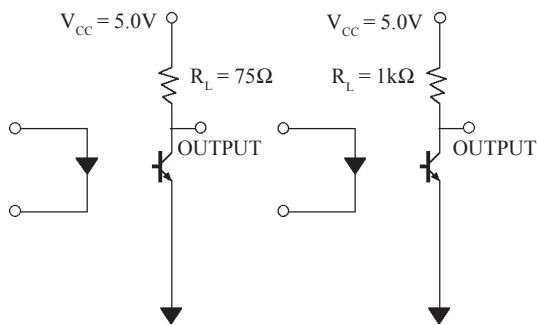
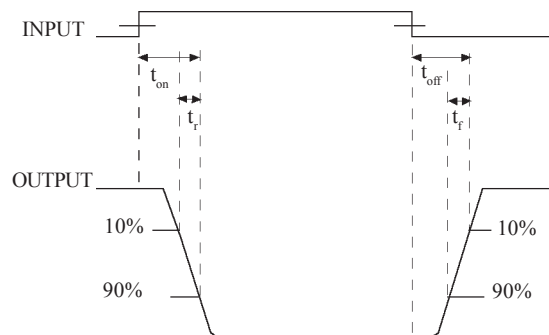

FIG 1

FIG 2

2. Switching Operation (with saturation) Fig 2
 $V_{CC} = 5\text{V}, R_L = 1\text{k}\Omega$

GROUP	-1 ($I_F = 20\text{mA}$)	-2 and -3 ($I_F = 10\text{mA}$)	-4 ($I_F = 5\text{mA}$)	UNITS	
Turn-on Time	t_{on}	3.0	4.2	6.0	μs
Rise Time	t_r	2.0	3.0	4.6	μs
Turn-off Time	t_{off}	18	23	25	μs
Fall Time	t_f	11	14	15	μs
	V_{CESAT}	≤ 0.4			V



Collector Power Dissipation vs. Ambient Temperature

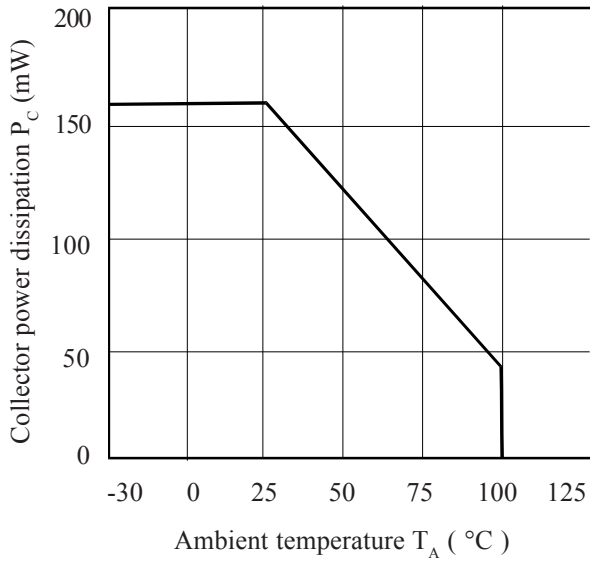

Collector Current vs. Collector-emitter Voltage (normalised to CNY17F-3)

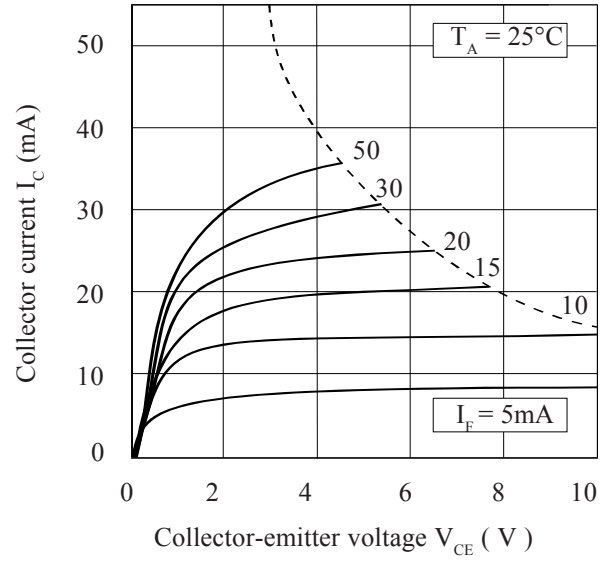

Forward Current vs. Ambient Temperature

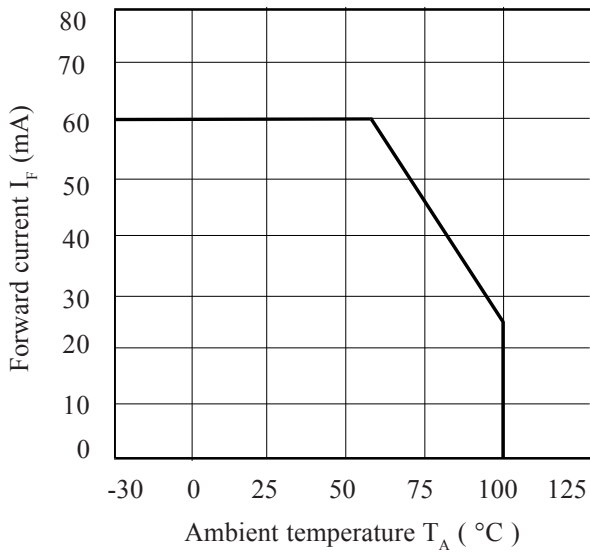

Current Transfer Ratio vs. Forward Current

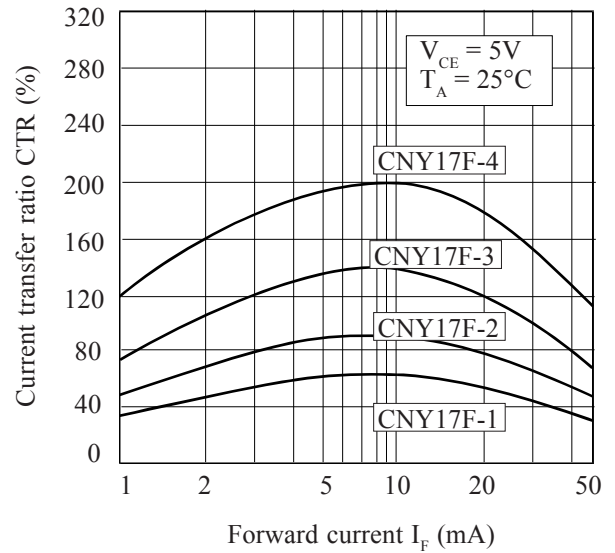

Relative Current Transfer Ratio vs. Ambient Temperature

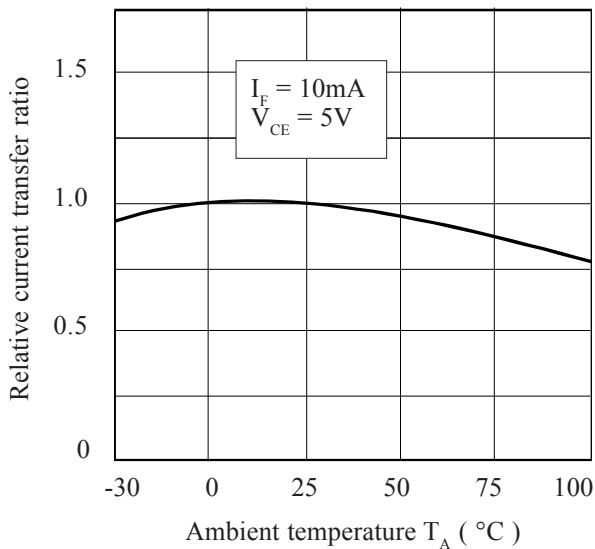

Collector-emitter Saturation Voltage vs. Ambient Temperature

