

2W

DC-DC POWER SUPPLIES

The single output isolated 2W product series is an ideal solution for isolating voltage rails in a distributed power supply architecture such as analog, digital, data and relay circuits. This product family offers a compact design with high efficiency, 1.5kV isolation with 3.0kV optional, short circuit protection and high operating temperature.



Features

- Unregulated single output
- $\pm 10\%$ input range
- Single outputs 3.3 to 24VDC
- SMD8 DIP package
- 1.5kVDC isolation, 3kVDC option
- Continuous short circuit protection
- Operating temperature -40°C to $+105^{\circ}\text{C}$
- Full load to $+85^{\circ}\text{C}$
- 3 year warranty

Applications



Industry 4.0



Instrumentation



Laboratory

Dimensions

0.52" x 0.335" x 0.285" (13.2 x 8.5 x 7.25 mm)

Models & Ratings

Model Number ^(4,5)	Input Voltage	Output Voltage	Input Current ⁽¹⁾		Output Current		Maximum Capacitive Load	Efficiency ⁽²⁾			
			No Load	Full Load	Minimum	Maximum					
IES0205S3V3	5V (4.5-5.5V)	3.3V	8mA	357mA	40mA	400mA	2400 μ F	78%			
IES0205S05		5V		500mA	40mA	400mA	2400 μ F	84%			
IES0205S07		6V		500mA	29mA	286mA	1000 μ F	84%			
IES0205S09		9V		494mA	22mA	222mA	1000 μ F	85%			
IES0205S12		12V		494mA	17mA	167mA	560 μ F	85%			
IES0205S15		15V		488mA	13mA	133mA	560 μ F	86%			
IES0205S24		24V		488mA	8mA	83mA	220 μ F	86%			
IES0212S05	12V (10.8 - 13.2V)	5V	8mA	196mA	40mA	400mA	2400 μ F	83%			
IES0212S09		9V			22mA	222mA	1000 μ F	83%			
IES0212S12		12V			17mA	167mA	560 μ F	84%			
IES0212S15		15V			13mA	133mA	560 μ F	84%			
IES0212S24		24V			8mA	83mA	220 μ F	85%			
IES0215S05	15V (13.5-16.5V)	5V	8mA	161mA	40mA	400mA	2400 μ F	83%			
IES0215S15		15V			13mA	133mA	560 μ F	84%			
IES0224S05	24V (21.6 - 26.4V)	5V	8mA	98mA	40mA	400mA	2400 μ F	83%			
IES0224S09		9V			22mA	222mA	1000 μ F	83%			
IES0224S12		12V			17mA	167mA	560 μ F	84%			
IES0224S15		15V			13mA	133mA	560 μ F	84%			
IES0224S24		24V						8mA	83mA	220 μ F	85%

Notes:

1. Typical input currents measured at nominal input voltage.
2. Typical value at full load.
3. Standard tube quantity = 38.

4. For tape & reel option add suffix -TR. Reel quantity = 500.
5. Optional 3kVDC isolation add suffix '-H'.

Input

Characteristic	Minimum	Typical	Maximum	Units	Notes & Conditions
Input Voltage	4.5		26.4	VDC	See Models and Ratings table
Input Reflected Ripple		15/30	63	mA pk-pk	Through 4.7μH inductor and 220μF capacitor, 5V input/other models
Input Surge			9	VDC	IES0205 for max 1s
			18		IES0212 for max 1s
			21		IES0215 for max 1s
			30		IES0224 for max 1s
Input Current	See models and ratings table				
Input Filter	Capacitor				

Output

Characteristic	Minimum	Typical	Maximum	Units	Notes & Conditions
Output Voltage	3.3		24	VDC	See Models and Ratings table
Initial Set Accuracy	See Load Regulation curves				
Minimum Load	10			%	
Line Regulation			±1.2	%	Per ±1% change of input voltage
Load Regulation	See Load Regulation curves				
Ripple and Noise		50/75	150/200	mV pk-pk	Other models/IES0205 20MHz bandwidth, measured using 0.1μF capacitor
Short Circuit Protection	Continuous, with auto recovery				
Maximum Capacitive Load	See Models and Ratings table				
Temperature Coefficient			±0.02	%/°C	

General

Characteristic	Minimum	Typical	Maximum	Units	Notes & Conditions
Efficiency	See Models and Ratings table				
Isolation: Input to Output	1500/3000			VDC	IES/IES-H functional
Switching Frequency	260	270	278	kHz	Low input voltage 10% load to high input voltage at full load IES0205
		220			
Isolation Resistance	10 ⁹			Ω	Input to output, tested at 500VDC
Isolation Capacitance		20		pF	Input to output
Power Density			41.6	W/in ³	
Mean Time Between Failure	3500			khrs	MIL-HDBK-217F, 25°C GB.
Weight	0.003 (1.4)			lb(g)	
Recommended Solder Profile	IPC/JEDEC J-STD-020D.1, peak temp ≤245°C, max duration, ≤60s at 217°C				
MSL	Level 1				
Case Material	Black plastic, flame retardant UL94V-0				
Pin Material	Phosphor bronze, solder coated				
Water Wash	Non-soaking water wash with de-ionised water. Dry thoroughly.				

Environmental

Characteristic	Minimum	Typical	Maximum	Units	Notes & Conditions
Operating Temperature	-40		+105	°C	Derate from 100% load at +85°C or +70°C model dependent. See derating curve
Storage Temperature	-55		+125	°C	
Case Temperature			+115	°C	
Case Temperature Rise		25/15		°C	Ambient 25°C , 3V3 output/others
Operating Humidity			95	%RH	Non-condensing
Cooling	Natural convection				

Safety Approvals

Safety Agency	Standard	Notes & Conditions
UL	UL62368-1	Designed to meet
EN	EN62368-1	Designed to meet
CE	Meets all applicable directives	
UKCA	Meets all applicable legislation	

EMC: Emissions

Phenomenon	Standard	Test Level	Notes & Conditions
Conducted	EN55032	Class B	See Application Note for Class B filter
Radiated	EN55032	Class B	

EMC: Immunity

Phenomenon	Standard	Test Level	Criteria	Notes & Conditions
ESD Immunity	EN61000-4-2	±4kV contact / ±8kV air discharge	B	

Load Regulation

5V Input Series

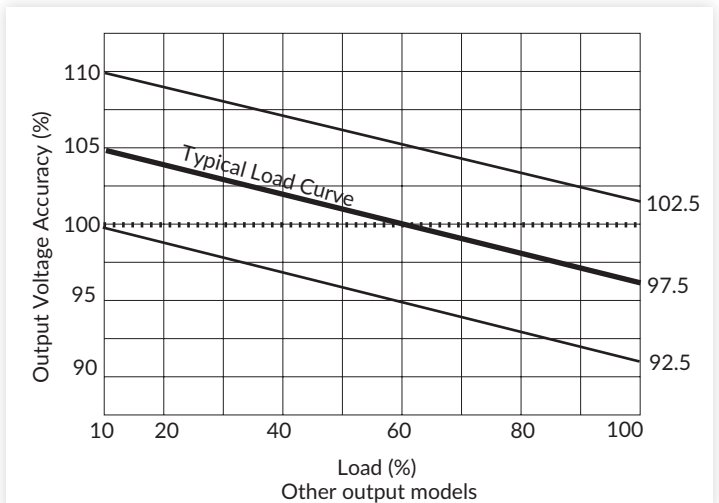
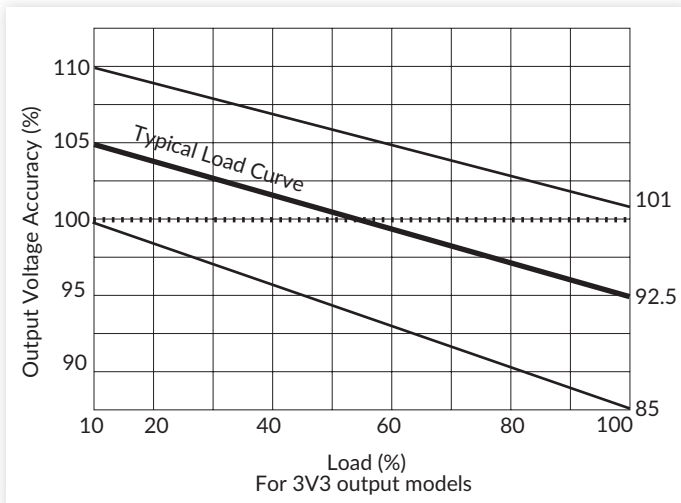

Application Notes

Other Input Series

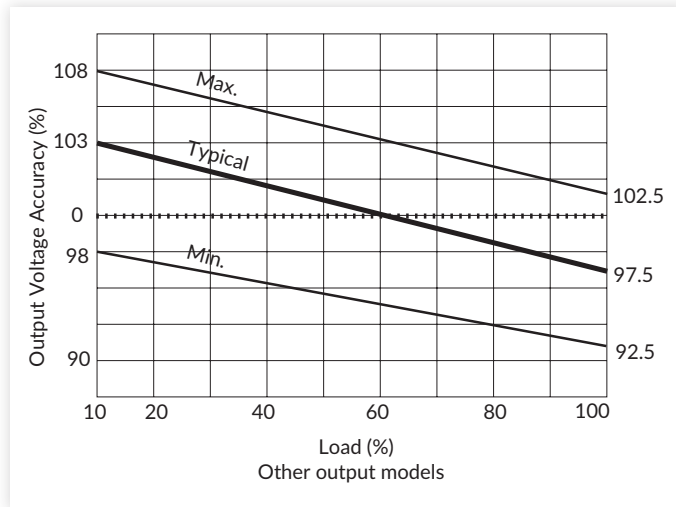

EMI Filter for Class B Emissions

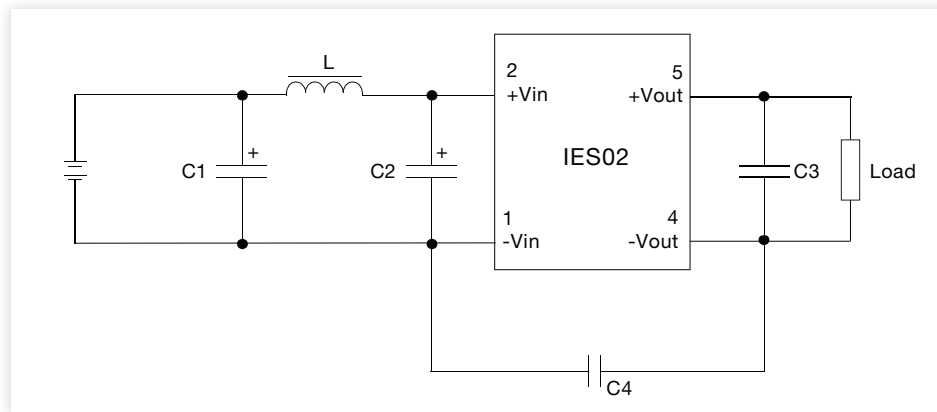

5V Input:					
Output Voltage	C1, C2	C3	C4	L	
3.3V	4.7µF, 16V	10µF, 16V	270pF	6.8µH	
5V		4.7µF, 16V			4.7µF, 16V
7V					2.2µF, 25V
9V					1µF, 25V
12V					0.47µF, 50V
15V					
24V					

C4: 2kV, ceramic. Upgrade C4 to 4kV for 3kV isolation option -H.

Other Input Series:					
Output Voltage	C1, C2	C3	C4	L	
5V	4.7µF, 50V	10µF, 10V	270pF	6.8µH	
9V		4.7µF, 50V			2.2µF, 25V
12V					2.2µF, 25V
15V					1µF, 25V
24V					0.47µF, 50V

C4: 2kV, ceramic. Upgrade C4 to 4kV for 3kV isolation option -H.

Application Notes

Temperature Derating Curve

IES0212, 15 & 24

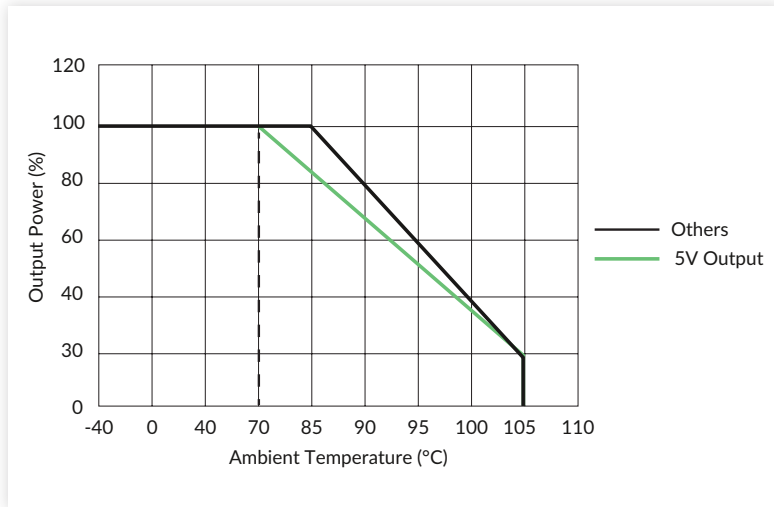

IES0205S05

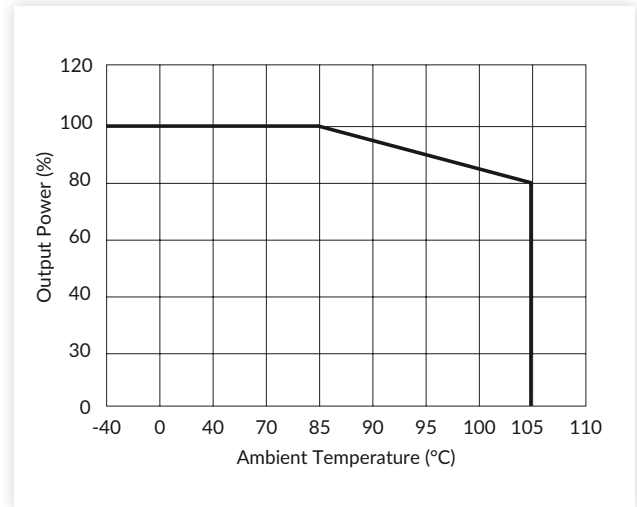

Efficiency Curves

Efficiency vs Input Voltage (IES0205S05)

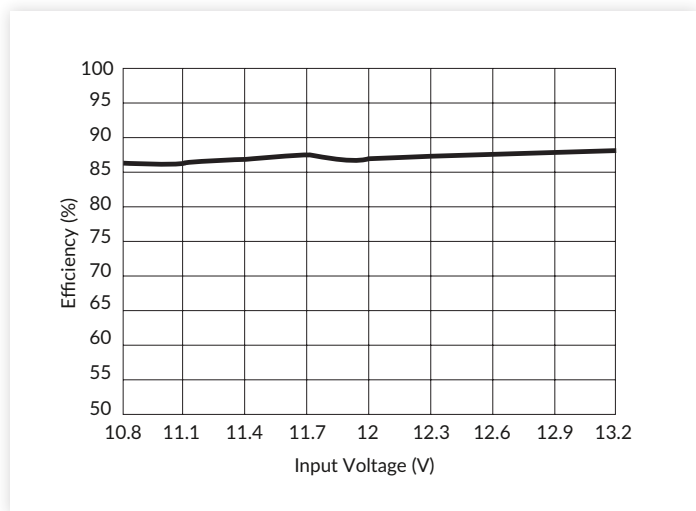

Efficiency vs Output Load (IES0205S05)

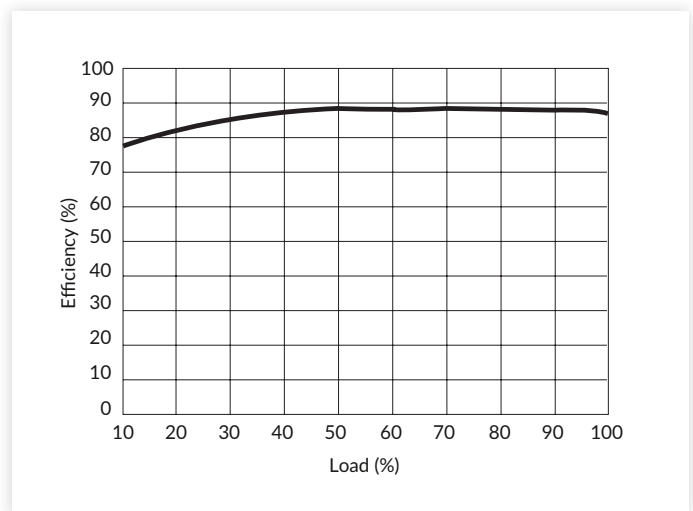

Mechanical Details

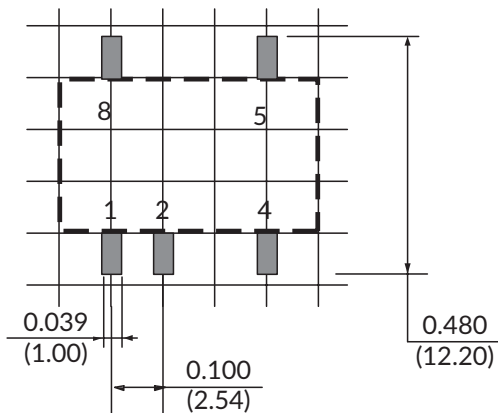
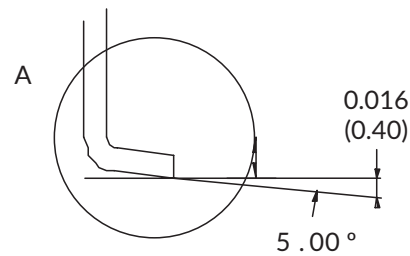
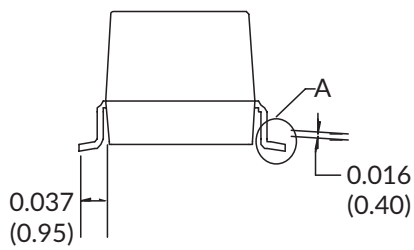
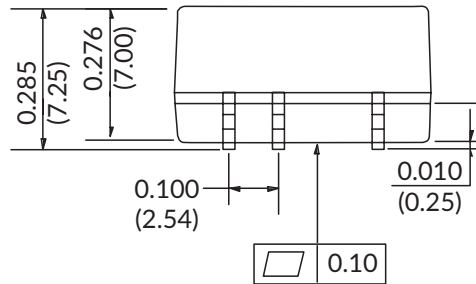
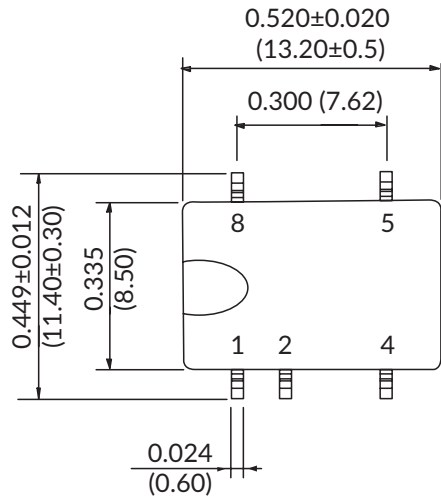

Pin Connections	
Pin	Function
1	-Vin
2	+Vin
4	-Vout
5	+Vout
8	No Connection ⁵⁾

Recommended Footprint
 Top View grid: 0.1 x 0.1 in (2.54 x 2.54 mm)

Notes:

- All dimensions are in inches (mm).
- Weight: 0.003lbs (1.4g) typical.
- Pin pitch and length tolerance: ±0.004 (±0.10).
- Case tolerance: ±0.02 (±0.5).
- Pin 8 leave floating.

Mouser Electronics

Authorized Distributor

Click to View Pricing, Inventory, Delivery & Lifecycle Information:

[XP Power:](#)

[IES0205S05](#) [IES0205S07](#) [IES0205S09](#) [IES0205S12](#) [IES0205S15](#) [IES0205S24](#) [IES0205S3V3](#) [IES0212S05](#)
[IES0212S09](#) [IES0212S12](#) [IES0212S15](#) [IES0212S24](#) [IES0215S05](#) [IES0215S15](#) [IES0224S05](#) [IES0224S09](#)
[IES0224S12](#) [IES0224S15](#) [IES0224S24](#)