

PART NO.
20021221

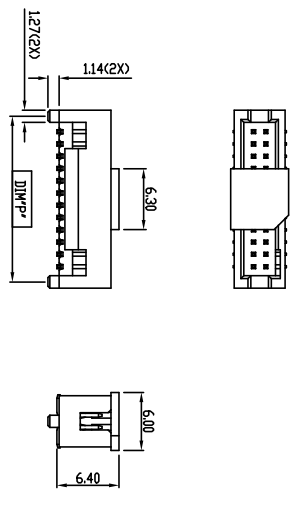

SCALE 2.000
PRODUCT WITH CAP AND POST OPTION

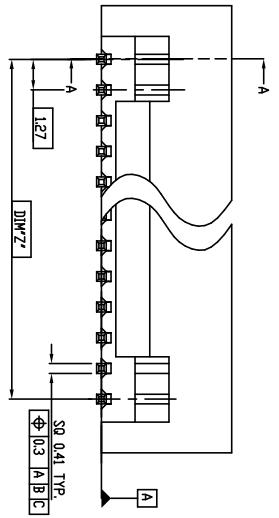
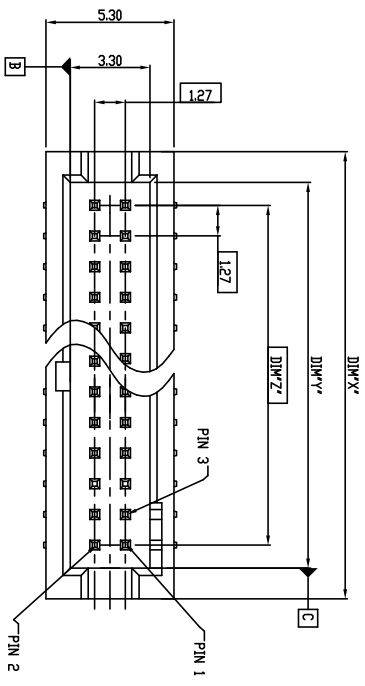
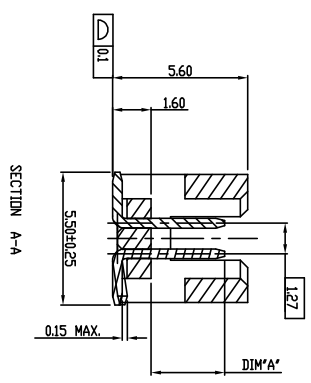

- NOTES:
- 1.MATERIAL: HIGH TEMPERATURE THERMOPLASTIC, UL94-V0 BLACK.
 - 2.TERMINAL: COPPER ALLOY
 - 3.TERMINAL: ONLY SHOWN THE FEATURE OF THE ABSENT PIN, THE OTHER SPEC IS THE SAME AS THE FULL PIN PRODUCT.
 - 4.THE HOUSING WILL WITHSTAND EXPOSURE TO 260°C PEAK TEMPERATURE FOR 10 SECONDS IN A CONVECTION INFRA-RED DR VAPOR PHASE REFLOW OVEN.
 - 5.THE PRODUCT MEETS EUROPEAN UNION DIRECTIVES AND OTHER COUNTRY REGULATIONS AS DESCRIBED IN GS-22-008.
 - 6.PRODUCT SPEC: GS-12-629
 - 7.THE METAL CAP IS OPTION AS CUSTOMER REQUIREMENT.
 - 8.20021221-00312CALF FOR CUSTOMER SPECIFIED WITH 0.76µm MIN. Au AT CONTACT, 127µm MIN. MATTE TIN AT TAIL.

mat'l. code	surface	tolerance	projection	product family
	ISO 1302	ISO 406	ISO 11081	MINITEK127®
itr ecn no dr	date	tolerances unless otherwise specified	mm	title
N EX-N-23548 TIM	03/21/16	angle	0.5:30	SHROUDED HDR VT SMT
P EX-N-24142 TIM	05/23/16	linear	0.0±.20	
R EX-N-30802 TONY	2018-07-26	0±.2°	0.00±.10	scale 1:1
S EX-N-31947 TONY	2018-11-23	dr		
	eng	ZK HU	08/07/12	Amphenol FCI
	chr	BIAN RICK	08/07/12	
	pppd	BIAN RICK	08/07/12	
sheet revision	S	S	S	type
index sheet	1	2	3	Product Customer Drawing

1 2 3 4 5 6

PART NO.	PQS	DM*1	DM*2	DM*3	DM*4
20021221-XXXX06XLF	2 X 3	6.99	4.45	2.54	5.72
20021221-XXXX08XLF	2 X 4	8.26	5.72	3.81	6.99
20021221-XXXX10XLF	2 X 5	9.53	6.99	5.08	8.26
20021221-XXXX12XLF	2 X 6	10.80	8.26	6.35	9.53
20021221-XXXX14XLF	2 X 7	12.07	9.53	7.62	10.80
20021221-XXXX16XLF	2 X 8	13.34	10.80	8.89	12.07
20021221-XXXX18XLF	2 X 9	14.61	12.07	10.16	13.34
20021221-XXXX20XLF	2 X 10	15.88	13.34	11.43	14.61
20021221-XXXX22XLF	2 X 11	17.15	14.61	12.70	15.88
20021221-XXXX24XLF	2 X 12	18.42	15.88	13.97	17.15
20021221-XXXX26XLF	2 X 13	19.69	17.15	15.24	18.42
20021221-XXXX28XLF	2 X 14	20.96	18.42	16.51	19.69
20021221-XXXX30XLF	2 X 15	22.23	19.69	17.78	20.96
20021221-XXXX32XLF	2 X 16	23.50	20.96	19.05	22.23
20021221-XXXX34XLF	2 X 17	24.77	22.23	20.32	23.50
20021221-XXXX36XLF	2 X 18	26.04	23.50	21.59	24.77
20021221-XXXX38XLF	2 X 19	27.31	24.77	22.86	26.04
20021221-XXXX40XLF	2 X 20	28.58	26.04	24.13	27.31
20021221-XXXX42XLF	2 X 21	29.85	27.31	25.40	28.58
20021221-XXXX44XLF	2 X 22	31.12	28.58	26.67	29.85
20021221-XXXX46XLF	2 X 23	32.39	29.85	27.94	31.12
20021221-XXXX48XLF	2 X 24	33.66	31.12	29.21	32.39
20021221-XXXX50XLF	2 X 25	34.93	32.39	30.48	33.66
20021221-XXXX52XLF	2 X 26	36.20	33.66	31.75	34.93
20021221-XXXX54XLF	2 X 27	37.47	34.93	33.02	36.20
20021221-XXXX56XLF	2 X 28	38.74	36.20	34.29	37.47
20021221-XXXX58XLF	2 X 29	40.01	37.47	35.56	38.74
20021221-XXXX60XLF	2 X 30	41.28	38.74	36.83	40.01
20021221-XXXX62XLF	2 X 31	42.55	40.01	38.10	41.28
20021221-XXXX64XLF	2 X 32	43.82	41.28	39.37	42.55
20021221-XXXX66XLF	2 X 33	45.09	42.55	40.64	43.82
20021221-XXXX68XLF	2 X 34	46.36	43.82	41.91	45.09
20021221-XXXX70XLF	2 X 35	47.63	45.09	43.18	46.36
20021221-XXXX72XLF	2 X 36	48.90	46.36	44.45	47.63
20021221-XXXX74XLF	2 X 37	50.17	47.63	45.72	48.90
20021221-XXXX76XLF	2 X 38	51.44	48.90	46.99	50.17
20021221-XXXX78XLF	2 X 39	52.71	50.17	48.26	51.44
20021221-XXXX80XLF	2 X 40	53.98	51.44	49.53	52.71
20021221-XXXX82XLF	2 X 41	55.25	52.71	50.80	53.98
20021221-XXXX84XLF	2 X 42	56.52	53.98	52.07	55.25
20021221-XXXX86XLF	2 X 43	57.79	55.25	53.34	56.52
20021221-XXXX88XLF	2 X 44	59.06	56.52	54.61	57.79
20021221-XXXX90XLF	2 X 45	60.33	57.79	55.88	59.06
20021221-XXXX92XLF	2 X 46	61.60	59.06	57.15	60.33
20021221-XXXX94XLF	2 X 47	62.87	60.33	58.42	61.60
20021221-XXXX96XLF	2 X 48	64.14	61.60	59.69	62.87
20021221-XXXX98XLF	2 X 49	65.41	62.87	60.96	64.14
20021221-XXXX00XLF	2 X 50	66.68	64.14	62.23	65.41

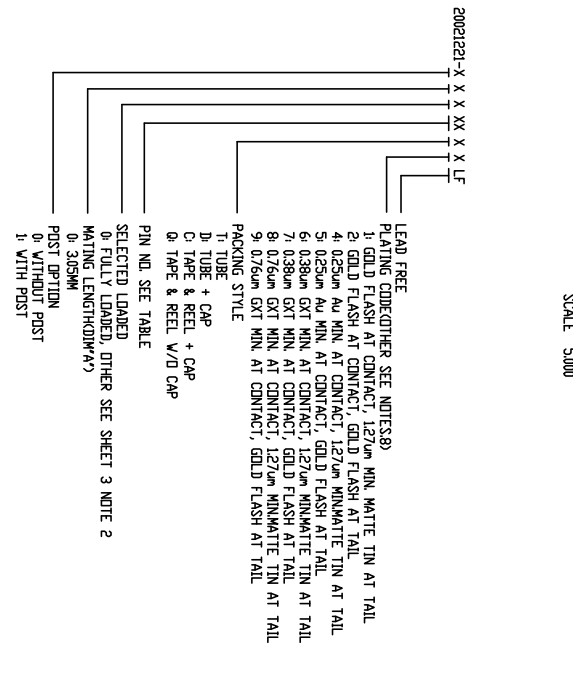
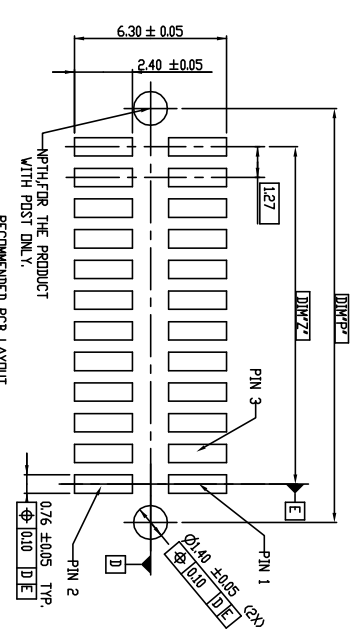

mat'l. code	surface	tolerance	projection	product family
	ISO 1302	ISO 406	ISO 11081	MINI/TEK127®
	tolerances unless otherwise specified			
	angle	.0±.30	mm	
	line ar	.00±.20	mm	
	dr	±.10	mm	
	eng	ZK HU	08/07/12	
	chr	BIAN RICK	08/07/12	
	pppd	BIAN RICK	08/07/12	
	sheet	revision		
	index	sheet		

product family	title	dwg no	sheet	of 3	size
MINI/TEK127®	SHROUDED HDR VT SMT	20021221	2	3	A3

PART NUMBER 20021221-XX214XXLF
REMOVE PIN 1 FOR REFERENCE

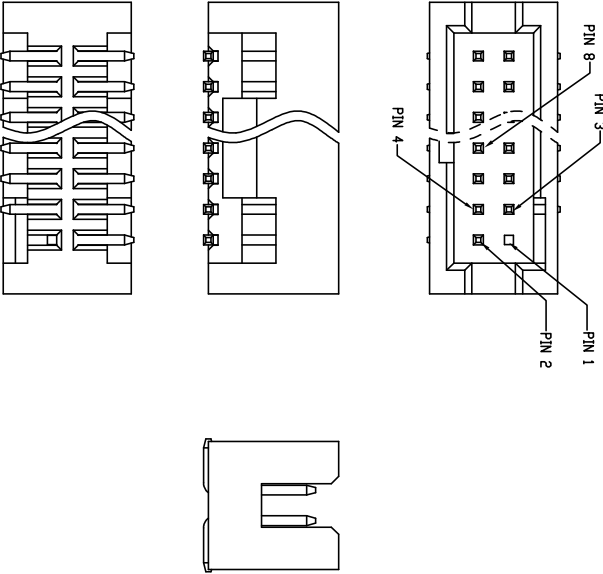

PART NUMBER	AMOUNT OF PINS	PIN FREE LEADED
20021221-XX108XXLF	7	PIN #3
20021221-XX110XXLF	9	PIN #3
20021221-XX214XXLF	13	PIN #1
20021221-XX206XXLF	5	PIN #1
20021221-XX312XXLF	11	PIN #8
20021221-XX410XXLF	9	PIN #4

mat'l. code	surface	tolerance	projection	product family
itr ecn no/dr	ISO 1302	ISO 406	ISO 11081	MINITEK127®
date	tolerances unless otherwise specified		mm	title
angle	linear	.02±.30	mm	SHROUDED HDR VT SMT
0±.2°	.000±.10	scale 1:1		dwg no
dr	ZK HU	08/07/12		20021221
eng	ZK HU	08/07/12		sheet 3 of 3
chr	BIAN RICK	08/07/12		size
appd	BIAN RICK	08/07/12		A3
sheet revision				type
index sheet				Product Customer Drawing