

MICRO SWITCH™ NT Series

Step Base Toggle Switch

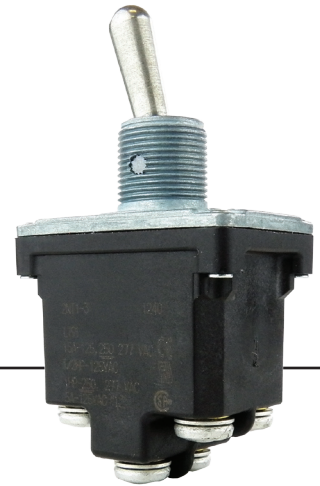

DESCRIPTION

Honeywell MICRO SWITCH™ NT Series toggle switches meet the need for a rugged, cost-effective toggle switch. Quality construction features include a seal between the toggle lever and bushing, and between the cover and case. These switches can be used where panels are subject to splashes, hose downs, or outdoor environments. Complete sealing of the switching chamber enables NT toggles to comply with UL 508, paragraph 13.3 hose down test. They will also withstand exposure to heavy

accumulations of early morning dew that may condense on the control panel in cabs of vehicles left outdoors overnight.

The “Easy Start” threaded bushing enables quick alignment of the mounting nut to decrease the chance of cross threading. The panel stand-off with O-ring feature available on some listings eliminates the need for behind-the-panel hardware, provides a uniform panel height, and provides a panel-to-cover seal.

FEATURES

- Completely sealed switching chamber
- IP67/IP68
- NEMA 3, 3R, 4, 13
- 2- or 3-position maintained and momentary action
- Step-design case provides added space between terminals to prevent shorting
- Spring-loaded actuating mechanism provides excellent tactile feedback
- UL recognized, File E12252, Vol. 1, Section 44
- CSA certified, CE certified
- Optional panel stand-off with O-ring panel seal

POTENTIAL APPLICATIONS

Aerospace/Military

- Military and commercial aviation

Industrial

- Construction equipment
- Industrial equipment
- Process control
- Test instruments

Medical

- Medical instrumentation

Transportation

- Agricultural machinery

MICRO SWITCH™ NT Series

SPECIFICATIONS

Characteristic	Parameter
Description	Industrial-grade toggle switch (flat base)
Sealing	IP67/IP68; NEMA 3, 3R, 4, and 13
Operating temperature	-40 °C to 71 °C [-40 °F to 160 °F]
Actuators	Standard, locking, special design, tab
Action	2- or 3- position; momentary and maintained
Mounting	Bushing 15/32 in
Circuitry	SPST, SPDT, DPST, DPDT, 4PST, 4PDT
Terminations	Solder, screw, quick connect
Contacts	Silver alloy
Amp rating	Up to 20 A (resistive)
Approvals	UL, CSA, CE
Measurement	26,7 mm H x 33,5 mm W x 22,6 mm D [1.05 in H x 1.32 in W x 0.89 in D]

UL AND CSA ELECTRICAL RATINGS

Rating Code	Electrical rating
L192	10 amps, 125, 250, 277 Vac; ¼ Hp, 125 Vac; ½ Hp, 250, 277 Vac; 3 amps, 125 Vac "L"
L191	15 amps, 125, 250, 277 Vac; ½ Hp, 125 Vac; 1 Hp, 250, 277 Vac; 5 amps, 125 Vac "L"

ELECTRICAL RATINGS

Electrical Rating Code	28 Vdc			115 Vdc	250 Vdc	115 Vac, 60 Hz & 400 Hz			230 Vac
	Ind.	Res.	Lamp	Res.	Res.	Ind.	Res.	Lamp	Res
1	12	20	5	0.75	0.5	10	15	3	6
2	10	15	4	0.75	0.5	7	15	2	6
3	15	20	7	0.75	0.5	15	15	4	6
4	10	18	5	0.75	0.5	8	11	2	6

Step-Base Toggle Switch

STANDARD ACTUATOR OPTIONS, TERMINALS, & DIMENSIONS

Note: Single pole NT switches shown

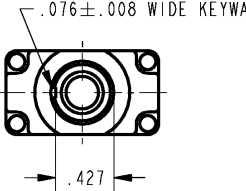
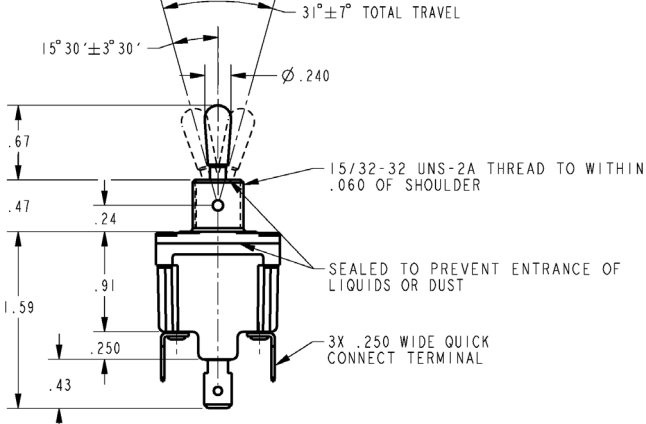
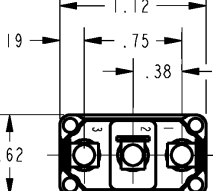
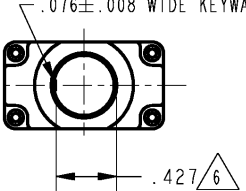
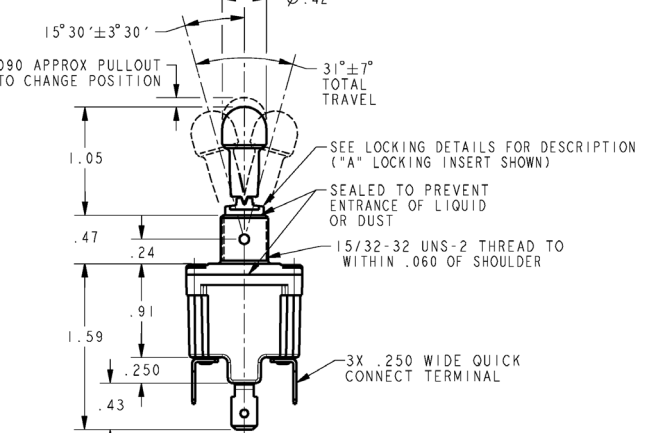
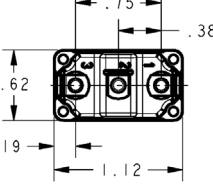
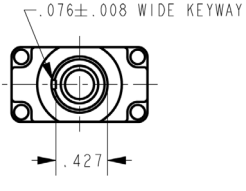
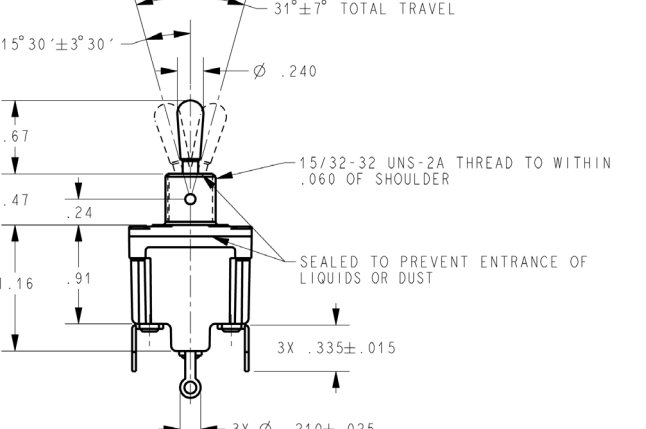
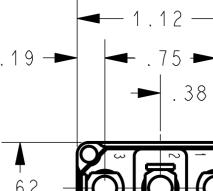
Description	Top	Front	Bottom
Standard Lever, QC Terminals			
Locking Lever, QC Terminals			
Standard Lever, Solder Terminals			

MICRO SWITCH™ NT Series

STANDARD ACTUATOR OPTIONS, TERMINALS, & DIMENSIONS

Note: Single pole NT switches shown

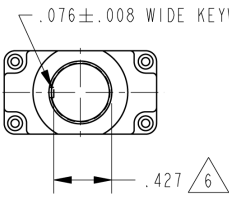
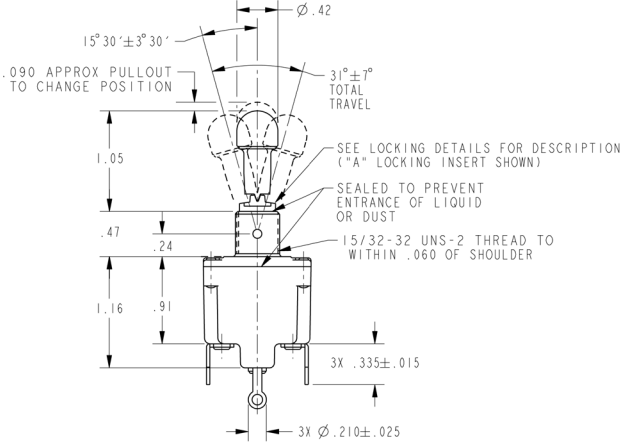
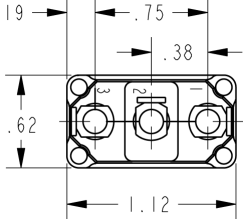
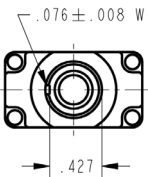
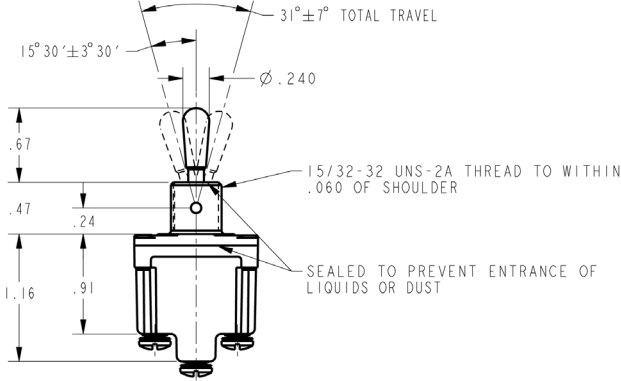
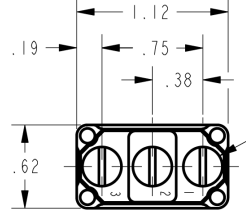
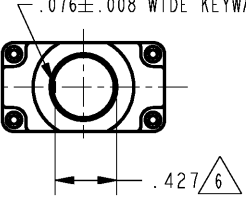
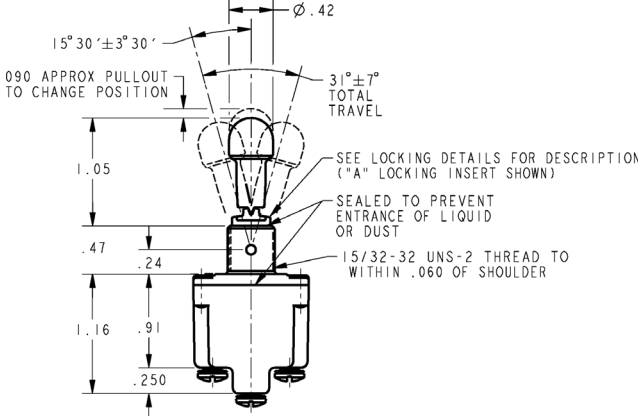
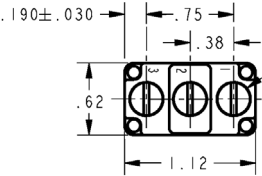
Description	Top	Front	Bottom
Locking Lever, Solder Terminals			
Standard Lever, Screw Terminals			
Locking Lever, Screw Terminals			

Step-Base Toggle Switch

STANDARD ACTUATOR OPTIONS, TERMINALS, & DIMENSIONS

Note: Single pole NT switches shown

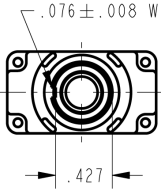
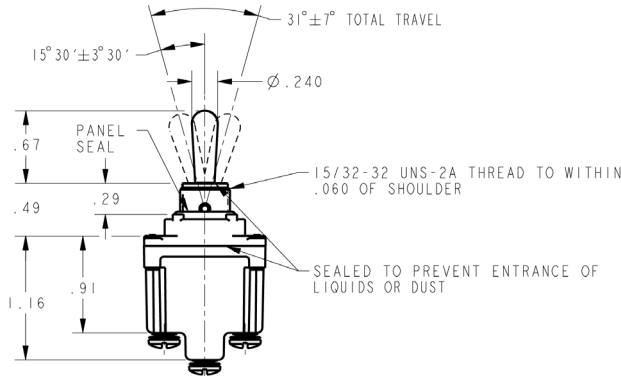
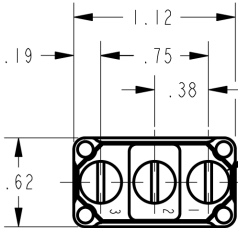
Description	Top	Front	Bottom
Standard Lever Panel Stand-off Feature Screw Terminals	 <p>.076 ± .008 WIDE KEYWAY</p> <p>.427</p>	 <p>15° 30' ± 3° 30'</p> <p>31° ± 7° TOTAL TRAVEL</p> <p>∅ .240</p> <p>PANEL SEAL</p> <p>15/32-32 UNS-2A THREAD TO WITHIN .060 OF SHOULDER</p> <p>SEALED TO PREVENT ENTRANCE OF LIQUIDS OR DUST</p> <p>.67</p> <p>.49</p> <p>.29</p> <p>1.16</p> <p>.91</p>	 <p>1.12</p> <p>.19</p> <p>.75</p> <p>.38</p> <p>.62</p>

MICRO SWITCH™ NT Series

NT 2-POSITION ORDER GUIDE

No. of poles	Circuits Made with Toggle At:			Catalog Listing (Standard Lever)				Pull-To-Unlock Lever (Add suffix to Standard Lever Listing)
	Keyway Position	Opposite Keyway	UL Rating Code	Elect. Rating Code	Screw	Solder	Q-C	
1	OFF	2-3	L191	1	1NT1-2	11NT1-2	1NT91-2	D, F, G
	1-2	2-3	L191	1	1NT1-3	11NT1-3	1NT91-3	D, F, G
	OFF*	2-3	L192	2	1NT1-4	11NT1-4	1NT91-4	F
	1-2*	OFF	L192	2	1NT1-6	11NT1-6	1NT91-6	F
	1-2*	2-3	L192	2	1NT1-8	11NT1-8	1NT91-8	F
2	OFF	2-3, 5-6	L191	3	2NT1-2	12NT1-2	2NT91-2	D, F, G
	1-2, 4-5	2-3, 5-6	L191	3	2NT1-3	12NT1-3	2NT91-3	F
	OFF*	2-3, 5-6	L192	4	2NT1-4	12NT1-4	2NT91-4	F
	1-2, 4-5*	OFF	L192	4	2NT1-6	12NT1-6	2NT91-6	D, F, G
	1-2, 4-5*	2-3, 5-6	L192	4	2NT1-8	12NT1-8	2NT91-8	F
4	OFF	2-3, 5-6, 8-9, 11-12	L191	5	4NT1-2	14NT1-2	4NT91-2	D, F, G
	1-2, 4-5, 7-8, 10-11	2-3, 5-6, 8-9, 11-12	L191	5	4NT1-3	14NT1-3	4NT91-3	F
	OFF*	2-3, 5-6, 8-9, 11-12	L192	6	4NT1-4	14NT1-4	4NT91-4	F
	1-2, 4-5, 7-8, 10-11*	OFF	L192	6	4NT1-6	14NT1-6	4NT91-6	D, F, G
	1-2, 4-5, 7-8, 10-11*	2-3, 5-6, 8-9, 11-12	L192	6	4NT1-8	14NT1-8	4NT91-8	F

NT 2-POSITION ORDER GUIDE • PANEL STAND-OFF FEATURE

No. of poles	Circuits Made with Toggle At:			Elect. Rating Code	Catalog Listing Screw
	Keyway Position	Opposite Keyway	UL Rating Code		
1	OFF	2-3	L191	1	61NT1-2
	1-2	2-3	L191	1	61NT1-3
	1-2*	OFF	L192	2	61NT1-6
	1-2*	2-3	L192	2	61NT1-8
2	OFF	2-3, 5-6	L191	3	62NT1-2
	1-2, 4-5	2-3, 5-6	L191	3	62NT1-3
	1-2, 4-5*	OFF	L192	4	62NT1-6
	1-2, 4-5*	2-3, 5-6	L192	4	62NT1-8

*These positions are momentary. All others are maintained.

NT 3-POSITION ORDER GUIDE • PANEL STAND-OFF FEATURE

No. of poles	Circuits Made with Toggle At:			UL Rating Code	Elect. Rating Code	Catalog Listing Screw
	Keyway Position	Center Position	Opposite Keyway			
1	1-2	OFF	2-3	L191	1	61NT1-1
	1-2*	OFF	2-3*	L192	2	61NT1-7
2	1-2, 4-5	OFF	2-3, 5-6	L191	3	62NT1-1
	1-2, 4-5	OFF	2-3, 5-6*	L192	4	62NT1-7

* These positions are momentary. All others are maintained.

Step-Base Toggle Switch

NT 3-POSITION ORDER GUIDE













No. of poles	Circuits Made with Toggle At:			Catalog Listing					Pull-To-Unlock Lever (Add suffix to Standard Lever Listing)
	Keyway Position	Center Position	Opposite Keyway	UL Rating Code	Elect. Rating Code	Screw	Solder	Q-C	
1	1-2	OFF	2-3	L191	1	1NT1-1	11NT1-1	1NT91-1	ALL TYPES
	1-2*	OFF	2-3	L192	2	1NT1-5	11NT1-5	1NT91-5	E, F, K, L, M, N
	1-2*	OFF	2-3*	L192	2	1NT1-7	11NT1-7	1NT91-7	E, L, N
	NONE**	OFF	2-3	L191	1	1NT1-21	11NT1-21	1NT91-21	E, F, K, M
	NONE**	1-2	2-3	L191	1	1NT1-31	11NT1-31	1NT91-31	E, F, K, M
	NONE**	1-2	2-3*	L192	2	1NT1-51	11NT1-51	1NT91-51	E
	1-2*	OFF	NONE**	L192	2	1NT1-61	11NT1-61	1NT91-61	E
2	1-2, 4-5	OFF	2-3, 5-6	L191	3	2NT1-1	12NT1-1	2NT91-1	ALL TYPES
	1-2, 4-5*	OFF	2-3, 5-6	L192	4	2NT1-5	12NT1-5	2NT91-5	E, F, K, L, M, N
	1-2, 4-5	OFF	2-3, 5-6*	L192	4	2NT1-7	12NT1-7	2NT91-7	E, L, N
	NONE*	OFF	2-3, 5-6	L191	3	2NT1-21	12NT1-21	2NT91-21	E, F, K, M
	NONE**	1-2, 4-5	2-3, 5-6	L191	3	2NT1-31	12NT1-31	2NT91-31	E, F, K, M
	NONE**	1-2, 4-5	2-3, 5-6*	L192	4	2NT1-51	12NT1-51	2NT91-51	E
	1-2, 4-5*	OFF	NONE**	L192	4	2NT1-61	12NT1-61	2NT91-61	E
	1-2, 4-5	2-3, 4-5	2-3, 5-6	L191	3	2NT1-12	12NT1-12	2NT91-12	ALL TYPES
	1-2, 4-5	1-2, 5-6	2-3, 5-6	L191	3	2NT1-10	12NT1-10	2NT91-10	ALL TYPES
	1-2, 4-5*	1-2, 5-6	2-3, 5-6	L192	4	2NT1-50	12NT1-50	2NT91-50	E, F, K, L, M, N
	1-2, 4-5	1-2, 5-6	2-3, 5-6*	L192	4	2NT1-70	12NT1-70	2NT91-70	E, L, N
4	1-2, 4-5, 7-8, 10-11	OFF	2-3, 5-6, 8-9, 11-12	L191	5	4NT1-1	14NT1-1	4NT91-1	ALL TYPES
	1-2, 4-5, 7-8, 10-11*	OFF	2-3, 5-6, 8-9, 11-12	L192	6	4NT1-5	14NT1-5	4NT91-5	E, F, K, L, M, N
	1-2, 4-5, 7-8, 10-11*	OFF	2-3, 5-6, 8-9, 11-12*	L192	6	4NT1-7	14NT1-7	4NT91-7	E, L, N
	NONE*	OFF	2-3, 5-6, 8-9, 11-12	L191	5	4NT1-21	14NT1-21	4NT91-21	E, F, K, M
	NONE**	1-2, 4-5, 7-8, 10-11	2-3, 5-6, 8-9, 11-12	L191	5	4NT1-31	14NT1-31	4NT91-31	E, F, K, M
	NONE**	1-2, 4-5, 7-8, 10-11	2-3, 5-6, 8-9, 11-12*	L192	6	4NT1-51	14NT1-51	4NT91-51	E
	1-2, 4-5, 7-8, 10-11*	OFF	NONE**	L192	6	4NT1-61	14NT1-61	4NT91-61	E
	1-2, 4-5, 7-8, 10-11	2-3, 4-5, 7-8, 11-12	2-3, 5-6, 8-9, 11-12	L191	5	4NT1-12	14NT1-12	4NT91-12	ALL TYPES
	1-2, 4-5, 7-8, 10-11	2-3, 4-5	2-3, 5-6, 8-9, 11-12	L191	5	4NT1-10	14NT1-10	4NT91-10	ALL TYPES
	1-2, 4-5, 7-8, 10-11*	2-3, 4-5, 7-8, 11-12	2-3, 5-6, 8-9, 11-12	L192	6	4NT1-50	14NT1-50	4NT91-50	E, F, K, L, M, N
	1-2, 4-5, 7-8, 10-11*	2-3, 4-5	2-3, 5-6, 8-9, 11-12*	L192	6	4NT1-70	14NT1-70	4NT91-70	E, L, N

* These positions are momentary. All others are maintained.

** Toggle lever is blocked from these products. Toggle becomes 2-position, with center being one extreme position.

MICRO SWITCH™ NT Series

MICRO SWITCH NT™ SERIES LOCKING CONFIGURATIONS

A  Locked In Three Positions	B  Locked In Center and Extreme Position (Keyway Side)	D  Locked Out Of Center Position	E  Locked In Center Position	F  Locked In Extreme Position (Opposite Keyway)	G  Locked In Extreme Position (Keyway Side)	H  Locked Out Of Center And Extreme Position (Keyway Side)
J  Locked Out Of Center And Extreme Position (Opposite Keyway)	K  Locked In Center And Extreme Position (Opposite Keyway)	L  Locked Out Of Extreme Position (Keyway Side)	M  Locked Out Of And Into Extreme Position (Opposite Keyway)	N  Locked Out Of Extreme Position (Opposite Keyway)	P  Locked Out Of And Into Extreme Position (Keyway Side)	

This Honeywell datasheet supports the following MICRO SWITCH™ NT Series Toggle Switch (Step Base) Listings

11NT1-1A	1NT1-3-C	1NT887-21K	2NT1-31	2NT91-10	4NT91-70
11NT1-2	1NT1-3D	1NT887-3	2NT1-3-C	2NT91-1A	611NT1-7
11NT1-3	1NT1-3F	1NT887-5	2NT1-3D	2NT91-2	61NT1-1
11NT1-3D	1NT1-3-JLG	1NT887-6	2NT1-3-JLG	2NT91-3	61NT1-1-NH
11NT1-3G	1NT1-3-NH	1NT887-7	2NT1-3-NH	2NT91-3D	61NT1-2
11NT1-5	1NT1-3-NH-ALT	1NT887-7E	2NT1-3-NH-ALT	2NT91-5	61NT1-3
11NT1-6	1NT1-3-TM	1NT887-8	2NT1-4	2NT91-50	61NT1-3-A04
11NT1-7	1NT1-4	1NT91-1	2NT1-5	2NT91-50K	61NT1-3-NH
11NT1-7-NH	1NT1-5	1NT91-1E	2NT1-50	2NT91-6	61NT1-5
12NT1-1	1NT1-51	1NT91-2	2NT1-50F	2NT91-7	61NT1-6
12NT1-10	1NT1-5-C	1NT91-3	2NT1-50-NH-ALT	2NT91-70	61NT1-6-A01
12NT1-2	1NT1-5N	1NT91-3D	2NT1-51	2NT91-7-NH	61NT1-7
12NT1-3	1NT1-5-TM	1NT91-5	2NT1-5M	2NT91-8	61NT1-7-NH
12NT1-7	1NT1-6	1NT91-5E	2NT1-5N	4NT1-1	61NT1-8
14NT1-3	1NT1-61	1NT91-6	2NT1-5-TM	4NT1-10	61NT1-8-NH
14NT1-5	1NT1-61-JLG	1NT91-61	2NT1-6	4NT1-10E	61NT887-1
14NT1-6	1NT1-6F	1NT91-7	2NT1-61	4NT1-119	61NT887-3
14NT1-7	1NT1-6-NH-ALT	2NT101-7	2NT1-61-JLG	4NT1-12	61NT887-5
14NT1-8	1NT1-6-TM	2NT1-1	2NT1-6-NH-ALT	4NT1-12A	61NT887-7
1NT1-1	1NT1-7	2NT1-10	2NT1-7	4NT1-1A	61NT887-7-NH
1NT1-1A	1NT1-7-C	2NT1-10A	2NT1-70	4NT1-1E	61NT887-8
1NT1-1-C	1NT1-7-COMB	2NT1-10J	2NT1-70-C	4NT1-2	61NT91-2
1NT1-1L	1NT1-7E	2NT1-12	2NT1-70-TM	4NT1-3	62NT1-1
1NT1-1N	1NT1-7-JLG	2NT1-12-NH-ALT	2NT1-72	4NT1-3D	62NT1-1-NH
1NT1-1-NH	1NT1-7-NH	2NT1-1A	2NT1-7-COMB	4NT1-5	62NT1-2
1NT1-1-NH-ALT	1NT1-7-NH-ALT	2NT1-1-C	2NT1-7E	4NT1-50	62NT1-3
1NT1-1P	1NT1-7-SKY	2NT1-1E	2NT1-7-JLG	4NT1-6	62NT1-3-A04
1NT1-2	1NT1-7-TM	2NT1-1-JLG	2NT1-7-NH	4NT1-61	62NT1-3-NH
1NT1-21	1NT1-8	2NT1-1L	2NT1-7-NH-ALT	4NT1-7	62NT1-6
1NT1-21-JLG	1NT1-8-C	2NT1-1N	2NT1-8	4NT1-70	62NT1-7
1NT1-21-NH-ALT	1NT1-8F	2NT1-1-NH	2NT1-8-C	4NT1-72	62NT1-7-NH
1NT1-2-C	1NT1-8-NH	2NT1-1-NH-ALT	2NT1-8-COMB	4NT1-8	62NT1-8
1NT1-2D	1NT1-8-TM	2NT1-2	2NT1-8-NH	4NT207-1E	62NT1-8-NH
1NT1-2F	1NT20-7E	2NT1-21	2NT1-8-NH-ALT	4NT319-7-C08	62NT91-1
1NT1-2G	1NT20-7N	2NT1-21-JLG	2NT231-7	4NT91-1	62NT91-1-NH
1NT1-2-NH-ALT	1NT231-7	2NT1-2-C	2NT887-10	4NT91-3	
1NT1-3	1NT887-1	2NT1-2G	2NT889-70	4NT91-5	
1NT1-31	1NT887-2	2NT1-3	2NT91-1	4NT91-7	

Warranty. Honeywell warrants goods of its manufacture as being free of defective materials and faulty workmanship. Honeywell's standard product warranty applies unless agreed to otherwise by Honeywell in writing; please refer to your order acknowledgement or consult your local sales office for specific warranty details. If warranted goods are returned to Honeywell during the period of coverage, Honeywell will repair or replace, at its option, without charge those items it finds defective. **The foregoing is buyer's sole remedy and is in lieu of all warranties, expressed or implied, including those of merchantability and fitness for a particular purpose. In no event shall Honeywell be liable for consequential, special, or indirect damages.**

While we provide application assistance personally, through our literature and the Honeywell web site, it is up to the customer to determine the suitability of the product in the application.

Specifications may change without notice. The information we supply is believed to be accurate and reliable as of this printing. However, we assume no responsibility for its use.

Find out more

Honeywell serves its customers through a worldwide network of sales offices, representatives and distributors. For application assistance, current specifications, pricing or name of the nearest Authorized Distributor, contact your local sales office. To learn more about Honeywell's sensing and control products, call **+1-815-235-6847/1-800-537-6945**, visit **sensing.honeywell.com**, or e-mail inquiries to **info.sc@honeywell.com**

Sensing and Control
Honeywell
1985 Douglas Drive North
Golden Valley, MN 55422 USA
sensing.honeywell.com

WARNING

MISUSE OF DOCUMENTATION

- The information presented in this datasheet is for reference only. DO NOT USE this document as product installation information.
- Complete installation, operation and maintenance information is provided in the instructions supplied with each product.

Failure to comply with these instructions could result in death or serious injury.

WARNING

PERSONAL INJURY

DO NOT USE these products as safety or emergency stop devices or in any other application where failure of the product could result in personal injury.

Failure to comply with these instructions could result in death or serious injury.

Honeywell