

10 A - 410 V internally clamped IGBT

Features

- Low threshold voltage
- Low on-voltage drop
- Low gate charge
- High current capability
- High voltage clamping feature

Applications

- Automotive ignition

Description

This IGBT utilizes the advanced PowerMESH™ process resulting in an excellent trade-off between switching performance and low on-state behavior. The built in collector-gate Zener exhibits a very precise active clamping while the gate-emitter Zener supplies an ESD protection.

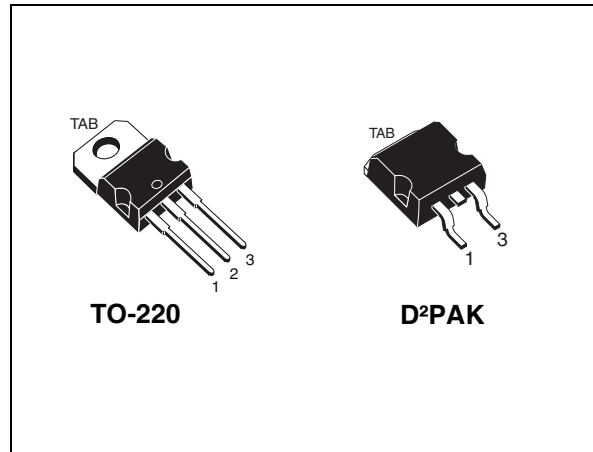

Figure 1. Internal schematic diagram

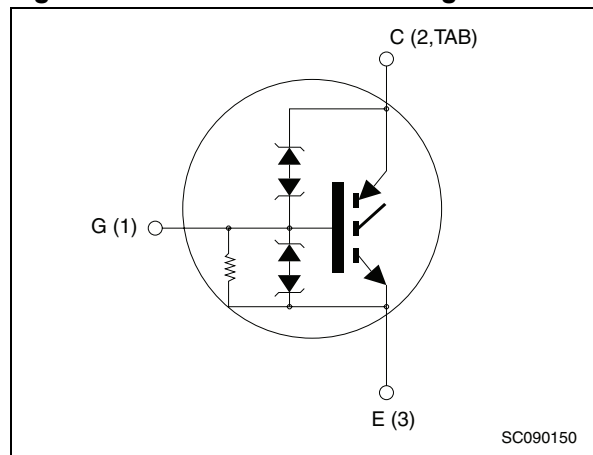

Table 1. Device summary

Order codes	Marking	Package	Packaging
STGB10NB37LZ	GB10NB37LZ	D ² PAK	Tube
STGB10NB37LZT4	GB10NB37LZ	D ² PAK	Tape and reel
STGP10NB37LZ	GP10NB37LZ	TO-220	Tube

Contents

1	Electrical ratings	3
2	Electrical characteristics	4
2.1	Electrical characteristics (curves)	6
3	Test circuits	9
4	Package mechanical data	10
5	Packaging mechanical data	13
6	Revision history	14

1 Electrical ratings

Table 2. Absolute maximum ratings

Symbol	Parameter	Value	Unit
V_{CES}	Collector-emitter voltage ($V_{GE} = 0$)	V_{CES} (clamped)	V
V_{ECS}	Emitter collector voltage ($V_{GE} = 0$)	18	V
$I_C^{(1)}$	Collector current (continuous) at $T_C = 25\text{ °C}$	20	A
$I_C^{(1)}$	Collector current (continuous) at $T_C = 100\text{ °C}$	10	A
$I_{CP}^{(2)}$	Pulsed collector current	40	A
$I_{CL}^{(3)}$	Turn-off latching current	40	A
V_{GE}	Gate-emitter voltage	V_{GE} (clamped)	V
P_{TOT}	Total dissipation at $T_C = 25\text{ °C}$	125	W
ESD(HBM)	Electrostatic sensitive discharge, human body model applied to all three pins ($C=100\text{ pF}$, $R=1.5\text{ k}\Omega$)	4	kV
E_{AS}	Single pulse energy at $T_C = 25\text{ °C}$	300	mJ
T_{stg}	Storage temperature	- 65 to 175	°C
T_j	Operating junction temperature		

1. Calculated according to the iterative formula:

$$I_C(T_C) = \frac{T_{j(max)} - T_C}{R_{thj-c} \times V_{CE(sat)(max)}(T_{j(max)}, I_C(T_C))}$$

- Pulse width limited by maximum junction temperature and turn-off within RBSOA
- $V_{clamp} = 328\text{ V}$, $T_C = 125\text{ °C}$, $R_G=1\text{ k}\Omega$, $V_{GE}=5\text{ V}$

Table 3. Thermal data

Symbol	Parameter	Value	Unit
$R_{thj-case}$	Thermal resistance junction-case	1.2	°C/W
$R_{thj-amb}$	Thermal resistance junction-ambient	62.5	°C/W

2 Electrical characteristics

($T_J = 25\text{ °C}$ unless otherwise specified)

Table 4. Static

Symbol	Parameter	Test conditions	Min.	Typ.	Max.	Unit
$V_{CES(\text{clamped})}$	Collector emitter clamped voltage ($V_{GE} = 0$)	$I_C = 2\text{ mA}$, $T_J = -40\text{ °C to }150\text{ °C}$	380	410	440	V
$V_{(BR)ECS}$	Emitter collector break-down voltage ($V_{GE} = 0$)	$I_{EC} = 75\text{ mA}$	18			V
$V_{GE(\text{clamped})}$	Gate emitter clamped voltage	$I_G = \pm 2\text{ mA}$	12		16	V
$V_{CE(\text{sat})}$	Collector-emitter saturation voltage	$V_{GE} = 4.5\text{ V}$, $I_C = 10\text{ A}$ $V_{GE} = 4.5\text{ V}$, $I_C = 20\text{ A}$		1.2 1.3	1.8	V V
$V_{GE(\text{th})}$	Gate threshold voltage	$V_{CE} = V_{GE}$, $I_C = 250\text{ }\mu\text{A}$ $T_J = -40\text{ °C to }150\text{ °C}$	0.6		2.2	V
I_{CES}	Collector cut-off current ($V_{GE} = 0$)	$V_{CE} = 15\text{ V}$, $T_J = 150\text{ °C}$ $V_{CE} = 200\text{ V}$, $T_J = 150\text{ °C}$			10 100	μA μA
I_{GES}	Gate-emitter leakage current ($V_{CE} = 0$)	$V_{GE} = \pm 10\text{ V}$			± 700	μA
R_{GE}	Gate emitter resistance			20		k Ω
g_{fs}	Forward transconductance	$V_{CE} = 25\text{ V}$, $I_C = 20\text{ A}$		18		S

Table 5. Dynamic

Symbol	Parameter	Test conditions	Min.	Typ.	Max.	Unit
C_{ies} C_{oes} C_{res}	Input capacitance Output capacitance Reverse transfer capacitance	$V_{CE} = 25\text{ V}$, $f = 1\text{ MHz}$, $V_{GE} = 0$		1300 105 12		pF pF pF
Q_g	Total gate charge	$V_{CE} = 328\text{ V}$, $I_C = 10\text{ A}$, $V_{GE} = 5\text{ V}$, (see Figure 18)		28		nC

Table 6. Functional characteristics

Symbol	Parameter	Test condition	Min.	Typ.	Max.	Unit
U.I.S.	Unclamped inductive switching current	$R_{G\text{OFF}} = 1\text{ k}\Omega$, $L = 1\text{ mH}$, $T_J = 125\text{ °C}$	13			A

Table 7. Switching on/off (inductive load)

Symbol	Parameter	Test conditions	Min.	Typ.	Max.	Unit
$t_{d(on)}$	Turn-on delay time	$V_{CC} = 328 \text{ V}$, $I_C = 10 \text{ A}$		1300		ns
t_r	Current rise time	$R_G = 1 \text{ k}\Omega$, $V_{GE} = 5 \text{ V}$		270		ns
$(di/dt)_{on}$	Turn-on current slope	(see Figure 19)		60		A/ μ s
t_c	Cross-over time	$V_{CC} = 328 \text{ V}$, $I_C = 10 \text{ A}$		3.6		μ s
$t_r(V_{off})$	Off voltage rise time	$R_G = 1 \text{ k}\Omega$, $V_{GE} = 5 \text{ V}$		2		μ s
$t_{d(off)}$	Delay time	(see Figure 19)		8		μ s
t_f	Fall time			1.4		μ s
t_c	Cross-over time	$V_{CC} = 328 \text{ V}$, $I_C = 10 \text{ A}$		5.7		μ s
$t_r(V_{off})$	Off voltage rise time	$R_G = 1 \text{ k}\Omega$, $V_{GE} = 5 \text{ V}$,		2.7		μ s
$t_{d(off)}$	Delay time	$T_J = 125 \text{ }^\circ\text{C}$		9.2		μ s
t_f	Fall time	(see Figure 19)		2.8		μ s

Table 8. Switching energy (inductive load)

Symbol	Parameter	Test conditions	Min.	Typ.	Max.	Unit
$E_{on}^{(1)}$	Turn-on switching losses	$V_{CC} = 328 \text{ V}$, $I_C = 10 \text{ A}$		2.4		mJ
$E_{off}^{(2)}$	Turn-off switching losses	$R_G = 1 \text{ k}\Omega$, $V_{GE} = 5 \text{ V}$		5		mJ
E_{ts}	Total switching losses	(see Figure 19)		7.4		mJ
$E_{on}^{(1)}$	Turn-on switching losses	$V_{CC} = 328 \text{ V}$, $I_C = 10 \text{ A}$		2.6		mJ
$E_{off}^{(2)}$	Turn-off switching losses	$R_G = 1 \text{ k}\Omega$, $V_{GE} = 5 \text{ V}$,		8.7		mJ
E_{ts}	Total switching losses	$T_J = 125 \text{ }^\circ\text{C}$ (see Figure 19)		11.3		mJ

1. E_{on} is the turn-on losses when a typical diode is used in the test circuit in figure 2. If the IGBT is offered in a package with a co-pack diode, the co-pack diode is used as external diode. IGBTs & Diode are at the same temperature (25 °C and 125 °C)
2. Turn-off losses include also the tail of the collector current

2.1 Electrical characteristics (curves)

Figure 2. Output characteristics

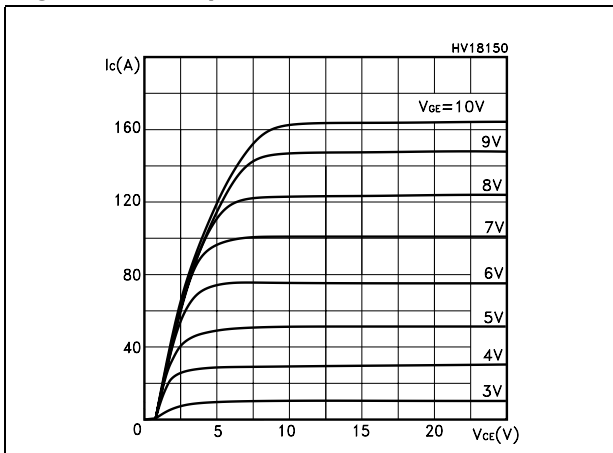

Figure 3. Transfer characteristics

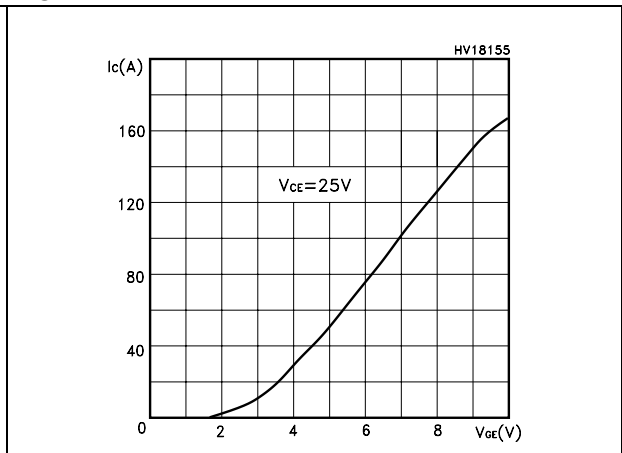

Figure 4. Transconductance

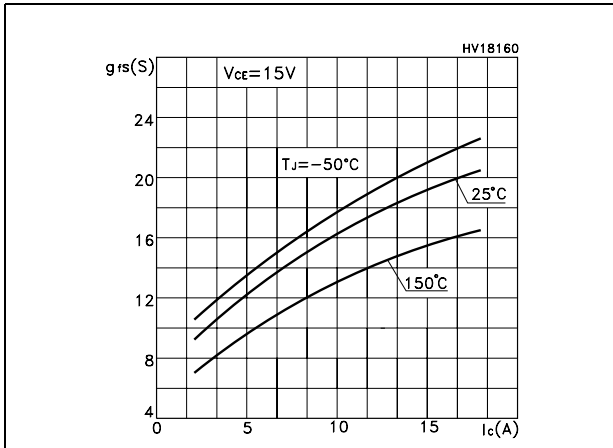

Figure 5. Collector-emitter on voltage vs temperature

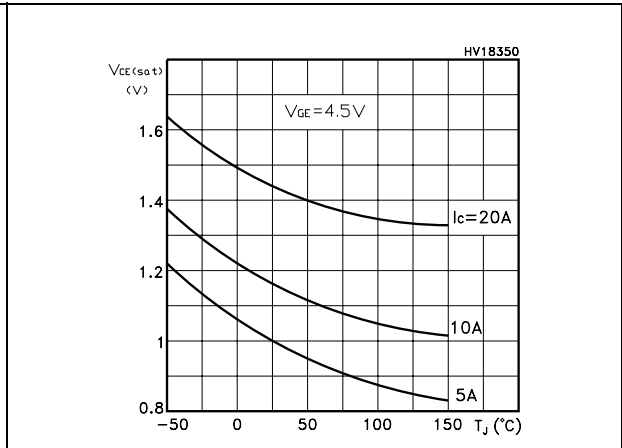

Figure 6. Gate charge vs gate-source voltage

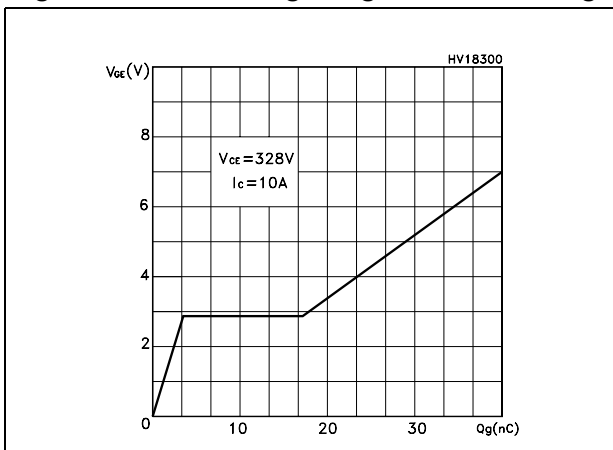

Figure 7. Capacitance variations

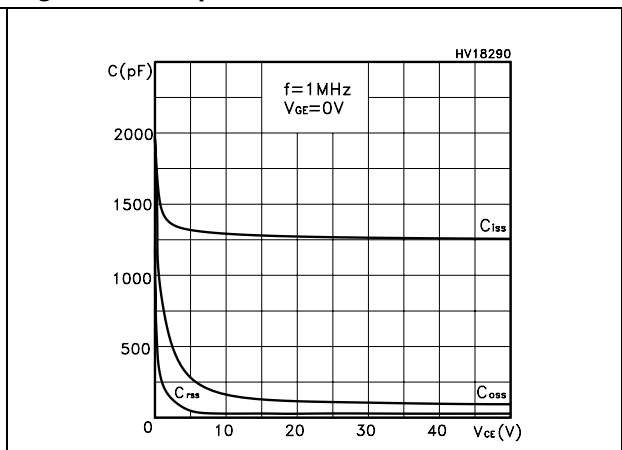

Figure 8. Normalized gate threshold voltage vs temperature

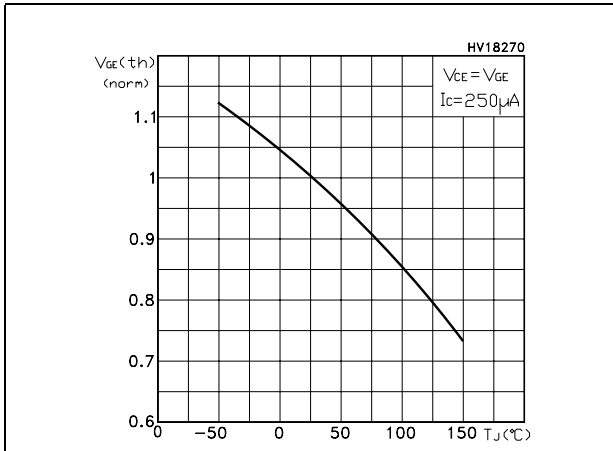

Figure 9. Collector-emitter on voltage vs collector current

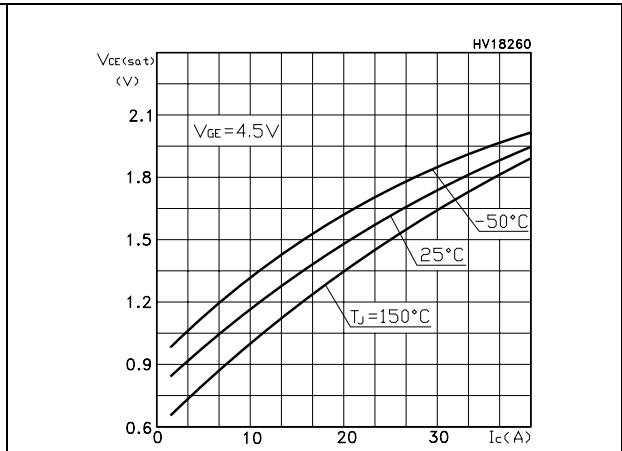

Figure 10. Normalized clamping voltage vs temperature

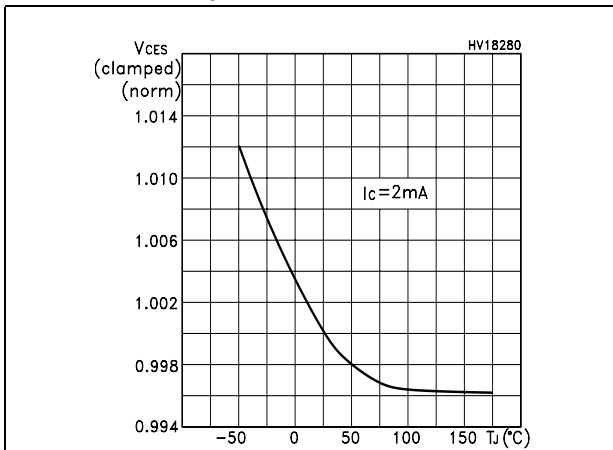

Figure 11. Switching losses vs temperature

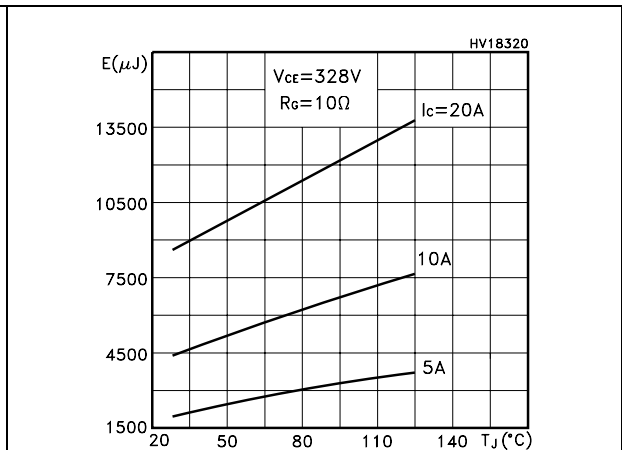

Figure 12. Switching losses vs gate resistance

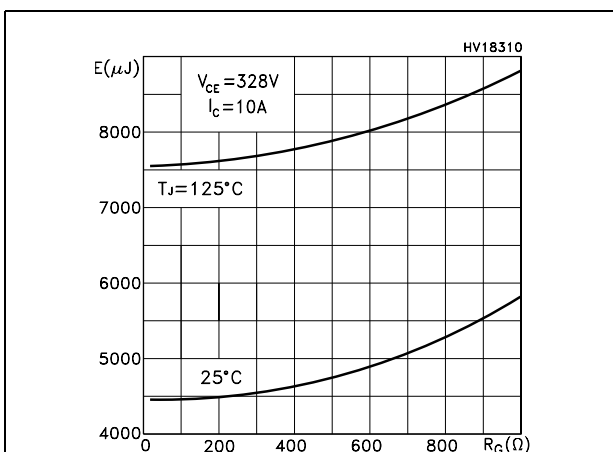

Figure 13. Switching losses vs collector current

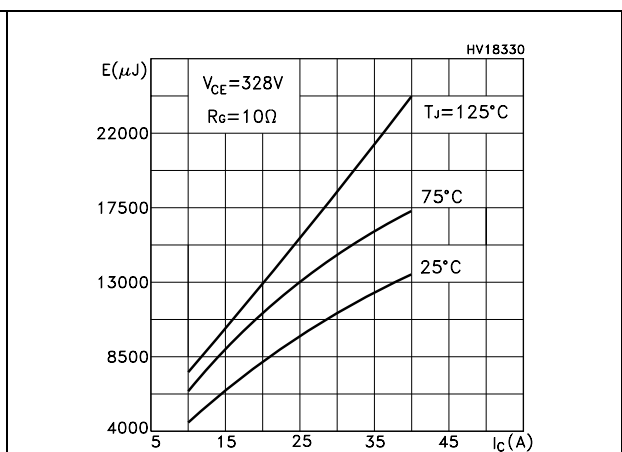

Figure 14. Thermal impedance

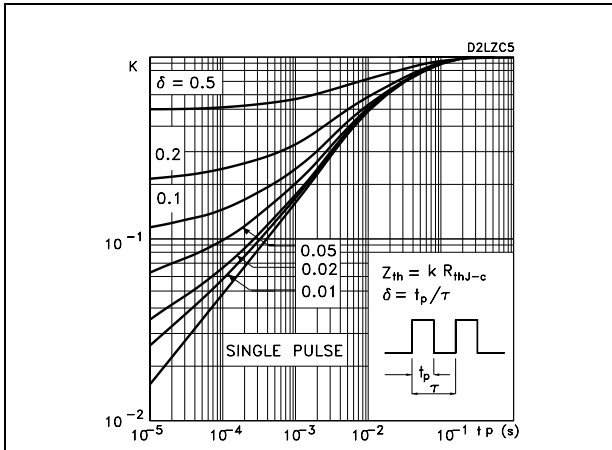

Figure 15. Turn-off SOA

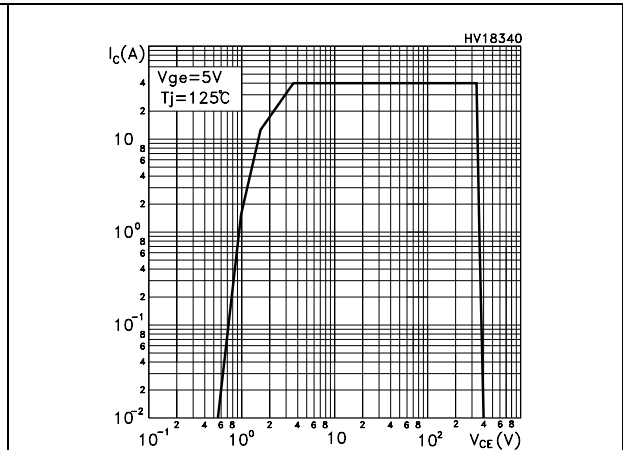
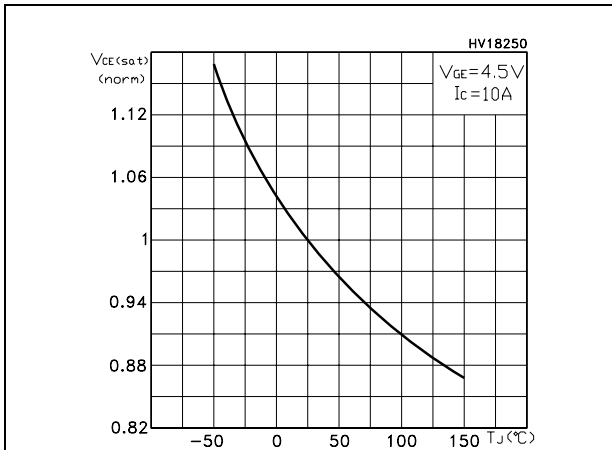
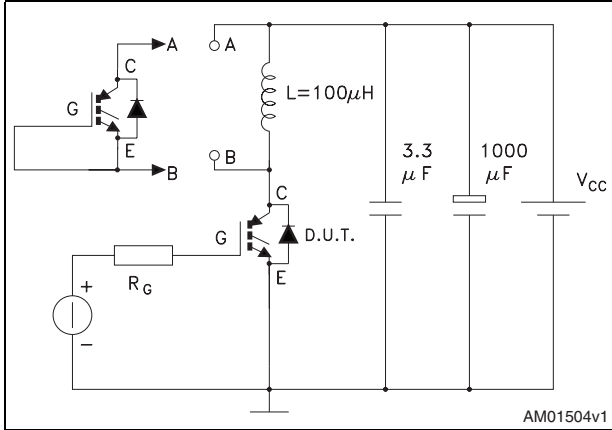

Figure 16. Normalized collector-emitter on voltage vs temperature



3 Test circuits

Figure 17. Test circuit for inductive load switching



AM01504v1

Figure 18. Gate charge test circuit

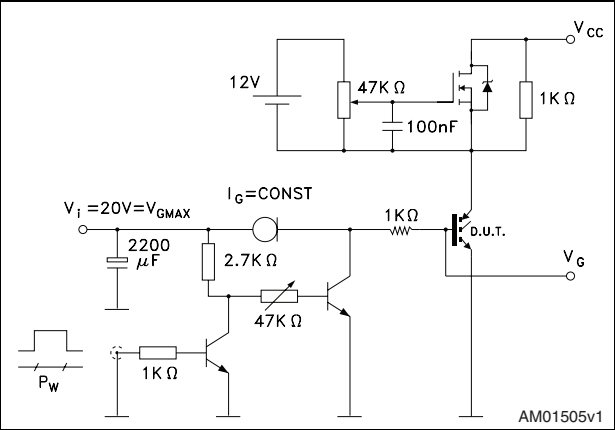

AM01505v1

Figure 19. Switching waveform

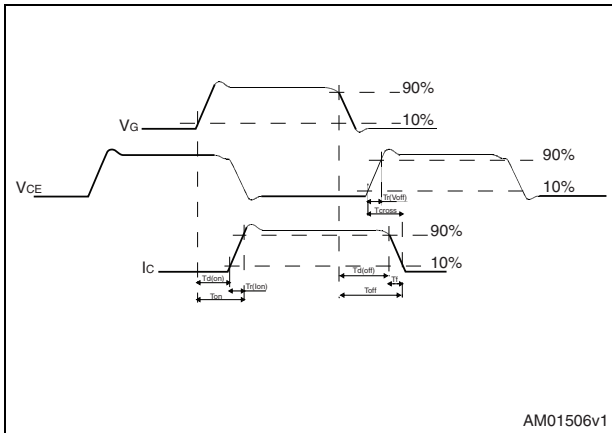

AM01506v1

4 Package mechanical data

In order to meet environmental requirements, ST offers these devices in different grades of ECOPACK® packages, depending on their level of environmental compliance. ECOPACK® specifications, grade definitions and product status are available at: www.st.com. ECOPACK is an ST trademark.

D²PAK (TO-263) mechanical data

Dim	mm			inch		
	Min	Typ	Max	Min	Typ	Max
A	4.40		4.60	0.173		0.181
A1	0.03		0.23	0.001		0.009
b	0.70		0.93	0.027		0.037
b2	1.14		1.70	0.045		0.067
c	0.45		0.60	0.017		0.024
c2	1.23		1.36	0.048		0.053
D	8.95		9.35	0.352		0.368
D1	7.50			0.295		
E	10		10.40	0.394		0.409
E1	8.50			0.334		
e		2.54			0.1	
e1	4.88		5.28	0.192		0.208
H	15		15.85	0.590		0.624
J1	2.49		2.69	0.099		0.106
L	2.29		2.79	0.090		0.110
L1	1.27		1.40	0.05		0.055
L2	1.30		1.75	0.051		0.069
R		0.4			0.016	
V2	0°		8°	0°		8°

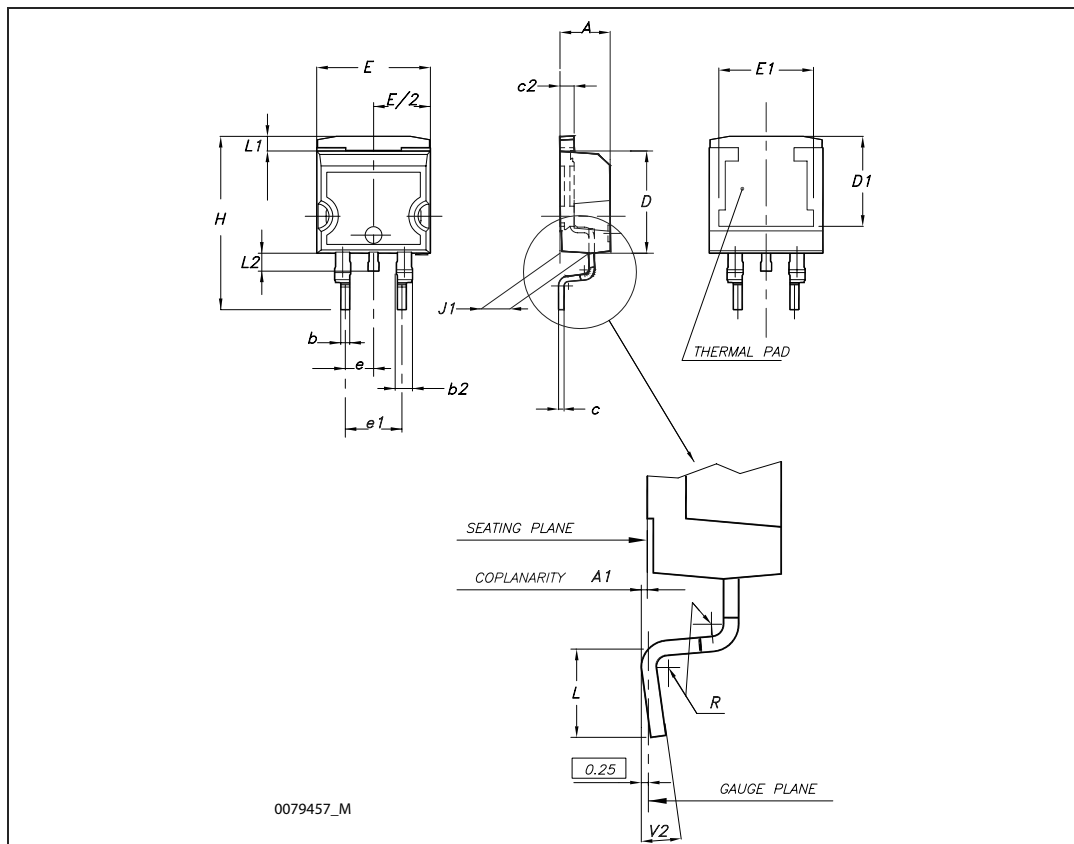

TO-220 type A mechanical data

Dim	mm		
	Min	Typ	Max
A	4.40		4.60
b	0.61		0.88
b1	1.14		1.70
c	0.48		0.70
D	15.25		15.75
D1		1.27	
E	10		10.40
e	2.40		2.70
e1	4.95		5.15
F	1.23		1.32
H1	6.20		6.60
J1	2.40		2.72
L	13		14
L1	3.50		3.93
L20		16.40	
L30		28.90	
∅P	3.75		3.85
Q	2.65		2.95

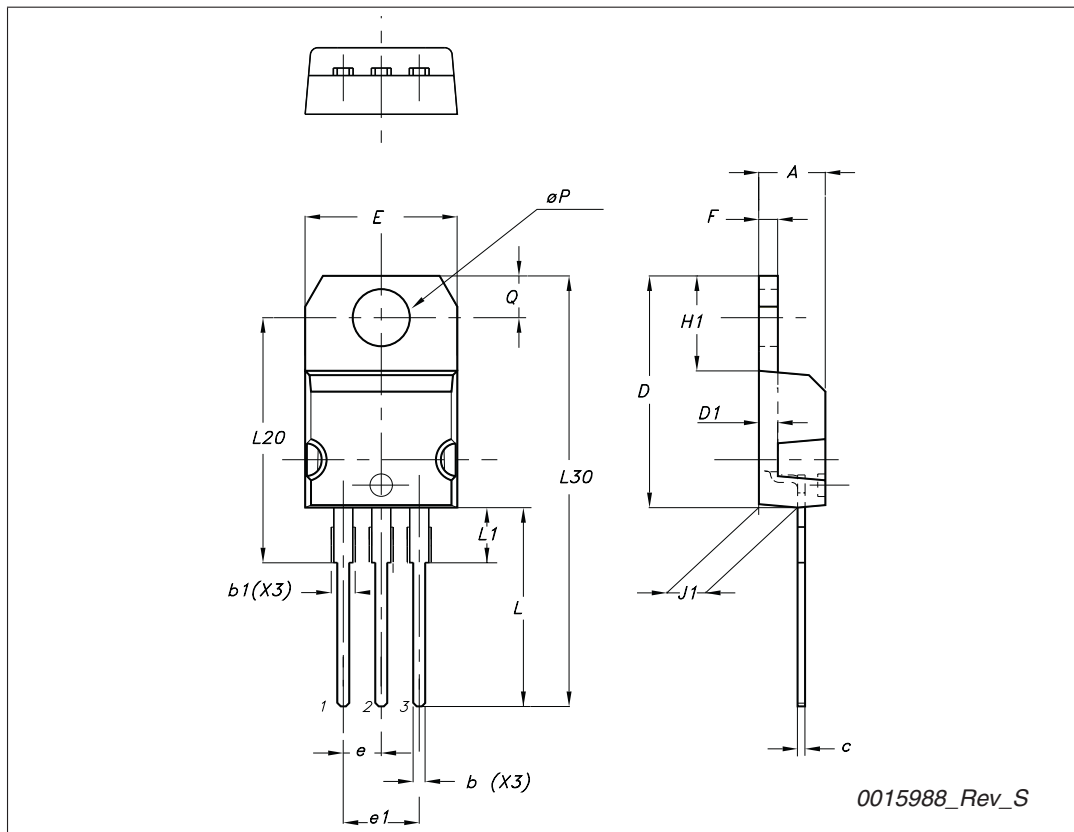

5 Packaging mechanical data

D²PAK FOOTPRINT

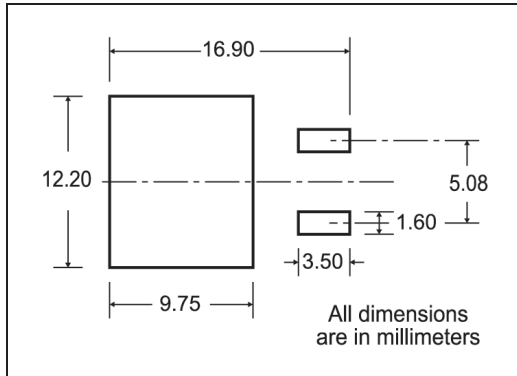

TAPE AND REEL SHIPMENT

40 mm min. Access hole at slot location

Full radius

Tape slot in core for tape start 2.5mm min. width

G measured at hub

REEL MECHANICAL DATA

DIM.	mm		inch	
	MIN.	MAX.	MIN.	MAX.
A		330		12.992
B	1.5		0.059	
C	12.8	13.2	0.504	0.520
D	20.2		0.795	
G	24.4	26.4	0.960	1.039
N	100		3.937	
T		30.4		1.197

BASE QTY	BULK QTY
1000	1000

TAPE MECHANICAL DATA

DIM.	mm		inch	
	MIN.	MAX.	MIN.	MAX.
A0	10.5	10.7	0.413	0.421
B0	15.7	15.9	0.618	0.626
D	1.5	1.6	0.059	0.063
D1	1.59	1.61	0.062	0.063
E	1.65	1.85	0.065	0.073
F	11.4	11.6	0.449	0.456
K0	4.8	5.0	0.189	0.197
P0	3.9	4.1	0.153	0.161
P1	11.9	12.1	0.468	0.476
P2	1.9	2.1	0.075	0.082
R	50		1.574	
T	0.25	0.35	0.0098	0.0137
W	23.7	24.3	0.933	0.956

10 pitches cumulative tolerance on tape + / - 0.2 mm

Center line of cavity

User Direction of Feed

FEED DIRECTION

TRL

Bending radius

R min.

6 Revision history

Table 9. Document revision history

Date	Revision	Changes
23-Jan-2006	2	
11-Feb-2009	3	Added new package, mechanical data TO-220
06-Nov-2009	4	TO-220 mechanical data has been updated.

Please Read Carefully:

Information in this document is provided solely in connection with ST products. STMicroelectronics NV and its subsidiaries ("ST") reserve the right to make changes, corrections, modifications or improvements, to this document, and the products and services described herein at any time, without notice.

All ST products are sold pursuant to ST's terms and conditions of sale.

Purchasers are solely responsible for the choice, selection and use of the ST products and services described herein, and ST assumes no liability whatsoever relating to the choice, selection or use of the ST products and services described herein.

No license, express or implied, by estoppel or otherwise, to any intellectual property rights is granted under this document. If any part of this document refers to any third party products or services it shall not be deemed a license grant by ST for the use of such third party products or services, or any intellectual property contained therein or considered as a warranty covering the use in any manner whatsoever of such third party products or services or any intellectual property contained therein.

UNLESS OTHERWISE SET FORTH IN ST'S TERMS AND CONDITIONS OF SALE ST DISCLAIMS ANY EXPRESS OR IMPLIED WARRANTY WITH RESPECT TO THE USE AND/OR SALE OF ST PRODUCTS INCLUDING WITHOUT LIMITATION IMPLIED WARRANTIES OF MERCHANTABILITY, FITNESS FOR A PARTICULAR PURPOSE (AND THEIR EQUIVALENTS UNDER THE LAWS OF ANY JURISDICTION), OR INFRINGEMENT OF ANY PATENT, COPYRIGHT OR OTHER INTELLECTUAL PROPERTY RIGHT.

UNLESS EXPRESSLY APPROVED IN WRITING BY AN AUTHORIZED ST REPRESENTATIVE, ST PRODUCTS ARE NOT RECOMMENDED, AUTHORIZED OR WARRANTED FOR USE IN MILITARY, AIR CRAFT, SPACE, LIFE SAVING, OR LIFE SUSTAINING APPLICATIONS, NOR IN PRODUCTS OR SYSTEMS WHERE FAILURE OR MALFUNCTION MAY RESULT IN PERSONAL INJURY, DEATH, OR SEVERE PROPERTY OR ENVIRONMENTAL DAMAGE. ST PRODUCTS WHICH ARE NOT SPECIFIED AS "AUTOMOTIVE GRADE" MAY ONLY BE USED IN AUTOMOTIVE APPLICATIONS AT USER'S OWN RISK.

Resale of ST products with provisions different from the statements and/or technical features set forth in this document shall immediately void any warranty granted by ST for the ST product or service described herein and shall not create or extend in any manner whatsoever, any liability of ST.

ST and the ST logo are trademarks or registered trademarks of ST in various countries.

Information in this document supersedes and replaces all information previously supplied.

The ST logo is a registered trademark of STMicroelectronics. All other names are the property of their respective owners.

© 2009 STMicroelectronics - All rights reserved

STMicroelectronics group of companies

Australia - Belgium - Brazil - Canada - China - Czech Republic - Finland - France - Germany - Hong Kong - India - Israel - Italy - Japan - Malaysia - Malta - Morocco - Philippines - Singapore - Spain - Sweden - Switzerland - United Kingdom - United States of America

www.st.com

