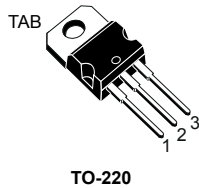
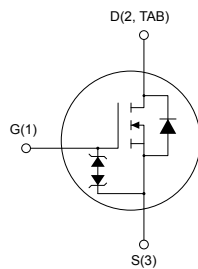


# N-channel 600 V, 0.260 $\Omega$ typ., 12 A MDmesh DM2 Power MOSFET in a TO-220 package


**TO-220**


AM01475V1


**Product status links**
[STP18N60DM2](#)
**Product summary**

<b>Order code</b>	STP18N60DM2
<b>Marking</b>	18N60DM2
<b>Package</b>	TO-220
<b>Packing</b>	Tube

## Features

Order code	$V_{DS}$	$R_{DS(on)}$ max.	$I_D$
STP18N60DM2	600 V	0.295 $\Omega$	12 A

- Fast-recovery body diode
- Extremely low gate charge and input capacitance
- Low on-resistance
- 100% avalanche tested
- Extremely high dv/dt ruggedness
- Zener-protected

## Applications

- Switching applications

## Description

This high-voltage N-channel Power MOSFET is part of the MDmesh DM2 fast-recovery diode series. It offers very low recovery charge ( $Q_{rr}$ ) and time ( $t_{rr}$ ) combined with low  $R_{DS(on)}$ , rendering it suitable for the most demanding high-efficiency converters and ideal for bridge topologies and ZVS phase-shift converters.

# 1 Electrical ratings

**Table 1. Absolute maximum ratings**

Symbol	Parameter	Value	Unit
$V_{GS}$	Gate-source voltage	±25	V
$I_D$	Drain current (continuous) at $T_{case} = 25\text{ °C}$	12	A
$I_D$	Drain current (continuous) at $T_{case} = 100\text{ °C}$	7.6	A
$I_{DM}^{(1)}$	Drain current (pulsed)	48	A
$P_{TOT}$	Total power dissipation at $T_{case} = 25\text{ °C}$	110	W
$dv/dt^{(2)}$	Peak diode recovery voltage slope	40	V/ns
$dv/dt^{(3)}$	MOSFET $dv/dt$ ruggedness	50	
$T_{stg}$	Storage temperature range	-55 to 150	°C
$T_j$	Operating junction temperature range		°C

1. Pulse width is limited by safe operating area.
2.  $I_{SD} \leq 12$ ,  $di/dt \leq 400\text{ A}/\mu\text{s}$ ,  $V_{DS(peak)} < V_{(BR)DSS}$ ,  $V_{DD} = 400\text{ V}$
3.  $V_{DS} \leq 480\text{ V}$

**Table 2. Thermal data**

Symbol	Parameter	Value	Unit
$R_{thj-case}$	Thermal resistance junction-case	1.14	°C/W
$R_{thj-amb}$	Thermal resistance junction-ambient	62.5	

**Table 3. Avalanche characteristics**

Symbol	Parameter	Value	Unit
$I_{AR}$	Avalanche current, repetitive or not repetitive (pulse width limited by $T_{jmax}$ )	2.5	A
$E_{AR}$	Single pulse avalanche energy (starting $T_j = 25\text{ °C}$ , $I_D = I_{AR}$ , $V_{DD} = 50\text{ V}$ )	380	mJ

## 2 Electrical characteristics

( $T_{case} = 25\text{ °C}$  unless otherwise specified)

**Table 4. Static**

Symbol	Parameter	Test conditions	Min.	Typ.	Max.	Unit
$V_{(BR)DSS}$	Drain-source breakdown voltage	$V_{GS} = 0\text{ V}$ , $I_D = 1\text{ mA}$	600			V
$I_{DSS}$	Zero gate voltage drain current	$V_{GS} = 0\text{ V}$ , $V_{DS} = 600\text{ V}$			1	$\mu\text{A}$
		$V_{GS} = 0\text{ V}$ , $V_{DS} = 600\text{ V}$ , $T_{case} = 125\text{ °C}$ <sup>(1)</sup>			100	$\mu\text{A}$
$I_{GSS}$	Gate-body leakage current	$V_{DS} = 0\text{ V}$ , $V_{GS} = \pm 25\text{ V}$			$\pm 5$	$\mu\text{A}$
$V_{GS(th)}$	Gate threshold voltage	$V_{DS} = V_{GS}$ , $I_D = 250\text{ }\mu\text{A}$	3	4	5	V
$R_{DS(on)}$	Static drain-source on-resistance	$V_{GS} = 10\text{ V}$ , $I_D = 6\text{ A}$		0.260	0.295	$\Omega$

1. Defined by design, not subject to production test.

**Table 5. Dynamic**

Symbol	Parameter	Test conditions	Min.	Typ.	Max.	Unit
$C_{iss}$	Input capacitance	$V_{DS} = 100\text{ V}$ , $f = 1\text{ MHz}$ , $V_{GS} = 0\text{ V}$	-	800	-	pF
$C_{oss}$	Output capacitance		-	40	-	pF
$C_{rSS}$	Reverse transfer capacitance		-	1.33	-	pF
$C_{oss\ eq.}^{(1)}$	Equivalent output capacitance	$V_{DS} = 0$ to $480\text{ V}$ , $f = 1\text{ MHz}$ , $V_{GS} = 0\text{ V}$	-	80	-	pF
$R_G$	Intrinsic gate resistance	$f = 1\text{ MHz}$ , $I_D = 0\text{ A}$	-	5.6	-	$\Omega$
$Q_g$	Total gate charge	$V_{DD} = 480\text{ V}$ , $I_D = 12\text{ A}$ , $V_{GS} = 0$ to $10\text{ V}$ (see Figure 14. Test circuit for gate charge behavior)	-	20	-	nC
$Q_{gs}$	Gate-source charge		-	5.2	-	nC
$Q_{gd}$	Gate-drain charge		-	8.5	-	nC

1.  $C_{oss\ eq.}$  is defined as a constant equivalent capacitance giving the same charging time as  $C_{oss}$  when  $V_{DS}$  increases from 0 to 80%  $V_{DSS}$

**Table 6. Switching times**

Symbol	Parameter	Test conditions	Min.	Typ.	Max.	Unit
$t_{d(on)}$	Turn-on delay time	$V_{DD} = 300\text{ V}$ , $I_D = 6\text{ A}$ , $R_G = 4.7\text{ }\Omega$ , $V_{GS} = 10\text{ V}$ (see Figure 13. Test circuit for resistive load switching times and Figure 18. Switching time waveform)	-	13.5	-	ns
$t_r$	Rise time		-	8	-	ns
$t_{d(off)}$	Turn-off delay time		-	9.5	-	ns
$t_f$	Fall time		-	32.5	-	ns

**Table 7. Source-drain diode**

Symbol	Parameter	Test conditions	Min.	Typ.	Max.	Unit
$I_{SD}$	Source-drain current		-		12	A
$I_{SDM}^{(1)}$	Source-drain current (pulsed)		-		48	A
$V_{SD}^{(2)}$	Forward on voltage	$V_{GS} = 0\text{ V}$ , $I_{SD} = 12\text{ A}$	-		1.6	V
$t_{rr}$	Reverse recovery time	$I_{SD} = 12\text{ A}$ , $di/dt = 100\text{ A}/\mu\text{s}$ , $V_{DD} = 60\text{ V}$ (see Figure 15. Test circuit for inductive load switching and diode recovery times)	-	125		ns
$Q_{rr}$	Reverse recovery charge		-	0.675		$\mu\text{C}$
$I_{RRM}$	Reverse recovery current		-	11		A
$t_{rr}$	Reverse recovery time	$I_{SD} = 12\text{ A}$ , $di/dt = 100\text{ A}/\mu\text{s}$ , $V_{DD} = 60\text{ V}$ , $T_j = 150\text{ }^\circ\text{C}$ (see Figure 15. Test circuit for inductive load switching and diode recovery times)	-	190		ns
$Q_{rr}$	Reverse recovery charge		-	1.225		$\mu\text{C}$
$I_{RRM}$	Reverse recovery current		-	13		A

1. Pulse width is limited by safe operating area.
2. Pulse test: pulse duration = 300  $\mu\text{s}$ , duty cycle 1.5%.

## 2.1 Electrical characteristics (curves)

Figure 1. Safe operating area

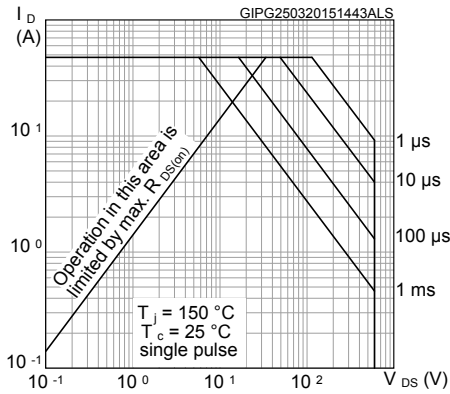


Figure 2. Thermal impedance

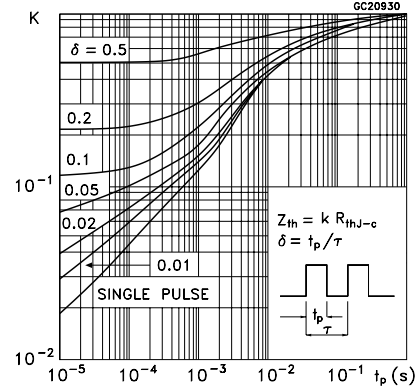


Figure 3. Output characteristics

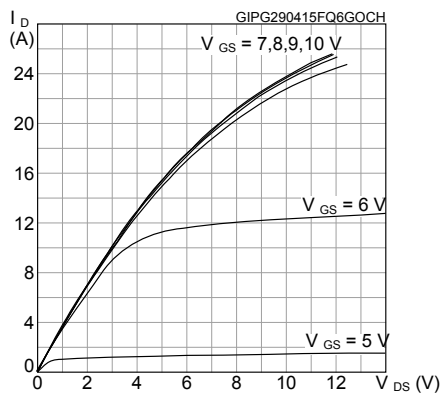


Figure 4. Transfer characteristics

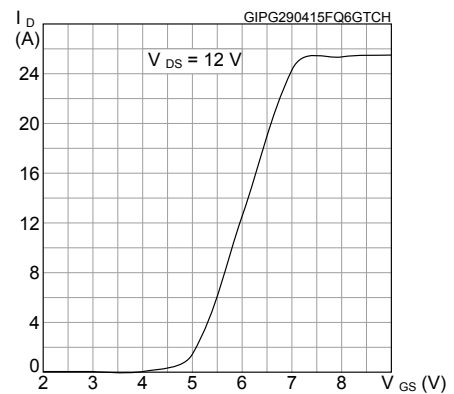


Figure 5. Gate charge vs gate-source voltage

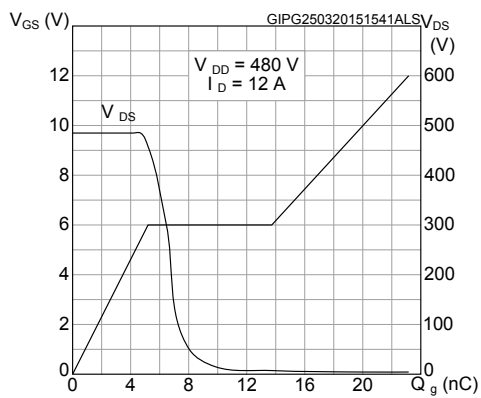
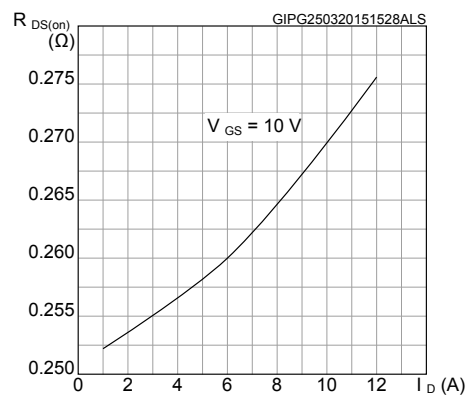
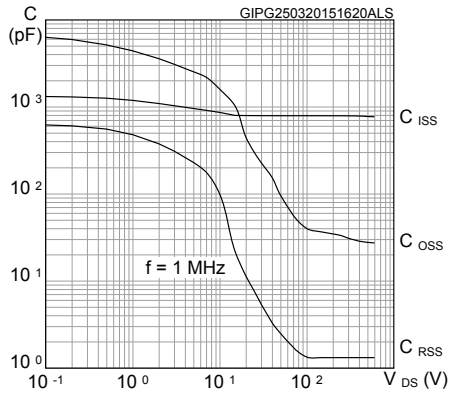


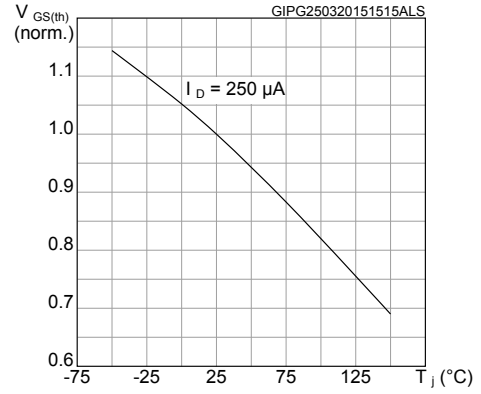
Figure 6. Static drain-source on-resistance



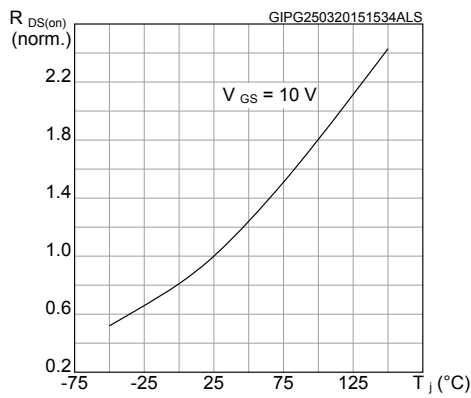
**Figure 7. Capacitance variations**



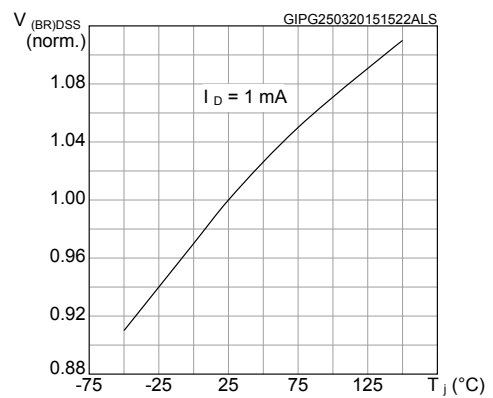
**Figure 8. Normalized gate threshold voltage vs temperature**



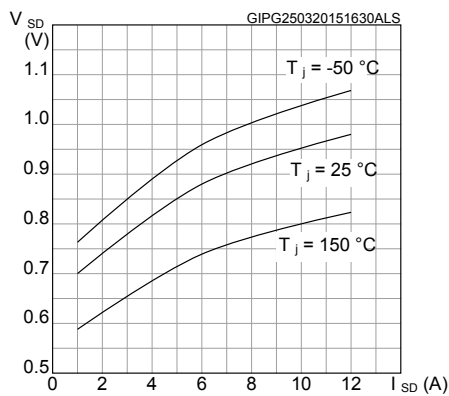
**Figure 9. Normalized on-resistance vs temperature**



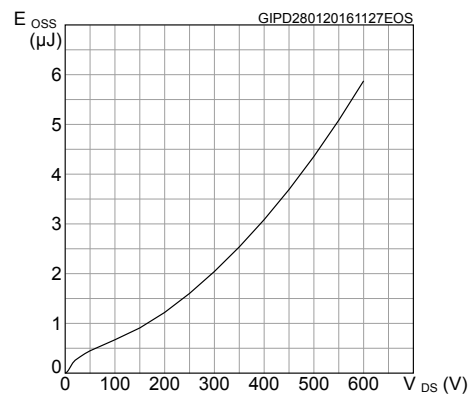
**Figure 10. Normalized V\_(BR)DSS vs temperature**



**Figure 11. Source-drain diode forward characteristics**

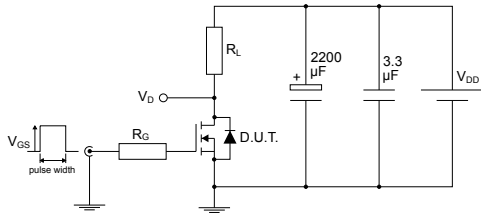


**Figure 12. Output capacitance stored energy**



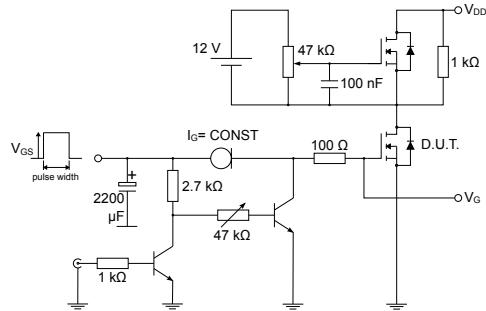
### 3 Test circuits

Figure 13. Test circuit for resistive load switching times



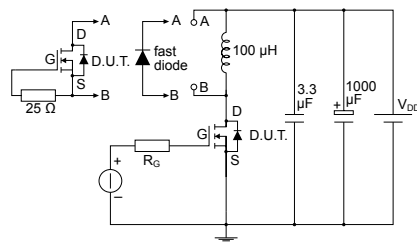
AM01468v1

Figure 14. Test circuit for gate charge behavior



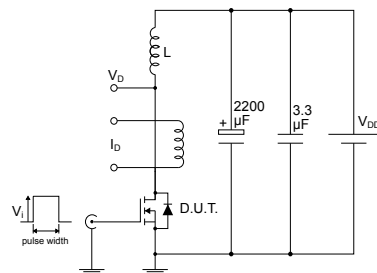
AM01469v1

Figure 15. Test circuit for inductive load switching and diode recovery times



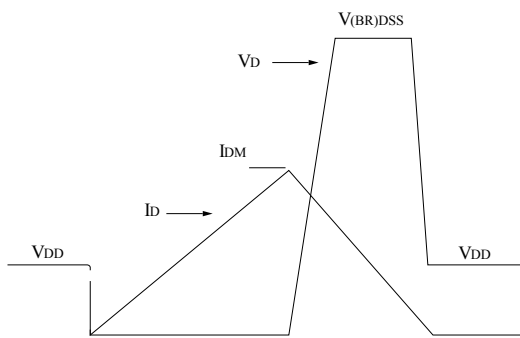
AM01470v1

Figure 16. Unclamped inductive load test circuit



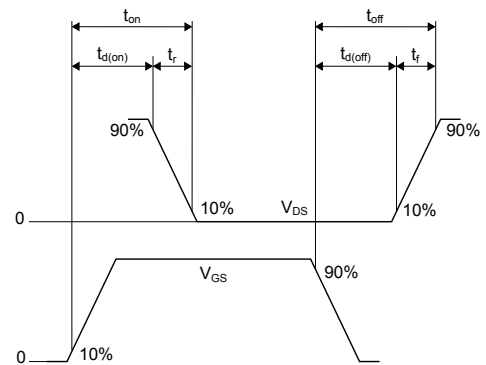
AM01471v1

Figure 17. Unclamped inductive waveform



AM01472v1

Figure 18. Switching time waveform



AM01473v1

## 4 Package information

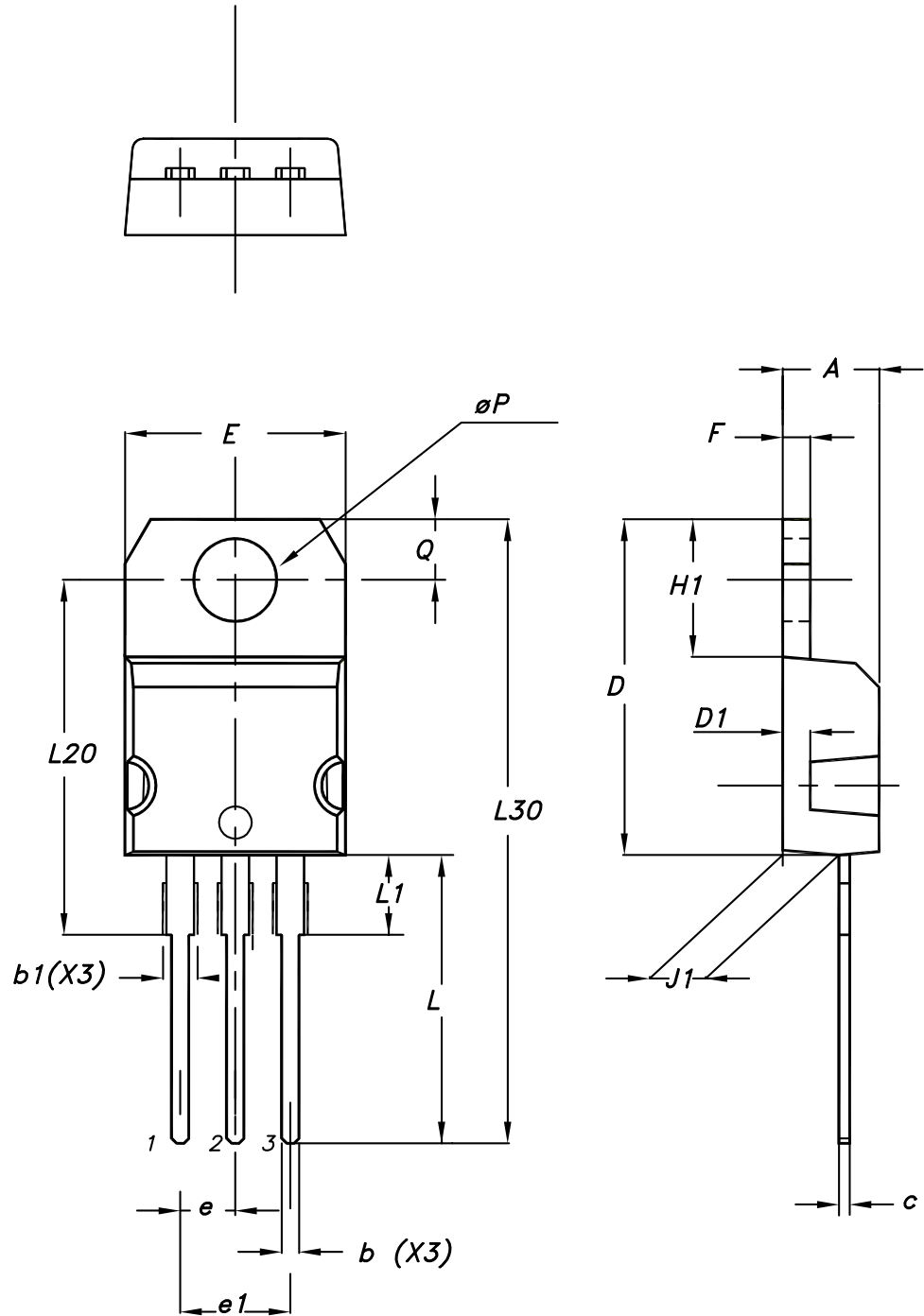
---

In order to meet environmental requirements, ST offers these devices in different grades of **ECOPACK** packages, depending on their level of environmental compliance. ECOPACK specifications, grade definitions and product status are available at: [www.st.com](http://www.st.com). ECOPACK is an ST trademark.



#### 4.1 TO-220 type A package information

Figure 19. TO-220 type A package outline



0015988\_typeA\_Rev\_22

**Table 8. TO-220 type A package mechanical data**

Dim.	mm		
	Min.	Typ.	Max.
A	4.40		4.60
b	0.61		0.88
b1	1.14		1.55
c	0.48		0.70
D	15.25		15.75
D1		1.27	
E	10.00		10.40
e	2.40		2.70
e1	4.95		5.15
F	1.23		1.32
H1	6.20		6.60
J1	2.40		2.72
L	13.00		14.00
L1	3.50		3.93
L20		16.40	
L30		28.90	
øP	3.75		3.85
Q	2.65		2.95

## Revision history

**Table 9. Document revision history**

Date	Revision	Changes
01-Apr-2015	1	First release.
21-May-2015	2	Text edits throughout document In <i>Section 2.1 Electrical characteristics (curves)</i> : - updated <i>Figure 4: Output characteristics</i> - updated <i>Figure 5: Transfer characteristics</i>
28-Jan-2016	3	Updated <i>Section 2.1: "Electrical characteristics (curves)"</i>
13-Sep-2016	4	Updated title in cover page.
10-Jun-2019	5	Modified Table 1, Table 2, <a href="#">Table 4. Static</a> and <a href="#">Table 7. Source-drain diode</a> . Minor text changes.

---

## Contents

<b>1</b>	<b>Electrical ratings</b> .....	<b>2</b>
<b>2</b>	<b>Electrical characteristics</b> .....	<b>3</b>
<b>2.1</b>	<b>Electrical characteristics (curves)</b> .....	<b>5</b>
<b>3</b>	<b>Test circuits</b> .....	<b>7</b>
<b>4</b>	<b>Package information</b> .....	<b>8</b>
<b>4.1</b>	<b>TO-220 type A package information</b> .....	<b>8</b>
	<b>Revision history</b> .....	<b>11</b>

**IMPORTANT NOTICE – PLEASE READ CAREFULLY**

STMicroelectronics NV and its subsidiaries (“ST”) reserve the right to make changes, corrections, enhancements, modifications, and improvements to ST products and/or to this document at any time without notice. Purchasers should obtain the latest relevant information on ST products before placing orders. ST products are sold pursuant to ST’s terms and conditions of sale in place at the time of order acknowledgement.

Purchasers are solely responsible for the choice, selection, and use of ST products and ST assumes no liability for application assistance or the design of Purchasers’ products.

No license, express or implied, to any intellectual property right is granted by ST herein.

Resale of ST products with provisions different from the information set forth herein shall void any warranty granted by ST for such product.

ST and the ST logo are trademarks of ST. For additional information about ST trademarks, please refer to [www.st.com/trademarks](http://www.st.com/trademarks). All other product or service names are the property of their respective owners.

Information in this document supersedes and replaces information previously supplied in any prior versions of this document.

© 2019 STMicroelectronics – All rights reserved

# Mouser Electronics

Authorized Distributor

Click to View Pricing, Inventory, Delivery & Lifecycle Information:

[STMicroelectronics:](#)

[STP18N60DM2](#)