



# **Film capacitors – High Power Capacitors**

## **ModCap™ - Plastic Case Modular Series**

Date: September, 2020  
Edition: 1st

### Construction

- Dielectric: Polypropylene film
- Non PCB, PU Resin (UL 94 V-0 , Fire&Smoke EN 45545-2 HL2 R22-HL3R23)
- Plastic case and cover (UL 94 V-0, Fire&Smoke EN 45545-2HL2 R22-HL3R23)

### Features

- Modular design
- Self-healing technology
- Over-voltage capability

### Typical applications

- DC-link for renewable energy converters (Solar, wind).
- DC-link for traction applications (Locomotive, tramway, metro, light train inverters).
- DC-link for industrial motor drive

### Terminals

- Optimized low inductance flat female terminals M6.

### Technical data and specifications

Characteristics	
Rated capacitance $C_N$	Up to 3900 $\mu$ F ( see table )
Tolerance	K ( $\pm$ 10%), other tolerances available up on request.
Rated voltage range $U_N$	1100 to 2300V (see table)
Operation bandwidth (*)	Up to 50KHz
Rated current $I_R$ (1 kHz)	(see table)
Inductance $L_e$	Ca. 14 nH
$R_{th}$ (**)	Construction A: 1.4 K/W Construction B: 2 K/W

(\*) RMS current value that corresponds to components above 50kHz limited to 10% of total RMS. Maximum continuous losses defined for rated current at 1kHz should not be exceed. ESR vs frequency graphs available in page 5 for losses calculation according to a specific current spectrum. For more accurate thermal calculation, please ask for FEA simulation according to your specific operation conditions.

(\*\*) Calculated from  $T_{amb}$  to  $T_{hot-Spot}$  considering natural convection and no transfer of heat through the terminals. For more accurate thermal calculation, please ask for FEA simulation according to your specific operation conditions.

**Maximum ratings**

Maximum permissible voltage ( $U_{max}$ )	$U_N +10%$ (30 % of on-load daily duration) $U_N +15%$ (up to 30 min daily) $U_N +20%$ (up to 5 min daily) $U_N +30%$ (up to 1 min daily)
Maximum permissible peak voltage	$U_N +50%$ for 30 ms is permitted 1 000 times during the life of the capacitor
$U_{TC}$ (Isolation)	5 KV
$U_{TC}$ (Extinction)	3 KV (<10pC)

The average applied voltage shall not be higher than the specified voltage.

It should be recognised that any significant period of operation at voltages above the rated one would reduce overall life.

**Test data**

Voltage Test between terminals ( $U_{TT}$ )	$1.5 \cdot U_N$ , DC, 10s (Room temperature).
---	---

**Design data**

Weight approx.	3,7 Kg (Construction A) , 6,1 Kg (Construction B)
Filling	Non PCB, PU Resin
Fixing	4 x Ø6,5mm

**Climatic category 40/75/56**

$\ominus$ min	-40 °C
$\ominus$ max	75 °C
Storage temperature	-40 °C.....+85 °C
$\Theta_{hotspot}$ Max.	+90°C
Humidity	av. rel. < 93% 25 g/m <sup>3</sup> max
Time test	56 days
Maximum altitude	2,000 m Higher altitude to be requested.

**Life expectancy**

Lifetime (*)	Up to 200000 hours
End of life criteria	C-loss: 3%

(\*)  $U_n$ ,  $I_n$  and 70°C  $T_{amb}$  (80°C mean dielectric temperature)

**Terminals**

Terminations	4 x M6 x 25x 30mm, Contact area 60 mm <sup>2</sup>
Max. torque	6 Nm

**Reference standards**

IEC 61071	(International Standard Capacitors for power electronics)
IEC 61881-1	(International Standard Railway applications-Rolling stock equipment-Capacitors for power electronics)
EN 45545-2	(Railway applications-Fire protection on railway vehicles)

**Table of values**

$V_N$ (V)	Cap ( $\mu$ F)	$I_N$ (A)	$I_s$ (kA)	$\hat{I}$ (kA)	Dimensions (LxWxH, mm)	Construction	Part Number
1100	1395	180	215	5	243x169,5x90	A	B25645A1138K003
	2525	140	240	5	258x215x115	B	B25645A1258K003
1250	1100	170	210	5	243x169,5x90	A	B25645A1118K003
	1985	135	235	5	258x215x115	B	B25645A1198K003
1350	1025	160	205	5	243x169,5x90	A	B25645A1108K013
	1865	130	230	5	258x215x115	B	B25645A1188K003
1600	755	150	200	5	243x169,5x90	A	B25645A1757K003
	1375	120	225	5	258x215x115	B	B25645A1138K013
1800	560	140	195	5	243x169,5x90	A	B25645A1567K003
	1025	115	220	5	258x215x115	B	B25645A1108K003
2000	445	130	185	5	243x169,5x90	A	B25645A2447K003
	820	110	210	5	258x215x115	B	B25645A2827K003
2300	365	120	175	5	243x169,5x90	A	B25645A2367K003
	670	105	200	5	258x215x115	B	B25645A2677K003

$V_N$ : Nominal Voltage

**Cap**: tolerance +/-10%

$I_N$ : Nominal Current

$I_s$ : Surge Current

$\hat{I}$ : Repetitive Peak Current

\*: Preliminary part number, only available for samples

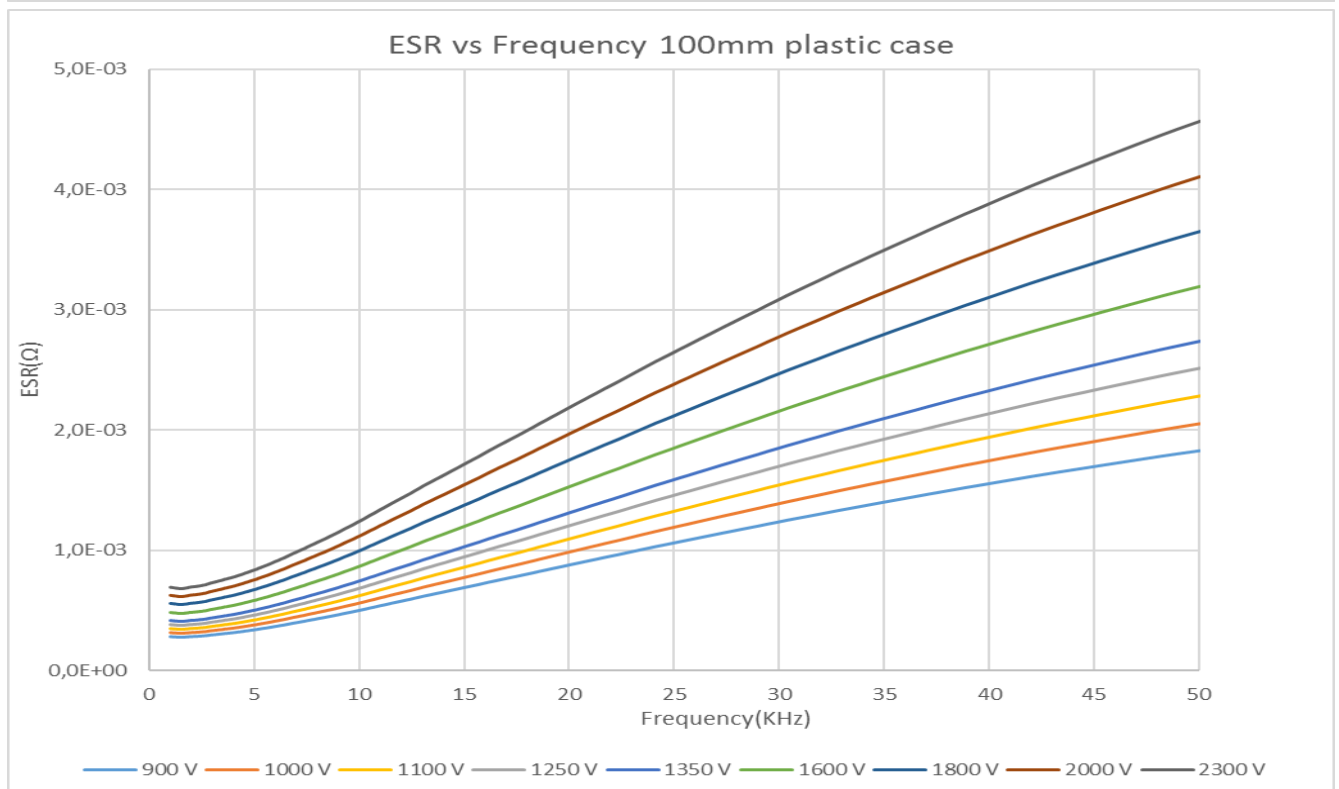
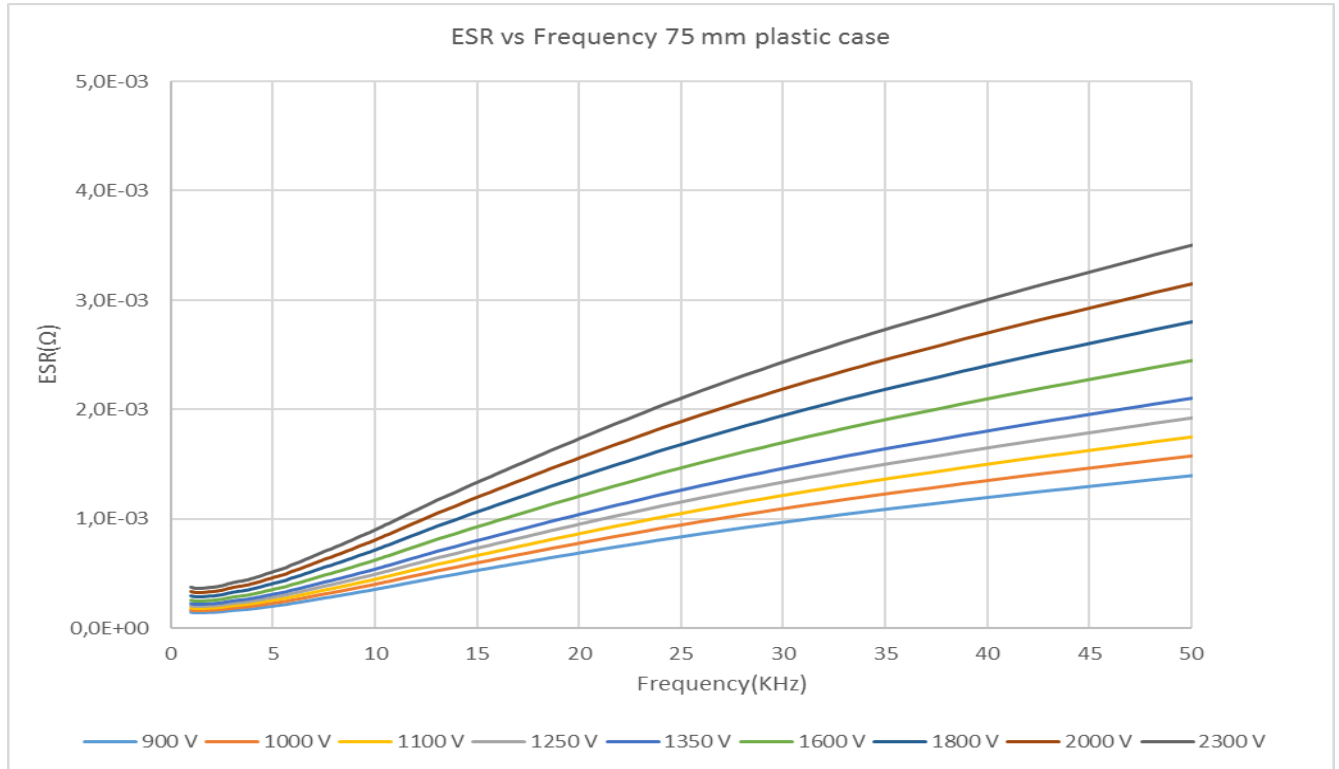
**ESR vs Frequency**

- No internal resonances.

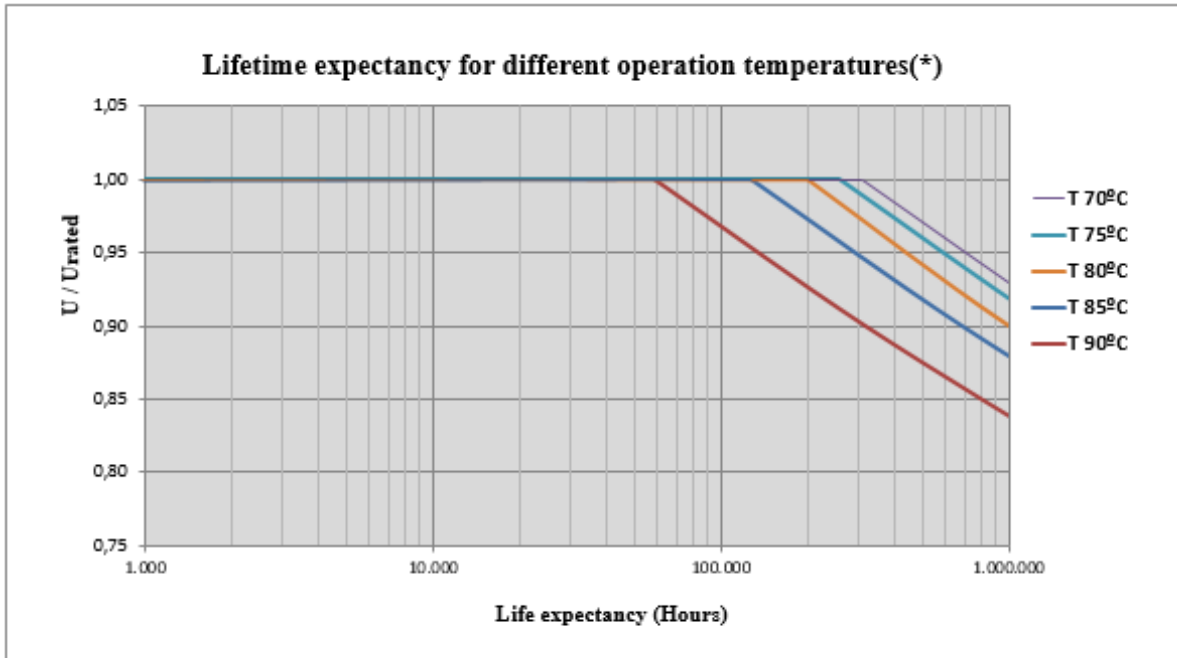
**Lifetime expectancy**

(\*) Homogeneous dielectric temperatures

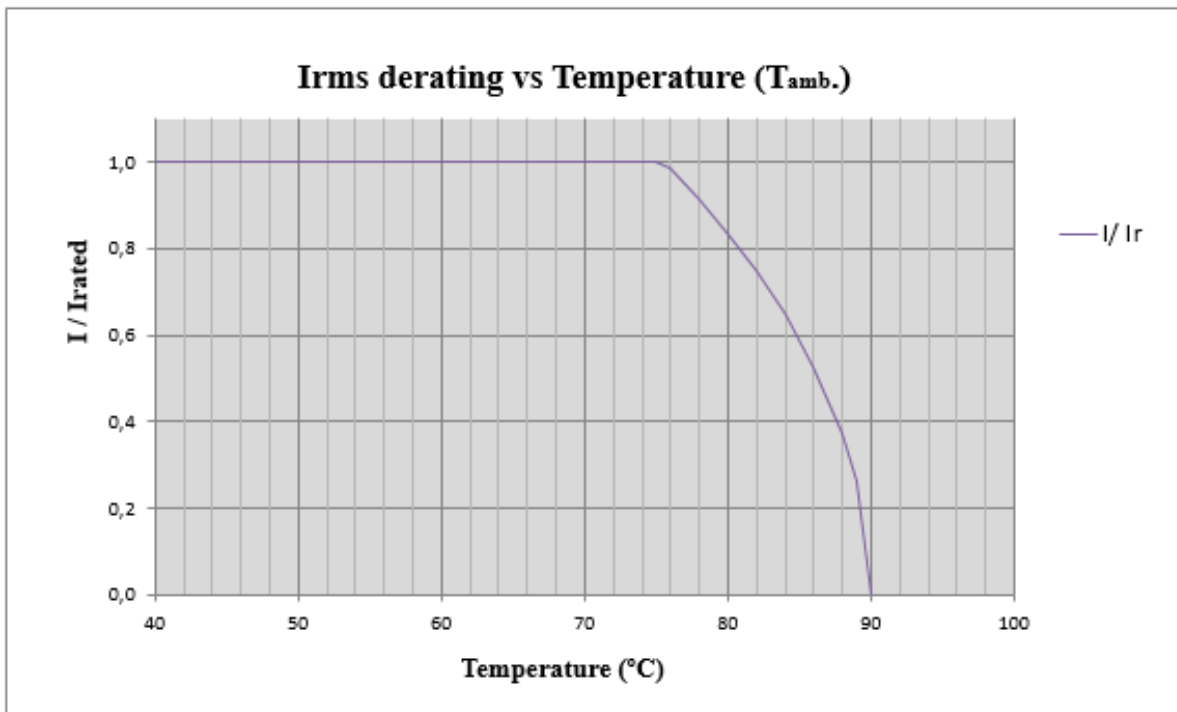

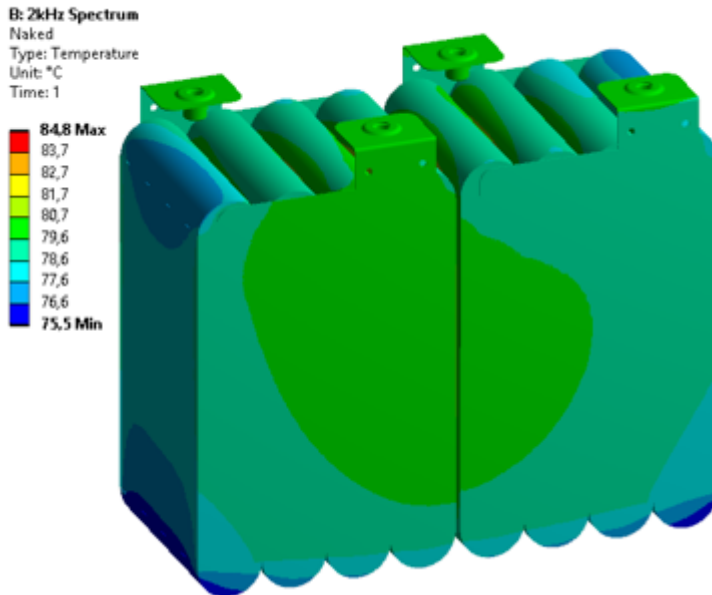
**Thermal stability under specific operation conditions (example)**
*Thermal map, naked capacitor*

**MKK DC-R Modular series:**

- Capacitance: 1 mF
- Current: 155 A
- Power losses: **11 W**
- DeltaT = **15 K**

**Boundary conditions considered:**

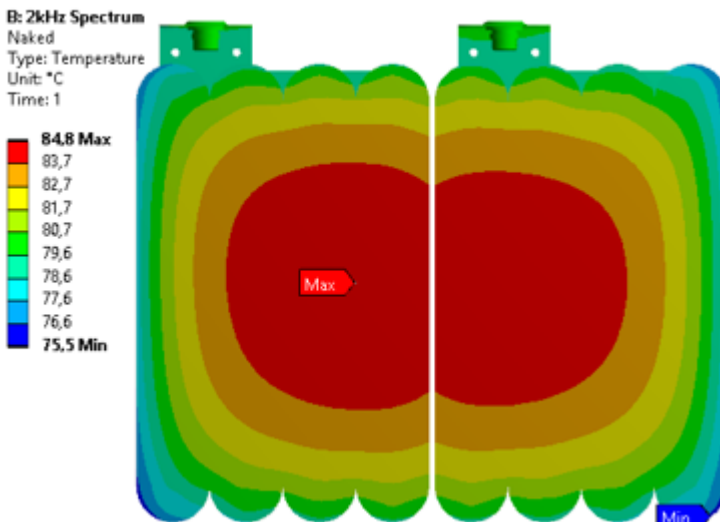
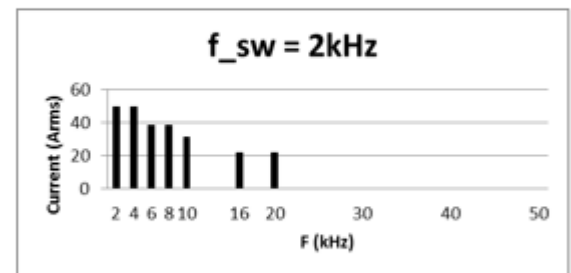
- Ambient temp: 70 °C
- Busbar temp: 80 °C
- Natural convection

*Thermal map, cross section*

*Current spectrum considered*

Standard product – Customized solutions.

- F.E.A. model available for specific simulation according to spectrum and boundary conditions defined by the customer.

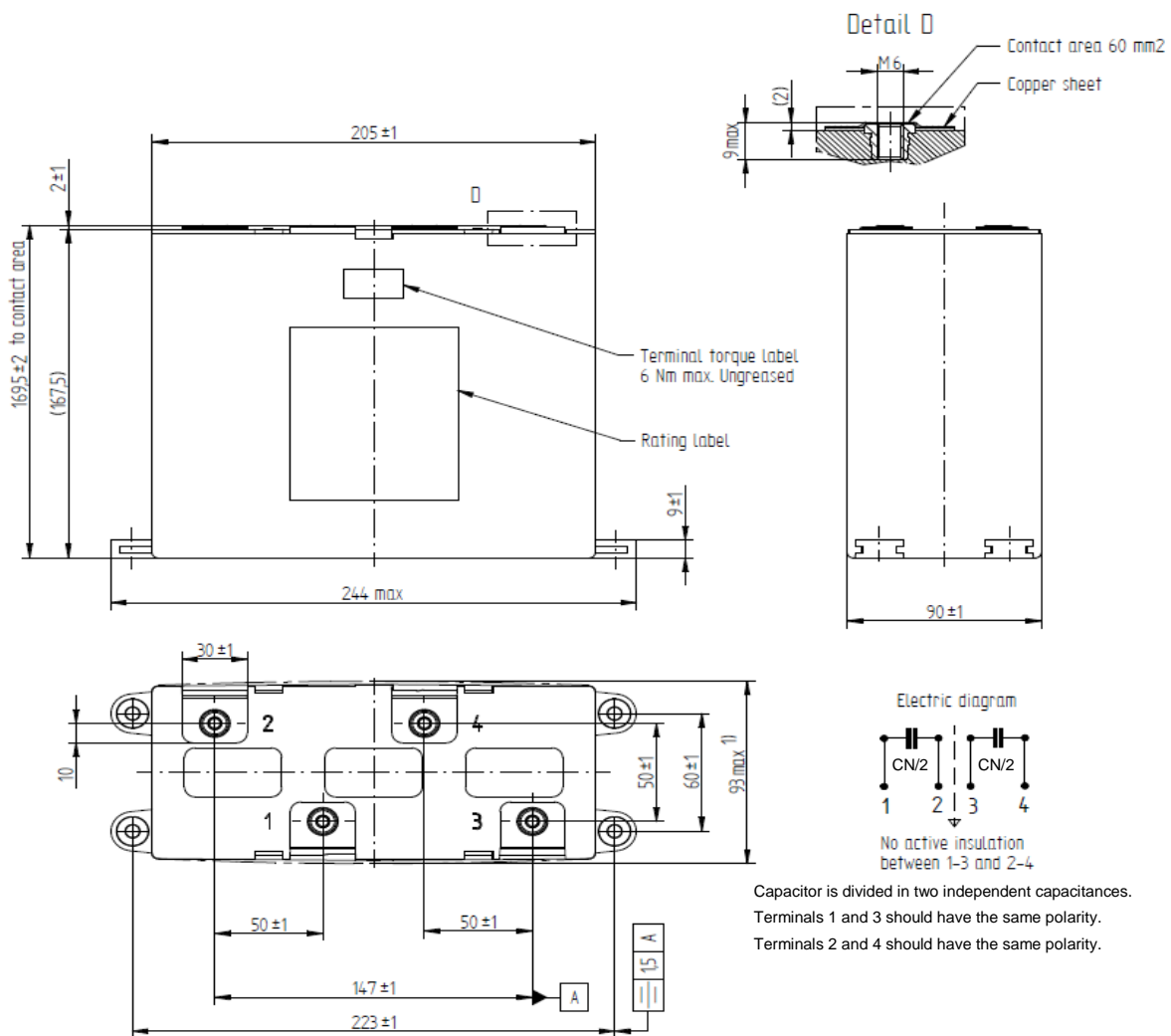
**Dimensional drawing**  
**Construction A:**

**Drawing:**

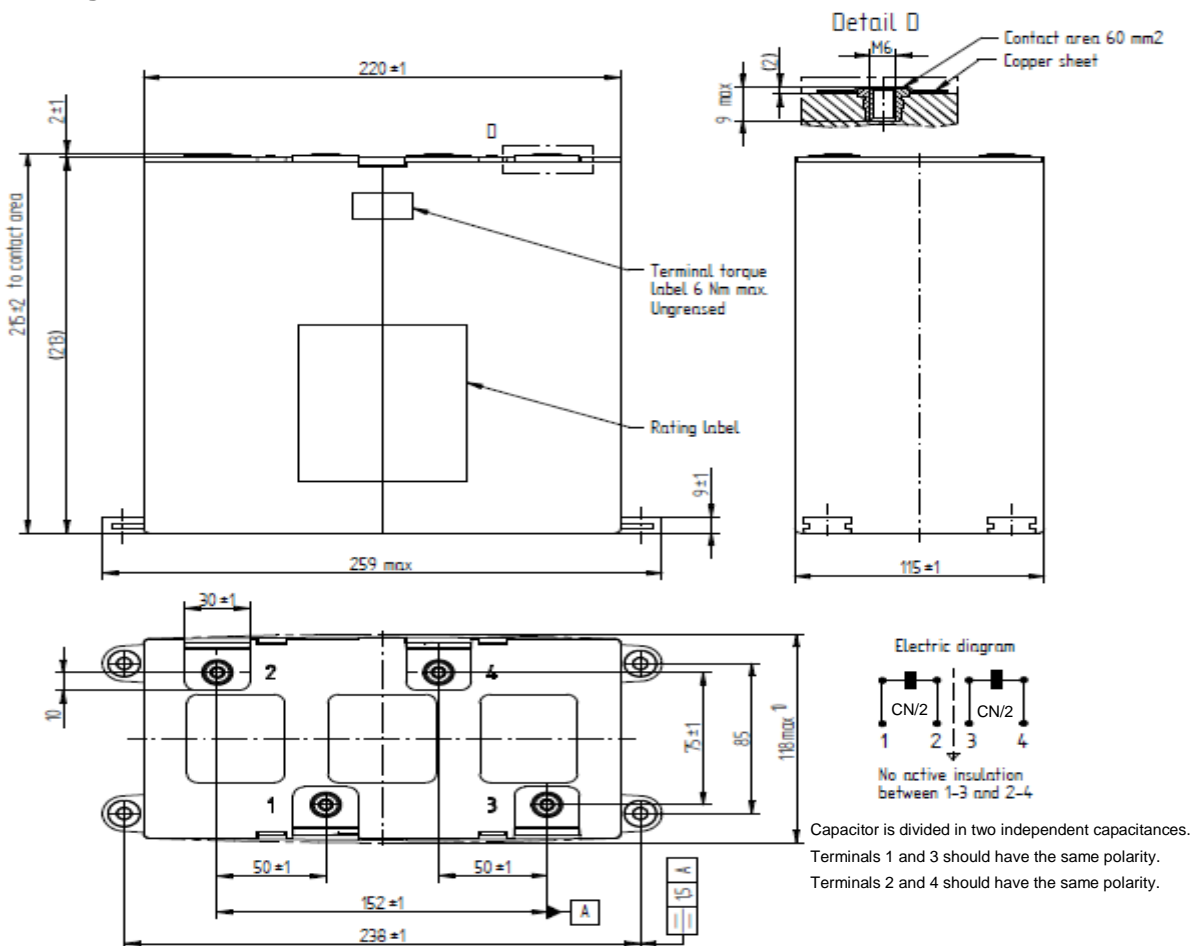

**Construction B**

**Drawing:**

## Important notes

### General safety recommendations

When employed in power electronics applications, the capacitors run with high energy and high currents.

The energy stored in capacitors may be lethal. To prevent any risks of shocks, the capacitor should be discharged with adequate means by qualified people and short-circuited between terminals before handling.

The screws supplied in the terminals of the capacitor are only to ensure the short circuit during transportation and storage, they should not be used for the final connection in the application.

The capacitor can contain dangerous residual charges even after long time without operation. For this reason, the electrical terminals must remain short-circuited until the capacitors are connected in the operating circuit.

TDK Electronics AG cannot predict all possible stresses that a Power Electronic Capacitors can be subjected to. There is a remaining probability of Power Electronic Capacitors showing malfunction due to excess temperature, overvoltage, wrong application, wrong installation, faulty maintenance, mechanical damage, operation at the limits of the specification or other reasons.

### Transportation and handling

- The electrical terminals must not be used for grabbing or suspending the capacitor during transportation and handling.
- Do not handle the capacitor before it is discharged.
- Handle capacitors carefully, because they may still be charged even after disconnection due to faulty discharging devices.
- Protect the capacitor properly against over current and short circuit.
- Failure to follow cautions may result, worst case, in premature failures, bursting and fire.

### Fixing

- The threaded screw 4x Ø6.5 in the bottom of the capacitor has to be used for fixing.

### Storage and operating conditions

Capacitors must never be stored outside the specified temperature and humidity ranges. Capacitors may not be stored in corrosive atmospheres, particularly not when chlorides, sulfides, acids, alkalis, salts, organic solvents or similar substances are present.

|

The following applies to all products named in this publication:

1. Some parts of this publication contain **statements about the suitability of our products areas of application**. These statements are based on our knowledge of typical requirements that are often placed on our products in the areas of application concerned. We nevertheless expressly point out **that such statements cannot be regarded as binding statements about the suitability of our products for a particular customer application**. As a rule, TDK ELECTRONICS A.G. is either unfamiliar with individual customer applications or less familiar with them than the customers themselves are. For these reasons, it is always ultimately incumbent on the customer to check and decide whether a TDK ELECTRONICS A.G. product with the properties described in the product specification is suitable for use in a particular customer application.
2. We also point out that **in individual cases, a malfunction of electronic components or failure before the end of their usual service life cannot be completely ruled out in the current state of the art, even if they are operated as specified**. In customer applications requiring a very high level of operational safety and especially in customer applications in which the malfunction or failure of an electronic component could endanger human life or health (e.g. in accident prevention or life-saving systems), it must therefore be ensured by means of suitable design of the customer application or other action taken by the customer (e.g. installation of protective circuitry or redundancy) that no injury or damage is sustained by third parties in the event of malfunction or failure of an electronic component.
3. **The warnings, cautions and product-specific notes must be observed.**
4. In order to satisfy certain technical requirements, **some of the products described in this publication may contain substances subject to restrictions in certain jurisdictions (e.g. because they are classed as hazardous)**. Useful information on this will be found in our Material Data Sheets on the Internet (<https://www.tdkelectronics.tdk.com/en/176050/company/environmental-protection/material-data-sheets>). Should you have any more detailed questions, please contact our sales offices.
5. We constantly strive to improve our products. Consequently, **the products described in this publication may change from time to time**. The same is true of the corresponding product specifications. Please check therefore to what extent product descriptions and specifications contained in this publication are still applicable before or when you place an order. We also **reserve the right to discontinue production and delivery of products**. Consequently, we cannot guarantee that all products named in this publication will always be available. The aforementioned does not apply in the case of individual agreements deviating from the foregoing for customer specific products.
6. Unless otherwise agreed in individual contracts, **all orders are subject to the current version of the “General Terms of Delivery for Products and Services in the Electrical Industry” published by the German Electrical and Electronics Industry Association (ZVEI)**.
7. **Our manufacturing sites serving the automotive business apply the IATF 16949 standard**. The IATF certifications confirm our compliance with requirements regarding the quality management system in the automotive industry. Referring to customer requirements and customer specific requirements (“CSR”) TDK ELECTRONICS A.G. always has and will continue to have the policy of respecting individual agreements. Even if IATF 16949 may appear to support the acceptance of unilateral requirements, we hereby like to emphasize that **only requirements mutually agreed upon can and will be implemented in our Quality Management System**. For clarification purposes we like to point out that obligations from IATF 16949 shall only become legally binding if individually agreed upon.

8. The trade names TDK , CeraCharge, CeraDiode, CeraLink, CeraPad, CeraPlas, CSMP, CTVS, DeltaCap, DigiSiMic, ExoCore, FilterCap, FormFit, LeaXield, MiniBlue, MiniCell, MKD, MKK, MotorCap, PCC, PhaseCap, PhaseCube, PhaseMod, PhiCap, PowerHap, PQSine, PQvar, SIFERRIT, SIFI, SIKOREL, SilverCap, SIMDAD, SiMic, SIMID, SineFormer, SIOV, ThermoFuse, WindCap are **trademarks registered or pending** in Europe and in other countries. Further information will be found on the Internet at

<https://www.tdkelectronics.tdk.com/en/513784/channel/trademarks/508492>.

#### **Risk Minimization with Protective Devices for Power Electronic Capacitors**

The German Electrical and Electronic Manufacturers' Association - ZVEI - is advising the implementation of Protective Devices when using Power Electronic Capacitors as a suitable measure to eliminate danger to humans and property to the largest extent.

The utilization of Protection Devices will significantly reduce the risk of active capacitor failures which could occur due to the high amount of energy stored and the possibility of creating flammable gases [Ref 3].

TDK ELECTRONICS A.G. cannot predict all possible stresses, which a Power Electronic Capacitor can be subjected to. There is a remaining probability of Power Electronic Capacitors showing malfunction due to excess temperature, overvoltage, wrong application, wrong installation, faulty maintenance, mechanical damage, operation at the technical limits of the specification or other reasons. As a member of ZVEI, TDK ELECTRONICS A.G. is recommending the use of power electronic capacitors equipped with appropriate protective devices, such as over-pressure switches and will be glad to provide concrete technical recommendations regarding Protective Devices during the creation of a Power Electronic Capacitor specification.

TDK ELECTRONICS A.G. has collected profound experience in designing Power Electronic Capacitors compliant with the international standards (see Ref.1 & 2.).

[Ref.1] IEC 61071: Capacitors for power electronics

[Ref.2] IEC 61881-1: Railway applications – Rolling stock equipment – Capacitors for power electronics –

[Ref.3] ZVEI Power Capacitors Division - General Safety Data Sheet for Power Capacitors

(<https://www.zvei.org/en/association/divisions/power-capacitors-division/general-safety-recommendations-forpower-capacitors/>)