

# MC 1,5/ 3-STF-3,5 - PCB connector



1847068

<https://www.phoenixcontact.com/us/products/1847068>

Please be informed that the data shown in this PDF document is generated from our online catalog. Please find the complete data in the user documentation. Our general terms of use for downloads are valid.

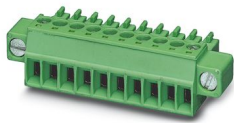

PCB connector, nominal cross section: 1.5 mm<sup>2</sup>, color: green, nominal current: 8 A, rated voltage (III/2): 160 V, contact surface: Tin, contact connection type: Socket, number of potentials: 3, number of rows: 1, number of positions: 3, number of connections: 3, product range: MC 1,5/..-STF, pitch: 3.5 mm, connection method: Screw connection with tension sleeve, screw head form: L Slotted, conductor/PCB connection direction: 0 °, plug-in system: COMBICON MC 1,5, locking: Screw locking mechanism, mounting: Screw flange, type of packaging: packed in cardboard

## Your advantages

- Well-known connection principle allows worldwide use
- Low temperature rise, thanks to maximum contact force
- Allows connection of two conductors
- Screwable flange for superior mechanical stability

## Commercial data

Item number	1847068
Packing unit	250 pc
Minimum order quantity	250 pc
Sales key	AA02
Product key	AABAAB
Catalog page	Page 191 (C-1-2013)
GTIN	4017918113452
Weight per piece (including packing)	2.96 g
Weight per piece (excluding packing)	2.823 g
Customs tariff number	85366990
Country of origin	DE

# MC 1,5/ 3-STF-3,5 - PCB connector



1847068

<https://www.phoenixcontact.com/us/products/1847068>

## Technical data

### Product properties

Product type	PCB connector
Product family	MC 1,5/...-STF
Product line	COMBICON Connectors S
Type	Standard
Number of positions	3
Pitch	3.5 mm
Number of connections	3
Number of rows	1
Number of potentials	3
Mounting flange	Screw flange

### Electrical properties

Nominal current $I_N$	8 A
Nominal voltage $U_N$	160 V
Degree of pollution	3
Contact resistance	1.3 m $\Omega$
Rated voltage (III/3)	160 V
Rated surge voltage (III/3)	2.5 kV
Rated voltage (III/2)	160 V
Rated surge voltage (III/2)	2.5 kV
Rated voltage (II/2)	320 V
Rated surge voltage (II/2)	2.5 kV

### Connection data

#### Connection technology

Type	Standard
Connector system	COMBICON MC 1,5
Nominal cross section	1.5 mm <sup>2</sup>
Contact connection type	Socket

#### Interlock

Locking type	Screw locking mechanism
Mounting flange	Screw flange
Tightening torque	0.3 Nm

#### Conductor connection

Connection method	Screw connection with tension sleeve
Conductor/PCB connection direction	0 °
Conductor cross section rigid	0.14 mm <sup>2</sup> ... 1.5 mm <sup>2</sup>
Conductor cross section flexible	0.14 mm <sup>2</sup> ... 1.5 mm <sup>2</sup>
Conductor cross section AWG	28 ... 16

# MC 1,5/ 3-STF-3,5 - PCB connector

1847068

<https://www.phoenixcontact.com/us/products/1847068>

Conductor cross section flexible, with ferrule without plastic sleeve	0.25 mm <sup>2</sup> ... 1.5 mm <sup>2</sup>
Conductor cross section, flexible, with ferrule, with plastic sleeve	0.25 mm <sup>2</sup> ... 0.5 mm <sup>2</sup>
2 conductors with same cross section, solid	0.08 mm <sup>2</sup> ... 0.5 mm <sup>2</sup>
2 conductors with same cross section, flexible	0.08 mm <sup>2</sup> ... 0.75 mm <sup>2</sup>
2 conductors with same cross section, flexible, with ferrule without plastic sleeve	0.25 mm <sup>2</sup> ... 0.34 mm <sup>2</sup>
2 conductors with the same cross section, flexible, with TWIN ferrule with plastic sleeve	0.5 mm <sup>2</sup> ... 0.5 mm <sup>2</sup>
Cylindrical gauge a x b / diameter	2.4 mm x 1.5 mm / 1.6 mm
Stripping length	7 mm
Tightening torque	0.22 Nm ... 0.25 Nm

## Specifications for ferrules without insulating collar

recommended crimping tool	1212034 CRIMPFOX 6
---------------------------	--------------------

## Specifications for ferrules with insulating collar

recommended crimping tool	1212034 CRIMPFOX 6
---------------------------	--------------------

## Material specifications

### Material data - contact

Note	WEEE/RoHS-compliant, free of whiskers according to IEC 60068-2-82/JEDEC JESD 201
Contact material	Cu alloy
Surface characteristics	hot-dip tin-plated
Metal surface terminal point (top layer)	Tin (4 - 8 µm Sn)
Metal surface contact area (top layer)	Tin (4 - 8 µm Sn)

### Material data - housing

Color (Housing)	green (6021)
Insulating material	PA
Insulating material group	I
CTI according to IEC 60112	600
Flammability rating according to UL 94	V0
Glow wire flammability index GWFI according to EN 60695-2-12	850
Glow wire ignition temperature GWIT according to EN 60695-2-13	775
Temperature for the ball pressure test according to EN 60695-10-2	125 °C

## Dimensions

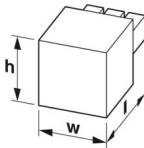
Dimensional drawing	
---------------------	--

# MC 1,5/ 3-STF-3,5 - PCB connector



1847068

<https://www.phoenixcontact.com/us/products/1847068>

Pitch	3.5 mm
Width [w]	20.8 mm
Height [h]	11.1 mm
Length [l]	16.1 mm

## Mounting

Drive form screw head	Slotted (L)
-----------------------	-------------

## Flange

Tightening torque	0.3 Nm
-------------------	--------

## Mechanical tests

### Test for conductor damage and slackening

Specification	IEC 60999-1:1999-11
Result	Test passed

### Pull-out test

Specification	IEC 60999-1:1999-11
Conductor cross section/conductor type/tractive force setpoint/actual value	0.14 mm <sup>2</sup> / solid / > 10 N
	0.14 mm <sup>2</sup> / flexible / > 10 N
	1.5 mm <sup>2</sup> / solid / > 40 N
	1.5 mm <sup>2</sup> / flexible / > 40 N

### Insertion and withdrawal forces

Result	Test passed
No. of cycles	25
Insertion strength per pos. approx.	6 N
Withdraw strength per pos. approx.	4 N

### Torque test

Specification	IEC 60999-1:1999-11
---------------	---------------------

### Resistance of inscriptions

Specification	IEC 60068-2-70:1995-12
Result	Test passed

### Polarization and coding

Specification	IEC 60512-13-5:2006-02
Result	Test passed

### Visual inspection

Specification	IEC 60512-1-1:2002-02
Result	Test passed

### Dimension check

Specification	IEC 60512-1-2:2002-02
Result	Test passed

# MC 1,5/ 3-STF-3,5 - PCB connector



1847068

<https://www.phoenixcontact.com/us/products/1847068>

## Environmental and real-life conditions

### Vibration test

Specification	IEC 60068-2-6:2007-12
Frequency	10 - 150 - 10 Hz
Sweep speed	1 octave/min
Amplitude	0.35 mm (10 Hz ... 60.1 Hz)
Acceleration	5g (60.1 Hz ... 150 Hz)
Test duration per axis	2.5 h

### Durability test

Specification	IEC 60512-9-1:2010-03
Impulse withstand voltage at sea level	2.95 kV
Contact resistance $R_1$	1.3 m $\Omega$
Contact resistance $R_2$	1.4 m $\Omega$
Insertion/withdrawal cycles	25
Insulation resistance, neighboring positions	> 5 M $\Omega$

### Climatic test

Specification	ISO 6988:1985-02
Corrosive stress	0.2 dm <sup>3</sup> SO <sub>2</sub> on 300 dm <sup>3</sup> /40 °C/1 cycle
Thermal stress	100 °C/168 h
Power-frequency withstand voltage	1.39 kV

### Shocks

Specification	IEC 60068-2-27:2008-02
Pulse shape	Semi-sinusoidal
Acceleration	30g
Shock duration	18 ms
Test directions	X-, Y- and Z-axis (pos. and neg.)

### Ambient conditions

Ambient temperature (operation)	-40 °C ... 100 °C (dependent on the derating curve)
Ambient temperature (storage/transport)	-40 °C ... 70 °C
Relative humidity (storage/transport)	30 % ... 70 %
Ambient temperature (assembly)	-5 °C ... 100 °C

## Electrical tests

### Thermal test | Test group C

Specification	IEC 60512-5-1:2002-02
Tested number of positions	20

### Insulation resistance

Specification	IEC 60512-3-1:2002-02
Insulation resistance, neighboring positions	> 5 M $\Omega$

# MC 1,5/ 3-STF-3,5 - PCB connector



1847068

<https://www.phoenixcontact.com/us/products/1847068>

## Air clearances and creepage distances |

Specification	IEC 60664-1:2007-04
Insulating material group	I
Comparative tracking index (IEC 60112)	CTI 600
Rated insulation voltage (III/3)	160 V
Rated surge voltage (III/3)	2.5 kV
minimum clearance value - non-homogenous field (III/3)	1.5 mm
minimum creepage distance (III/3)	2 mm
Rated insulation voltage (III/2)	160 V
Rated surge voltage (III/2)	2.5 kV
minimum clearance value - non-homogenous field (III/2)	1.5 mm
minimum creepage distance (III/2)	1.5 mm
Rated insulation voltage (II/2)	320 V
Rated surge voltage (II/2)	2.5 kV
minimum clearance value - non-homogenous field (II/2)	1.5 mm
minimum creepage distance (II/2)	1.6 mm

## Packaging specifications

Type of packaging	packed in cardboard
-------------------	---------------------

# MC 1,5/ 3-STF-3,5 - PCB connector



1847068

<https://www.phoenixcontact.com/us/products/1847068>

## Drawings

Diagram

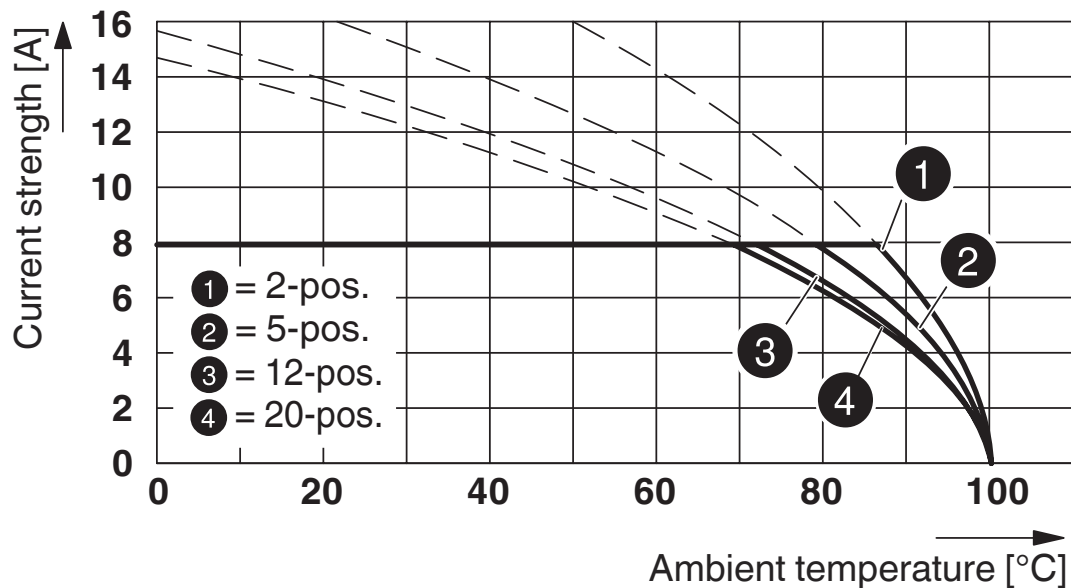

Type: MC 1,5/...-STF-3,5 with MC 1,5/...-GF-3,5

Diagram

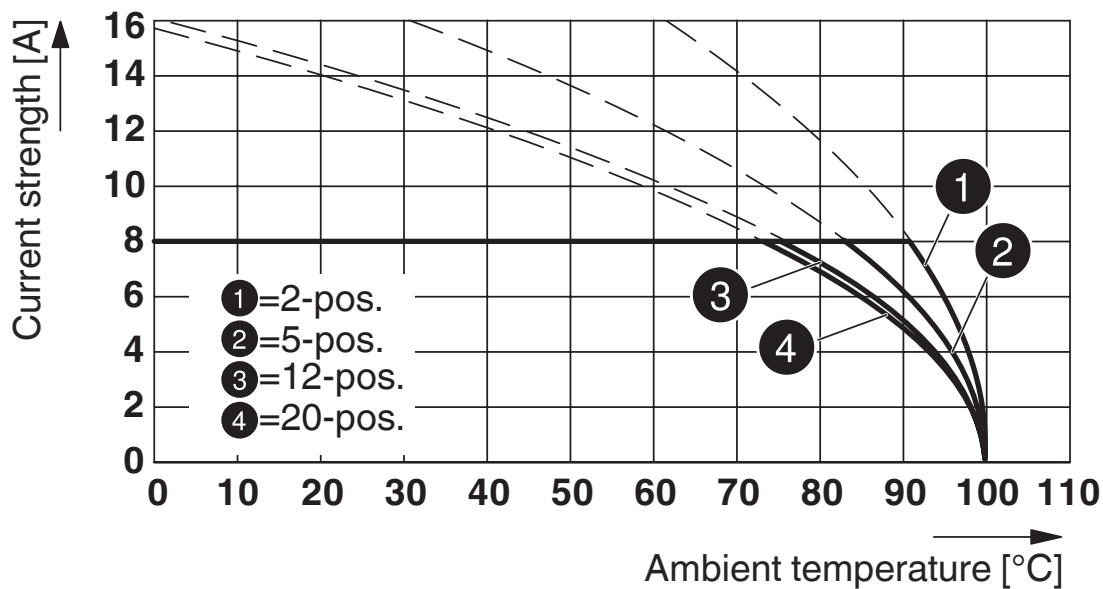

Type: MC 1,5/...-STF-3,5 with MCV 1,5/...-GF-3,5

# MC 1,5/ 3-STF-3,5 - PCB connector



1847068

<https://www.phoenixcontact.com/us/products/1847068>

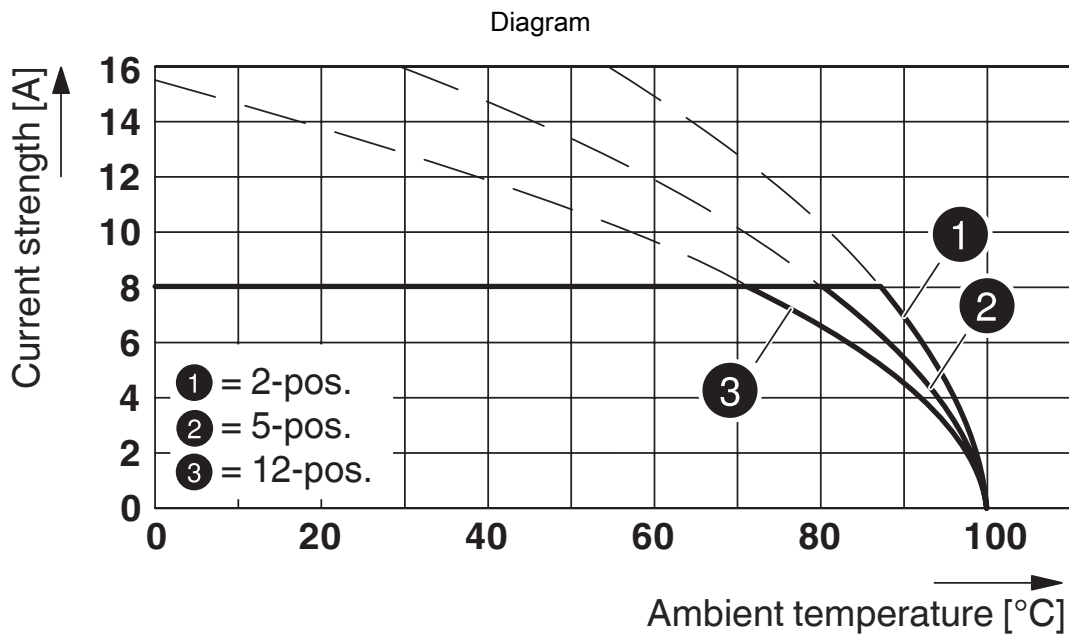

Type: MC 1,5/...-ST(F)-3,5 with MCV 1,5/...-G(F)-3,5 P... THR

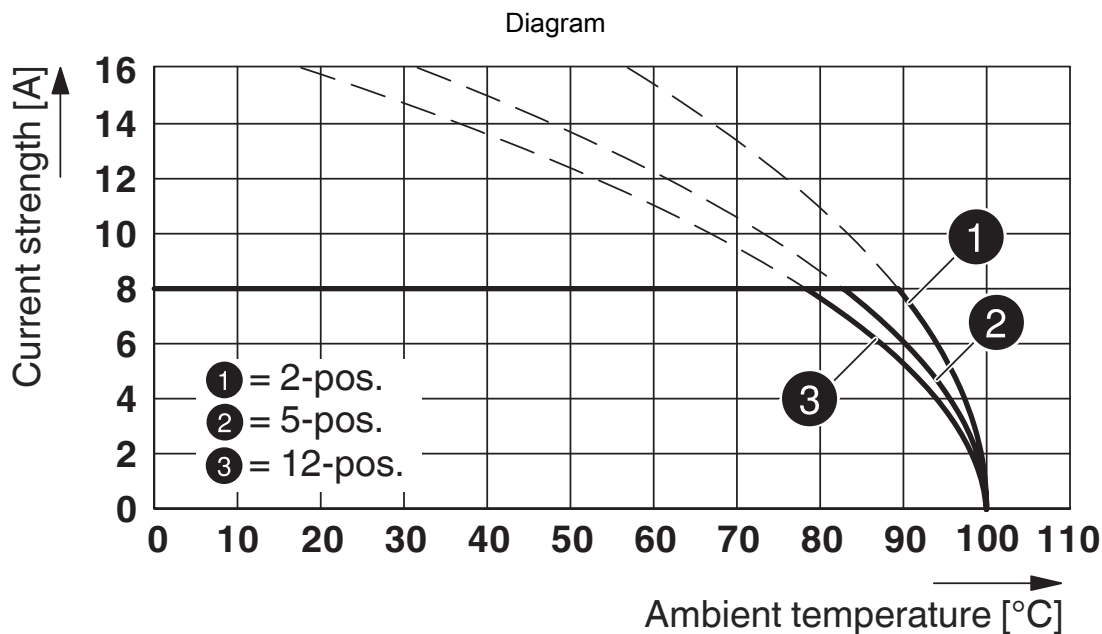

Type: MC 1,5/...-STF-3,5 with MCV 1,5/...-GSF-3,5 P26 THT



# MC 1,5/ 3-STF-3,5 - PCB connector

1847068

<https://www.phoenixcontact.com/us/products/1847068>

Dimensional drawing

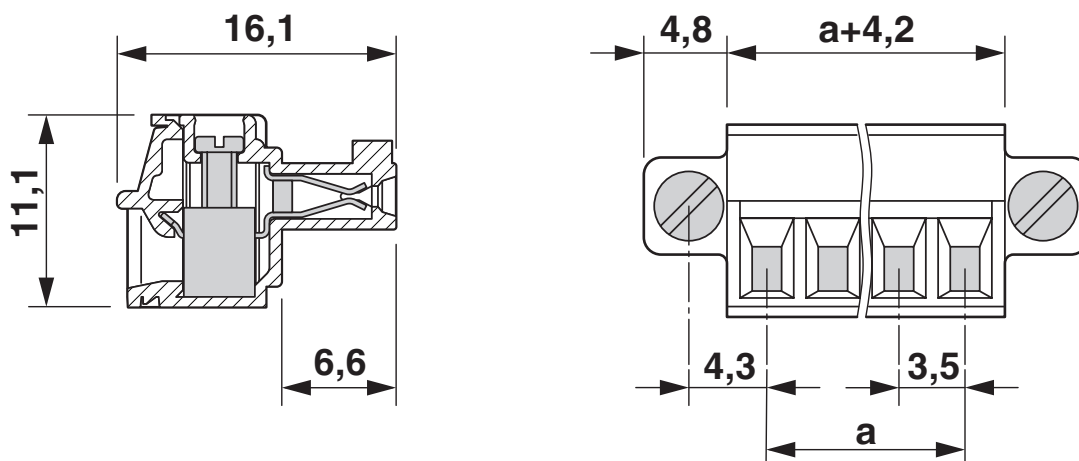

Diagram

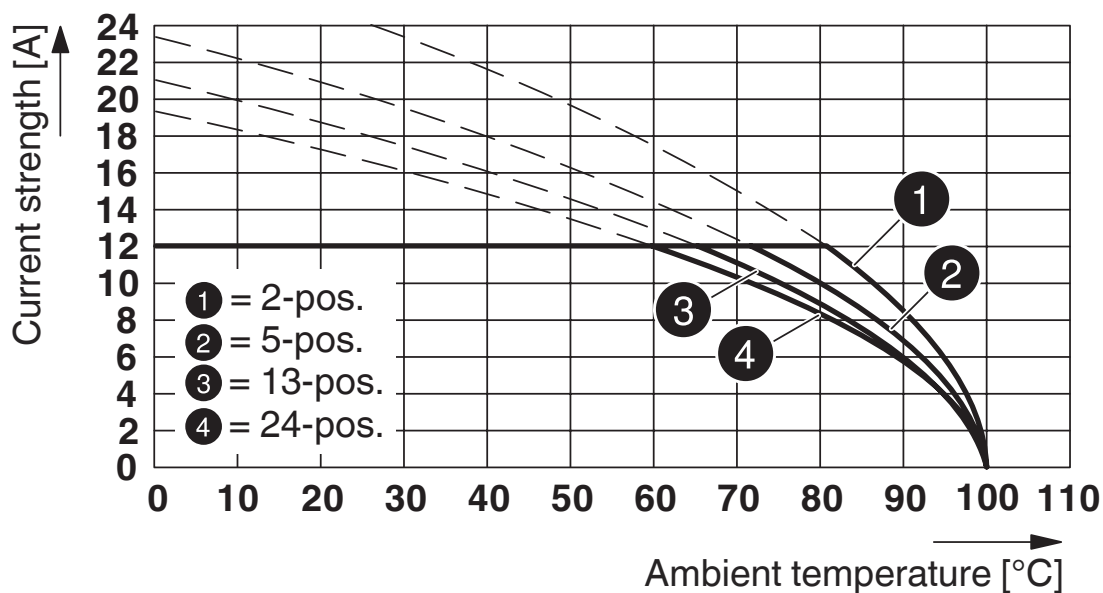

Type: MC 1,5/...-ST(F)-3,5 with MC 1,5/...-G(F)-3,5 P... THR

# MC 1,5/ 3-STF-3,5 - PCB connector





1847068

<https://www.phoenixcontact.com/us/products/1847068>

## Approvals

To download certificates, visit the product detail page: <https://www.phoenixcontact.com/us/products/1847068>

 <b>CSA</b> Approval ID: 13631				
	Nominal voltage $U_N$	Nominal current $I_N$	Cross section AWG	Cross section $\text{mm}^2$
Use group B	300 V	8 A	28 - 16	-
Use group D	300 V	8 A	28 - 16	-

 <b>cULus Recognized</b> Approval ID: E60425-20110128				
	Nominal voltage $U_N$	Nominal current $I_N$	Cross section AWG	Cross section $\text{mm}^2$
Use group B	300 V	8 A	30 - 14	-
Use group D	300 V	8 A	30 - 14	-

 <b>VDE Zeichengenehmigung</b> Approval ID: 40011723				
	Nominal voltage $U_N$	Nominal current $I_N$	Cross section AWG	Cross section $\text{mm}^2$
	160 V	8 A	-	0.2 - 1.5

# MC 1,5/ 3-STF-3,5 - PCB connector



1847068

<https://www.phoenixcontact.com/us/products/1847068>

## Classifications

### ECLASS

ECLASS-11.0	27460202
ECLASS-12.0	27460202
ECLASS-13.0	27460202

### ETIM

ETIM 9.0	EC002638
----------	----------

### UNSPSC

UNSPSC 21.0	39121400
-------------	----------

# MC 1,5/ 3-STF-3,5 - PCB connector



1847068

<https://www.phoenixcontact.com/us/products/1847068>

## Environmental product compliance

### EU RoHS

Fulfills EU RoHS substance requirements	Yes, No exemptions
---	--------------------

### China RoHS

Environment friendly use period (EFUP)	EFUP-E
	No hazardous substances above the limits

### EU REACH SVHC

REACH candidate substance (CAS No.)	No substance above 0.1 wt%
-------------------------------------	----------------------------

# MC 1,5/ 3-STF-3,5 - PCB connector

1847068

<https://www.phoenixcontact.com/us/products/1847068>



## Accessories

### SK 3,5/2,8:FORTL.ZAHLEN - Marker card

0804073

<https://www.phoenixcontact.com/us/products/0804073>



Marker card, Sheet, white, labeled, horizontal: consecutive numbers 1 ... 10, 11 .. 20, etc. up to 91 ... 99, mounting type: adhesive, for terminal block width: 3.5 mm, lettering field size: 3.5 x 2.8 mm, Number of individual labels: 14

---

### SZS 0,4X2,5 VDE - Screwdriver

1205037

<https://www.phoenixcontact.com/us/products/1205037>



Screwdriver, slot-headed, VDE insulated, size: 0.4 x 2.5 x 80 mm, 2-component grip, with non-slip grip

# MC 1,5/ 3-STF-3,5 - PCB connector

1847068

<https://www.phoenixcontact.com/us/products/1847068>



## MCV 1,5/ 3-GF-3,5 P20 THRR56 - PCB header

1780684

<https://www.phoenixcontact.com/us/products/1780684>

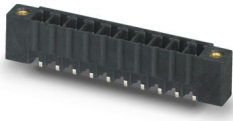

PCB headers, nominal cross section: 1.5 mm<sup>2</sup>, color: black, nominal current: 8 A, rated voltage (III/2): 160 V, contact surface: Tin, contact connection type: Pin, number of potentials: 3, number of rows: 1, number of positions: 3, number of connections: 3, product range: MCV 1,5/..-GF-THR, pitch: 3.5 mm, mounting: THR soldering, pin layout: Linear pinning, solder pin [P]: 2 mm, number of solder pins per potential: 1, plug-in system: COMBICON MC 1,5, Pin connector pattern alignment: Standard, locking: Screw locking mechanism, mounting: Threaded flange, type of packaging: 56 mm wide tape, For user information and design recommendations for through-hole reflow technology, go to: Downloads

## MC 1,5/ 3-GF-3,5 P26 THR - PCB header

1789180

<https://www.phoenixcontact.com/us/products/1789180>



PCB headers, nominal cross section: 1.5 mm<sup>2</sup>, color: black, nominal current: 8 A, rated voltage (III/2): 160 V, contact surface: Tin, contact connection type: Pin, number of potentials: 3, number of rows: 1, number of positions: 3, number of connections: 3, product range: MC 1,5/..-GF-THR, pitch: 3.5 mm, mounting: THR soldering, pin layout: Linear pinning, solder pin [P]: 2.6 mm, number of solder pins per potential: 1, plug-in system: COMBICON MC 1,5, Pin connector pattern alignment: Standard, locking: Screw locking mechanism, mounting: Threaded flange, type of packaging: packed in cardboard

Phoenix Contact 2024 © - all rights reserved  
<https://www.phoenixcontact.com>

Phoenix Contact USA  
586 Fulling Mill Road  
Middletown, PA 17057, United States  
(+717) 944-1300  
[info@phoenixcon.com](mailto:info@phoenixcon.com)