

## PRG Series



## PTC Thermistor (Resettable Fuse)

### PRG Series

#### Features

- Compact Design to save Board space
- Low profile
- High Reliability
- Less Characteristics change after mounting and energization
- RoHS Compliant and Halogen Free
- Safety Standard  
(UL : E137188 VDE, TUV etc.)
- Wide range of Operating Temperature  
(-20 to 85 degree)
- Fastest time to trip
- Current 10 to 75mA
- Voltage up to 32V

#### Applications

- Automotive
- (LED Lamp/Navigation/Motor/Electrical Component)
- Factory Automation Equipment
- (Motor Drive, Sensor controller)
- Charger
- USB port protection
- Mobile phone of Battery and Port protection
- Note PC, Tablet PC

#### Overview

The PRG series (Resettable fuse) of PTC thermistors for short protection device features rapid operation to protect the circuit as an abnormal current is generated, for example due to a short circuit.

These products automatically return to their initial state when the overcurrent is eliminated and can be used repeatedly.

Use of ceramics material means high reliability and quick protection after short circuits, allowing the customer to make equipment safer and maintenance-free.

Compared with organic PTC elements and chip resistors having the same characteristics, the PRG series features high reliability for less characteristics change after mounting and get long life cycle.

This helps the customer downsize equipment and high performance.

---

#### Attention:

This datasheet is downloaded from the website of Murata Manufacturing Co., Ltd.  
Therefore, it's specifications are subject to change or our products in it may be discontinued without advance notice.  
Please check with our sales representatives or product engineers before ordering.

## TABLE OF CONTENT

<b>1. Introduction</b> .....	<b>1</b>
<b>2. Selection Guide</b> .....	<b>3</b>
2.1 Model Numbering System	
<b>3. Specifications</b> .....	<b>4</b>
3.1 Line up	
3.2 Time to trip	
3.3 Operating Time	
3.4 Electrical characteristics	
3.5 Mechanical characteristics	
3.6 Environmental characteristics	
<b>4. Measurement direction</b>	
4.1 Technical performance Characteristic .....	<b>9</b>
<b>5. Dimension, Land Pattern</b> .....	<b>10</b>
<b>6. Packing</b> .....	<b>11</b>
6.1 Taping Specification	
<b>7. ⚠CAUTION</b> .....	<b>14</b>
7.1 Caution	
7.2 Notice	
7.3 Note	

---

### Attention:

This datasheet is downloaded from the website of Murata Manufacturing Co., Ltd.  
Therefore, it's specifications are subject to change or our products in it may be discontinued without advance notice.  
Please check with our sales representatives or product engineers before ordering.

## 2. Selection Guide

### 2.1 Model Numbering System

PTC Thermistors (POSISTOR®) for Circuit Protection

(Part Number)

PR	G	18	BB	470	M	B1	RB
①	②	③	④	⑤	⑥	⑦	⑧

#### 1. Product ID

Product ID	
PR	PTC Thermistors Chip Type

#### 2. Series

Code	Series
G	for Overcurrent Protection

#### 3. Dimensions

Code	Dimensions
15	1.00 × 0.50mm
18	1.60 × 0.80mm
21	2.00 × 1.25mm

#### 4. Temperature Characteristics

Code	Temperature Characteristics
BB	Curie Point 100°C
BC	Curie Point 90°C

#### 5. Resistance

Expressed by three figures. The unit is ( $\Omega$ ).

The first and second figures are significant digits, and the third figure expresses the number of zeros which follow the two figures.

If there is a decimal point, it is expressed by the capital letter "R".

In this case, all figures are significant digits.

Ex.)

Code	Resistance
4R7	4.7 $\Omega$
470	47 $\Omega$
471	470 $\Omega$

#### 6. Resistance Tolerance

Code	Resistance Tolerance
M	+/-20

#### 7. Individual Specifications

Ex.)

Code	Individual Specifications
B1,M1	Structure, others

#### 8. Packaging

Code	Packaging
RA	Plastic Taping 4mm Pitch (4000pcs.)
RB	Paper Taping 4mm Pitch (4000pcs.)
RC	Paper Taping 2mm Pitch (10000pcs.)
RK	Plastic Taping 4mm Pitch (3000pcs.)

#### Attention:

This datasheet is downloaded from the website of Murata Manufacturing Co., Ltd. Therefore, its specifications are subject to change or our products in it may be discontinued without advance notice. Please check with our sales representatives or product engineers before ordering.

### 3. Specifications

#### 3.1 Line up

Size [mm/in.]	Part Number	Resistance at 25°C [ohm]	Max. Voltage [VDC]	Max. Current [A]	Hold Current [mA]					Trip Current [mA]		Operation Temp. [°C]
					at 25°C	at 60°C	at 70°C	at 75°C	at 85°C	at -20°C	at 25°C	
1005/0402	PRG15BC2R2MM1RC	2.2±20%	6	3.41	134	88	76	-	56	335	252	-20°C~+85°C
	PRG15BC3R3MM1RC	3.3±20%	9	3.41	110	71	60	-	45	273	205	
	PRG15BC4R7MM1RC	4.7±20%	9	2.40	91	60	50	-	38	229	172	
	PRG15BC180MM1RC	18±20%	16	1.12	47	31	26	-	19	132	98	
	PRG15BC220MM1RC	22±20%	16	0.91	43	28	23	-	17	119	90	
	PRG15BC330MM1RC	33±20%	30	1.14	38	25	21	-	15	97	73	
	PRG15BC470MM1RC	47±20%	30	0.80	32	20	17	-	12	82	62	
	PRG15BC680MM1RC	68±20%	30	0.56	26	17	14	-	10	69	52	
1608/0603	PRG18BC1R0MM1RB	1.0±20%	6	7.50	330	220	180	-	120	880	740	-20°C~+85°C
	PRG18BC2R2MM1RB	2.2±20%	12	6.81	220	150	120	-	80	625	500	
	PRG18BC3R3MM1RB	3.3±20%	16	6.07	180	120	98	-	65	500	400	
	PRG18BC4R7MM1RB	4.7±20%	20	5.32	155	100	80	-	52	420	330	
	PRG18BC6R8MM1RB	6.8±20%	20	3.68	120	80	65	-	45	335	260	
	PRG18BC100MM1RB	10±20%	30	3.75	80	55	47	-	33	235	165	
	PRG18BC150MM1RB	15±20%	30	2.50	64	45	39	-	27	190	135	-20°C~+75°C
	PRG18BC220MM1RB	22±20%	30	1.71	54	37	31	-	22	155	113	
	PRG18BB330MB1RB	33±20%	24	0.91	36	25	-	18	-	90	71	
	PRG18BB470MB1RB	47±20%	24	0.64	29	20	-	14	-	78	61	
2012/0805	PRG18BB101MB1RB	100±20%	24	0.30	21	15	-	11	-	57	45	-20°C~+60°C
	PRG18BB221MB1RB	220±20%	24	0.14	14	10	-	8	-	37	29	
	PRG18BB471MB1RB	470±20%	24	0.07	10	7	-	5	-	26	21	
	PRG21BC0R2MM1RA	0.2±20%	6	37.5	750	500	430	-	315	2100	1620	
	PRG21BC0R6MM1RA	0.6±20%	6	12.5	420	285	240	-	180	1160	920	
	PRG21BC1R0MM1RA	1.0±20%	12	15.0	330	220	190	-	138	880	740	
	PRG21BC2R2MM1RA	2.2±20%	16	9.10	220	150	125	-	95	620	500	
	PRG21BC3R3MM1RA	3.3±20%	20	7.58	180	120	100	-	75	500	400	
PRG21BC4R7MM1RA	4.7±20%	30	7.98	155	100	85	-	60	420	330		
PRG21BC6R8MM1RA	6.8±20%	30	5.52	120	80	67	-	50	335	260		
PRG21BB150MB1RK	15±20%	20	1.67	59	40	-	-	-	145	116	-20°C~+60°C	
PRG21BB220MB1RK	22±20%	20	1.14	44	30	-	-	-	115	91		

**Attention:**

This datasheet is downloaded from the website of Murata Manufacturing Co., Ltd. Therefore, its specifications are subject to change or our products in it may be discontinued without advance notice. Please check with our sales representatives or product engineers before ordering.

### 3.2 Time to trip

Time to trip at 25 °C(Typical curve) PRG21\*\*\*\*M\*1RA

- A = PRG21BC0R2MM1RA
- B = PRG21BC0R6MM1RA
- C = PRG21BC1R0MM1RA
- D = PRG21BC2R2MM1RA
- E = PRG21BC3R3MM1RA
- F = PRG21BC4R7MM1RA
- G = PRG21BC6R8MM1RA

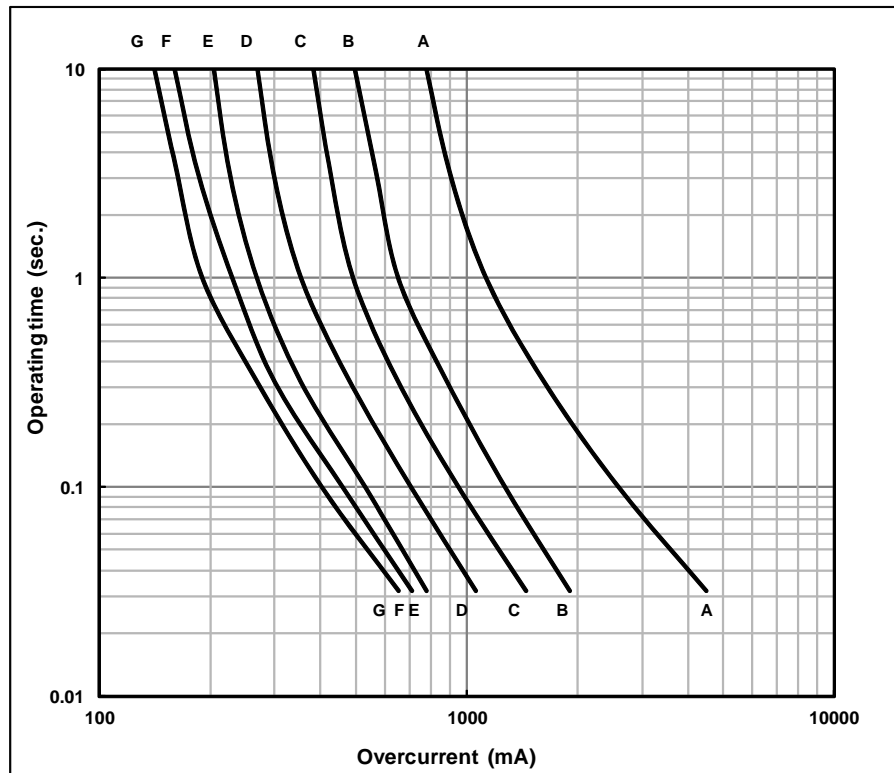

Time to trip at 25 °C(Typical curve) PRG21\*\*\*\*M\*1RK

- A = PRG21BB150MB1RK
- B = PRG21BB220MB1RK

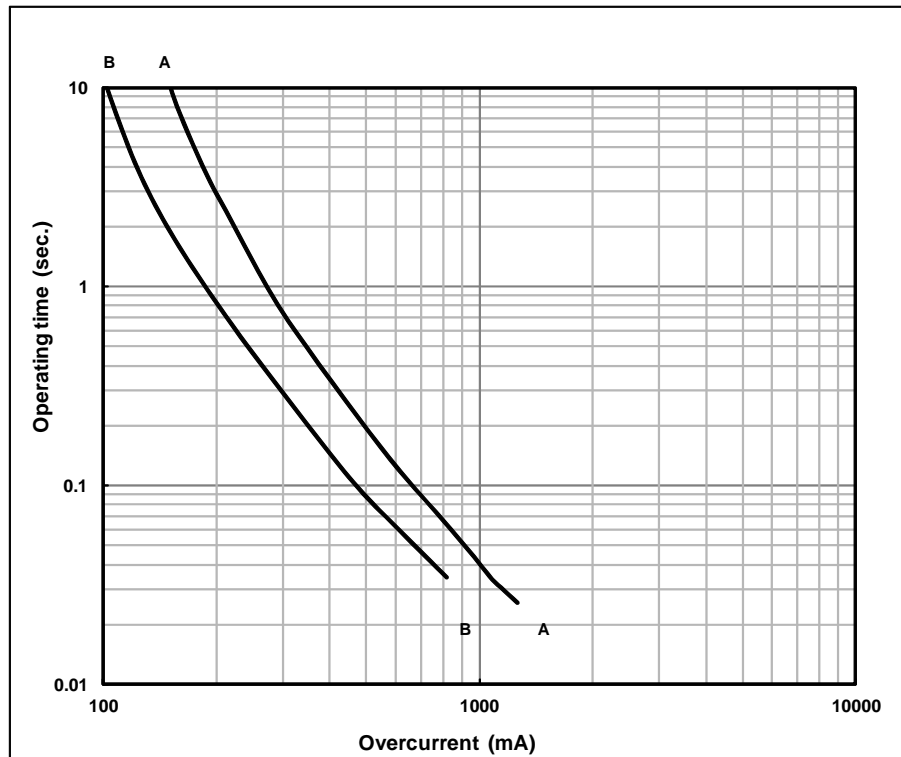

**Attention:**

This datasheet is downloaded from the website of Murata Manufacturing Co., Ltd. Therefore, it's specifications are subject to change or our products in it may be discontinued without advance notice. Please check with our sales representatives or product engineers before ordering.

### 3.3 Operating Time

Time to trip at 25 °C(Typical curve) PRG18\*\*\*\*M\*1RB

- A= PRG18BC1R0MM1RB
- B= PRG18BC2R2MM1RB
- C= PRG18BC3R3MM1RB
- D= PRG18BC4R7MM1RB
- E= PRG18BC6R8MM1RB
- F= PRG18BC100MM1RB
- G= PRG18BC150MM1RB
- H= PRG18BC220MM1RB
- I= PRG18BC330MB1RB
- J= PRG18BB330MB1RB
- K= PRG18BB470MB1RB
- L= PRG18BC470MB1RB
- M= PRG18BC680MB1RB
- N= PRG18BB101MB1RB
- O= PRG18BB221MB1RB
- P= PRG18BB471MB1RB

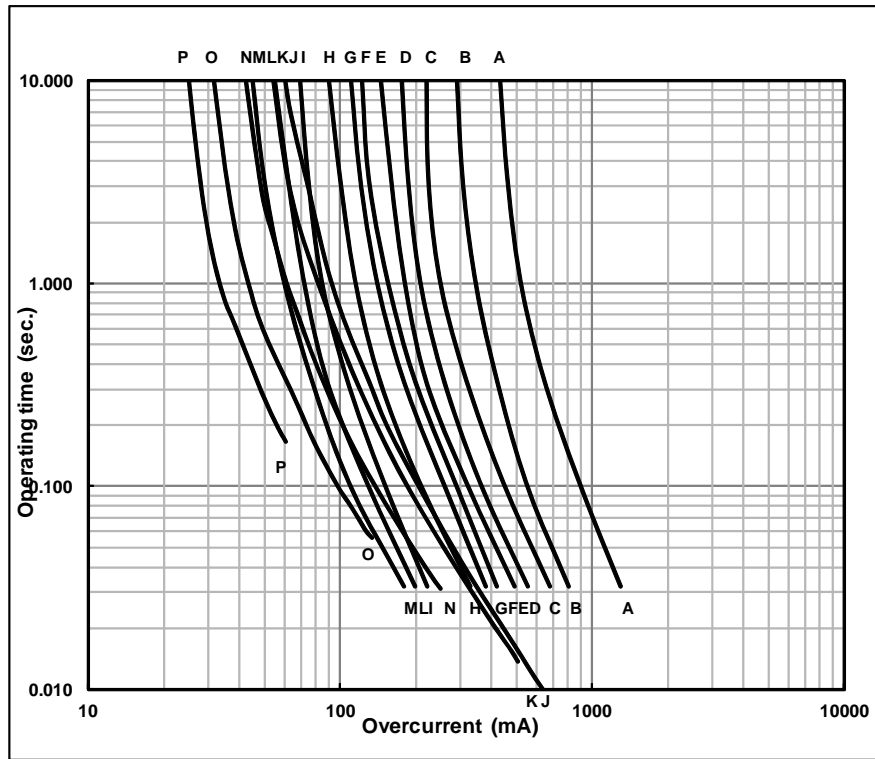

Time to trip at 25 °C(Typical curve) PRG15BC\*\*\*MM1RC

- A= PRG15BC2R2MM1RC
- B= PRG15BC3R3MM1RC
- C= PRG15BC4R7MM1RC
- D= PRG15BC180MM1RC
- E= PRG15BC220MM1RC
- F= PRG15BC330MM1RC
- G= PRG15BC470MM1RC
- H= PRG15BC680MM1RC

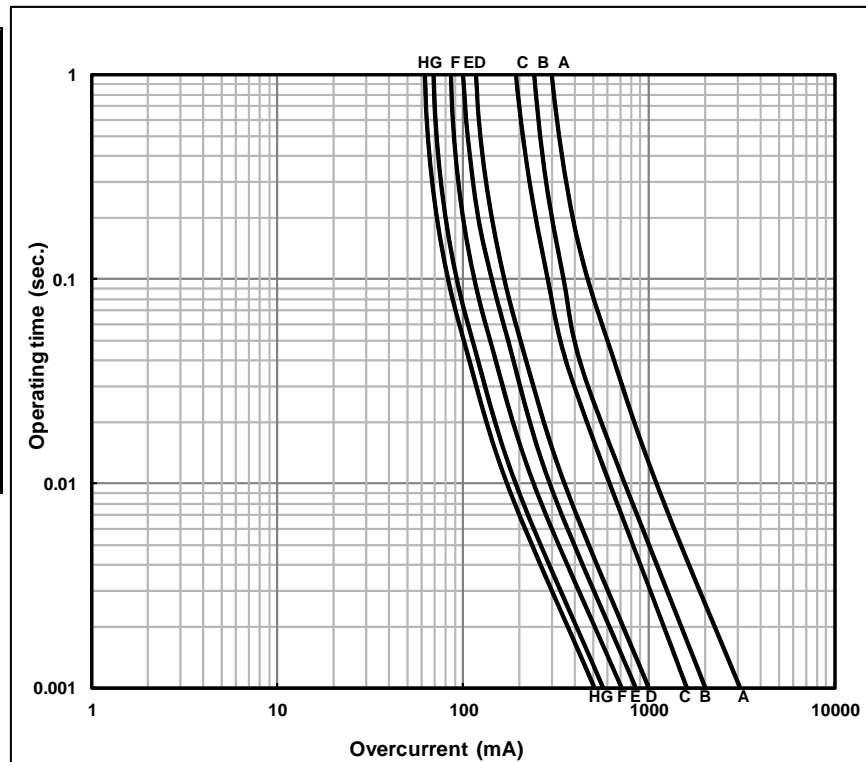

**Attention:**

This datasheet is downloaded from the website of Murata Manufacturing Co., Ltd. Therefore, its specifications are subject to change or our products in it may be discontinued without advance notice. Please check with our sales representatives or product engineers before ordering.

### 3.4 Electrical characteristics

	Item	Specification	Test Condition
3.4.1	Resistance value	The resistance value shall be within the specified tolerance.	After applying max. operating voltage for 3 mins. and leaving for 24 hrs. in 25°C, by 4 wire measuring methods applying current less than 10mA. (by a voltage less than 0.1 VDC.)
3.4.2	Temperature characteristics	The resistance change with temperature typical curve shown in Graph-1.	Resistance value is measured by 4 wire measuring methods applying current less than 10mA. (by a voltage less than 0.1 VDC.)
3.4.3	Withstanding voltage	Without damage	We apply 120% of the max. operating voltage to Posistor® by rising gradually for 180±5 sec. at 25°C. (A protective resistor is to be connected in series, and the inrush current through Posistor® must be limited below max. rated value.)
3.4.4	Operating temp.	-20°C to 85°C	Temperature range with maximum voltage Applied to Posistor®.

### 3.5 Mechanical characteristics

	Item	Specification	Test Condition
3.5.1	Vibration	Normal appearance. Resistance change not exceed ±20%(#)	Reference standard: IEC 60068-2-6 (1995) •Soldered PTC to PCB (##) •Frequency range: 10 to 55 Hz •Amplitude: 1.5mm •Sweep rate: 1octave/min. •Direction: X-Y-Z (3 direction) •Test time: 6hours(2hours for each axis)
3.5.2	Solderability (Other)	Min. 75% electrode is covered with new solder. Resistance change not exceed ±20%(#)	Reference standard: IEC 60068-2-58 (2004) •Solder: Sn-3.0Ag-0.5Cu •Solder temp: 245+/-5°C •Immersion time: 3+/-0.3s •Soaking position: Until a whole electrode is soaked.
3.5.3	Solderability (Reflow)	Normal appearance. Resistance change not exceed ±20%(#)	Reference standard: IEC 60068-2-58 (2004) [Reflow method] •Solder: Sn-3.0Ag-0.5Cu •Preheat: +150 to +180°C, 120+/-5s •Peak temp: 260+/-5°C •Soldering time: ≥220°C, 60 to 90s •Reflow cycle: 1 time •Test board: Grass-Epoxy test board (FR-4) with our standard land size

#### Attention:

This datasheet is downloaded from the website of Murata Manufacturing Co., Ltd.  
Therefore, it's specifications are subject to change or our products in it may be discontinued without advance notice.  
Please check with our sales representatives or product engineers before ordering.

### 3.6 Environmental characteristics

	Item	Specification	Test Condition
3.6.1	Dry Heat	Normal appearance. Resistance change not exceed $\pm 20\%$ (#)	Reference standard: IEC 60068-2-2 (2007) •Soldered PTC to PCB (##) •+85+/-2°C •1000+48/-0 hrs.
3.6.2	Cold		Reference standard: IEC 60068-2-1 (2007) •Soldered PTC to PCB (##) •-20+/-3°C •1000+48/-0 hrs.
3.6.3	Damp heat		Reference standard: IEC 60068-2-67 (1995) •Soldered PTC to PCB (##) •+60+/-2°C, 90+/-5%RH •500+24/-0 hrs.
3.6.4	Thermal shock		Reference standard: IEC 60068-2-14 (2009) [Test Na] •Soldered PTC to PCB (##) •Transport time: <3 min. •Test condition: See below table
3.6.5	High temperature load		Reference standard: IEC 60068-2-2 (2007) •Soldered PTC to PCB (##) •+85+/-2°C •Test condition: See below table

Step	Condition	time
1	-20+/-3°C	30min.
2	+85+/-2°C	30min.

Step	Voltage	time
1	Max. Voltage	1.5hr.
2	OFF	0.5hr.

#The resistance value after the test is measured by 4-terminal method with less than 1mA (DC1.0V), After storage in 25+/-2 °C for 2hrs.

## Above mentioned soldering is done following condition at our side.

- Glass-Epoxy PC board
  - Standard land dimension
  - Standard solder paste
  - Standard solder profile
- Above conditions are mentioned in Notice.

(Note)

Above 7.5 High temperature load is based on Glass-Epoxy PC board which thermal dissipation coefficient of a mounting state is 10mW/°C.

In other condition of 10mW/°C, High temperature load characteristics may change.

#### Attention:

This datasheet is downloaded from the website of Murata Manufacturing Co., Ltd. Therefore, it's specifications are subject to change or our products in it may be discontinued without advance notice. Please check with our sales representatives or product engineers before ordering.



## 4. Measurement direction

### 4.1 Technical performance Characteristic

#### 4.1.1 How to read Protective Threshold

##### For Example

Size [ mm/in.]	Part Number	Hold Current [mA]		Trip Current [mA]		Max. Voltage [ VDC ]	Max. Current [ A ]	Resistance at 25°C [ ohm ]	Operation Temp. [ °C ]
		at 60°C	at 25°C	at 25°C	at -10°C				
2012/0805	PRG21BB220MB1RK	30	44	91	110	20	1.14	22±20%	-20°C~+60°C

#### ■ Protective Threshold Current Range

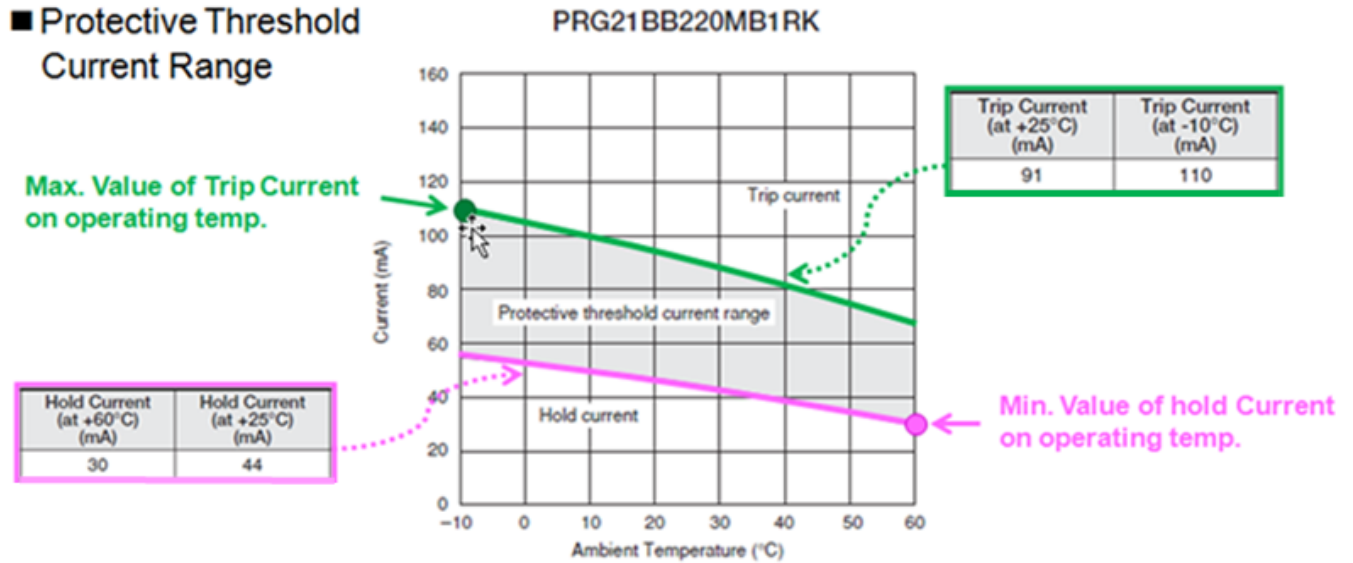

#### 4.1.2 Recommended Circuit

##### For Example

PRG protect circuit from abnormal current caused by short circuit and ground fault.

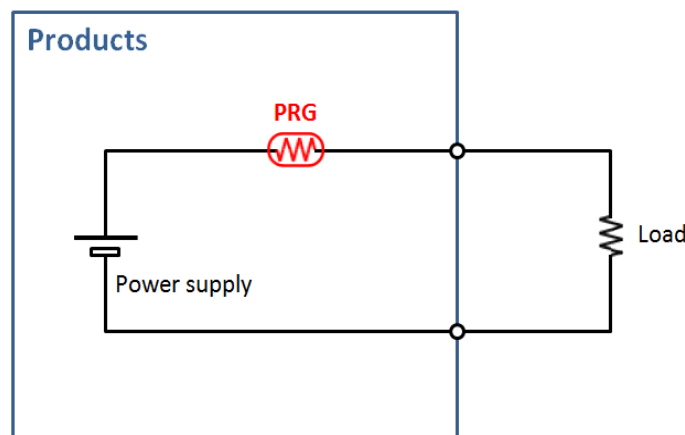

#### Attention:

This datasheet is downloaded from the website of Murata Manufacturing Co., Ltd. Therefore, its specifications are subject to change or our products in it may be discontinued without advance notice. Please check with our sales representatives or product engineers before ordering.

## 5. Dimension, Land Pattern

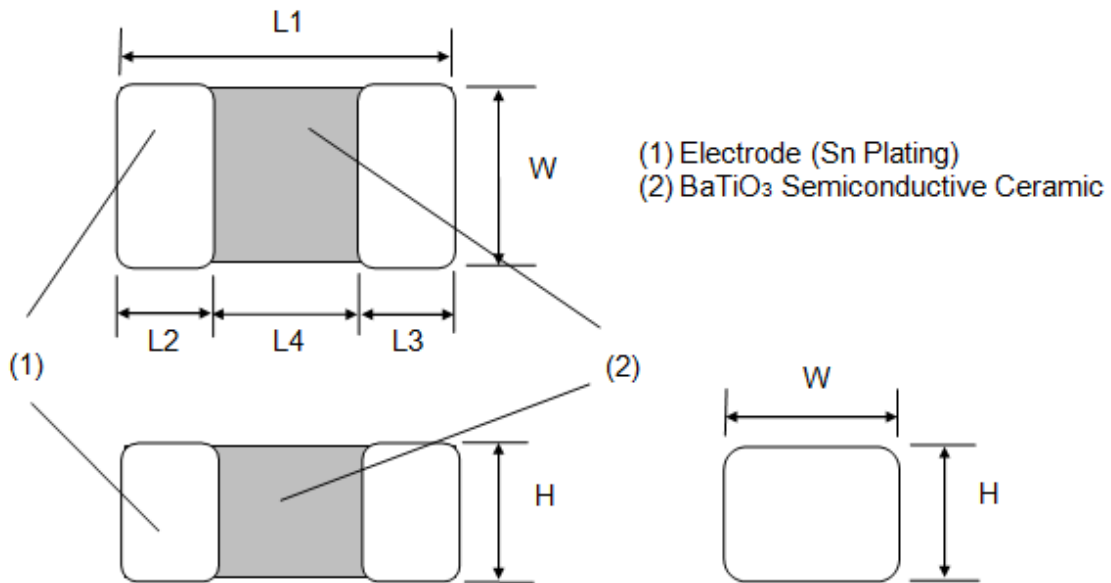

Part Number	Detention(mm)				
	L1	W	H	L2 and L3	L4
PRG15_RC	1.00±0.05	0.5±0.05	0.5±0.05	0.15 to 0.35	-
PRG18_RB	1.60±0.15	0.8±0.15	0.8±0.15	0.1 to 0.6	-
PRG21_RA	2.00±0.20	1.25±0.20	0.90±0.20	Min. 0.2	Min. 0.5
PRG21_RK	2.00±0.20	1.25±0.20	1.25±0.20	Min. 0.2	Min. 0.5

### Attention:

This datasheet is downloaded from the website of Murata Manufacturing Co., Ltd.  
Therefore, it's specifications are subject to change or our products in it may be discontinued without advance notice.  
Please check with our sales representatives or product engineers before ordering.

## 6. Packing

### 6.1 Taping Specification

#### 6.1.1 Dimensions of plastic tape (\*Typical data of PRG21\_RA Series)

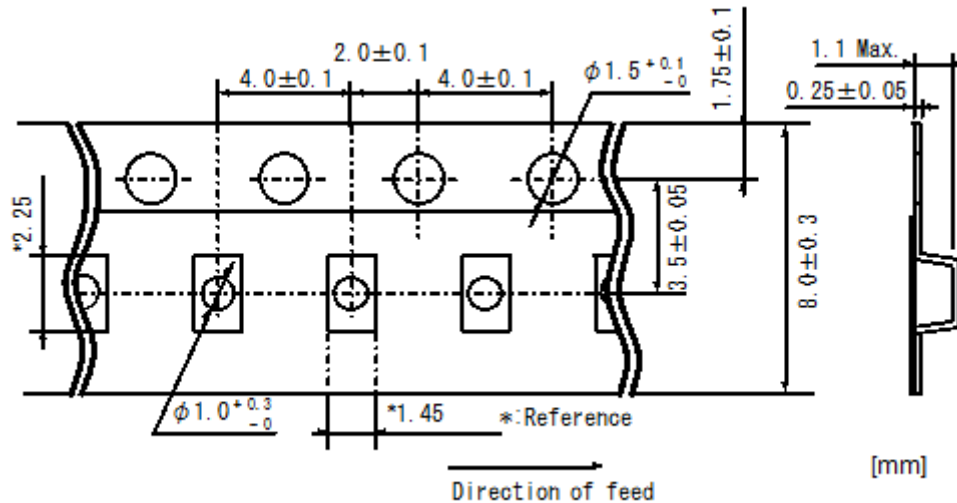

- (1) Products shall be packaged in the each embossed cavity of plastic tape and sealed by cover tape.
- (2) Cover tape have no joints and products shall be packaged and sealed in the cavity of plastic tape, continuously.

#### 6.1.2 Tape strength

- (1) Pull strength of plastic tape and cover tape shall be specified as follows;

Plastic tape	Cover tape
5N minimum	10N minimum

- (2) Peeling force of cover tape

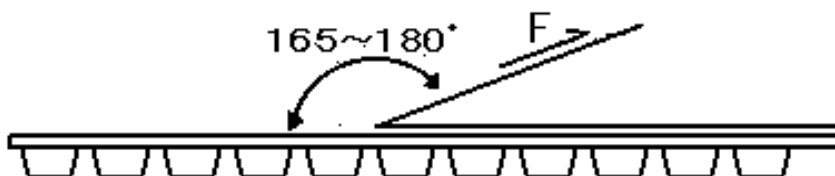

\*1 Peeling angle : 165 to 180 degree against the fixed surface of tape.

\*2 Peeling speed : 300mm/min.

\*3 Peeling force : 0.1 ~ 0.7 N

#### Attention:

This datasheet is downloaded from the website of Murata Manufacturing Co., Ltd. Therefore, it's specifications are subject to change or our products in it may be discontinued without advance notice. Please check with our sales representatives or product engineers before ordering.

6.1.3 Reeling

(1) Quantity (Standard Quantity)

Part Number	Products quantity in a reel
PRG15_RC	10,000 pcs. /reel
PRG18_RB	4,000 pcs. /reel
PRG21_RA	4,000 pcs. /reel
PRG21_RK	3,000 pcs. /reel

(2) A tape in a reel contains Leader unit and Trailer unit where products are not packed.

(See the following figure.)

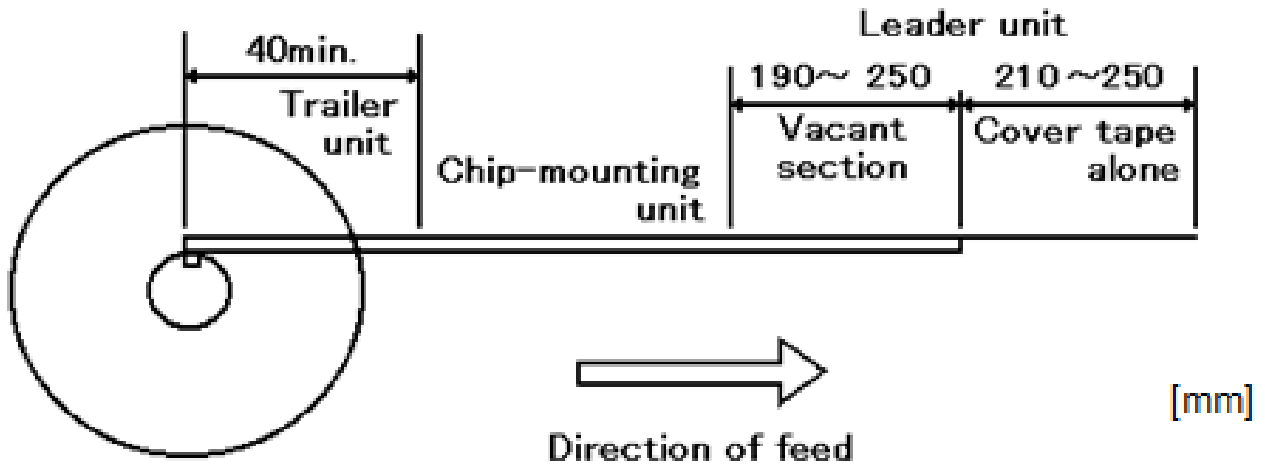

\* The reeling specification above shall not be applied for the order less than Standard Quantity.

(3) The plastic tape and cover tape are not attached at the end of the tape (Vacant section) for a minimum of 5 pitches.

(4) A label shall be attached on the reel.

(MURATA's part number, inspection number and quantity shall be marked on the label.)

(5) Dimensions of reel

**Attention:**

This datasheet is downloaded from the website of Murata Manufacturing Co., Ltd. Therefore, it's specifications are subject to change or our products in it may be discontinued without advance notice. Please check with our sales representatives or product engineers before ordering.

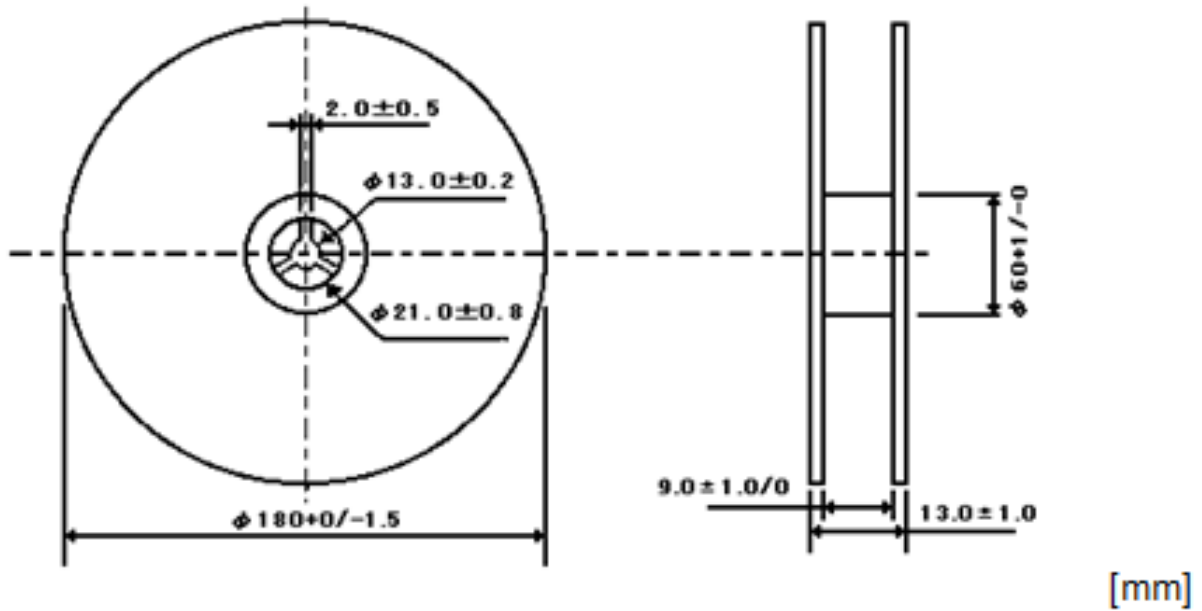

#### 6.1.4 Packing

The reeling shall be packed in a package.

The label shall be attached on the package.

(Customer's name, order number, customer's part number, MURATA's part number and quantity shall be marked on a label.)

#### Attention:

This datasheet is downloaded from the website of Murata Manufacturing Co., Ltd. Therefore, it's specifications are subject to change or our products in it may be discontinued without advance notice. Please check with our sales representatives or product engineers before ordering.

7.  **CAUTION**

### 7.1 Caution

1. This product is designed for application, which is used under ordinary environment. (room temperature, normal humidity, normal pressure) Do not expose this to the following environments, because all these factors can deteriorate the characteristic of this and can cause failure or burn out.

- (1) Corrosive gas or deoxidizing gases (Cl<sub>2</sub>, H<sub>2</sub>S, NH<sub>3</sub>, SOx, NOx etc.)
- (2) Volatile, flammable gas
- (3) Dusty place
- (4) Place in a vacuum, reducing or putting pressure
- (5) Place in splashed water, or high humidity and dewing place
- (6) Salt water, oil, chemical liquid and solvent
- (7) Vibratile place
- (8) Other place equivalent to the above

2. Limitation of Applications

Please contact us before using our products for the under-mentioned applications requiring especially high reliability in order to prevent defects which might directly cause damage to other party's life body or property (listed below).

- (1) Aircraft equipment      (2) Aerospace equipment      (3) Undersea equipment
- (4) Power plant control equipment      (5) Medical equipment
- (6) Transportation equipment (automobiles, trains, ships, etc.)      (7) Traffic signal equipment
- (8) Disaster prevention / Crime prevention equipment      (9) Data-processing equipment
- (10) Applications of similar complexity or with reliability requirements comparable to the applications listed in the above

3. Be sure to provide an appropriate fail-safe function on your product to prevent a second damage that may be caused by the abnormal function or the failure of our product.

### 7.2 Notice

**Notice**

1. Do not apply abnormal voltage/current exceeding the specified maximum value. Because they may deteriorate or destroy PTC element.
2. Use this product within the specified temperature. A higher temperature may deteriorate the characteristic or material.
3. The body of this product is not insulated. Please keep an adequate distance to surrounding components and wiring.

---

#### Attention:

This datasheet is downloaded from the website of Murata Manufacturing Co., Ltd. Therefore, it's specifications are subject to change or our products in it may be discontinued without advance notice. Please check with our sales representatives or product engineers before ordering.

4. Storage conditions

To keep solderability from declining, following storage condition is recommended.

- (1) Condition      Temperature : -10 to +40°C  
                         Humidity      : Less than 75%RH (not dewing condition)
- (2) Term: Please use this POSISTOR within 6 months after shipment by first-in and first-out stocking system.
- (3) Place: Do not store this product in corrosive gas (SOx, Cl etc) or under sunlight.

5. Solder and Flux

(1) Solder Paste

Use Sn:Pb=60:40wt% ,Sn:Pb=63:37wt%, Sn:Ag:Cu=96.5:3.0:0.5wt% or equivalent type of solder paste.

Do not use strong acidic flux (with halide content exceeding 0.2wt%).

Use of the solder containing Zn may reduce adhesive strength.

When you use the solder containing Zn, please contact us in advance.

For your reference, we are using

'63Sn/37Pb RMA9086 90-3-M18', manufactured by Alpha Metals Japan Ltd.,

'96.5Sn/3.0Ag/0.5Cu M705-GRN360-K2-V', manufactured by Senju Metal Industry Co.,LTD.

for any Internal tests of this product.

(2) Flux

Use rosin type flux in soldering process.

If below flux is used, some problems might be caused in the product characteristics and reliability.

Please do not use below flux.

- Strong acidic flux (with halide content exceeding 0.2wt%).
- Water-soluble flux(\*Water-soluble flux can be defined as non rosin type flux including wash-type flux and non-wash-type flux.)

6. For removing the flux after soldering, observe the following points in order to avoid deterioration of the characteristics or any change of the external electrodes quality.

(1) Cleaning Conditions

Solvent	Dipping Cleaning	Ultrasonic Cleaning
2-propanol	Less than 5 min. at room temp. or Less than 2 min. at 40°C max.	Less than 1 min. 20W/L max. Frequency of several 10 kHz to several 100 kHz.

**Attention:**

This datasheet is downloaded from the website of Murata Manufacturing Co., Ltd. Therefore, it's specifications are subject to change or our products in it may be discontinued without advance notice. Please check with our sales representatives or product engineers before ordering.

7. In your mounting process, observe the following points in order to avoid deterioration of the characteristics or destruction of this product. The mounting quality of this product may also be affected by the mounting conditions, shown the points below.

This product is for only reflow soldering. Flow soldering shall not be allowed.

Please mount this product by soldering. When mounted by other methods, such as conductive adhesives, please contact us in advance.

(1) Standard Land Size

Too big land size gives too much solder paste on the land. It may cause destruction of this product, because of the mechanical stress especially in the case of board bending.

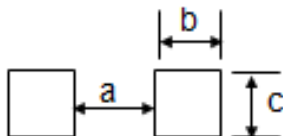

(2) Printing Conditions of Solder Paste

i. Standard thickness of solder paste printing shall be from 0.15 to 0.20 mm.

ii. After soldering, the solder fillet shall be a height from 0.2 mm to the thickness of this product.

(See the figures below.)

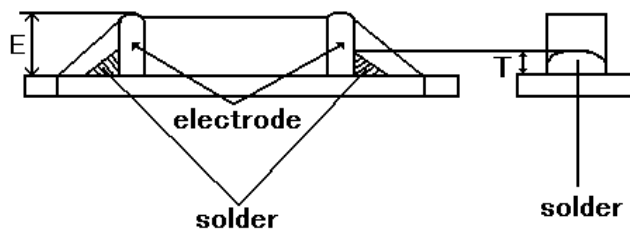

$$0.2\text{mm} \leq T \leq E$$

iii. Too much solder gives too strong mechanical stress to this product, such stress may cause cracking or any mechanical damage. And also, it can destroy the electrical performance of this product.

**Attention:**

This datasheet is downloaded from the website of Murata Manufacturing Co., Ltd. Therefore, it's specifications are subject to change or our products in it may be discontinued without advance notice. Please check with our sales representatives or product engineers before ordering.



(3) Allowable Soldering Temperature and Time

- i. Solder within the temperature and time combinations, indicated by the slanted lines in the following graphs.
- ii. The excessive soldering conditions may cause dissolution of metallization or deterioration of solder-wetting on the external electrode.
- iii. In case of repeated soldering, the total accumulated soldering time should be within the range shown below figure. (For example, Reflow peak temperature : 250°C, twice → The total accumulated soldering time at 250°C is within 20sec.)

<Allowable Reflow Soldering Temp. and Time>

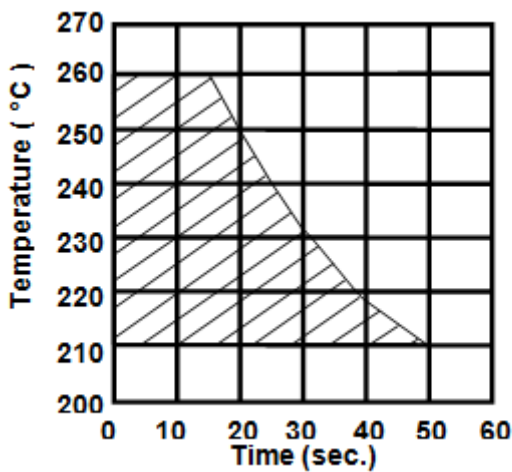

Preheating: 150 +/- 10 °C  
1min. to 2 min.  
Soldering: 240 °C  
20sec.

# : In case of repeated soldering, the total accumulated soldering time should be within the range shown above figure (3).

(4) Standard Temperature Profile for Soldering

- i. Insufficient preheating may cause a crack on ceramic body. Difference between preheating temperature and maximum temperature in the profile shall be 100°C.
- ii. Rapid cooling by dipping in solvent or by other means is not recommended.

<Reflow Soldering Condition>

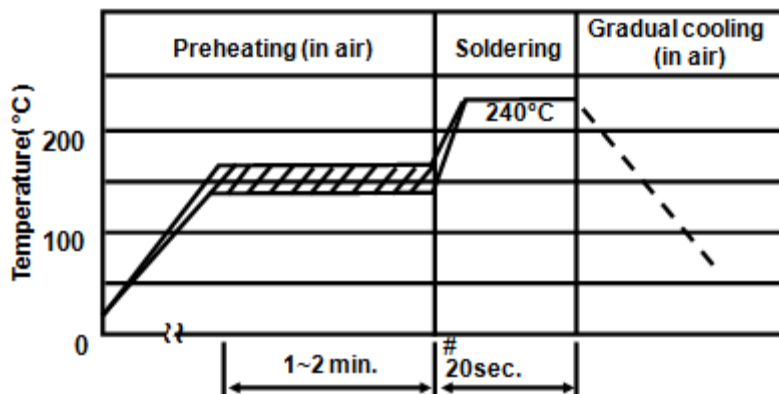

Preheating: 150 +/- 10 °C  
1min. to 2 min.  
Soldering: 240 °C  
20sec.

# : In case of repeated soldering, the total accumulated soldering time should be within the range shown above figure (3).

**Attention:**

This datasheet is downloaded from the website of Murata Manufacturing Co., Ltd. Therefore, it's specifications are subject to change or our products in it may be discontinued without advance notice. Please check with our sales representatives or product engineers before ordering.

(5) There is a fear of unexpected failures (tombstone, insufficient solder-wetting, etc.) in your mounting process, caused by the mounting conditions. Please evaluate if this product is correctly mounted under your mounting conditions.

(6) Conditions with Soldering Iron

When hand soldering by iron is applied, be sure to keep following conditions.

Item	Conditions
Preheating	at 150°C for 1 to 2 minute
Temperature of Iron-tip	350°C max.
Soldering Iron Wattage	30W max.
Diameter of Iron-tip	3mm dia. max.
Soldering Time	5sec. max.
Solder	H60A (Sn:Pb=60:40wt%) type , H63A (Sn:Pb=63:37wt%) type, Sn:Ag:Cu=96.5:3.0:0.5wt% or equivalent type.
Flux	Do not use strong acidic flux (with halide content exceeding 0.2wt%).
Caution	• Do not allow the iron-tip to directly touch the ceramic body. • Preheat the ceramic body and mounting board.

8. Do not give this product a strong press-force nor a mechanical shock.

Because such mechanical forces may cause cracking or chipping of this ceramic product.

9. Rapid cooling or heating during soldering is not recommended.

Such treatment may destroy the element.

10. When this product is operated, temperature of some area may be over 100 to 150°C. Be sure that surrounding parts and inserting material can withstand the temperature. If the surrounding part and material is kept under such condition, they may be deteriorated or may produce harmful gases (Cl<sub>2</sub>, H<sub>2</sub>S, NH<sub>3</sub>, SOX, NOX etc.). And, such harmful gas may deteriorate the element.

11. Do not assemble this product with air-sealing or resin casting. Such sealing may deteriorate the characteristic or destroy PTC element.

12. Location on Printed Circuit Board(PC Board)

<Component Direction>

Locate this product horizontal to the direction in which stress acts.

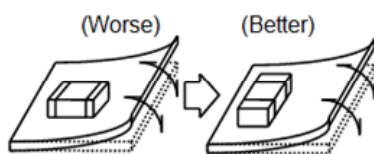

<Mounting Close to Board Separation Line>

Put this product on the PC Board near the Slit, not near the Perforation Holes.

Keep this product on the PC Board away from the Separation Line.

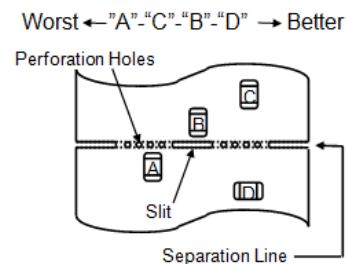

**Attention:**

This datasheet is downloaded from the website of Murata Manufacturing Co., Ltd. Therefore, it's specifications are subject to change or our products in it may be discontinued without advance notice. Please check with our sales representatives or product engineers before ordering.

## 4.2 Note



1. Please make sure that your product has been evaluated in view of your specifications with our product being mounted to your product.
2. You are requested not to use our product deviating from the agreed specifications.
3. We consider it not appropriate to include any terms and condition with regard to the business transaction in the product specification, drawings or other technical documents. Therefore, if your technical documents as above include such terms and conditions such as warranty clause, product liability clause, intellectual property infringement liability clause, or export control clause, they will be deemed to be invalid.

---

### Attention:

This datasheet is downloaded from the website of Murata Manufacturing Co., Ltd.  
Therefore, it's specifications are subject to change or our products in it may be discontinued without advance notice.  
Please check with our sales representatives or product engineers before ordering.