

Overview

The SMR Series is a metallized polyphenylene sulfide film capacitor with vacuum-evaporated aluminum electrodes. Radial leads of tinned wire are electrically welded to the contact metal layer on the ends of the capacitor winding. The capacitor is encapsulated in self-extinguishing material meeting the requirements of UL 94 V-0.

Applications

Typical applications include automotive and other applications with high ambient temperatures, as well as those requiring high stability and low losses. The capacitor offers excellent sound quality in audio applications.

Benefits

- Voltage range: 50 – 400 VDC, 30 – 200 VAC
- Capacitance range: 0.001 – 22 μ F
- Lead spacing: 5 – 27.5 mm
- Capacitance tolerance: \pm 10%, \pm 20%, \pm 2.5% and \pm 5% on request
- Climatic category: 55/150/56, IEC 60068-1
- Tape & Reel packaging in accordance with IEC 60286-2
- RoHS compliant and lead-free terminations
- Category temperature range -55 to +150°C
- Rated temperature +125°C

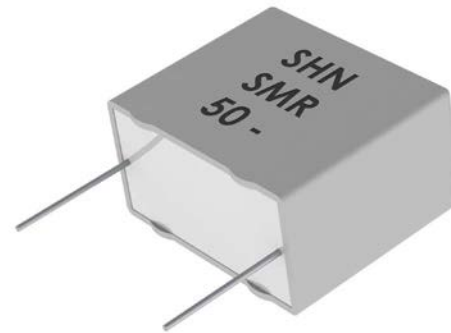

Legacy Part Number System

SMR	5	104	K	50	J01	L4	BULK
Series	Lead Spacing (mm)	Capacitance Code (pF)	Capacitance Tolerance	Rated Voltage (VDC)	Size Code	Lead Length	Packaging
Metallized PPS	5 = 5.0 7.5 = 7.5 10 = 10.0 15 = 15.0 22.5 = 22.5 27.5 = 27.5	First two digits indicate the two most significant digits of the capacitance value in picofarads. The third digit is the number of following zeros.	H = \pm 2.5% J = \pm 5% K = \pm 10% M = \pm 20%	50 = 50 63 = 63 100 = 100 250 = 250 400 = 400	See Dimension Table	Letter "L" followed by lead length in mm	See Ordering Options Table

New KEMET Part Number System

F	211	J	F	104	K	050	C
Capacitor Class	Series	Lead Spacing (mm)	Size Code	Capacitance Code (pF)	Capacitance Tolerance	Rated Voltage (VDC)	Packaging
F = Film	Metallized PPS	J = 5.0 K = 7.5 A = 10.0 B = 15.0 D = 22.5 F = 27.5	See Dimension Table	First two digits indicate the two most significant digits of the capacitance value in picofarads. The third digit is the number of following zeros.	R = \pm 2.5% J = \pm 5% K = \pm 10% M = \pm 20%	050 = 50 063 = 63 100 = 100 250 = 250 400 = 400	See Ordering Options Table

Ordering Options Table

Lead Spacing Nominal (mm)	Type of Leads and Packaging	Lead Length (mm)	KEMET Lead and Packaging Code	Legacy Lead and Packaging Code
5	Standard lead and packaging options:			
	Bulk (bag) – short leads	4.0 +1/-0	C	L4BULK
	Bulk (bag) – straight leads	16.5 ±0.5	ALG5C	L16.5CBULK
	Tape & Reel (standard reel)	H ₀ = 18.5 ±0.5	L	L16.5TR18
	Other lead and packaging options:			
	Ammo pack	H ₀ = 18.5 ±0.5	R	L16.5TA18
	Tape & Reel (large reel)	H ₀ = 18.5 ±0.5	P	L16.5LR18
7.5	Standard lead and packaging options:			
	Bulk (bag) – short leads	4.0 +1/-0	C	L4BULK
	Bulk (bag) – straight leads	16.5 ±0.5	ALG5C	L16.5CBULK
	Tape & Reel (standard reel)	H ₀ = 18.5 ±0.5	L	L16.5TR18
	Other lead and packaging options:			
	Ammo pack	H ₀ = 18.5 ±0.5	R	L16.5TA18
	Tape & Reel (large reel)	H ₀ = 18.5 ±0.5	P	L16.5LR18
	Ammo pack (P0 = 15mm)	H ₀ = 18.5 ±0.5	XLAF1	XA18
10	Standard lead and packaging options:			
	Bulk (bag) – short leads	4.0 +1/-0	C	L4BULK
	Bulk (bag) – straight leads	16.5 ±0.5	ALG5C	L16.5CBULK
	Tape & Reel (standard reel)	H ₀ = 18.5 ±0.5	L	L16.5TR18
	Other lead and packaging options:			
	Tape & Reel (large reel)	H ₀ = 18.5 ±0.5	P	L16.5LR18
Native 10 formed to 7.5	Ammo pack	H ₀ = 18.5 ±0.5	XLAF1	L25.0CXA18

Ordering Options Table cont'd

Lead Spacing Nominal (mm)	Type of Leads and Packaging	Lead Length (mm)	KEMET Lead and Packaging Code	Legacy Lead and Packaging Code
15	Standard lead and packaging options:			
	Bulk (bag) – short leads	4.0 +1/-0	C	L4BULK
	Bulk (bag) – straight leads	16.5 ±0.5	ALG5C	L16.5CBULK
	Tape & Reel (standard reel)	H ₀ = 18.5 ±0.5	L	L16.5TR18
	Other lead and packaging options:			
	Tape & Reel (large reel)	H ₀ = 18.5 ±0.5	P	L16.5LR18
Native 15 formed to 7.5	Ammo pack	H ₀ = 18.5 ±0.5	XLAF1	L25.0CXA18
	Tape & Reel (standard reel)	H ₀ = 18.5 ±0.5	XLTF1	L25.0CXR18
22.5	Standard lead and packaging options:			
	Bulk (tray) - short leads	4.0 +1/-0	C	L4TRAY
	Tape & Reel (standard reel)	H ₀ = 18.5 ±0.5	L	R17T0
	Tape & Reel (large reel)	H ₀ = 18.5 ±0.5	P	R17T1
27.5	Standard lead and packaging options:			
	Bulk (tray) - short leads	4.0 +1/-0	C	L4TRAY
	Tape & Reel (large reel)	H ₀ = 18.5 ±0.5	P	R17T1

Dimensions – Millimeters

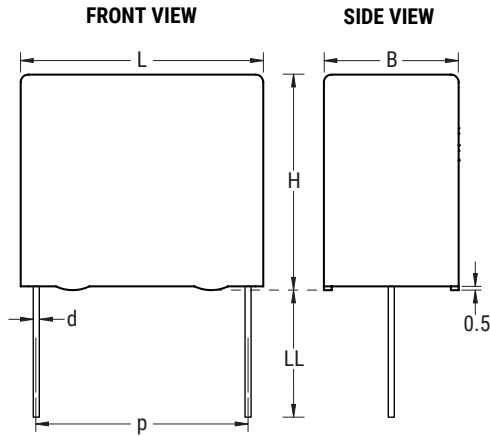

KEMET Size Code	Legacy Size Code	p		B		H		L		d	
		Nominal	Tolerance	Nominal	Tolerance	Nominal	Tolerance	Nominal	Tolerance	Nominal	Tolerance
JF	J01	5.0	±0.4	2.5	Maximum	6.5	Maximum	7.2	Maximum	0.5	±0.05
JJ	J02	5.0	±0.4	3.5	Maximum	8.0	Maximum	7.2	Maximum	0.5	±0.05
JL	J03	5.0	±0.4	4.5	Maximum	9.0	Maximum	7.2	Maximum	0.5	±0.05
JQ	J04	5.0	±0.4	5.0	Maximum	10.0	Maximum	7.2	Maximum	0.5	±0.05
JT	J05	5.0	±0.4	6.0	Maximum	11.0	Maximum	7.2	Maximum	0.5	±0.05
JU	J06	5.0	±0.4	7.2	Maximum	13.0	Maximum	7.2	Maximum	0.5	±0.05
KG	K01	7.5	±0.4	4.0	Maximum	8.0	Maximum	10.0	Maximum	0.6	±0.05
KK	K03	7.5	±0.4	5.0	Maximum	11.0	Maximum	10.0	Maximum	0.6	±0.05
KM	K04	7.5	±0.4	6.0	Maximum	12.0	Maximum	10.5	Maximum	0.6	±0.05
AG	A01	10.0	±0.4	4.0	Maximum	9.0	Maximum	13.0	Maximum	0.6	±0.05
AH	A02	10.0	±0.4	4.5	Maximum	10.5	Maximum	13.0	Maximum	0.6	±0.05
AK	A03	10.0	±0.4	5.0	Maximum	11.0	Maximum	13.0	Maximum	0.6	±0.05
AP	A04	10.0	±0.4	6.0	Maximum	12.0	Maximum	13.0	Maximum	0.6	±0.05
BD	B04	15.0	±0.4	5.5	Maximum	10.5	Maximum	18.0	Maximum	0.8	±0.05
BE	B05	15.0	±0.4	5.5	Maximum	12.5	Maximum	18.0	Maximum	0.8	±0.05
BL	B06	15.0	±0.4	7.5	Maximum	14.5	Maximum	18.0	Maximum	0.8	±0.05
BJ	B10	15.0	±0.4	6.5	Maximum	12.5	Maximum	18.0	Maximum	0.8	±0.05
BQ	B11	15.0	±0.4	8.5	Maximum	16.0	Maximum	18.0	Maximum	0.8	±0.05
BM	B12	15.0	±0.4	8.0	Maximum	15.0	Maximum	18.0	Maximum	0.8	±0.05
BV	B14	15.0	±0.4	9.5	Maximum	17.5	Maximum	18.0	Maximum	0.8	±0.05
DD	D13	22.5	±0.4	6.5	Maximum	14.5	Maximum	26.0	Maximum	0.8	±0.05
DH	D14	22.5	±0.4	8.0	Maximum	16.0	Maximum	26.0	Maximum	0.8	±0.05
DM	D15	22.5	±0.4	9.0	Maximum	18.5	Maximum	26.0	Maximum	0.8	±0.05
DT	D16	22.5	±0.4	11.0	Maximum	21.5	Maximum	26.0	Maximum	0.8	±0.05
DF	D17	22.5	±0.4	7.0	Maximum	16.5	Maximum	26.0	Maximum	0.8	±0.05
DR	D18	22.5	±0.4	10.5	Maximum	19.0	Maximum	26.0	Maximum	0.8	±0.05
FE	F11	27.5	±0.4	10.5	Maximum	20.5	Maximum	31.5	Maximum	0.8	±0.05
FG	F12	27.5	±0.4	11.5	Maximum	22.5	Maximum	31.5	Maximum	0.8	±0.05
FM	F13	27.5	±0.4	14.5	Maximum	24.5	Maximum	31.5	Maximum	0.8	±0.05
FR	F14	27.5	±0.4	17.5	Maximum	28.0	Maximum	31.5	Maximum	0.8	±0.05

Note: See Ordering Options Table for lead length (LL) options.

Performance Characteristics

Rated voltage V_R (VDC)	50	63	100	250	400
Rated voltage V_R (VAC)	30	40	63	160	200
Capacitance range (μF)	0.001 – 22	0.001 – 22	0.001 – 12	0.001 – 3.9	0.001 – 1.8
Capacitance tolerance	$\pm 10\%$, $\pm 20\%$, $\pm 2.5\%$ and $\pm 5\%$ on request				
Temperature range	-55 to +150°C				
Rated temperature	+125°C				
Voltage derating	From +125°C, the voltage derating is 2%/°C				
Climatic category	IEC 60068-1, 55/150/56				
	DIN 40040, FKD				
Test voltage	$1.6 \times V_R$ for 2 seconds				
Reliability	Operational life > 200,000 hours				
	Failure rate < 3 FIT, T = +40°C, V = $0.5 \times V_R$				
	Failure criteria according to DIN 44122				
Capacitance drift	Maximum 0.3% after a two year storage period at a temperature of +10° to +40°C and a relative humidity of 40 to 60%				
Insulation resistance	Measured at +20°C, according to IEC 60384-1				
	Minimum Values Between Terminals				
		$C \leq 0.33 \mu\text{F}$		$C > 0.33 \mu\text{F}$	
	$V_R \leq 100 \text{ V}$	15,000 M Ω		5,000 M $\Omega \cdot \mu\text{F}$	
	$V_R > 100 \text{ V}$	30,000 M Ω		10,000 M $\Omega \cdot \mu\text{F}$	
Dissipation factor	Maximum Values at +23°C				
Lead spacing		$C \leq 0.1 \mu\text{F}$	$0.1 \mu\text{F} < C \leq 1.0 \mu\text{F}$	$C > 1.0 \mu\text{F}$	
SMR 5	1 kHz	0.15%	0.15%	0.15%	
	10 kHz	0.25%	0.25%	0.35%	
	100 kHz	0.50%	0.60%		
SMR 7.5 to 27.5	1 kHz	0.15%	0.15%	0.15%	
	10 kHz	0.25%	0.25%		
	100 kHz	0.60%			

Derating of V_{rms} vs. Frequency, +100°C Ambient Temperature & 20°C Internal Heating, Typical Values

Lead spacing 5.0 mm



Derating of V_{rms} vs. Frequency, +100°C Ambient Temperature & 20°C Internal Heating, Typical Values (cont'd)

Lead spacing 7.5 – 27.5 mm

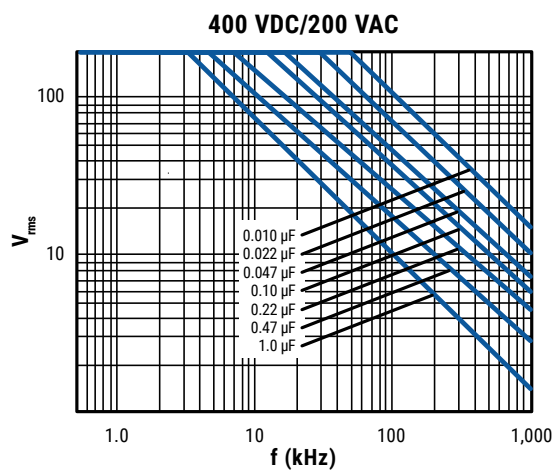
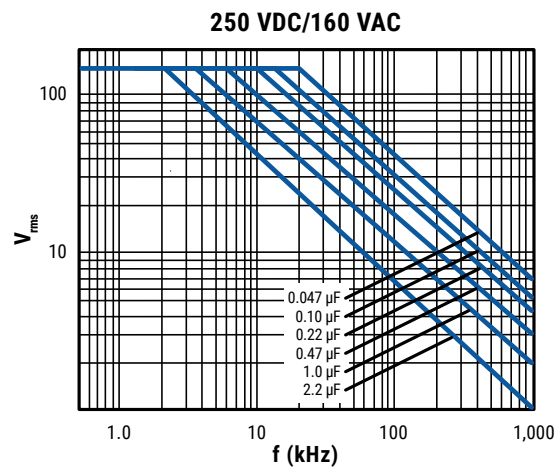
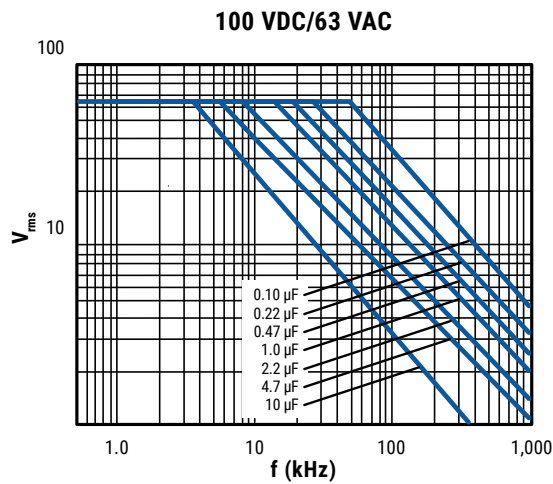
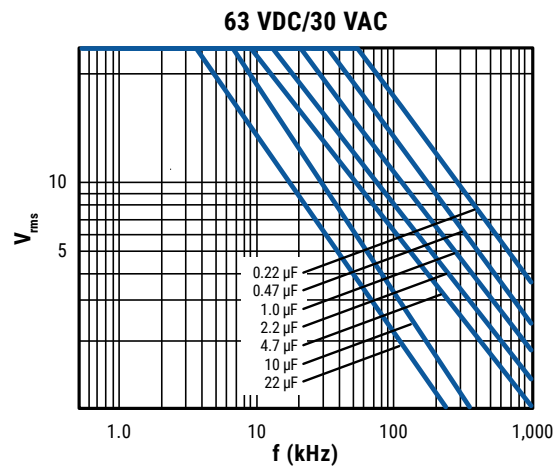
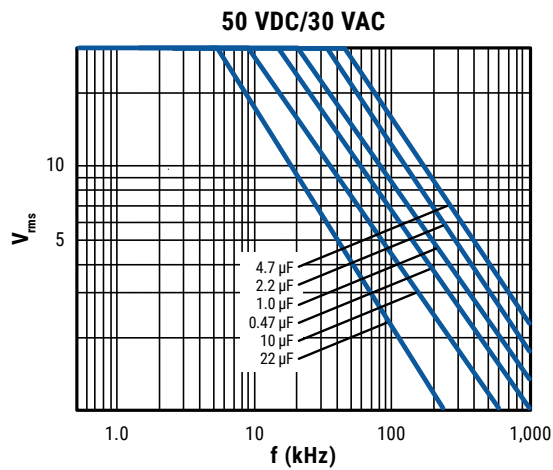

Environmental Test Data

Damp Heat Test	
Test Conditions	T = +40°C, RH = 93%, t = 56 days
Test Criteria	$\Delta C/C \leq \pm 3\%$
	$\Delta \tan\delta \leq 0.0025$ (1 kHz)
	IR after test 0.5 x IR minimum
Endurance Test	
Test Conditions	T = +125°C, V = 1.25 x (0.5 x V _R)
Test Criteria	t = 2,000 hours
	$\Delta C/C \leq \pm 3\%$
	$\Delta \tan\delta \leq 0.002$ (1 kHz), C > 1 μF
	$\Delta \tan\delta \leq 0.003$ (10 kHz), C ≤ 1 μF
	IR after test 0.5 x IR minimum

Environmental Compliance

All KEMET PPS capacitors are RoHS compliant.

Table 1 – Ratings & Part Number Reference

VDC	VAC	Capacitance Value (µF)	Size Code (New/Legacy)	Maximum Dimensions in mm			Lead Spacing (p)	dV/dt (V/µs)	New KEMET Part Number	Legacy Part Number
				B	H	L				
50	30	0.001	JF/J01	2.5	6.5	7.2	5	40	F211JF102(1)050(2)	SMR5102(3)50J01(2)
50	30	0.0012	JF/J01	2.5	6.5	7.2	5	40	F211JF122(1)050(2)	SMR5122(3)50J01(2)
50	30	0.0015	JF/J01	2.5	6.5	7.2	5	40	F211JF152(1)050(2)	SMR5152(3)50J01(2)
50	30	0.0018	JF/J01	2.5	6.5	7.2	5	40	F211JF182(1)050(2)	SMR5182(3)50J01(2)
50	30	0.0022	JF/J01	2.5	6.5	7.2	5	40	F211JF222(1)050(2)	SMR5222(3)50J01(2)
50	30	0.0027	JF/J01	2.5	6.5	7.2	5	40	F211JF272(1)050(2)	SMR5272(3)50J01(2)
50	30	0.0033	JF/J01	2.5	6.5	7.2	5	40	F211JF332(1)050(2)	SMR5332(3)50J01(2)
50	30	0.0039	JF/J01	2.5	6.5	7.2	5	40	F211JF392(1)050(2)	SMR5392(3)50J01(2)
50	30	0.0047	JF/J01	2.5	6.5	7.2	5	20	F211JF472(1)050(2)	SMR5472(3)50J01(2)
50	30	0.0056	JF/J01	2.5	6.5	7.2	5	20	F211JF562(1)050(2)	SMR5562(3)50J01(2)
50	30	0.0068	JF/J01	2.5	6.5	7.2	5	20	F211JF682(1)050(2)	SMR5682(3)50J01(2)
50	30	0.0082	JF/J01	2.5	6.5	7.2	5	20	F211JF822(1)050(2)	SMR5822(3)50J01(2)
50	30	0.01	JF/J01	2.5	6.5	7.2	5	20	F211JF103(1)050(2)	SMR5103(3)50J01(2)
50	30	0.012	JF/J01	2.5	6.5	7.2	5	15	F211JF123(1)050(2)	SMR5123(3)50J01(2)
50	30	0.015	JF/J01	2.5	6.5	7.2	5	15	F211JF153(1)050(2)	SMR5153(3)50J01(2)
50	30	0.018	JF/J01	2.5	6.5	7.2	5	15	F211JF183(1)050(2)	SMR5183(3)50J01(2)
50	30	0.022	JF/J01	2.5	6.5	7.2	5	15	F211JF223(1)050(2)	SMR5223(3)50J01(2)
50	30	0.027	JF/J01	2.5	6.5	7.2	5	15	F211JF273(1)050(2)	SMR5273(3)50J01(2)
50	30	0.033	JF/J01	2.5	6.5	7.2	5	15	F211JF333(1)050(2)	SMR5333(3)50J01(2)
50	30	0.039	JF/J01	2.5	6.5	7.2	5	15	F211JF393(1)050(2)	SMR5393(3)50J01(2)
50	30	0.047	JF/J01	2.5	6.5	7.2	5	6	F211JF473(1)050(2)	SMR5473(3)50J01(2)
50	30	0.056	JF/J01	2.5	6.5	7.2	5	6	F211JF563(1)050(2)	SMR5563(3)50J01(2)
50	30	0.068	JF/J01	2.5	6.5	7.2	5	6	F211JF683(1)050(2)	SMR5683(3)50J01(2)
50	30	0.082	JF/J01	2.5	6.5	7.2	5	6	F211JF823(1)050(2)	SMR5823(3)50J01(2)
50	30	0.1	JF/J01	2.5	6.5	7.2	5	6	F211JF104(1)050(2)	SMR5104(3)50J01(2)
50	30	0.12	JF/J01	2.5	6.5	7.2	5	6	F211JF124(1)050(2)	SMR5124(3)50J01(2)
50	30	0.15	JJ/J02	3.5	8	7.2	5	6	F211JJ154(1)050(2)	SMR5154(3)50J02(2)
50	30	0.18	JJ/J02	3.5	8	7.2	5	6	F211JJ184(1)050(2)	SMR5184(3)50J02(2)
50	30	0.22	JJ/J02	3.5	8	7.2	5	6	F211JJ224(1)050(2)	SMR5224(3)50J02(2)
50	30	0.27	JJ/J02	3.5	8	7.2	5	6	F211JJ274(1)050(2)	SMR5274(3)50J02(2)
50	30	0.33	JL/J03	4.5	9	7.2	5	6	F211JL334(1)050(2)	SMR5334(3)50J03(2)
50	30	0.39	JL/J03	4.5	9	7.2	5	6	F211JL394(1)050(2)	SMR5394(3)50J03(2)
50	30	0.47	JQ/J04	5	10	7.2	5	6	F211JQ474(1)050(2)	SMR5474(3)50J04(2)
50	30	0.56	JQ/J04	5	10	7.2	5	6	F211JQ564(1)050(2)	SMR5564(3)50J04(2)
50	30	0.68	JT/J05	6	11	7.2	5	6	F211JT684(1)050(2)	SMR5684(3)50J05(2)
50	30	0.82	JT/J05	6	11	7.2	5	6	F211JT824(1)050(2)	SMR5824(3)50J05(2)
50	30	1	JU/J06	7.2	13	7.2	5	6	F211JU105(1)050(2)	SMR5105(3)50J06(2)
50	30	1.2	JU/J06	7.2	13	7.2	5	6	F211JU125(1)050(2)	SMR5125(3)50J06(2)
50	30	0.001	KG/K01	4	8	10	7.5	30	F211KG102(1)050(2)	SMR7.5102(3)50K01(2)
50	30	0.0012	KG/K01	4	8	10	7.5	30	F211KG122(1)050(2)	SMR7.5122(3)50K01(2)
50	30	0.0015	KG/K01	4	8	10	7.5	30	F211KG152(1)050(2)	SMR7.5152(3)50K01(2)
50	30	0.0018	KG/K01	4	8	10	7.5	30	F211KG182(1)050(2)	SMR7.5182(3)50K01(2)
50	30	0.0022	KG/K01	4	8	10	7.5	30	F211KG222(1)050(2)	SMR7.5222(3)50K01(2)
50	30	0.0027	KG/K01	4	8	10	7.5	30	F211KG272(1)050(2)	SMR7.5272(3)50K01(2)
50	30	0.0033	KG/K01	4	8	10	7.5	30	F211KG332(1)050(2)	SMR7.5332(3)50K01(2)
50	30	0.0039	KG/K01	4	8	10	7.5	30	F211KG392(1)050(2)	SMR7.5392(3)50K01(2)
50	30	0.0047	KG/K01	4	8	10	7.5	30	F211KG472(1)050(2)	SMR7.5472(3)50K01(2)
50	30	0.0056	KG/K01	4	8	10	7.5	30	F211KG562(1)050(2)	SMR7.5562(3)50K01(2)
50	30	0.0068	KG/K01	4	8	10	7.5	30	F211KG682(1)050(2)	SMR7.5682(3)50K01(2)
50	30	0.0082	KG/K01	4	8	10	7.5	30	F211KG822(1)050(2)	SMR7.5822(3)50K01(2)
50	30	0.01	KG/K01	4	8	10	7.5	30	F211KG103(1)050(2)	SMR7.5103(3)50K01(2)
50	30	0.012	KG/K01	4	8	10	7.5	30	F211KG123(1)050(2)	SMR7.5123(3)50K01(2)
50	30	0.015	KG/K01	4	8	10	7.5	30	F211KG153(1)050(2)	SMR7.5153(3)50K01(2)
50	30	0.018	KG/K01	4	8	10	7.5	30	F211KG183(1)050(2)	SMR7.5183(3)50K01(2)
50	30	0.022	KG/K01	4	8	10	7.5	30	F211KG223(1)050(2)	SMR7.5223(3)50K01(2)
50	30	0.027	KG/K01	4	8	10	7.5	20	F211KG273(1)050(2)	SMR7.5273(3)50K01(2)
VDC	VAC	Capacitance Value (µF)	Size Code (New/Legacy)	B (mm)	H (mm)	L (mm)	Lead Spacing (p)	dV/dt (V/µs)	New KEMET Part Number	Legacy Part Number

(1) R = ±2.5%, J = ±5%, K = ±10%, M = ±20%
 (2) Insert lead and packaging code. See Ordering Options Table for available options.
 (3) H = ±2.5%, J = ±5%, K = ±10%, M = ±20%

Table 1 – Ratings & Part Number Reference cont'd

VDC	VAC	Capacitance Value (µF)	Size Code (New/Legacy)	Maximum Dimensions in mm			Lead Spacing (p)	dV/dt (V/µs)	New KEMET Part Number	Legacy Part Number
				B	H	L				
50	30	0.033	KG/K01	4	8	10	7.5	20	F211KG333(1)050(2)	SMR7.5333(3)50K01(2)
50	30	0.039	KG/K01	4	8	10	7.5	20	F211KG393(1)050(2)	SMR7.5393(3)50K01(2)
50	30	0.047	KG/K01	4	8	10	7.5	20	F211KG473(1)050(2)	SMR7.5473(3)50K01(2)
50	30	0.056	KG/K01	4	8	10	7.5	15	F211KG563(1)050(2)	SMR7.5563(3)50K01(2)
50	30	0.068	KG/K01	4	8	10	7.5	15	F211KG683(1)050(2)	SMR7.5683(3)50K01(2)
50	30	0.082	KG/K01	4	8	10	7.5	15	F211KG823(1)050(2)	SMR7.5823(3)50K01(2)
50	30	0.1	KG/K01	4	8	10	7.5	15	F211KG104(1)050(2)	SMR7.5104(3)50K01(2)
50	30	0.12	KG/K01	4	8	10	7.5	15	F211KG124(1)050(2)	SMR7.5124(3)50K01(2)
50	30	0.15	KG/K01	4	8	10	7.5	10	F211KG154(1)050(2)	SMR7.5154(3)50K01(2)
50	30	0.18	KG/K01	4	8	10	7.5	10	F211KG184(1)050(2)	SMR7.5184(3)50K01(2)
50	30	0.22	KG/K01	4	8	10	7.5	10	F211KG224(1)050(2)	SMR7.5224(3)50K01(2)
50	30	0.27	KG/K01	4	8	10	7.5	10	F211KG274(1)050(2)	SMR7.5274(3)50K01(2)
50	30	0.33	KG/K01	4	8	10	7.5	10	F211KG334(1)050(2)	SMR7.5334(3)50K01(2)
50	30	0.39	KG/K01	4	8	10	7.5	10	F211KG394(1)050(2)	SMR7.5394(3)50K01(2)
50	30	0.47	KK/K03	5	11	10	7.5	10	F211KK474(1)050(2)	SMR7.5474(3)50K03(2)
50	30	0.56	KK/K03	5	11	10	7.5	10	F211KK564(1)050(2)	SMR7.5564(3)50K03(2)
50	30	0.68	KK/K03	5	11	10	7.5	10	F211KK684(1)050(2)	SMR7.5684(3)50K03(2)
50	30	0.82	KK/K03	5	11	10	7.5	10	F211KK824(1)050(2)	SMR7.5824(3)50K03(2)
50	30	1	KM/K04	6	12	10.5	7.5	10	F211KM105(1)050(2)	SMR7.5105(3)50K04(2)
50	30	1.2	KM/K04	6	12	10.5	7.5	10	F211KM125(1)050(2)	SMR7.5125(3)50K04(2)
50	30	0.0027	AG/A01	4	9	13	10	25	F211AG272(1)050(2)	SMR10272(3)50A01(2)
50	30	0.0033	AG/A01	4	9	13	10	25	F211AG332(1)050(2)	SMR10332(3)50A01(2)
50	30	0.0039	AG/A01	4	9	13	10	25	F211AG392(1)050(2)	SMR10392(3)50A01(2)
50	30	0.0047	AG/A01	4	9	13	10	25	F211AG472(1)050(2)	SMR10472(3)50A01(2)
50	30	0.0056	AG/A01	4	9	13	10	25	F211AG562(1)050(2)	SMR10562(3)50A01(2)
50	30	0.0068	AG/A01	4	9	13	10	25	F211AG682(1)050(2)	SMR10682(3)50A01(2)
50	30	0.0082	AG/A01	4	9	13	10	25	F211AG822(1)050(2)	SMR10822(3)50A01(2)
50	30	0.01	AG/A01	4	9	13	10	25	F211AG103(1)050(2)	SMR10103(3)50A01(2)
50	30	0.012	AG/A01	4	9	13	10	25	F211AG123(1)050(2)	SMR10123(3)50A01(2)
50	30	0.015	AG/A01	4	9	13	10	25	F211AG153(1)050(2)	SMR10153(3)50A01(2)
50	30	0.018	AG/A01	4	9	13	10	25	F211AG183(1)050(2)	SMR10183(3)50A01(2)
50	30	0.022	AG/A01	4	9	13	10	25	F211AG223(1)050(2)	SMR10223(3)50A01(2)
50	30	0.027	AG/A01	4	9	13	10	25	F211AG273(1)050(2)	SMR10273(3)50A01(2)
50	30	0.033	AG/A01	4	9	13	10	25	F211AG333(1)050(2)	SMR10333(3)50A01(2)
50	30	0.039	AG/A01	4	9	13	10	15	F211AG393(1)050(2)	SMR10393(3)50A01(2)
50	30	0.047	AG/A01	4	9	13	10	15	F211AG473(1)050(2)	SMR10473(3)50A01(2)
50	30	0.056	AG/A01	4	9	13	10	15	F211AG563(1)050(2)	SMR10563(3)50A01(2)
50	30	0.068	AG/A01	4	9	13	10	15	F211AG683(1)050(2)	SMR10683(3)50A01(2)
50	30	0.082	AG/A01	4	9	13	10	10	F211AG823(1)050(2)	SMR10823(3)50A01(2)
50	30	0.1	AG/A01	4	9	13	10	10	F211AG104(1)050(2)	SMR10104(3)50A01(2)
50	30	0.12	AG/A01	4	9	13	10	10	F211AG124(1)050(2)	SMR10124(3)50A01(2)
50	30	0.15	AG/A01	4	9	13	10	10	F211AG154(1)050(2)	SMR10154(3)50A01(2)
50	30	0.18	AG/A01	4	9	13	10	10	F211AG184(1)050(2)	SMR10184(3)50A01(2)
50	30	0.22	AG/A01	4	9	13	10	10	F211AG224(1)050(2)	SMR10224(3)50A01(2)
50	30	0.27	AG/A01	4	9	13	10	8	F211AG274(1)050(2)	SMR10274(3)50A01(2)
50	30	0.33	AG/A01	4	9	13	10	8	F211AG334(1)050(2)	SMR10334(3)50A01(2)
50	30	0.39	AG/A01	4	9	13	10	8	F211AG394(1)050(2)	SMR10394(3)50A01(2)
50	30	0.47	AG/A01	4	9	13	10	8	F211AG474(1)050(2)	SMR10474(3)50A01(2)
50	30	0.56	AG/A01	4	9	13	10	8	F211AG564(1)050(2)	SMR10564(3)50A01(2)
50	30	0.68	AG/A01	4	9	13	10	8	F211AG684(1)050(2)	SMR10684(3)50A01(2)
50	30	0.82	AH/A02	4.5	10.5	13	10	8	F211AH824(1)050(2)	SMR10824(3)50A02(2)
50	30	1	AK/A03	4.5	10.5	13	10	8	F211AK105(1)050(2)	SMR10105(3)50A03(2)
50	30	1.2	AK/A03	5	11	13	10	8	F211AK125(1)050(2)	SMR10125(3)50A03(2)
50	30	1.5	AP/A04	6	12	13	10	8	F211AP155(1)050(2)	SMR10155(3)50A04(2)
50	30	1.8	AP/A04	6	12	13	10	8	F211AP185(1)050(2)	SMR10185(3)50A04(2)
50	30	2.2	BJ/B10	6.5	12.5	18	15	6	F211BJ225(1)050(2)	SMR15225(3)50B10(2)
VDC	VAC	Capacitance Value (µF)	Size Code (New/Legacy)	B (mm)	H (mm)	L (mm)	Lead Spacing (p)	dV/dt (V/µs)	New KEMET Part Number	Legacy Part Number

(1) R = ±2.5%, J = ±5%, K = ±10%, M = ±20%
 (2) Insert lead and packaging code. See Ordering Options Table for available options.
 (3) H = ±2.5%, J = ±5%, K = ±10%, M = ±20%

Table 1 – Ratings & Part Number Reference cont'd

VDC	VAC	Capacitance Value (µF)	Size Code (New/Legacy)	Maximum Dimensions in mm			Lead Spacing (p)	dV/dt (V/µs)	New KEMET Part Number	Legacy Part Number
				B	H	L				
50	30	2.7	BL/B06	7.5	14.5	18	15	6	F211BL275(1)050(2)	SMR15275(3)50B06(2)
50	30	3.3	BL/B06	7.5	14.5	18	15	6	F211BL335(1)050(2)	SMR15335(3)50B06(2)
50	30	3.9	BM/B12	8	15	18	15	6	F211BM395(1)050(2)	SMR15395(3)50B12(2)
50	30	4.7	BV/B14	8.5	16	18	15	6	F211BV475(1)050(2)	SMR15475(3)50B14(2)
50	30	5.6	BV/B14	9.5	17.5	18	15	6	F211BV565(1)050(2)	SMR15565(3)50B14(2)
50	30	6.8	DM/D15	9	18.5	26	22.5	3	F211DM685(1)050(2)	SMR22.5685(3)50D15(2)
50	30	8.2	DM/D15	9	18.5	26	22.5	3	F211DM825(1)050(2)	SMR22.5825(3)50D15(2)
50	30	10	DR/D18	10.5	19	26	22.5	3	F211DR106(1)050(2)	SMR22.5106(3)50D18(2)
50	30	12	DT/D16	11	21.5	26	22.5	3	F211DT126(1)050(2)	SMR22.5126(3)50D16(2)
50	30	15	FE/F11	10.5	20.5	31.5	27.5	2	F211FE156(1)050(2)	SMR27.5156(3)50F11(2)
50	30	18	FG/F12	11.5	22.5	31.5	27.5	2	F211FG186(1)050(2)	SMR27.5186(3)50F12(2)
50	30	22	FM/F13	14.5	24.5	31.5	27.5	2	F211FM226(1)050(2)	SMR27.5226(3)50F13(2)
63	40	0.001	JF/J01	2.5	6.5	7.2	5	40	F211JF102(1)063(2)	SMR5102(3)63J01(2)
63	40	0.0012	JF/J01	2.5	6.5	7.2	5	40	F211JF122(1)063(2)	SMR5122(3)63J01(2)
63	40	0.0015	JF/J01	2.5	6.5	7.2	5	40	F211JF152(1)063(2)	SMR5152(3)63J01(2)
63	40	0.0018	JF/J01	2.5	6.5	7.2	5	40	F211JF182(1)063(2)	SMR5182(3)63J01(2)
63	40	0.0022	JF/J01	2.5	6.5	7.2	5	40	F211JF222(1)063(2)	SMR5222(3)63J01(2)
63	40	0.0027	JF/J01	2.5	6.5	7.2	5	40	F211JF272(1)063(2)	SMR5272(3)63J01(2)
63	40	0.0033	JF/J01	2.5	6.5	7.2	5	40	F211JF332(1)063(2)	SMR5332(3)63J01(2)
63	40	0.0039	JF/J01	2.5	6.5	7.2	5	40	F211JF392(1)063(2)	SMR5392(3)63J01(2)
63	40	0.0047	JF/J01	2.5	6.5	7.2	5	20	F211JF472(1)063(2)	SMR5472(3)63J01(2)
63	40	0.0056	JF/J01	2.5	6.5	7.2	5	20	F211JF562(1)063(2)	SMR5562(3)63J01(2)
63	40	0.0068	JF/J01	2.5	6.5	7.2	5	20	F211JF682(1)063(2)	SMR5682(3)63J01(2)
63	40	0.0082	JF/J01	2.5	6.5	7.2	5	20	F211JF822(1)063(2)	SMR5822(3)63J01(2)
63	40	0.01	JF/J01	2.5	6.5	7.2	5	20	F211JF103(1)063(2)	SMR5103(3)63J01(2)
63	40	0.012	JF/J01	2.5	6.5	7.2	5	15	F211JF123(1)063(2)	SMR5123(3)63J01(2)
63	40	0.015	JF/J01	2.5	6.5	7.2	5	15	F211JF153(1)063(2)	SMR5153(3)63J01(2)
63	40	0.018	JF/J01	2.5	6.5	7.2	5	15	F211JF183(1)063(2)	SMR5183(3)63J01(2)
63	40	0.022	JF/J01	2.5	6.5	7.2	5	15	F211JF223(1)063(2)	SMR5223(3)63J01(2)
63	40	0.027	JF/J01	2.5	6.5	7.2	5	15	F211JF273(1)063(2)	SMR5273(3)63J01(2)
63	40	0.033	JF/J01	2.5	6.5	7.2	5	15	F211JF333(1)063(2)	SMR5333(3)63J01(2)
63	40	0.039	JF/J01	2.5	6.5	7.2	5	15	F211JF393(1)063(2)	SMR5393(3)63J01(2)
63	40	0.047	JF/J01	2.5	6.5	7.2	5	6	F211JF473(1)063(2)	SMR5473(3)63J01(2)
63	40	0.056	JF/J01	2.5	6.5	7.2	5	6	F211JF563(1)063(2)	SMR5563(3)63J01(2)
63	40	0.068	JF/J01	2.5	6.5	7.2	5	6	F211JF683(1)063(2)	SMR5683(3)63J01(2)
63	40	0.082	JJ/J02	3.5	8	7.2	5	6	F211JJ823(1)063(2)	SMR5823(3)63J02(2)
63	40	0.1	JJ/J02	3.5	8	7.2	5	6	F211JJ104(1)063(2)	SMR5104(3)63J02(2)
63	40	0.12	JJ/J02	3.5	8	7.2	5	6	F211JJ124(1)063(2)	SMR5124(3)63J02(2)
63	40	0.15	JJ/J02	3.5	8	7.2	5	6	F211JJ154(1)063(2)	SMR5154(3)63J02(2)
63	40	0.18	JL/J03	4.5	9	7.2	5	6	F211JL184(1)063(2)	SMR5184(3)63J03(2)
63	40	0.22	JL/J03	4.5	9	7.2	5	6	F211JL224(1)063(2)	SMR5224(3)63J03(2)
63	40	0.27	JQ/J04	5	10	7.2	5	6	F211JQ274(1)063(2)	SMR5274(3)63J04(2)
63	40	0.33	JQ/J04	5	10	7.2	5	6	F211JQ334(1)063(2)	SMR5334(3)63J04(2)
63	40	0.39	JT/J05	6	11	7.2	5	6	F211JT394(1)063(2)	SMR5394(3)63J05(2)
63	40	0.47	JT/J05	6	11	7.2	5	6	F211JT474(1)063(2)	SMR5474(3)63J05(2)
63	40	0.56	JU/J06	7.2	13	7.2	5	6	F211JU564(1)063(2)	SMR5564(3)63J06(2)
63	40	0.68	JU/J06	7.2	13	7.2	5	6	F211JU684(1)063(2)	SMR5684(3)63J06(2)
63	40	0.001	KG/K01	4	8	10	7.5	30	F211KG102(1)063(2)	SMR7.5102(3)63K01(2)
63	40	0.0012	KG/K01	4	8	10	7.5	30	F211KG122(1)063(2)	SMR7.5122(3)63K01(2)
63	40	0.0015	KG/K01	4	8	10	7.5	30	F211KG152(1)063(2)	SMR7.5152(3)63K01(2)
63	40	0.0018	KG/K01	4	8	10	7.5	30	F211KG182(1)063(2)	SMR7.5182(3)63K01(2)
63	40	0.0022	KG/K01	4	8	10	7.5	30	F211KG222(1)063(2)	SMR7.5222(3)63K01(2)
63	40	0.0027	KG/K01	4	8	10	7.5	30	F211KG272(1)063(2)	SMR7.5272(3)63K01(2)
63	40	0.0033	KG/K01	4	8	10	7.5	30	F211KG332(1)063(2)	SMR7.5332(3)63K01(2)
63	40	0.0039	KG/K01	4	8	10	7.5	30	F211KG392(1)063(2)	SMR7.5392(3)63K01(2)
63	40	0.0047	KG/K01	4	8	10	7.5	30	F211KG472(1)063(2)	SMR7.5472(3)63K01(2)
VDC	VAC	Capacitance Value (µF)	Size Code (New/Legacy)	B (mm)	H (mm)	L (mm)	Lead Spacing (p)	dV/dt (V/µs)	New KEMET Part Number	Legacy Part Number

(1) R = ±2.5%, J = ±5%, K = ±10%, M = ±20%
 (2) Insert lead and packaging code. See Ordering Options Table for available options.
 (3) H = ±2.5%, J = ±5%, K = ±10%, M = ±20%

Table 1 – Ratings & Part Number Reference cont'd

VDC	VAC	Capacitance Value (µF)	Size Code (New/Legacy)	Maximum Dimensions in mm			Lead Spacing (p)	dV/dt (V/µs)	New KEMET Part Number	Legacy Part Number
				B	H	L				
63	40	0.0056	KG/K01	4	8	10	7.5	30	F211KG562(1)063(2)	SMR7.5562(3)63K01(2)
63	40	0.0068	KG/K01	4	8	10	7.5	30	F211KG682(1)063(2)	SMR7.5682(3)63K01(2)
63	40	0.0082	KG/K01	4	8	10	7.5	30	F211KG822(1)063(2)	SMR7.5822(3)63K01(2)
63	40	0.01	KG/K01	4	8	10	7.5	30	F211KG103(1)063(2)	SMR7.5103(3)63K01(2)
63	40	0.012	KG/K01	4	8	10	7.5	30	F211KG123(1)063(2)	SMR7.5123(3)63K01(2)
63	40	0.015	KG/K01	4	8	10	7.5	30	F211KG153(1)063(2)	SMR7.5153(3)63K01(2)
63	40	0.018	KG/K01	4	8	10	7.5	30	F211KG183(1)063(2)	SMR7.5183(3)63K01(2)
63	40	0.022	KG/K01	4	8	10	7.5	30	F211KG223(1)063(2)	SMR7.5223(3)63K01(2)
63	40	0.027	KG/K01	4	8	10	7.5	20	F211KG273(1)063(2)	SMR7.5273(3)63K01(2)
63	40	0.033	KG/K01	4	8	10	7.5	20	F211KG333(1)063(2)	SMR7.5333(3)63K01(2)
63	40	0.039	KG/K01	4	8	10	7.5	20	F211KG393(1)063(2)	SMR7.5393(3)63K01(2)
63	40	0.047	KG/K01	4	8	10	7.5	20	F211KG473(1)063(2)	SMR7.5473(3)63K01(2)
63	40	0.056	KG/K01	4	8	10	7.5	15	F211KG563(1)063(2)	SMR7.5563(3)63K01(2)
63	40	0.068	KG/K01	4	8	10	7.5	15	F211KG683(1)063(2)	SMR7.5683(3)63K01(2)
63	40	0.082	KG/K01	4	8	10	7.5	15	F211KG823(1)063(2)	SMR7.5823(3)63K01(2)
63	40	0.1	KG/K01	4	8	10	7.5	15	F211KG104(1)063(2)	SMR7.5104(3)63K01(2)
63	40	0.12	KG/K01	4	8	10	7.5	15	F211KG124(1)063(2)	SMR7.5124(3)63K01(2)
63	40	0.15	KG/K01	4	8	10	7.5	10	F211KG154(1)063(2)	SMR7.5154(3)63K01(2)
63	40	0.18	KG/K01	4	8	10	7.5	10	F211KG184(1)063(2)	SMR7.5184(3)63K01(2)
63	40	0.22	KG/K01	4	8	10	7.5	10	F211KG224(1)063(2)	SMR7.5224(3)63K01(2)
63	40	0.27	KG/K01	4	8	10	7.5	10	F211KG274(1)063(2)	SMR7.5274(3)63K01(2)
63	40	0.33	KK/K03	5	11	10	7.5	10	F211KK334(1)063(2)	SMR7.5334(3)63K03(2)
63	40	0.39	KK/K03	5	11	10	7.5	10	F211KK394(1)063(2)	SMR7.5394(3)63K03(2)
63	40	0.47	KK/K03	5	11	10	7.5	10	F211KK474(1)063(2)	SMR7.5474(3)63K03(2)
63	40	0.56	KK/K03	5	11	10	7.5	10	F211KK564(1)063(2)	SMR7.5564(3)63K03(2)
63	40	0.68	KM/K04	6	12	10.5	7.5	10	F211KM684(1)063(2)	SMR7.5684(3)63K04(2)
63	40	0.82	KM/K04	6	12	10.5	7.5	10	F211KM824(1)063(2)	SMR7.5824(3)63K04(2)
63	40	0.0027	AG/A01	4	9	13	10	25	F211AG272(1)063(2)	SMR10272(3)63A01(2)
63	40	0.0033	AG/A01	4	9	13	10	25	F211AG332(1)063(2)	SMR10332(3)63A01(2)
63	40	0.0039	AG/A01	4	9	13	10	25	F211AG392(1)063(2)	SMR10392(3)63A01(2)
63	40	0.0047	AG/A01	4	9	13	10	25	F211AG472(1)063(2)	SMR10472(3)63A01(2)
63	40	0.0056	AG/A01	4	9	13	10	25	F211AG562(1)063(2)	SMR10562(3)63A01(2)
63	40	0.0068	AG/A01	4	9	13	10	25	F211AG682(1)063(2)	SMR10682(3)63A01(2)
63	40	0.0082	AG/A01	4	9	13	10	25	F211AG822(1)063(2)	SMR10822(3)63A01(2)
63	40	0.01	AG/A01	4	9	13	10	25	F211AG103(1)063(2)	SMR10103(3)63A01(2)
63	40	0.012	AG/A01	4	9	13	10	25	F211AG123(1)063(2)	SMR10123(3)63A01(2)
63	40	0.015	AG/A01	4	9	13	10	25	F211AG153(1)063(2)	SMR10153(3)63A01(2)
63	40	0.018	AG/A01	4	9	13	10	25	F211AG183(1)063(2)	SMR10183(3)63A01(2)
63	40	0.022	AG/A01	4	9	13	10	25	F211AG223(1)063(2)	SMR10223(3)63A01(2)
63	40	0.027	AG/A01	4	9	13	10	25	F211AG273(1)063(2)	SMR10273(3)63A01(2)
63	40	0.033	AG/A01	4	9	13	10	25	F211AG333(1)063(2)	SMR10333(3)63A01(2)
63	40	0.039	AG/A01	4	9	13	10	15	F211AG393(1)063(2)	SMR10393(3)63A01(2)
63	40	0.047	AG/A01	4	9	13	10	15	F211AG473(1)063(2)	SMR10473(3)63A01(2)
63	40	0.056	AG/A01	4	9	13	10	15	F211AG563(1)063(2)	SMR10563(3)63A01(2)
63	40	0.068	AG/A01	4	9	13	10	15	F211AG683(1)063(2)	SMR10683(3)63A01(2)
63	40	0.082	AG/A01	4	9	13	10	10	F211AG823(1)063(2)	SMR10823(3)63A01(2)
63	40	0.1	AG/A01	4	9	13	10	10	F211AG104(1)063(2)	SMR10104(3)63A01(2)
63	40	0.12	AG/A01	4	9	13	10	10	F211AG124(1)063(2)	SMR10124(3)63A01(2)
63	40	0.15	AG/A01	4	9	13	10	10	F211AG154(1)063(2)	SMR10154(3)63A01(2)
63	40	0.18	AG/A01	4	9	13	10	10	F211AG184(1)063(2)	SMR10184(3)63A01(2)
63	40	0.22	AG/A01	4	9	13	10	10	F211AG224(1)063(2)	SMR10224(3)63A01(2)
63	40	0.27	AG/A01	4	9	13	10	8	F211AG274(1)063(2)	SMR10274(3)63A01(2)
63	40	0.33	AG/A01	4	9	13	10	8	F211AG334(1)063(2)	SMR10334(3)63A01(2)
63	40	0.39	AG/A01	4	9	13	10	8	F211AG394(1)063(2)	SMR10394(3)63A01(2)
63	40	0.47	AH/A02	4.5	10.5	13	10	8	F211AH474(1)063(2)	SMR10474(3)63A02(2)
63	40	0.56	AH/A02	4.5	10.5	13	10	8	F211AH564(1)063(2)	SMR10564(3)63A02(2)
VDC	VAC	Capacitance Value (µF)	Size Code (New/Legacy)	B (mm)	H (mm)	L (mm)	Lead Spacing (p)	dV/dt (V/µs)	New KEMET Part Number	Legacy Part Number

(1) R = ±2.5%, J = ±5%, K = ±10%, M = ±20%
 (2) Insert lead and packaging code. See Ordering Options Table for available options.
 (3) H = ±2.5%, J = ±5%, K = ±10%, M = ±20%

Table 1 – Ratings & Part Number Reference cont'd

VDC	VAC	Capacitance Value (µF)	Size Code (New/Legacy)	Maximum Dimensions in mm			Lead Spacing (p)	dV/dt (V/µs)	New KEMET Part Number	Legacy Part Number
				B	H	L				
63	40	0.68	AK/A03	5	11	13	10	8	F211AK684(1)063(2)	SMR10684(3)63A03(2)
63	40	0.82	AP/A04	6	12	13	10	8	F211AP824(1)063(2)	SMR10824(3)63A04(2)
63	40	1	AP/A04	6	12	13	10	8	F211AP105(1)063(2)	SMR10105(3)63A04(2)
63	40	0.68	BD/B04	5.5	10.5	18	15	8	F211BD684(1)063(2)	SMR15684(3)63B04(2)
63	40	0.82	BD/B04	5.5	10.5	18	15	8	F211BD824(1)063(2)	SMR15824(3)63B04(2)
63	40	1	BE/B05	5.5	12.5	18	15	8	F211BE105(1)063(2)	SMR15105(3)63B05(2)
63	40	1.2	BJ/B10	6.5	12.5	18	15	6	F211BJ125(1)063(2)	SMR15125(3)63B10(2)
63	40	1.5	BJ/B10	6.5	12.5	18	15	6	F211BJ155(1)063(2)	SMR15155(3)63B10(2)
63	40	1.8	BL/B06	7.5	14.5	18	15	6	F211BL185(1)063(2)	SMR15185(3)63B06(2)
63	40	2.2	BM/B12	8	15	18	15	6	F211BM225(1)063(2)	SMR15225(3)63B12(2)
63	40	2.7	BQ/B11	8.5	16	18	15	6	F211BQ275(1)063(2)	SMR15275(3)63B11(2)
63	40	3.3	BV/B14	9.5	17.5	18	15	6	F211BV335(1)063(2)	SMR15335(3)63B14(2)
63	40	2.7	DD/D13	6.5	14.5	26	22.5	3	F211DD275(1)063(2)	SMR22.5275(3)63D13(2)
63	40	3.3	DF/D17	7	16.5	26	22.5	3	F211DF335(1)063(2)	SMR22.5335(3)63D17(2)
63	40	3.9	DH/D14	8	16	26	22.5	3	F211DH395(1)063(2)	SMR22.5395(3)63D14(2)
63	40	4.7	DM/D15	9	18.5	26	22.5	3	F211DM475(1)063(2)	SMR22.5475(3)63D15(2)
63	40	5.6	DM/D15	9	18.5	26	22.5	3	F211DM565(1)063(2)	SMR22.5565(3)63D15(2)
63	40	6.8	DR/D18	10.5	19	26	22.5	3	F211DR685(1)063(2)	SMR22.5685(3)63D18(2)
63	40	8.2	DT/D16	11	21.5	26	22.5	3	F211DT825(1)063(2)	SMR22.5825(3)63D16(2)
63	40	10	FG/F12	11.5	22.5	31.5	27.5	2	F211FG106(1)063(2)	SMR27.5106(3)63F12(2)
63	40	12	FM/F13	14.5	24.5	31.5	27.5	2	F211FM126(1)063(2)	SMR27.5126(3)63F13(2)
63	40	15	FM/F13	14.5	24.5	31.5	27.5	2	F211FM156(1)063(2)	SMR27.5156(3)63F13(2)
63	40	18	FR/F14	17.5	28	31.5	27.5	2	F211FR186(1)063(2)	SMR27.5186(3)63F14(2)
63	40	22	FR/F14	17.5	28	31.5	27.5	2	F211FR226(1)063(2)	SMR27.5226(3)63F14(2)
100	63	0.001	JF/J01	2.5	6.5	7.2	5	40	F211JF102(1)100(2)	SMR5102(3)100J01(2)
100	63	0.0012	JF/J01	2.5	6.5	7.2	5	40	F211JF122(1)100(2)	SMR5122(3)100J01(2)
100	63	0.0015	JF/J01	2.5	6.5	7.2	5	40	F211JF152(1)100(2)	SMR5152(3)100J01(2)
100	63	0.0018	JF/J01	2.5	6.5	7.2	5	40	F211JF182(1)100(2)	SMR5182(3)100J01(2)
100	63	0.0022	JF/J01	2.5	6.5	7.2	5	40	F211JF222(1)100(2)	SMR5222(3)100J01(2)
100	63	0.0027	JF/J01	2.5	6.5	7.2	5	40	F211JF272(1)100(2)	SMR5272(3)100J01(2)
100	63	0.0033	JF/J01	2.5	6.5	7.2	5	40	F211JF332(1)100(2)	SMR5332(3)100J01(2)
100	63	0.0039	JF/J01	2.5	6.5	7.2	5	40	F211JF392(1)100(2)	SMR5392(3)100J01(2)
100	63	0.0047	JF/J01	2.5	6.5	7.2	5	20	F211JF472(1)100(2)	SMR5472(3)100J01(2)
100	63	0.0056	JF/J01	2.5	6.5	7.2	5	20	F211JF562(1)100(2)	SMR5562(3)100J01(2)
100	63	0.0068	JF/J01	2.5	6.5	7.2	5	20	F211JF682(1)100(2)	SMR5682(3)100J01(2)
100	63	0.0082	JF/J01	2.5	6.5	7.2	5	20	F211JF822(1)100(2)	SMR5822(3)100J01(2)
100	63	0.01	JF/J01	2.5	6.5	7.2	5	20	F211JF103(1)100(2)	SMR5103(3)100J01(2)
100	63	0.012	JF/J01	2.5	6.5	7.2	5	15	F211JF123(1)100(2)	SMR5123(3)100J01(2)
100	63	0.015	JF/J01	2.5	6.5	7.2	5	15	F211JF153(1)100(2)	SMR5153(3)100J01(2)
100	63	0.018	JF/J01	2.5	6.5	7.2	5	15	F211JF183(1)100(2)	SMR5183(3)100J01(2)
100	63	0.022	JF/J01	2.5	6.5	7.2	5	15	F211JF223(1)100(2)	SMR5223(3)100J01(2)
100	63	0.027	JF/J01	2.5	6.5	7.2	5	15	F211JF273(1)100(2)	SMR5273(3)100J01(2)
100	63	0.033	JF/J01	2.5	6.5	7.2	5	15	F211JF333(1)100(2)	SMR5333(3)100J01(2)
100	63	0.039	JF/J01	2.5	6.5	7.2	5	15	F211JF393(1)100(2)	SMR5393(3)100J01(2)
100	63	0.047	JJ/J02	3.5	8	7.2	5	15	F211JJ473(1)100(2)	SMR5473(3)100J02(2)
100	63	0.056	JL/J03	4.5	9	7.2	5	15	F211JL563(1)100(2)	SMR5563(3)100J03(2)
100	63	0.068	JL/J03	4.5	9	7.2	5	15	F211JL683(1)100(2)	SMR5683(3)100J03(2)
100	63	0.082	JL/J03	4.5	9	7.2	5	15	F211JL823(1)100(2)	SMR5823(3)100J03(2)
100	63	0.1	JL/J03	4.5	9	7.2	5	15	F211JL104(1)100(2)	SMR5104(3)100J03(2)
100	63	0.12	JQ/J04	5	10	7.2	5	15	F211JQ124(1)100(2)	SMR5124(3)100J04(2)
100	63	0.15	JT/J05	6	11	7.2	5	15	F211JT154(1)100(2)	SMR5154(3)100J05(2)
100	63	0.18	JT/J05	6	11	7.2	5	15	F211JT184(1)100(2)	SMR5184(3)100J05(2)
100	63	0.22	JU/J06	7.2	13	7.2	5	15	F211JU224(1)100(2)	SMR5224(3)100J06(2)
100	63	0.27	JU/J06	7.2	13	7.2	5	15	F211JU274(1)100(2)	SMR5274(3)100J06(2)
100	63	0.33	JU/J06	7.2	13	7.2	5	15	F211JU334(1)100(2)	SMR5334(3)100J06(2)
100	63	0.001	KG/K01	4	8	10	7.5	30	F211KG102(1)100(2)	SMR7.5102(3)100K01(2)
VDC	VAC	Capacitance Value (µF)	Size Code (New/Legacy)	B (mm)	H (mm)	L (mm)	Lead Spacing (p)	dV/dt (V/µs)	New KEMET Part Number	Legacy Part Number

(1) R = ±2.5%, J = ±5%, K = ±10%, M = ±20%
 (2) Insert lead and packaging code. See Ordering Options Table for available options.
 (3) H = ±2.5%, J = ±5%, K = ±10%, M = ±20%

Table 1 – Ratings & Part Number Reference cont'd

VDC	VAC	Capacitance Value (µF)	Size Code (New/Legacy)	Maximum Dimensions in mm			Lead Spacing (p)	dV/dt (V/µs)	New KEMET Part Number	Legacy Part Number
				B	H	L				
100	63	0.0012	KG/K01	4	8	10	7.5	30	F211KG122(1)100(2)	SMR7.5122(3)100K01(2)
100	63	0.0015	KG/K01	4	8	10	7.5	30	F211KG152(1)100(2)	SMR7.5152(3)100K01(2)
100	63	0.0018	KG/K01	4	8	10	7.5	30	F211KG182(1)100(2)	SMR7.5182(3)100K01(2)
100	63	0.0022	KG/K01	4	8	10	7.5	30	F211KG222(1)100(2)	SMR7.5222(3)100K01(2)
100	63	0.0027	KG/K01	4	8	10	7.5	30	F211KG272(1)100(2)	SMR7.5272(3)100K01(2)
100	63	0.0033	KG/K01	4	8	10	7.5	30	F211KG332(1)100(2)	SMR7.5332(3)100K01(2)
100	63	0.0039	KG/K01	4	8	10	7.5	30	F211KG392(1)100(2)	SMR7.5392(3)100K01(2)
100	63	0.0047	KG/K01	4	8	10	7.5	30	F211KG472(1)100(2)	SMR7.5472(3)100K01(2)
100	63	0.0056	KG/K01	4	8	10	7.5	30	F211KG562(1)100(2)	SMR7.5562(3)100K01(2)
100	63	0.0068	KG/K01	4	8	10	7.5	30	F211KG682(1)100(2)	SMR7.5682(3)100K01(2)
100	63	0.0082	KG/K01	4	8	10	7.5	30	F211KG822(1)100(2)	SMR7.5822(3)100K01(2)
100	63	0.01	KG/K01	4	8	10	7.5	30	F211KG103(1)100(2)	SMR7.5103(3)100K01(2)
100	63	0.012	KG/K01	4	8	10	7.5	30	F211KG123(1)100(2)	SMR7.5123(3)100K01(2)
100	63	0.015	KG/K01	4	8	10	7.5	30	F211KG153(1)100(2)	SMR7.5153(3)100K01(2)
100	63	0.018	KG/K01	4	8	10	7.5	30	F211KG183(1)100(2)	SMR7.5183(3)100K01(2)
100	63	0.022	KG/K01	4	8	10	7.5	30	F211KG223(1)100(2)	SMR7.5223(3)100K01(2)
100	63	0.027	KG/K01	4	8	10	7.5	20	F211KG273(1)100(2)	SMR7.5273(3)100K01(2)
100	63	0.033	KG/K01	4	8	10	7.5	20	F211KG333(1)100(2)	SMR7.5333(3)100K01(2)
100	63	0.039	KG/K01	4	8	10	7.5	20	F211KG393(1)100(2)	SMR7.5393(3)100K01(2)
100	63	0.047	KG/K01	4	8	10	7.5	20	F211KG473(1)100(2)	SMR7.5473(3)100K01(2)
100	63	0.056	KG/K01	4	8	10	7.5	15	F211KG563(1)100(2)	SMR7.5563(3)100K01(2)
100	63	0.068	KG/K01	4	8	10	7.5	15	F211KG683(1)100(2)	SMR7.5683(3)100K01(2)
100	63	0.082	KG/K01	4	8	10	7.5	15	F211KG823(1)100(2)	SMR7.5823(3)100K01(2)
100	63	0.1	KG/K01	4	8	10	7.5	15	F211KG104(1)100(2)	SMR7.5104(3)100K01(2)
100	63	0.12	KG/K01	4	8	10	7.5	15	F211KG124(1)100(2)	SMR7.5124(3)100K01(2)
100	63	0.15	KK/K03	5	11	10	7.5	15	F211KK154(1)100(2)	SMR7.5154(3)100K03(2)
100	63	0.18	KK/K03	5	11	10	7.5	15	F211KK184(1)100(2)	SMR7.5184(3)100K03(2)
100	63	0.22	KK/K03	5	11	10	7.5	15	F211KK224(1)100(2)	SMR7.5224(3)100K03(2)
100	63	0.27	KK/K03	5	11	10	7.5	15	F211KK274(1)100(2)	SMR7.5274(3)100K03(2)
100	63	0.33	KM/K04	6	12	10.5	7.5	15	F211KM334(1)100(2)	SMR7.5334(3)100K04(2)
100	63	0.39	KM/K04	6	12	10.5	7.5	15	F211KM394(1)100(2)	SMR7.5394(3)100K04(2)
100	63	0.47	KM/K04	6	12	10.5	7.5	15	F211KM474(1)100(2)	SMR7.5474(3)100K04(2)
100	63	0.0027	AG/A01	4	9	13	10	25	F211AG272(1)100(2)	SMR10272(3)100A01(2)
100	63	0.0033	AG/A01	4	9	13	10	25	F211AG332(1)100(2)	SMR10332(3)100A01(2)
100	63	0.0039	AG/A01	4	9	13	10	25	F211AG392(1)100(2)	SMR10392(3)100A01(2)
100	63	0.0047	AG/A01	4	9	13	10	25	F211AG472(1)100(2)	SMR10472(3)100A01(2)
100	63	0.0056	AG/A01	4	9	13	10	25	F211AG562(1)100(2)	SMR10562(3)100A01(2)
100	63	0.0068	AG/A01	4	9	13	10	25	F211AG682(1)100(2)	SMR10682(3)100A01(2)
100	63	0.0082	AG/A01	4	9	13	10	25	F211AG822(1)100(2)	SMR10822(3)100A01(2)
100	63	0.01	AG/A01	4	9	13	10	25	F211AG103(1)100(2)	SMR10103(3)100A01(2)
100	63	0.012	AG/A01	4	9	13	10	25	F211AG123(1)100(2)	SMR10123(3)100A01(2)
100	63	0.015	AG/A01	4	9	13	10	25	F211AG153(1)100(2)	SMR10153(3)100A01(2)
100	63	0.018	AG/A01	4	9	13	10	25	F211AG183(1)100(2)	SMR10183(3)100A01(2)
100	63	0.022	AG/A01	4	9	13	10	25	F211AG223(1)100(2)	SMR10223(3)100A01(2)
100	63	0.027	AG/A01	4	9	13	10	25	F211AG273(1)100(2)	SMR10273(3)100A01(2)
100	63	0.033	AG/A01	4	9	13	10	25	F211AG333(1)100(2)	SMR10333(3)100A01(2)
100	63	0.039	AG/A01	4	9	13	10	15	F211AG393(1)100(2)	SMR10393(3)100A01(2)
100	63	0.047	AG/A01	4	9	13	10	15	F211AG473(1)100(2)	SMR10473(3)100A01(2)
100	63	0.056	AG/A01	4	9	13	10	15	F211AG563(1)100(2)	SMR10563(3)100A01(2)
100	63	0.068	AG/A01	4	9	13	10	15	F211AG683(1)100(2)	SMR10683(3)100A01(2)
100	63	0.082	AG/A01	4	9	13	10	10	F211AG823(1)100(2)	SMR10823(3)100A01(2)
100	63	0.1	AG/A01	4	9	13	10	10	F211AG104(1)100(2)	SMR10104(3)100A01(2)
100	63	0.12	AG/A01	4	9	13	10	10	F211AG124(1)100(2)	SMR10124(3)100A01(2)
100	63	0.15	AG/A01	4	9	13	10	10	F211AG154(1)100(2)	SMR10154(3)100A01(2)
100	63	0.18	AG/A01	4	9	13	10	10	F211AG184(1)100(2)	SMR10184(3)100A01(2)
100	63	0.22	AG/A01	4	9	13	10	10	F211AG224(1)100(2)	SMR10224(3)100A01(2)
VDC	VAC	Capacitance Value (µF)	Size Code (New/Legacy)	B (mm)	H (mm)	L (mm)	Lead Spacing (p)	dV/dt (V/µs)	New KEMET Part Number	Legacy Part Number

(1) R = ±2.5%, J = ±5%, K = ±10%, M = ±20%
 (2) Insert lead and packaging code. See Ordering Options Table for available options.
 (3) H = ±2.5%, J = ±5%, K = ±10%, M = ±20%

Table 1 – Ratings & Part Number Reference cont'd

VDC	VAC	Capacitance Value (µF)	Size Code (New/Legacy)	Maximum Dimensions in mm			Lead Spacing (p)	dV/dt (V/µs)	New KEMET Part Number	Legacy Part Number
				B	H	L				
100	63	0.27	AH/A02	4.5	10.5	13	10	10	F211AH274(1)100(2)	SMR10274(3)100A02(2)
100	63	0.33	AK/A03	5	11	13	10	10	F211AK334(1)100(2)	SMR10334(3)100A03(2)
100	63	0.39	AK/A03	5	11	13	10	10	F211AK394(1)100(2)	SMR10394(3)100A03(2)
100	63	0.47	AP/A04	6	12	13	10	10	F211AP474(1)100(2)	SMR10474(3)100A04(2)
100	63	0.56	AP/A04	6	12	13	10	10	F211AP564(1)100(2)	SMR10564(3)100A04(2)
100	63	0.27	BD/B04	5.5	10.5	18	15	8	F211BD274(1)100(2)	SMR15274(3)100B04(2)
100	63	0.33	BD/B04	5.5	10.5	18	15	8	F211BD334(1)100(2)	SMR15334(3)100B04(2)
100	63	0.39	BD/B04	5.5	10.5	18	15	8	F211BD394(1)100(2)	SMR15394(3)100B04(2)
100	63	0.47	BD/B04	5.5	10.5	18	15	8	F211BD474(1)100(2)	SMR15474(3)100B04(2)
100	63	0.56	BE/B05	5.5	12.5	18	15	8	F211BE564(1)100(2)	SMR15564(3)100B05(2)
100	63	0.68	BJ/B10	6.5	12.5	18	15	8	F211BJ684(1)100(2)	SMR15684(3)100B10(2)
100	63	0.82	BL/B06	7.5	14.5	18	15	8	F211BL824(1)100(2)	SMR15824(3)100B06(2)
100	63	1	BL/B06	7.5	14.5	18	15	8	F211BL105(1)100(2)	SMR15105(3)100B06(2)
100	63	1.2	BM/B12	8	15	18	15	8	F211BM125(1)100(2)	SMR15125(3)100B12(2)
100	63	1.5	BQ/B11	8.5	16	18	15	8	F211BQ155(1)100(2)	SMR15155(3)100B11(2)
100	63	1.8	BV/B14	9.5	17.5	18	15	8	F211BV185(1)100(2)	SMR15185(3)100B14(2)
100	63	1.5	DD/D13	6.5	14.5	26	22.5	4	F211DD155(1)100(2)	SMR22.5155(3)100D13(2)
100	63	1.8	DF/D17	7	16.5	26	22.5	4	F211DF185(1)100(2)	SMR22.5185(3)100D17(2)
100	63	2.2	DH/D14	8	16	26	22.5	4	F211DH225(1)100(2)	SMR22.5225(3)100D14(2)
100	63	2.7	DM/D15	9	18.5	26	22.5	4	F211DM275(1)100(2)	SMR22.5275(3)100D15(2)
100	63	3.3	DR/D18	10.5	19	26	22.5	4	F211DR335(1)100(2)	SMR22.5335(3)100D18(2)
100	63	3.9	DR/D18	10.5	19	26	22.5	4	F211DR395(1)100(2)	SMR22.5395(3)100D18(2)
100	63	4.7	DT/D16	11	21.5	26	22.5	4	F211DT475(1)100(2)	SMR22.5475(3)100D16(2)
100	63	5.6	FG/F12	11.5	22.5	31.5	27.5	3	F211FG565(1)100(2)	SMR27.5565(3)100F12(2)
100	63	6.8	FM/F13	14.5	24.5	31.5	27.5	3	F211FM685(1)100(2)	SMR27.5685(3)100F13(2)
100	63	8.2	FM/F13	14.5	24.5	31.5	27.5	3	F211FM825(1)100(2)	SMR27.5825(3)100F13(2)
100	63	10	FR/F14	17.5	28	31.5	27.5	3	F211FR106(1)100(2)	SMR27.5106(3)100F14(2)
100	63	12	FR/F14	17.5	28	31.5	27.5	3	F211FR126(1)100(2)	SMR27.5126(3)100F14(2)
250	160	0.001	JF/J01	2.5	6.5	7.2	5	40	F211JF102(1)250(2)	SMR5102(3)250J01(2)
250	160	0.0012	JF/J01	2.5	6.5	7.2	5	40	F211JF122(1)250(2)	SMR5122(3)250J01(2)
250	160	0.0015	JF/J01	2.5	6.5	7.2	5	40	F211JF152(1)250(2)	SMR5152(3)250J01(2)
250	160	0.0018	JF/J01	2.5	6.5	7.2	5	40	F211JF182(1)250(2)	SMR5182(3)250J01(2)
250	160	0.0022	JF/J01	2.5	6.5	7.2	5	40	F211JF222(1)250(2)	SMR5222(3)250J01(2)
250	160	0.0027	JF/J01	2.5	6.5	7.2	5	40	F211JF272(1)250(2)	SMR5272(3)250J01(2)
250	160	0.0033	JF/J01	2.5	6.5	7.2	5	40	F211JF332(1)250(2)	SMR5332(3)250J01(2)
250	160	0.0039	JF/J01	2.5	6.5	7.2	5	40	F211JF392(1)250(2)	SMR5392(3)250J01(2)
250	160	0.0047	JF/J01	2.5	6.5	7.2	5	20	F211JF472(1)250(2)	SMR5472(3)250J01(2)
250	160	0.0056	JF/J01	2.5	6.5	7.2	5	20	F211JF562(1)250(2)	SMR5562(3)250J01(2)
250	160	0.0068	JF/J01	2.5	6.5	7.2	5	20	F211JF682(1)250(2)	SMR5682(3)250J01(2)
250	160	0.0082	JF/J01	2.5	6.5	7.2	5	20	F211JF822(1)250(2)	SMR5822(3)250J01(2)
250	160	0.01	JF/J01	2.5	6.5	7.2	5	20	F211JF103(1)250(2)	SMR5103(3)250J01(2)
250	160	0.012	JF/J01	2.5	6.5	7.2	5	20	F211JF123(1)250(2)	SMR5123(3)250J01(2)
250	160	0.015	JJ/J02	3.5	8	7.2	5	20	F211JJ153(1)250(2)	SMR5153(3)250J02(2)
250	160	0.018	JJ/J02	3.5	8	7.2	5	20	F211JJ183(1)250(2)	SMR5183(3)250J02(2)
250	160	0.022	JJ/J02	3.5	8	7.2	5	20	F211JJ223(1)250(2)	SMR5223(3)250J02(2)
250	160	0.027	JJ/J02	3.5	8	7.2	5	20	F211JJ273(1)250(2)	SMR5273(3)250J02(2)
250	160	0.033	JL/J03	4.5	9	7.2	5	20	F211JL333(1)250(2)	SMR5333(3)250J03(2)
250	160	0.039	JL/J03	4.5	9	7.2	5	20	F211JL393(1)250(2)	SMR5393(3)250J03(2)
250	160	0.047	JL/J03	4.5	9	7.2	5	20	F211JL473(1)250(2)	SMR5473(3)250J03(2)
250	160	0.056	JQ/J04	5	10	7.2	5	20	F211JQ563(1)250(2)	SMR5563(3)250J04(2)
250	160	0.068	JT/J05	6	11	7.2	5	20	F211JT683(1)250(2)	SMR5683(3)250J05(2)
250	160	0.082	JT/J05	6	11	7.2	5	20	F211JT823(1)250(2)	SMR5823(3)250J05(2)
250	160	0.1	JU/J06	7.2	13	7.2	5	20	F211JU104(1)250(2)	SMR5104(3)250J06(2)
250	160	0.12	JU/J06	7.2	13	7.2	5	20	F211JU124(1)250(2)	SMR5124(3)250J06(2)
250	160	0.001	KG/K01	4	8	10	7.5	30	F211KG102(1)250(2)	SMR7.5102(3)250K01(2)
250	160	0.0012	KG/K01	4	8	10	7.5	30	F211KG122(1)250(2)	SMR7.5122(3)250K01(2)
VDC	VAC	Capacitance Value (µF)	Size Code (New/Legacy)	B (mm)	H (mm)	L (mm)	Lead Spacing (p)	dV/dt (V/µs)	New KEMET Part Number	Legacy Part Number

(1) R = ±2.5%, J = ±5%, K = ±10%, M = ±20%

(2) Insert lead and packaging code. See Ordering Options Table for available options.

(3) H = ±2.5%, J = ±5%, K = ±10%, M = ±20%

Table 1 – Ratings & Part Number Reference cont'd

VDC	VAC	Capacitance Value (µF)	Size Code (New/Legacy)	Maximum Dimensions in mm			Lead Spacing (p)	dV/dt (V/µs)	New KEMET Part Number	Legacy Part Number
				B	H	L				
250	160	0.0015	KG/K01	4	8	10	7.5	30	F211KG152(1)250(2)	SMR7.5152(3)250K01(2)
250	160	0.0018	KG/K01	4	8	10	7.5	30	F211KG182(1)250(2)	SMR7.5182(3)250K01(2)
250	160	0.0022	KG/K01	4	8	10	7.5	30	F211KG222(1)250(2)	SMR7.5222(3)250K01(2)
250	160	0.0027	KG/K01	4	8	10	7.5	30	F211KG272(1)250(2)	SMR7.5272(3)250K01(2)
250	160	0.0033	KG/K01	4	8	10	7.5	30	F211KG332(1)250(2)	SMR7.5332(3)250K01(2)
250	160	0.0039	KG/K01	4	8	10	7.5	30	F211KG392(1)250(2)	SMR7.5392(3)250K01(2)
250	160	0.0047	KG/K01	4	8	10	7.5	30	F211KG472(1)250(2)	SMR7.5472(3)250K01(2)
250	160	0.0056	KG/K01	4	8	10	7.5	30	F211KG562(1)250(2)	SMR7.5562(3)250K01(2)
250	160	0.0068	KG/K01	4	8	10	7.5	30	F211KG682(1)250(2)	SMR7.5682(3)250K01(2)
250	160	0.0082	KG/K01	4	8	10	7.5	30	F211KG822(1)250(2)	SMR7.5822(3)250K01(2)
250	160	0.01	KG/K01	4	8	10	7.5	30	F211KG103(1)250(2)	SMR7.5103(3)250K01(2)
250	160	0.012	KG/K01	4	8	10	7.5	30	F211KG123(1)250(2)	SMR7.5123(3)250K01(2)
250	160	0.015	KG/K01	4	8	10	7.5	30	F211KG153(1)250(2)	SMR7.5153(3)250K01(2)
250	160	0.018	KG/K01	4	8	10	7.5	30	F211KG183(1)250(2)	SMR7.5183(3)250K01(2)
250	160	0.022	KG/K01	4	8	10	7.5	30	F211KG223(1)250(2)	SMR7.5223(3)250K01(2)
250	160	0.027	KG/K01	4	8	10	7.5	20	F211KG273(1)250(2)	SMR7.5273(3)250K01(2)
250	160	0.033	KG/K01	4	8	10	7.5	20	F211KG333(1)250(2)	SMR7.5333(3)250K01(2)
250	160	0.039	KG/K01	4	8	10	7.5	20	F211KG393(1)250(2)	SMR7.5393(3)250K01(2)
250	160	0.047	KG/K01	4	8	10	7.5	20	F211KG473(1)250(2)	SMR7.5473(3)250K01(2)
250	160	0.056	KK/K03	5	11	10	7.5	20	F211KK563(1)250(2)	SMR7.5563(3)250K03(2)
250	160	0.068	KK/K03	5	11	10	7.5	20	F211KK683(1)250(2)	SMR7.5683(3)250K03(2)
250	160	0.082	KK/K03	5	11	10	7.5	20	F211KK823(1)250(2)	SMR7.5823(3)250K03(2)
250	160	0.1	KK/K03	5	11	10	7.5	20	F211KK104(1)250(2)	SMR7.5104(3)250K03(2)
250	160	0.12	KM/K04	6	12	10.5	7.5	20	F211KM124(1)250(2)	SMR7.5124(3)250K04(2)
250	160	0.15	KM/K04	6	12	10.5	7.5	20	F211KM154(1)250(2)	SMR7.5154(3)250K04(2)
250	160	0.0027	AG/A01	4	9	13	10	25	F211AG272(1)250(2)	SMR10272(3)250A01(2)
250	160	0.0033	AG/A01	4	9	13	10	25	F211AG332(1)250(2)	SMR10332(3)250A01(2)
250	160	0.0039	AG/A01	4	9	13	10	25	F211AG392(1)250(2)	SMR10392(3)250A01(2)
250	160	0.0047	AG/A01	4	9	13	10	25	F211AG472(1)250(2)	SMR10472(3)250A01(2)
250	160	0.0056	AG/A01	4	9	13	10	25	F211AG562(1)250(2)	SMR10562(3)250A01(2)
250	160	0.0068	AG/A01	4	9	13	10	25	F211AG682(1)250(2)	SMR10682(3)250A01(2)
250	160	0.0082	AG/A01	4	9	13	10	25	F211AG822(1)250(2)	SMR10822(3)250A01(2)
250	160	0.01	AG/A01	4	9	13	10	15	F211AG103(1)250(2)	SMR10103(3)250A01(2)
250	160	0.012	AG/A01	4	9	13	10	15	F211AG123(1)250(2)	SMR10123(3)250A01(2)
250	160	0.015	AG/A01	4	9	13	10	15	F211AG153(1)250(2)	SMR10153(3)250A01(2)
250	160	0.018	AG/A01	4	9	13	10	15	F211AG183(1)250(2)	SMR10183(3)250A01(2)
250	160	0.022	AG/A01	4	9	13	10	15	F211AG223(1)250(2)	SMR10223(3)250A01(2)
250	160	0.027	AG/A01	4	9	13	10	15	F211AG273(1)250(2)	SMR10273(3)250A01(2)
250	160	0.033	AG/A01	4	9	13	10	15	F211AG333(1)250(2)	SMR10333(3)250A01(2)
250	160	0.039	AG/A01	4	9	13	10	15	F211AG393(1)250(2)	SMR10393(3)250A01(2)
250	160	0.047	AG/A01	4	9	13	10	15	F211AG473(1)250(2)	SMR10473(3)250A01(2)
250	160	0.056	AG/A01	4	9	13	10	15	F211AG563(1)250(2)	SMR10563(3)250A01(2)
250	160	0.068	AG/A01	4	9	13	10	15	F211AG683(1)250(2)	SMR10683(3)250A01(2)
250	160	0.082	AH/A02	4.5	10.5	13	10	15	F211AH823(1)250(2)	SMR10823(3)250A02(2)
250	160	0.1	AH/A02	4.5	10.5	13	10	15	F211AH104(1)250(2)	SMR10104(3)250A02(2)
250	160	0.12	AK/A03	5	11	13	10	15	F211AK124(1)250(2)	SMR10124(3)250A03(2)
250	160	0.15	AP/A04	6	12	13	10	15	F211AP154(1)250(2)	SMR10154(3)250A04(2)
250	160	0.18	AP/A04	6	12	13	10	15	F211AP184(1)250(2)	SMR10184(3)250A04(2)
250	160	0.1	BD/B04	5.5	10.5	18	15	10	F211BD104(1)250(2)	SMR15104(3)250B04(2)
250	160	0.12	BD/B04	5.5	10.5	18	15	10	F211BD124(1)250(2)	SMR15124(3)250B04(2)
250	160	0.15	BD/B04	5.5	10.5	18	15	10	F211BD154(1)250(2)	SMR15154(3)250B04(2)
250	160	0.18	BE/B05	5.5	12.5	18	15	10	F211BE184(1)250(2)	SMR15184(3)250B05(2)
250	160	0.22	BJ/B10	6.5	12.5	18	15	10	F211BJ224(1)250(2)	SMR15224(3)250B10(2)
250	160	0.27	BL/B06	7.5	14.5	18	15	10	F211BL274(1)250(2)	SMR15274(3)250B06(2)
250	160	0.33	BL/B06	7.5	14.5	18	15	10	F211BL334(1)250(2)	SMR15334(3)250B06(2)
250	160	0.39	BM/B12	8	15	18	15	10	F211BM394(1)250(2)	SMR15394(3)250B12(2)
VDC	VAC	Capacitance Value (µF)	Size Code (New/Legacy)	B (mm)	H (mm)	L (mm)	Lead Spacing (p)	dV/dt (V/µs)	New KEMET Part Number	Legacy Part Number

(1) R = ±2.5%, J = ±5%, K = ±10%, M = ±20%
 (2) Insert lead and packaging code. See Ordering Options Table for available options.
 (3) H = ±2.5%, J = ±5%, K = ±10%, M = ±20%

Table 1 – Ratings & Part Number Reference cont'd

VDC	VAC	Capacitance Value (µF)	Size Code (New/Legacy)	Maximum Dimensions in mm			Lead Spacing (p)	dV/dt (V/µs)	New KEMET Part Number	Legacy Part Number
				B	H	L				
250	160	0.47	BQ/B11	8.5	16	18	15	10	F211BQ474(1)250(2)	SMR15474(3)250B11(2)
250	160	0.56	BV/B14	9.5	17.5	18	15	10	F211BV564(1)250(2)	SMR15564(3)250B14(2)
250	160	0.47	DD/D13	6.5	14.5	26	22.5	8	F211DD474(1)250(2)	SMR22.5474(3)250D13(2)
250	160	0.56	DF/D17	7	16.5	26	22.5	8	F211DF564(1)250(2)	SMR22.5564(3)250D17(2)
250	160	0.68	DF/D17	7	16.5	26	22.5	8	F211DF684(1)250(2)	SMR22.5684(3)250D17(2)
250	160	0.82	DM/D15	9	18.5	26	22.5	8	F211DM824(1)250(2)	SMR22.5824(3)250D15(2)
250	160	1	DM/D15	9	18.5	26	22.5	8	F211DM105(1)250(2)	SMR22.5105(3)250D15(2)
250	160	1.2	DR/D18	10.5	19	26	22.5	8	F211DR125(1)250(2)	SMR22.5125(3)250D18(2)
250	160	1.5	DT/D16	11	21.5	26	22.5	8	F211DT155(1)250(2)	SMR22.5155(3)250D16(2)
250	160	1.5	FE/F11	10.5	20.5	31.5	27.5	6	F211FE155(1)250(2)	SMR27.5155(3)250F11(2)
250	160	1.8	FE/F11	10.5	20.5	31.5	27.5	6	F211FE185(1)250(2)	SMR27.5185(3)250F11(2)
250	160	2.2	FG/F12	11.5	22.5	31.5	27.5	6	F211FG225(1)250(2)	SMR27.5225(3)250F12(2)
250	160	2.7	FM/F13	14.5	24.5	31.5	27.5	6	F211FM275(1)250(2)	SMR27.5275(3)250F13(2)
250	160	3.3	FR/F14	17.5	28	31.5	27.5	6	F211FR335(1)250(2)	SMR27.5335(3)250F14(2)
250	160	3.9	FR/F14	17.5	28	31.5	27.5	6	F211FR395(1)250(2)	SMR27.5395(3)250F14(2)
400	200	0.001	JF/J01	2.5	6.5	7.2	5	40	F211JF102(1)400(2)	SMR5102(3)400J01(2)
400	200	0.0012	JF/J01	2.5	6.5	7.2	5	40	F211JF122(1)400(2)	SMR5122(3)400J01(2)
400	200	0.0015	JF/J01	2.5	6.5	7.2	5	40	F211JF152(1)400(2)	SMR5152(3)400J01(2)
400	200	0.0018	JF/J01	2.5	6.5	7.2	5	40	F211JF182(1)400(2)	SMR5182(3)400J01(2)
400	200	0.0022	JF/J01	2.5	6.5	7.2	5	40	F211JF222(1)400(2)	SMR5222(3)400J01(2)
400	200	0.0027	JF/J01	2.5	6.5	7.2	5	40	F211JF272(1)400(2)	SMR5272(3)400J01(2)
400	200	0.0033	JF/J01	2.5	6.5	7.2	5	40	F211JF332(1)400(2)	SMR5332(3)400J01(2)
400	200	0.0039	JF/J01	2.5	6.5	7.2	5	40	F211JF392(1)400(2)	SMR5392(3)400J01(2)
400	200	0.0047	JJ/J02	3.5	8	7.2	5	40	F211JJ472(1)400(2)	SMR5472(3)400J02(2)
400	200	0.0056	JJ/J02	3.5	8	7.2	5	40	F211JJ562(1)400(2)	SMR5562(3)400J02(2)
400	200	0.0068	JJ/J02	3.5	8	7.2	5	40	F211JJ682(1)400(2)	SMR5682(3)400J02(2)
400	200	0.0082	JJ/J02	3.5	8	7.2	5	40	F211JJ822(1)400(2)	SMR5822(3)400J02(2)
400	200	0.01	JJ/J02	3.5	8	7.2	5	40	F211JJ103(1)400(2)	SMR5103(3)400J02(2)
400	200	0.012	JJ/J02	3.5	8	7.2	5	40	F211JJ123(1)400(2)	SMR5123(3)400J02(2)
400	200	0.015	JL/J03	4.5	9	7.2	5	40	F211JL153(1)400(2)	SMR5153(3)400J03(2)
400	200	0.018	JL/J03	4.5	9	7.2	5	40	F211JL183(1)400(2)	SMR5183(3)400J03(2)
400	200	0.022	JQ/J04	5	10	7.2	5	40	F211JQ223(1)400(2)	SMR5223(3)400J04(2)
400	200	0.027	JQ/J04	5	10	7.2	5	40	F211JQ273(1)400(2)	SMR5273(3)400J04(2)
400	200	0.033	JT/J05	6	11	7.2	5	40	F211JT333(1)400(2)	SMR5333(3)400J05(2)
400	200	0.039	JT/J05	6	11	7.2	5	40	F211JT393(1)400(2)	SMR5393(3)400J05(2)
400	200	0.047	JU/J06	7.2	13	7.2	5	40	F211JU473(1)400(2)	SMR5473(3)400J06(2)
400	200	0.056	JU/J06	7.2	13	7.2	5	40	F211JU563(1)400(2)	SMR5563(3)400J06(2)
400	200	0.001	KG/K01	4	8	10	7.5	30	F211KG102(1)400(2)	SMR7.5102(3)400K01(2)
400	200	0.0012	KG/K01	4	8	10	7.5	30	F211KG122(1)400(2)	SMR7.5122(3)400K01(2)
400	200	0.0015	KG/K01	4	8	10	7.5	30	F211KG152(1)400(2)	SMR7.5152(3)400K01(2)
400	200	0.0018	KG/K01	4	8	10	7.5	30	F211KG182(1)400(2)	SMR7.5182(3)400K01(2)
400	200	0.0022	KG/K01	4	8	10	7.5	30	F211KG222(1)400(2)	SMR7.5222(3)400K01(2)
400	200	0.0027	KG/K01	4	8	10	7.5	30	F211KG272(1)400(2)	SMR7.5272(3)400K01(2)
400	200	0.0033	KG/K01	4	8	10	7.5	30	F211KG332(1)400(2)	SMR7.5332(3)400K01(2)
400	200	0.0039	KG/K01	4	8	10	7.5	30	F211KG392(1)400(2)	SMR7.5392(3)400K01(2)
400	200	0.0047	KG/K01	4	8	10	7.5	30	F211KG472(1)400(2)	SMR7.5472(3)400K01(2)
400	200	0.0056	KG/K01	4	8	10	7.5	30	F211KG562(1)400(2)	SMR7.5562(3)400K01(2)
400	200	0.0068	KG/K01	4	8	10	7.5	30	F211KG682(1)400(2)	SMR7.5682(3)400K01(2)
400	200	0.0082	KG/K01	4	8	10	7.5	30	F211KG822(1)400(2)	SMR7.5822(3)400K01(2)
400	200	0.01	KG/K01	4	8	10	7.5	30	F211KG103(1)400(2)	SMR7.5103(3)400K01(2)
400	200	0.012	KG/K01	4	8	10	7.5	30	F211KG123(1)400(2)	SMR7.5123(3)400K01(2)
400	200	0.015	KG/K01	4	8	10	7.5	30	F211KG153(1)400(2)	SMR7.5153(3)400K01(2)
400	200	0.018	KG/K01	4	8	10	7.5	30	F211KG183(1)400(2)	SMR7.5183(3)400K01(2)
400	200	0.022	KG/K01	4	8	10	7.5	30	F211KG223(1)400(2)	SMR7.5223(3)400K01(2)
400	200	0.027	KK/K03	5	11	10	7.5	30	F211KK273(1)400(2)	SMR7.5273(3)400K03(2)
400	200	0.033	KK/K03	5	11	10	7.5	30	F211KK333(1)400(2)	SMR7.5333(3)400K03(2)
VDC	VAC	Capacitance Value (µF)	Size Code (New/Legacy)	B (mm)	H (mm)	L (mm)	Lead Spacing (p)	dV/dt (V/µs)	New KEMET Part Number	Legacy Part Number

(1) R = ±2.5%, J = ±5%, K = ±10%, M = ±20%
 (2) Insert lead and packaging code. See Ordering Options Table for available options.
 (3) H = ±2.5%, J = ±5%, K = ±10%, M = ±20%

Table 1 – Ratings & Part Number Reference cont'd

VDC	VAC	Capacitance Value (µF)	Size Code (New/Legacy)	Maximum Dimensions in mm			Lead Spacing (p)	dV/dt (V/µs)	New KEMET Part Number	Legacy Part Number
				B	H	L				
400	200	0.039	KK/K03	5	11	10	7.5	30	F211KK393(1)400(2)	SMR7.5393(3)400K03(2)
400	200	0.047	KK/K03	5	11	10	7.5	30	F211KK473(1)400(2)	SMR7.5473(3)400K03(2)
400	200	0.056	KM/K04	6	12	10.5	7.5	30	F211KM563(1)400(2)	SMR7.5563(3)400K04(2)
400	200	0.068	KM/K04	6	12	10.5	7.5	30	F211KM683(1)400(2)	SMR7.5683(3)400K04(2)
400	200	0.0027	AG/A01	4	9	13	10	25	F211AG272(1)400(2)	SMR10272(3)400A01(2)
400	200	0.0033	AG/A01	4	9	13	10	25	F211AG332(1)400(2)	SMR10332(3)400A01(2)
400	200	0.0039	AG/A01	4	9	13	10	25	F211AG392(1)400(2)	SMR10392(3)400A01(2)
400	200	0.0047	AG/A01	4	9	13	10	25	F211AG472(1)400(2)	SMR10472(3)400A01(2)
400	200	0.0068	AG/A01	4	9	13	10	25	F211AG682(1)400(2)	SMR10682(3)400A01(2)
400	200	0.0082	AG/A01	4	9	13	10	25	F211AG822(1)400(2)	SMR10822(3)400A01(2)
400	200	0.01	AG/A01	4	9	13	10	25	F211AG103(1)400(2)	SMR10103(3)400A01(2)
400	200	0.012	AG/A01	4	9	13	10	25	F211AG123(1)400(2)	SMR10123(3)400A01(2)
400	200	0.015	AG/A01	4	9	13	10	25	F211AG153(1)400(2)	SMR10153(3)400A01(2)
400	200	0.018	AG/A01	4	9	13	10	25	F211AG183(1)400(2)	SMR10183(3)400A01(2)
400	200	0.022	AG/A01	4	9	13	10	25	F211AG223(1)400(2)	SMR10223(3)400A01(2)
400	200	0.027	AG/A01	4	9	13	10	25	F211AG273(1)400(2)	SMR10273(3)400A01(2)
400	200	0.033	AG/A01	4	9	13	10	25	F211AG333(1)400(2)	SMR10333(3)400A01(2)
400	200	0.039	AH/A02	4.5	10.5	13	10	25	F211AH393(1)400(2)	SMR10393(3)400A02(2)
400	200	0.047	AK/A03	5	11	13	10	25	F211AK473(1)400(2)	SMR10473(3)400A03(2)
400	200	0.056	AK/A03	5	11	13	10	25	F211AK563(1)400(2)	SMR10563(3)400A03(2)
400	200	0.068	AP/A04	6	12	13	10	25	F211AP683(1)400(2)	SMR10683(3)400A04(2)
400	200	0.082	AP/A04	6	12	13	10	25	F211AP823(1)400(2)	SMR10823(3)400A04(2)
400	200	0.047	BD/B04	5.5	10.5	18	15	15	F211BD473(1)400(2)	SMR15473(3)400B04(2)
400	200	0.056	BD/B04	5.5	10.5	18	15	15	F211BD563(1)400(2)	SMR15563(3)400B04(2)
400	200	0.068	BD/B04	5.5	10.5	18	15	15	F211BD683(1)400(2)	SMR15683(3)400B04(2)
400	200	0.082	BE/B05	5.5	12.5	18	15	15	F211BE823(1)400(2)	SMR15823(3)400B05(2)
400	200	0.1	BJ/B10	6.5	12.5	18	15	15	F211BJ104(1)400(2)	SMR15104(3)400B10(2)
400	200	0.12	BL/B06	7.5	14.5	18	15	15	F211BL124(1)400(2)	SMR15124(3)400B06(2)
400	200	0.15	BL/B06	7.5	14.5	18	15	15	F211BL154(1)400(2)	SMR15154(3)400B06(2)
400	200	0.18	BM/B12	8	15	18	15	15	F211BM184(1)400(2)	SMR15184(3)400B12(2)
400	200	0.22	BQ/B11	8.5	16	18	15	15	F211BQ224(1)400(2)	SMR15224(3)400B11(2)
400	200	0.27	BV/B14	9.5	17.5	18	15	15	F211BV274(1)400(2)	SMR15274(3)400B14(2)
400	200	0.15	DD/D13	6.5	14.5	26	22.5	10	F211DD154(1)400(2)	SMR22.5154(3)400D13(2)
400	200	0.18	DD/D13	6.5	14.5	26	22.5	10	F211DD184(1)400(2)	SMR22.5184(3)400D13(2)
400	200	0.22	DD/D13	6.5	14.5	26	22.5	10	F211DD224(1)400(2)	SMR22.5224(3)400D13(2)
400	200	0.27	DF/D17	7	16.5	26	22.5	10	F211DF274(1)400(2)	SMR22.5274(3)400D17(2)
400	200	0.33	DH/D14	8	16	26	22.5	10	F211DH334(1)400(2)	SMR22.5334(3)400D14(2)
400	200	0.39	DM/D15	9	18.5	26	22.5	10	F211DM394(1)400(2)	SMR22.5394(3)400D15(2)
400	200	0.47	DM/D15	9	18.5	26	22.5	10	F211DM474(1)400(2)	SMR22.5474(3)400D15(2)
400	200	0.56	DR/D18	10.5	19	26	22.5	10	F211DR564(1)400(2)	SMR22.5564(3)400D18(2)
400	200	0.68	DT/D16	11	21.5	26	22.5	10	F211DT684(1)400(2)	SMR22.5684(3)400D16(2)
400	200	0.47	FE/F11	10.5	20.5	31.5	27.5	8	F211FE474(1)400(2)	SMR27.5474(3)400F11(2)
400	200	0.56	FE/F11	10.5	20.5	31.5	27.5	8	F211FE564(1)400(2)	SMR27.5564(3)400F11(2)
400	200	0.68	FE/F11	10.5	20.5	31.5	27.5	8	F211FE684(1)400(2)	SMR27.5684(3)400F11(2)
400	200	0.82	FG/F12	11.5	22.5	31.5	27.5	8	F211FG824(1)400(2)	SMR27.5824(3)400F12(2)
400	200	1	FG/F12	11.5	22.5	31.5	27.5	8	F211FG105(1)400(2)	SMR27.5105(3)400F12(2)
400	200	1.2	FM/F13	14.5	24.5	31.5	27.5	8	F211FM125(1)400(2)	SMR27.5125(3)400F13(2)
400	200	1.5	FR/F14	17.5	28	31.5	27.5	8	F211FR155(1)400(2)	SMR27.5155(3)400F14(2)
400	200	1.8	FR/F14	17.5	28	31.5	27.5	8	F211FR185(1)400(2)	SMR27.5185(3)400F14(2)
VDC	VAC	Capacitance Value (µF)	Size Code (New/Legacy)	B (mm)	H (mm)	L (mm)	Lead Spacing (p)	dV/dt (V/µs)	New KEMET Part Number	Legacy Part Number

- (1) R = ±2.5%, J = ±5%, K = ±10%, M = ±20%
- (2) Insert lead and packaging code. See Ordering Options Table for available options.
- (3) H = ±2.5%, J = ±5%, K = ±10%, M = ±20%

Soldering Process

The implementation of the RoHS directive has resulted in the selection of SnAuCu (SAC) alloys or SnCu alloys as primary solder. This has increased the liquidus temperature from that of 183°C for SnPb eutectic alloy to 217 – 221°C for the new alloys. As a result, the heat stress to the components, even in wave soldering, has increased considerably due to higher pre-heat and wave temperatures. Polypropylene capacitors are especially sensitive to heat (the melting point of polypropylene is 160 – 170°C). Wave soldering can be destructive, especially for mechanically small polypropylene capacitors (with lead spacing of 5 – 15 mm), and great care has to be taken during soldering. In general, the wave soldering curve from IEC Publication 61760-1 Edition 2 serves as a solid guideline for successful soldering. Please see Figure 1. The recommended solder profiles from KEMET should be used. Please consult KEMET with any questions.

Reflow soldering is not recommended for through-hole film capacitors. Exposing capacitors to a soldering profile in excess of the above the recommended limits may result to degradation or permanent damage to the capacitors.

Do not place the polypropylene capacitor through an adhesive curing oven to cure resin for surface mount components. Insert through-hole parts after the curing of surface mount parts. Consult KEMET to discuss the actual temperature profile in the oven, if through-hole components must pass through the adhesive curing process. A maximum two soldering cycles is recommended. Please allow time for the capacitor surface temperature to return to a normal temperature before the second soldering cycle.

Manual Soldering Recommendations

Following is the recommendation for manual soldering with a soldering iron.

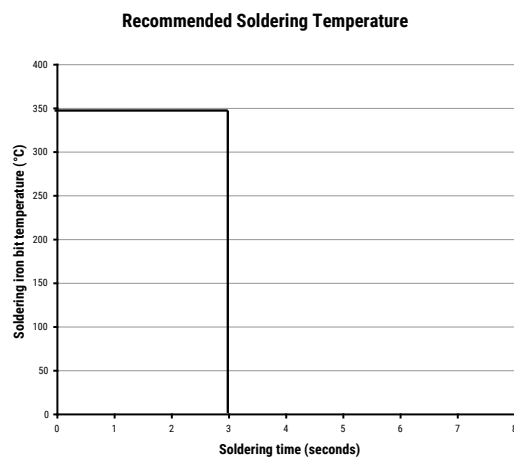

Soldering iron tip temperature should be set at 350°C (+10°C maximum) with the soldering duration not to exceed more than three seconds.

Wave Soldering Recommendations

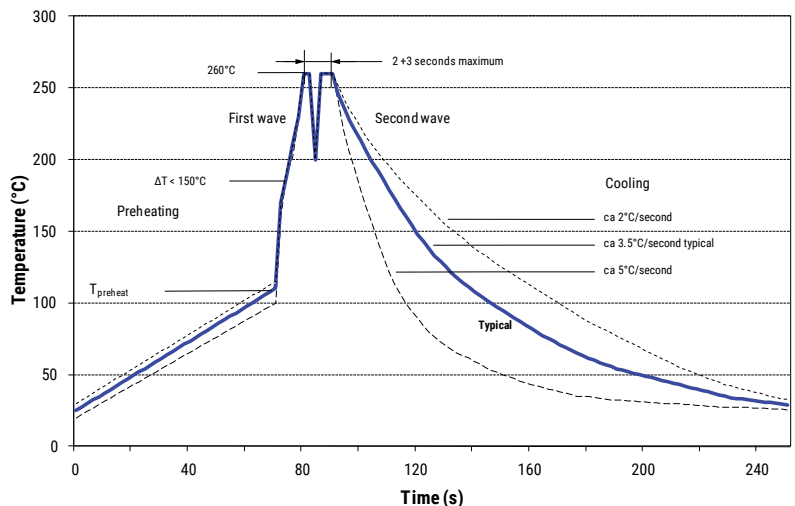

Soldering Process cont'd

Wave Soldering Recommendations cont'd

1. The table indicates the maximum set-up temperature of the soldering process
 Figure 1

Dielectric Film Material	Maximum Preheat Temperature			Maximum Peak Soldering Temperature	
	Capacitor pitch ≤ 10 mm	Capacitor pitch = 15 mm	Capacitor pitch > 15 mm	Capacitor pitch ≤ 15 mm	Capacitor pitch > 15 mm
Polyester	130°C	130°C	130°C	270°C	270°C
Polypropylene	100°C	110°C	130°C	260°C	270°C
Paper	130°C	130°C	140°C	270°C	270°C
Polyphenylene Sulphide	150°C	150°C	160°C	270°C	270°C

2. The maximum temperature measured inside the capacitor:
 Set the temperature so that inside the element the maximum temperature is below the limit:

Dielectric Film Material	Maximum temperature measured inside the element
Polyester	160°C
Polypropylene	110°C
Paper	160°C
Polyphenylene Sulphide	160°C

Temperature monitored inside the capacitor.

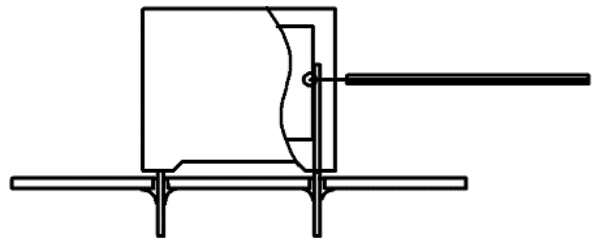

Selective Soldering Recommendations

Selective dip soldering is a variation of reflow soldering. In this method, the printed circuit board with through-hole components to be soldered is preheated and transported over the solder bath as in normal flow soldering without touching the solder. When the board is over the bath, it is stopped, and pre-designed solder pots are lifted from the bath with molten solder only at the places of the selected components and pressed against the lower surface of the board to solder the components.

The temperature profile for selective soldering is similar to the double wave flow soldering outlined in this document; **however, instead of two baths, there is only one bath with a time of 3 to 10 seconds.** In selective soldering, the risk of overheating is greater than in double wave flow soldering, and great care must be taken so that the parts are not overheated.

Construction

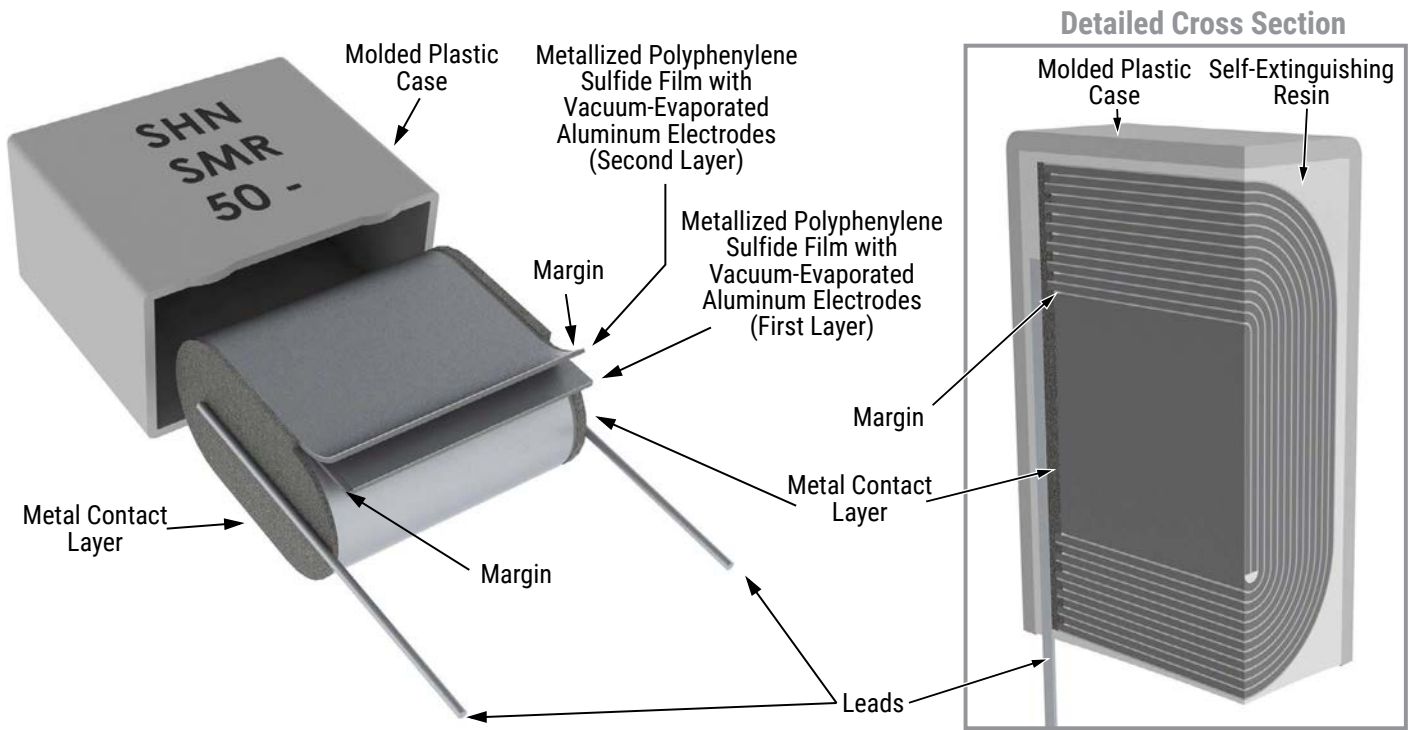

Winding Scheme

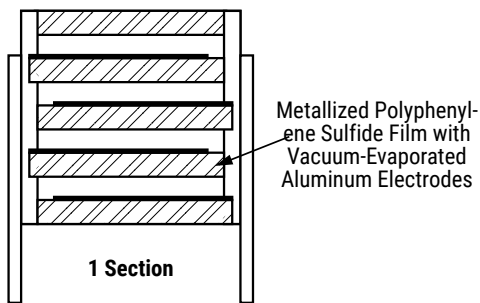

Marking

Lead Spacing 5 mm

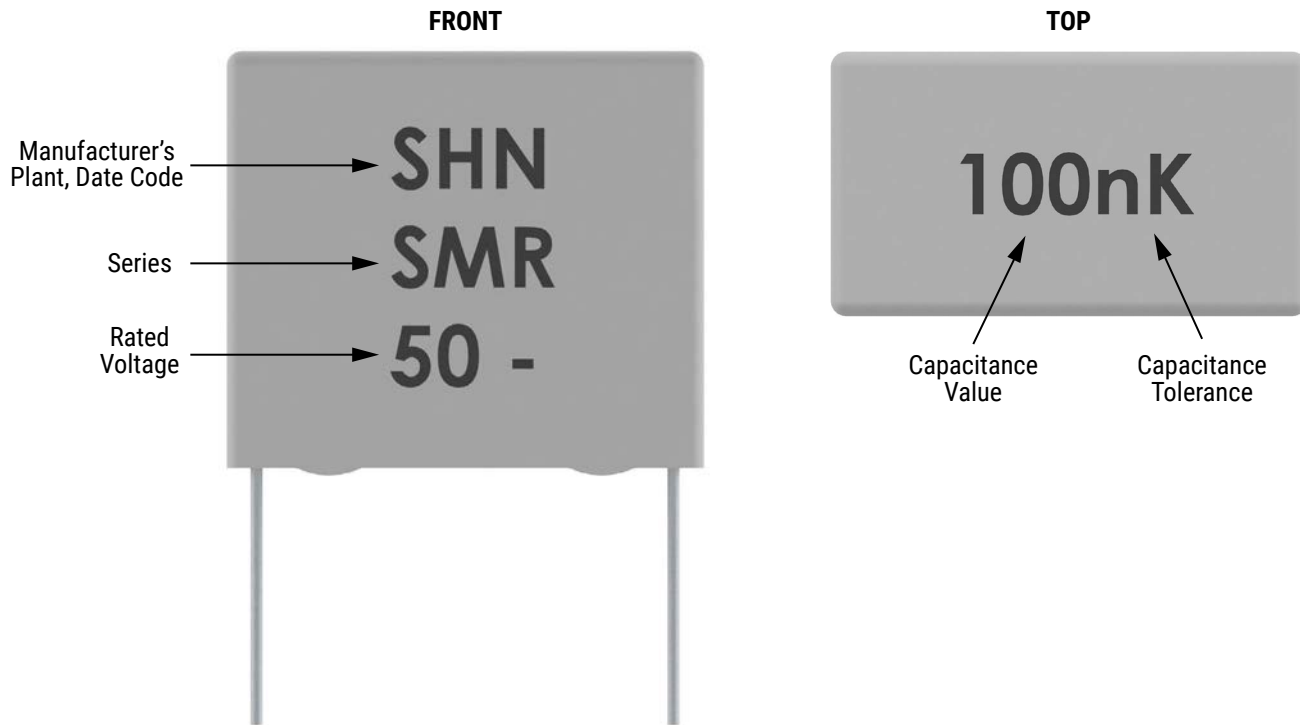

Lead Spacing 7.5 – 22.5 mm

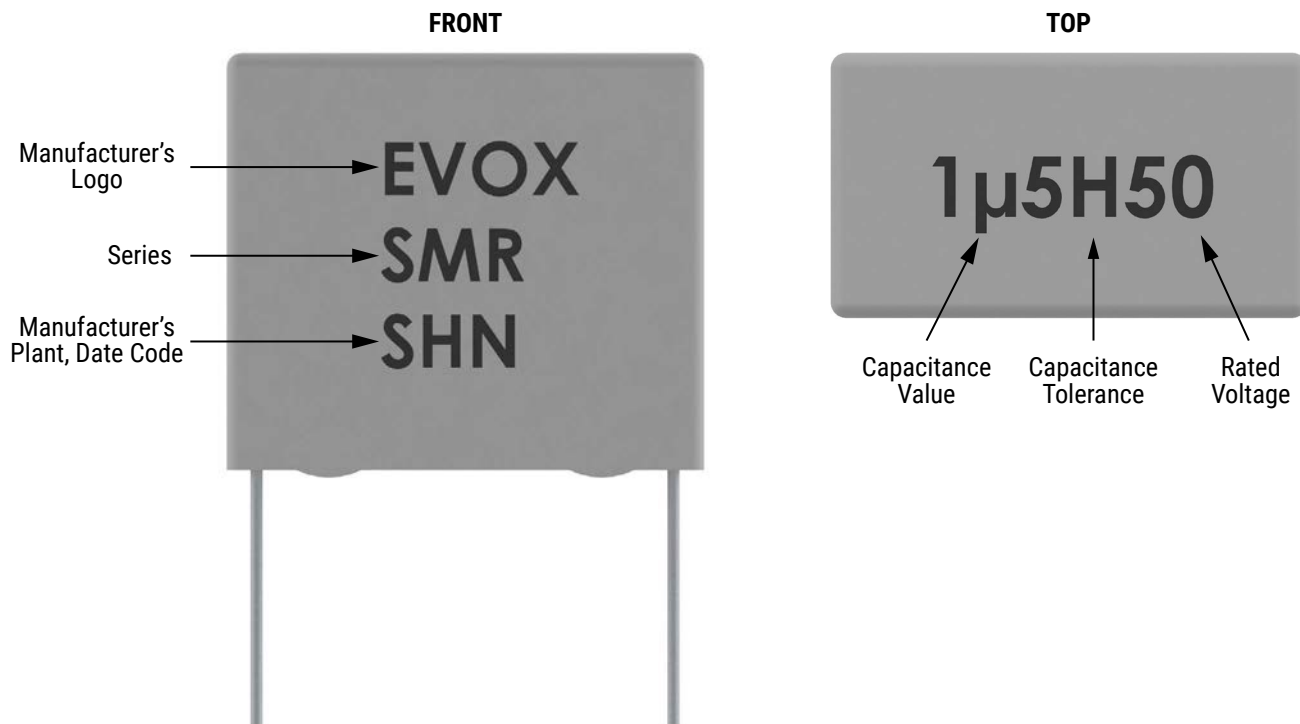

Marking

Lead Spacing ≥ 27.5 mm

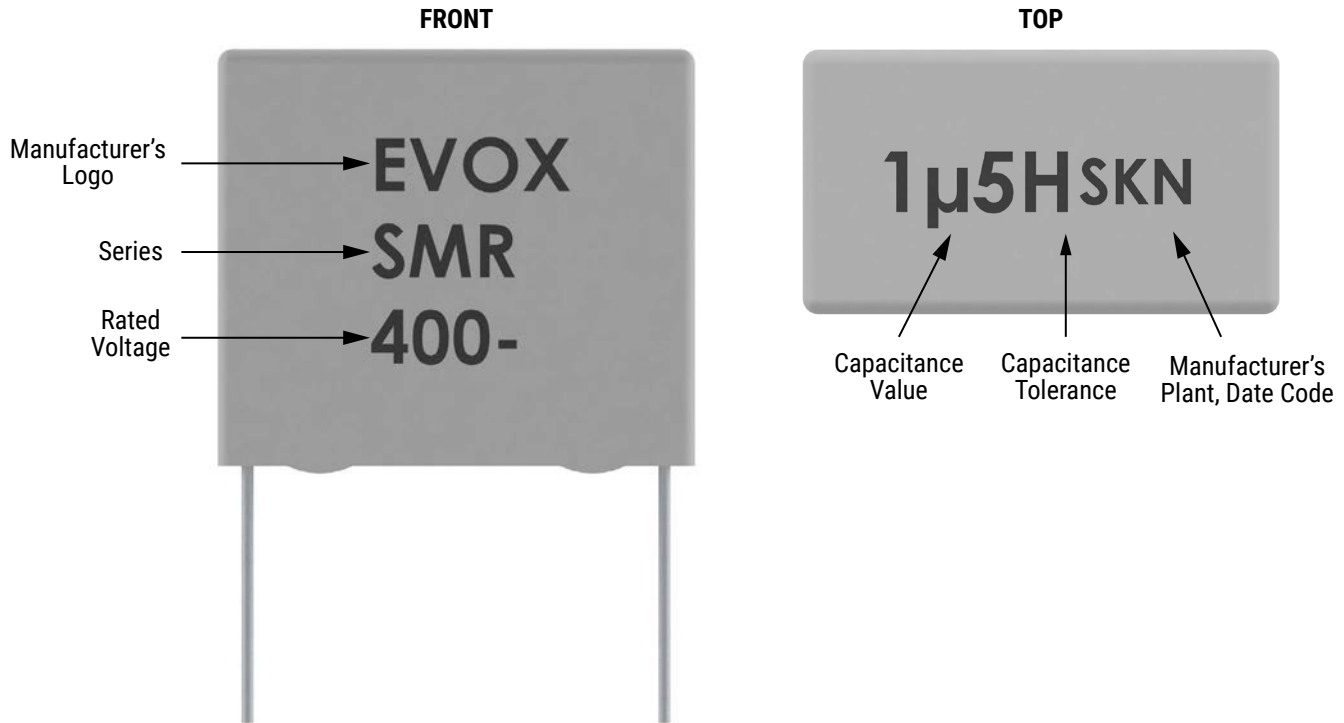

Packaging Quantities

KEMET Size Code	Legacy Size Code	Lead Spacing	Thickness (mm)	Height (mm)	Length (mm)	Bulk Short Leads	Bulk Long Leads	Standard Reel 360 mm	Large Reel 500 mm	Ammo	Standard Reel Formed	Ammo Formed
JF	J01	5.0	2.5	6.5	7.2	2,000	2,000	2,500	5,000	3,000		
JJ	J02		3.5	8.0	7.2	2,000	2,000	2,000	4,000	2,000		
JL	J03		4.5	9.0	7.2	1,000	1,000	1,500	3,000	1,700		
JQ	J04		5.0	10.0	7.2	1,000	1,000	1,300	2,600	1,500		
JT	J05		6.0	11.0	7.2	1,000	1,000	1,000	2,000	1,200		
JU	J06		7.2	13.0	7.2	1,000	1,000	800	1,600			
KE	K00	7.5	2.5	6.0	10.0	2,000	2,000	2,500	5,000	3,000		
KG	K01		4.0	8.0	10.0	1,000	1,000	1,700	3,400	1,900		
KK	K03		5.0	11.0	10.0	1,000	1,000	1,300	2,600	1,500		1,200
KM	K04		6.0	12.0	10.0	1,000	1,000	1,000	2,000	1,200		

Packaging Quantities cont'd

KEMET Size Code	Legacy Size Code	Lead Spacing	Thickness (mm)	Height (mm)	Length (mm)	Bulk Short Leads	Bulk Long Leads	Standard Reel 360 mm	Large Reel 500 mm	Ammo	Standard Reel Formed	Ammo Formed
AG	A01	10	4.0	9.0	13.0	1,000	1,000	900	1,800			630
AH	A02		4.5	10.5	13.0	1,000	1,000	800	1,600			630
AK	A03		5.0	11.0	13.0	800	800	700	1,400			
AP	A04		6.0	12.0	13.0	600	600	500	1,000			520
AL	A05		9.5	7.5	13.0	600	600	350	700			
AE	A06		4.0	8.0	13.0	1,000	1,000	900	1,800			
BD	B04	15	5.5	10.5	18.0	1,000	800	600	1,200		550	570
BE	B05		5.5	12.5	18.0	1,000	800	600	1,200		550	570
BL	B06		7.5	14.5	18.0	800	400	400	800		400	378
BJ	B10		6.5	12.5	18.0	1,000	600	500	1,000		450	480
BQ	B11		8.5	16.0	18.0	600	400	400	800		400	324
BM	B12		8.0	15.0	18.0	600	400	400	800		350	351
BV	B14		9.5	17.5	18.0	500	300	350	700		250	297
BG	B15		6.0	12.0	18.0	1,000	800	500	1,000		450	520
BY	B16		11.0	19.0	18.0	350	250	250	500		250	252
BU	B17		13.0	12.5	18.0	400	300	250	500		200	216
DD	D13	22.5	6.5	14.5	26.5	234		300	600			
DH	D14		8.0	16.0	26.5	186		250	500			
DM	D15		9.0	18.5	26.5	308		250	500			
DT	D16		11.0	21.5	26.5	253		200	400			
DF	D17		7.0	16.5	26.5	216		300	600			
DR	D18		10.5	19.0	26.5	264		200	400			
DY	D19		15.5	24.5	26.5	176		110	250			
DW	D20		13.5	23.0	26.5	209		160	300			
FK	F03	27.5	13.5	23.0	31.5	171			250			
FE	F11		10.5	20.5	31.5	216			350			
FG	F12		11.5	22.5	31.5	198			300			
FM	F13		14.5	24.5	31.5	153			250			
FR	F14		17.5	28.0	31.5	126						
FS	F15		19.0	29.0	31.5	117						
FV	F16		21.0	30.0	31.5	108						
FH	F17		21.0	12.5	31.5	108						
FT	F18		31.0	18.5	31.5	72						
FQ	F19		27.5	16.0	31.5	81						

Lead Taping & Packaging (IEC 60286-2)



Taping Specification

Dimensions in mm										Standard IEC 60286-2
Lead Spacing	+6/-0.1	F	5	7.5	Formed 7.5	10	15	22.5	27.5	F
Carrier Tape Width	±0.5	W	18	18	18	18	18	18	18	18 +1/-0.5
Hold-down Tape Width	Minimum	W ₀	5	5	5	5	5	5	5	
Position of Sprocket Hole	±0.5	W ₁	9	9	9	9	9	9	9	9 +0.75/-0.5
Distance Between Tapes	Maximum	W ₂	3	3	3	3	3	3	3	3
Sprocket Hole Diameter	±0.2	D ₀	4	4	4	4	4	4	4	4
Feed Hole Lead Spacing	±0.3	P ₀ (1)	12.7	12.7	12.7 (4)	12.7	12.7	12.7	12.7	12.7
Distance Lead – Feed Hole	±0.7	P ₁	3.85	3.75	3.75	7.7	5.2	5.3	5.3	P1
Deviation Tape – Plane	Maximum	Δ p	1.3	1.3	1.3	1.3	1.3	1.3	1.3	1.3
Lateral Deviation	Maximum	Δ h	2	2	2	2	2	2	2	2
Total Thickness	±0.2	t	0.7	0.7	0.7	0.7	0.7	0.9 maximum	0.9 maximum	0.9 maximum
Sprocket Hole/Cap Body	Nominal	H ₀ (2)	18.5±0.5	18.5±0.5	18.5±0.5	18.5±0.5	18.5±0.5	18.5±0.5	18.5±0.5	18.0 +2/-0
Sprocket Hole/Top of Cap Body	Maximum	H ₁ (3)	32	31	43	43	43	58	58	58 maximum

(1) Maximum cumulative feed hole error, 1 mm per 20 parts

(2) 16.5 mm available on request

(3) Depending on case size

(4) 15 mm available on request

Lead Taping & Packaging (IEC 60286-2) cont'd

Ammo Specifications

Series	Dimensions (mm)		
	H	W	T
R4x, R4x+R, R7x, RSB	360	340	59
F5A, F5B, F5D			
F6xx, F8xx			
PHExxx, PMExxx, PMRxxx, SMR & PFR	330	330	50



Reel Specifications

Series	Dimensions (mm)		
	D	H	W
R4x, R4x+R, R7x, RSB	355 500	30	55 (Max)
F5A, F5B, F5D		25	
F6xx, F8xx			
PHExxx, PMExxx, PMRxxx, SMR & PFR	360 500	30	46 (Max)



Manufacturing Date Code (IEC-60062)

Y = Year, Z = Month			
Year	Code	Month	Code
2010	A	January	1
2011	B	February	2
2012	C	March	3
2013	D	April	4
2014	E	May	5
2015	F	June	6
2016	H	July	7
2017	J	August	8
2018	K	September	9
2019	L	October	0
2020	M	November	N
2021	N	December	D
2022	P		
2023	R		
2024	S		
2025	T		
2026	U		
2027	V		
2028	W		
2029	X		
2030	A		

KEMET Electronics Corporation Sales Offices

For a complete list of our global sales offices, please visit www.kemet.com/sales.

Disclaimer

All product specifications, statements, information and data (collectively, the "Information") in this datasheet are subject to change. The customer is responsible for checking and verifying the extent to which the Information contained in this publication is applicable to an order at the time the order is placed. All Information given herein is believed to be accurate and reliable, but it is presented without guarantee, warranty, or responsibility of any kind, expressed or implied.

Statements of suitability for certain applications are based on KEMET Electronics Corporation's ("KEMET") knowledge of typical operating conditions for such applications, but are not intended to constitute – and KEMET specifically disclaims – any warranty concerning suitability for a specific customer application or use. The Information is intended for use only by customers who have the requisite experience and capability to determine the correct products for their application. Any technical advice inferred from this Information or otherwise provided by KEMET with reference to the use of KEMET's products is given gratis, and KEMET assumes no obligation or liability for the advice given or results obtained.

Although KEMET designs and manufactures its products to the most stringent quality and safety standards, given the current state of the art, isolated component failures may still occur. Accordingly, customer applications which require a high degree of reliability or safety should employ suitable designs or other safeguards (such as installation of protective circuitry or redundancies) in order to ensure that the failure of an electrical component does not result in a risk of personal injury or property damage.

Although all product-related warnings, cautions and notes must be observed, the customer should not assume that all safety measures are indicated or that other measures may not be required.

KEMET is a registered trademark of KEMET Electronics Corporation.