

N-channel 525 V, 1 Ω typ., 6.5 A MDmesh™ K3 Power MOSFET in DPAK package

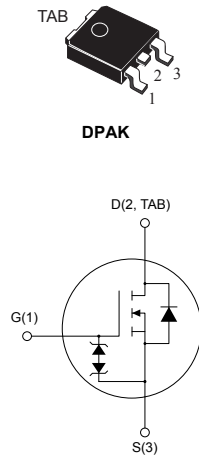

Features

Order codes	V_{DS}	$R_{DS(on)}$ max.	I_D	P_{TOT}
STD6N52K3	525 V	1.2 Ω	5 A	70 W

- 100% avalanche tested
- Extremely high dv/dt capability
- Very low intrinsic capacitance
- Improved diode reverse recovery characteristics
- Zener-protected

Applications

- Switching applications

Description

This MDmesh™ K3 Power MOSFET is the result of improvements applied to STMicroelectronics' MDmesh™ technology, combined with a new optimized vertical structure. This device boasts an extremely low on-resistance, superior dynamic performance and high avalanche capability, rendering it suitable for the most demanding applications.

Product status link

[STD6N52K3](#)

Product summary

Order code	STD6N52K3
Marking	6N52K3
Package	DPAK
Packing	Tape and reel

1 Electrical ratings

Table 1. Absolute maximum ratings

Symbol	Parameter	Value	Unit
V_{GS}	Gate- source voltage	± 30	V
I_D	Drain current (continuous) at $T_C = 25\text{ }^\circ\text{C}$	5	A
I_D	Drain current (continuous) at $T_C = 100\text{ }^\circ\text{C}$	3	A
$I_{DM}^{(1)}$	Drain current (pulsed)	20	A
P_{TOT}	Total dissipation at $T_C = 25\text{ }^\circ\text{C}$	70	W
I_{AR}	Avalanche current, repetitive or not-repetitive	2.5	A
$E_{AS}^{(2)}$	Single pulse avalanche energy	110	mJ
$dv/dt^{(3)}$	Peak diode recovery voltage slope	12	V/ns
T_{stg}	Storage temperature range	-55 to 150	$^\circ\text{C}$
T_j	Operating junction temperature range		

1. Pulse width limited by safe operating area.
2. Starting $T_j = 25\text{ }^\circ\text{C}$, $I_D = I_{AR}$, $V_{DD} = 50\text{ V}$.
3. $I_{SD} \leq 5\text{ A}$, $di/dt \leq 400\text{ A}/\mu\text{s}$, $V_{DD} = 80\% V_{(BR)DSS}$, $V_{DS\ peak} \leq V_{(BR)DSS}$.

Table 2. Thermal data

Symbol	Parameter	Value	Unit
$R_{thj-case}$	Thermal resistance junction-case	1.79	$^\circ\text{C}/\text{W}$
$R_{thj-pcb}^{(1)}$	Thermal resistance junction-pcb	50	$^\circ\text{C}/\text{W}$

1. When mounted on 1inch² FR-4 board, 2 oz Cu.

2 Electrical characteristics

($T_C = 25\text{ °C}$ unless otherwise specified)

Table 3. On /off states

Symbol	Parameter	Test conditions	Min.	Typ.	Max.	Unit
$V_{(BR)DSS}$	Drain-source breakdown voltage	$I_D = 1\text{ mA}$, $V_{GS} = 0\text{ V}$	525			V
I_{DSS}	Zero gate voltage drain current	$V_{GS} = 0\text{ V}$, $V_{DS} = 525\text{ V}$			1	μA
		$V_{GS} = 0\text{ V}$, $V_{DS} = 525\text{ V}$ $T_C = 125\text{ °C}$ ⁽¹⁾			50	μA
I_{GSS}	Gate body leakage current	$V_{GS} = \pm 20\text{ V}$, $V_{DS} = 0\text{ V}$			± 10	μA
$V_{GS(th)}$	Gate threshold voltage	$V_{DS} = V_{GS}$, $I_D = 50\text{ }\mu\text{A}$	3	3.75	4.5	V
$R_{DS(on)}$	Static drain-source on resistance	$V_{GS} = 10\text{ V}$, $I_D = 2.5\text{ A}$		1	1.2	Ω

1. Defined by design, not subject to production test.

Table 4. Dynamic

Symbol	Parameter	Test conditions	Min.	Typ.	Max.	Unit
C_{iss}	Input capacitance	$V_{DS} = 50\text{ V}$, $f = 1\text{ MHz}$, $V_{GS} = 0\text{ V}$	-	670	-	μF
C_{oss}	Output capacitance			54		
C_{rss}	Reverse transfer capacitance			10		
$C_{oss\text{ eq.}}^{(1)}$	Equivalent output capacitance	$V_{GS} = 0\text{ V}$, $V_{DS} = 0\text{ to }420\text{ V}$		40		μF
R_G	Intrinsic gate resistance	$f = 1\text{ MHz}$ open drain	-	4	-	Ω
Q_g	Total gate charge	$V_{DD} = 420\text{ V}$, $I_D = 5\text{ A}$, $V_{GS} = 0\text{ to }10\text{ V}$ (see Figure 15. Test circuit for gate charge behavior)	-	26	-	nC
Q_{gs}	Gate-source charge			4		
Q_{gd}	Gate-drain charge			15		

1. $C_{oss\text{ eq.}}$ is defined as a constant equivalent capacitance giving the same charging time as C_{oss} when V_{DS} increases from 0 to 80% V_{DSS} .

Table 5. Switching times

Symbol	Parameter	Test conditions	Min.	Typ.	Max.	Unit
$t_{d(on)}$	Turn-on delay time	$V_{DD} = 260\text{ V}$, $I_D = 2.5\text{ A}$, $R_G = 4.7\text{ }\Omega$, $V_{GS} = 10\text{ V}$ (see Figure 14. Test circuit for resistive load switching times and Figure 19. Switching time waveform)	-	10	-	ns
t_r	Rise time			11		
$t_{d(off)}$	Turn-off delay time			31		
t_f	Fall time			18		

Table 6. Source drain diode

Symbol	Parameter	Test conditions	Min.	Typ.	Max.	Unit	
I_{SD}	Source-drain current		-		5	A	
$I_{SDM}^{(1)}$	Source-drain current (pulsed)				20		
$V_{SD}^{(2)}$	Forward on voltage	$I_{SD} = 5\text{ A}$, $V_{GS} = 0\text{ V}$	-		1.5	V	
t_{rr}	Reverse recovery time	$I_{SD} = 5\text{ A}$, $di/dt = 100\text{ A}/\mu\text{s}$ $V_{DD} = 60\text{ V}$ (see Figure 16. Test circuit for inductive load switching and diode recovery times)	-	206		ns	
Q_{rr}	Reverse recovery charge			1.4			μC
I_{RRM}	Reverse recovery current			14			
t_{rr}	Reverse recovery time	$I_{SD} = 5\text{ A}$, $di/dt = 100\text{ A}/\mu\text{s}$ $V_{DD} = 60\text{ V}$, $T_j = 150\text{ °C}$ (see Figure 16. Test circuit for inductive load switching and diode recovery times)	-	233		ns	
Q_{rr}	Reverse recovery charge			1.7			μC
I_{RRM}	Reverse recovery current			15			

1. Pulse width limited by safe operating area.
2. Pulsed: pulse duration = 300 μs, duty cycle 1.5%.

Table 7. Gate-source Zener diode

Symbol	Parameter	Test conditions	Min.	Typ.	Max.	Unit
$V_{(BR)GSO}$	Gate-source breakdown voltage	$I_D = 0\text{ A}$, $I_{GS} = \pm 1\text{ mA}$	±30	-		V

The built-in back-to-back Zener diodes are specifically designed to enhance the ESD performance of the device. The Zener voltage facilitates efficient and cost-effective device integrity protection, thus eliminating the need for additional external componentry.

2.1 Electrical characteristics curves

Figure 1. Safe operating area

Figure 2. Thermal impedance

Figure 3. Output characteristics

Figure 4. Transfer characteristics

Figure 5. Gate charge vs gate-source voltage

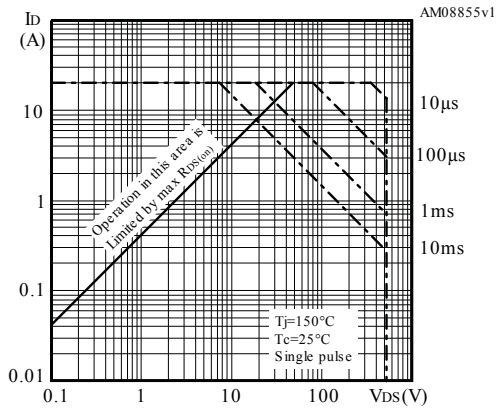
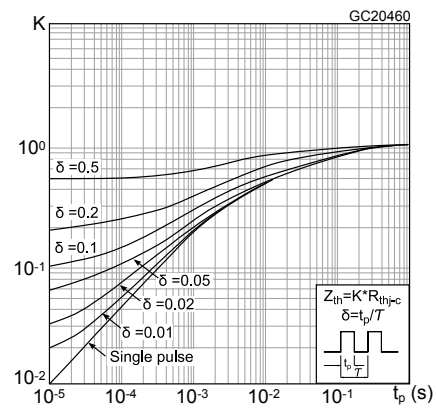
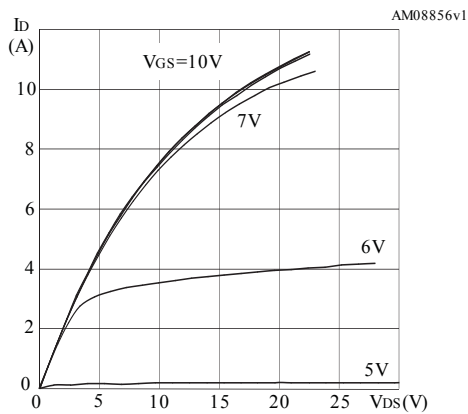
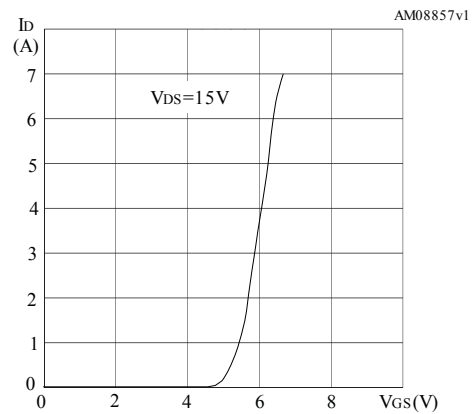
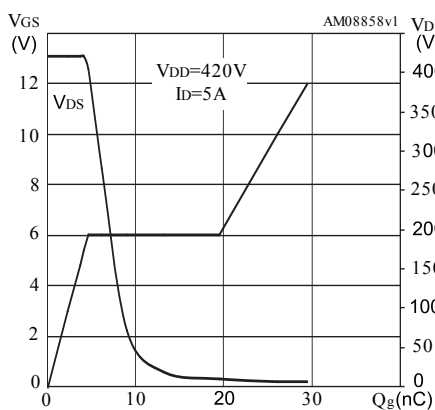
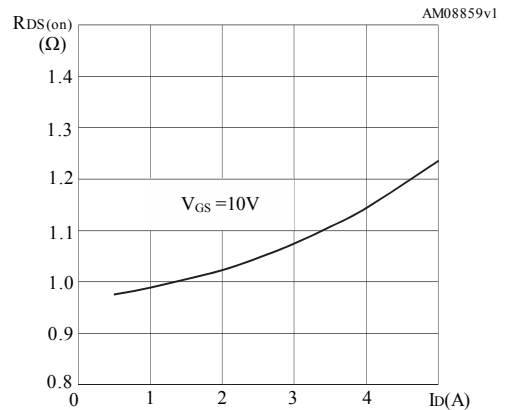
Figure 6. Static drain-source on resistance

Figure 7. Capacitance variations

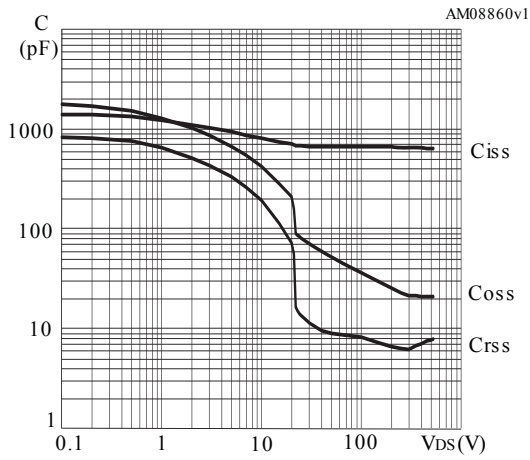

Figure 8. Output capacitance stored energy

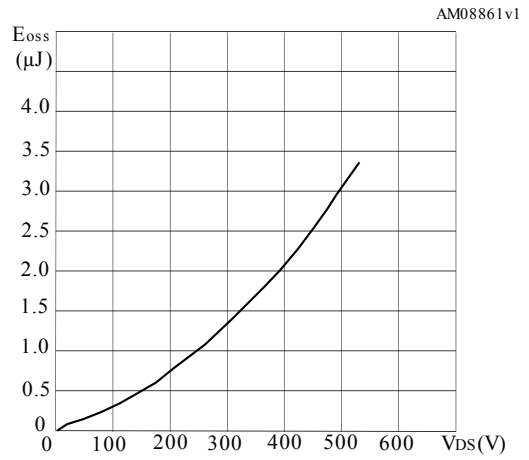

Figure 9. Normalized gate threshold voltage vs temperature

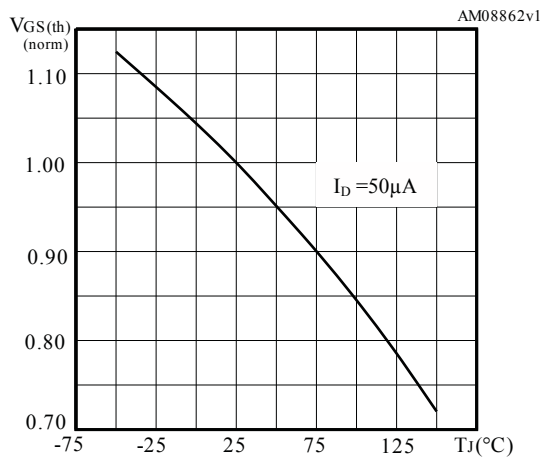

Figure 10. Normalized on resistance vs temperature

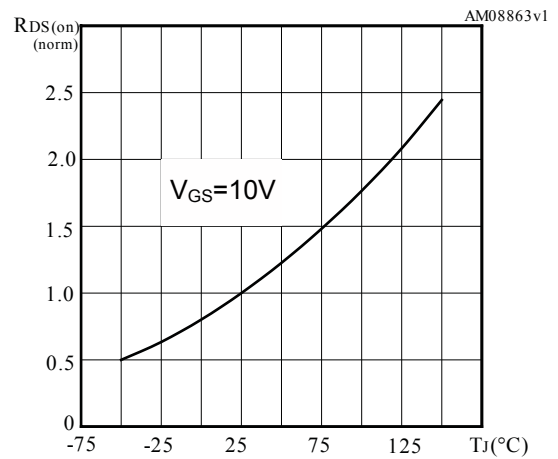

Figure 11. Source-drain diode forward characteristics

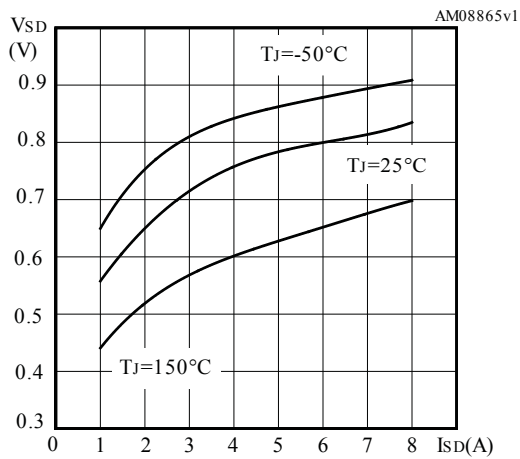

Figure 12. Normalized V_{(BR)DSS} vs temperature

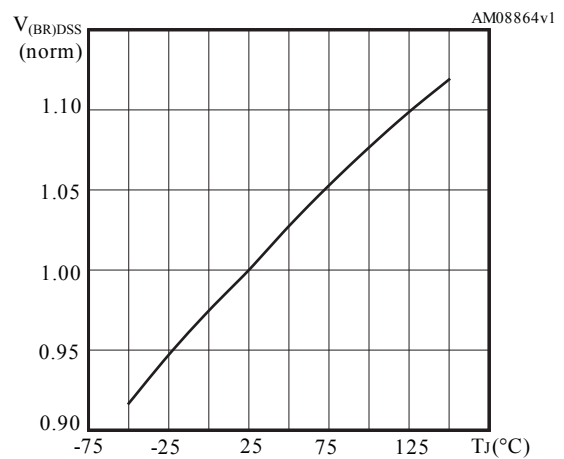
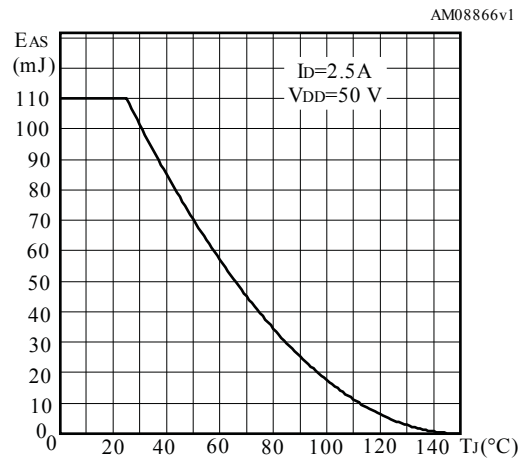
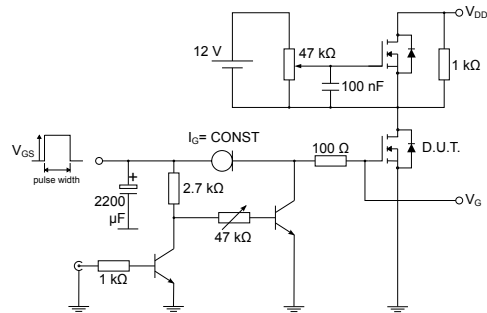

Figure 13. Maximum avalanche energy vs temperature

3 Test circuits

Figure 14. Test circuit for resistive load switching times



AM01468v1

Figure 15. Test circuit for gate charge behavior

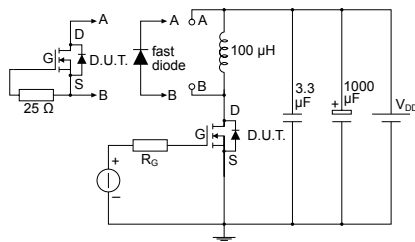
AM01469v1

Figure 16. Test circuit for inductive load switching and diode recovery times

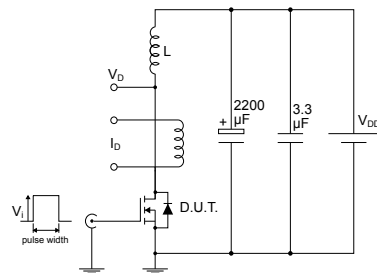
AM01470v1

Figure 17. Unclamped inductive load test circuit

AM01471v1

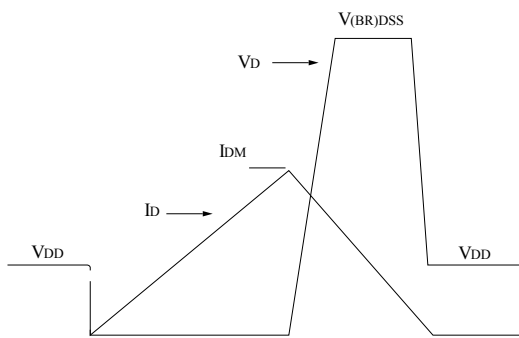
Figure 18. Unclamped inductive waveform

AM01472v1

Figure 19. Switching time waveform



AM01473v1

4 Package information

In order to meet environmental requirements, ST offers these devices in different grades of ECOPACK® packages, depending on their level of environmental compliance. ECOPACK® specifications, grade definitions and product status are available at: www.st.com. ECOPACK® is an ST trademark.

4.1 DPAK (TO-252) type A package information

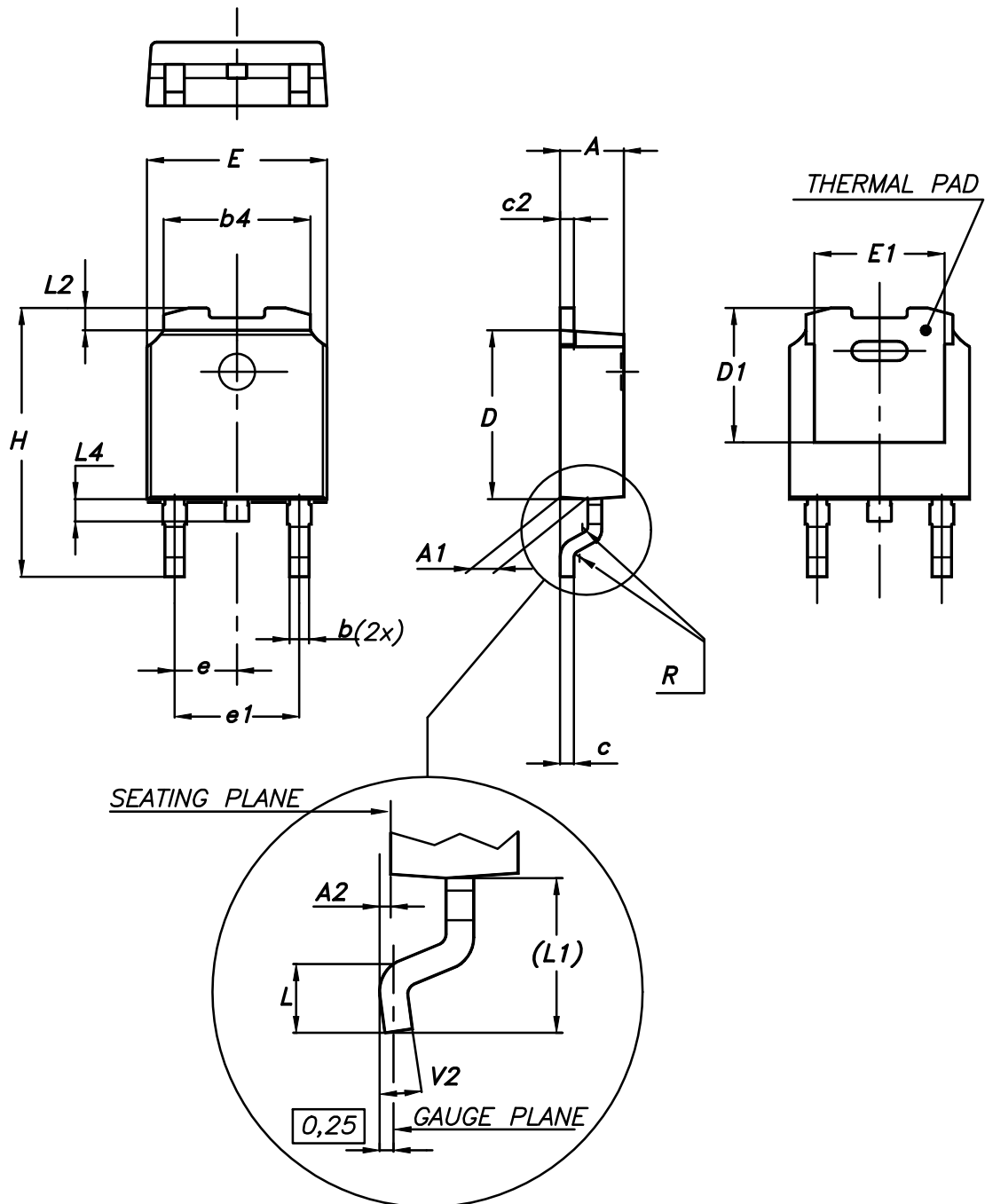
Figure 20. DPAK (TO-252) type A package outline



0068772_A_25

Table 8. DPAK (TO-252) type A mechanical data

Dim.	mm		
	Min.	Typ.	Max.
A	2.20		2.40
A1	0.90		1.10
A2	0.03		0.23
b	0.64		0.90
b4	5.20		5.40
c	0.45		0.60
c2	0.48		0.60
D	6.00		6.20
D1	4.95	5.10	5.25
E	6.40		6.60
E1	4.60	4.70	4.80
e	2.159	2.286	2.413
e1	4.445	4.572	4.699
H	9.35		10.10
L	1.00		1.50
(L1)	2.60	2.80	3.00
L2	0.65	0.80	0.95
L4	0.60		1.00
R		0.20	
V2	0°		8°

4.2 DPAK (TO-252) type E package information

Figure 21. DPAK (TO-252) type E package outline

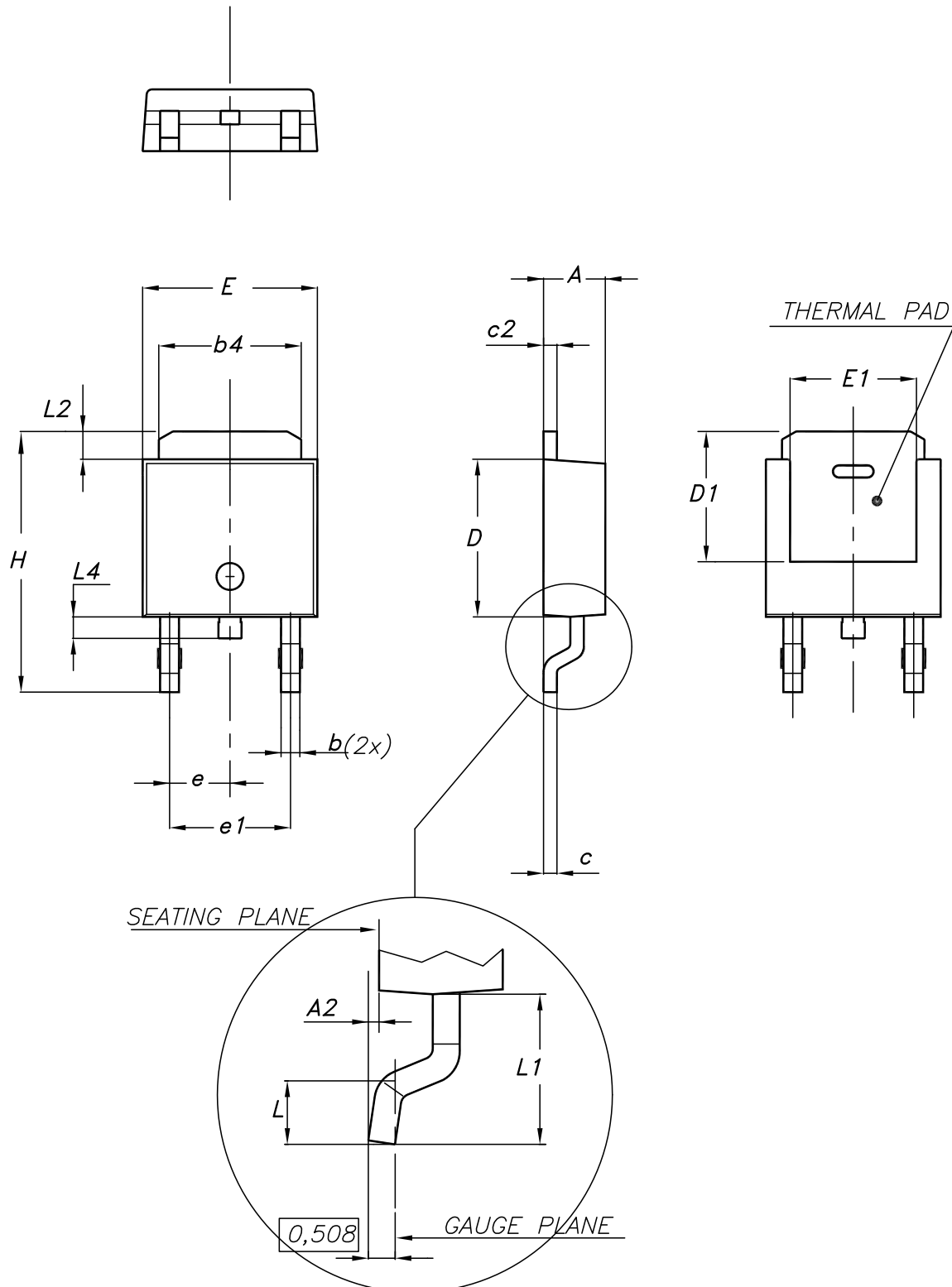
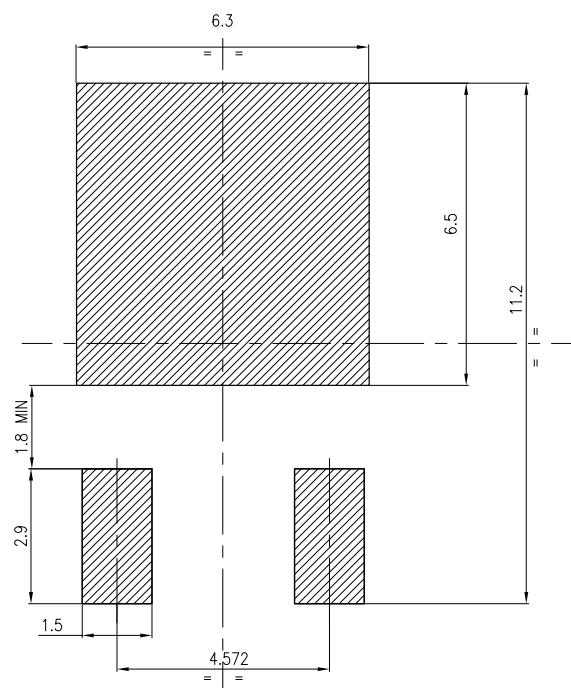

Table 9. DPAK (TO-252) type E mechanical data

Dim.	mm		
	Min.	Typ.	Max.
A	2.18		2.39
A2			0.13
b	0.65		0.884
b4	4.95		5.46
c	0.46		0.61
c2	0.46		0.60
D	5.97		6.22
D1	5.21		
E	6.35		6.73
E1	4.32		
e		2.286	
e1		4.572	
H	9.94		10.34
L	1.50		1.78
L1		2.74	
L2	0.89		1.27
L4			1.02

Figure 22. DPAK (TO-252) recommended footprint (dimensions are in mm)



FP_0068772_25

4.3 DPAK (TO-252) packing information

Figure 23. DPAK (TO-252) tape outline

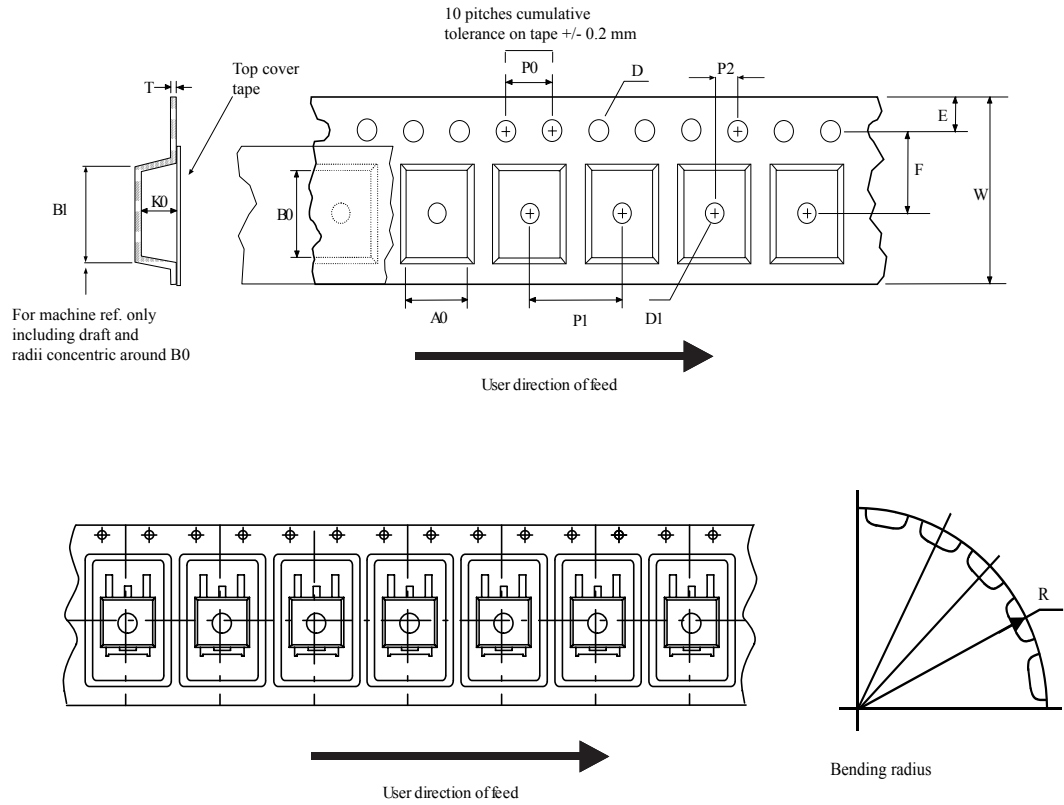

AM08852v1

Figure 24. DPAK (TO-252) reel outline

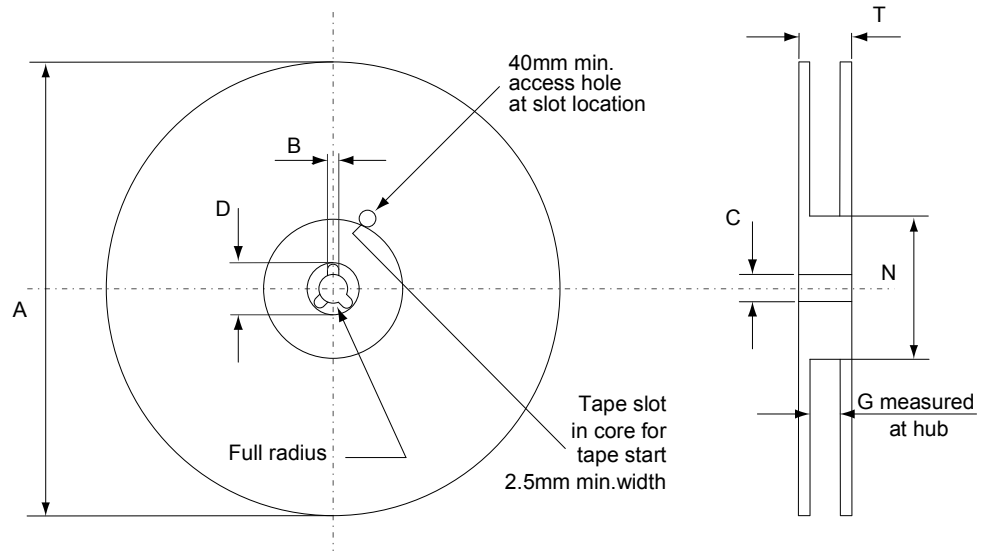

AM06038v1

Table 10. DPAK (TO-252) tape and reel mechanical data

Tape			Reel		
Dim.	mm		Dim.	mm	
	Min.	Max.		Min.	Max.
A0	6.8	7	A		330
B0	10.4	10.6	B	1.5	
B1		12.1	C	12.8	13.2
D	1.5	1.6	D	20.2	
D1	1.5		G	16.4	18.4
E	1.65	1.85	N	50	
F	7.4	7.6	T		22.4
K0	2.55	2.75			
P0	3.9	4.1	Base qty.		2500
P1	7.9	8.1	Bulk qty.		2500
P2	1.9	2.1			
R	40				
T	0.25	0.35			
W	15.7	16.3			

Revision history

Table 11. Document revision history

Date	Revision	Changes
03-Sep-2008	1	Initial release.
21-Feb-2011	2	<ul style="list-style-type: none"> – Added new package, mechanical data: D²PAK; – Added new package, mechanical data: TO-220; – Document status promoted from preliminary data to datasheet.
05-Sep-2018	3	<p>The part numbers STB6N52K3, STF6N52K3 and STP6N52K3 have been moved to a separate datasheet.</p> <p>Removed maturity status indication from cover page. The document status is production data.</p> <p>Updated title and features in cover page.</p> <p>Updated Section 1 Electrical ratings, Section 2 Electrical characteristics and Section 4 Package information.</p> <p>Minor text changes.</p>

Contents

1	Electrical ratings	2
2	Electrical characteristics	3
2.1	Electrical characteristics curves	5
3	Test circuits	8
4	Package information	9
4.1	DPAK (TO-252) type A package information	9
4.2	DPAK (TO-252) type E package information	11
4.3	DPAK (TO-252) packing information	13
	Revision history	16

IMPORTANT NOTICE – PLEASE READ CAREFULLY

STMicroelectronics NV and its subsidiaries (“ST”) reserve the right to make changes, corrections, enhancements, modifications, and improvements to ST products and/or to this document at any time without notice. Purchasers should obtain the latest relevant information on ST products before placing orders. ST products are sold pursuant to ST’s terms and conditions of sale in place at the time of order acknowledgement.

Purchasers are solely responsible for the choice, selection, and use of ST products and ST assumes no liability for application assistance or the design of Purchasers’ products.

No license, express or implied, to any intellectual property right is granted by ST herein.

Resale of ST products with provisions different from the information set forth herein shall void any warranty granted by ST for such product.

ST and the ST logo are trademarks of ST. All other product or service names are the property of their respective owners.

Information in this document supersedes and replaces information previously supplied in any prior versions of this document.

© 2018 STMicroelectronics – All rights reserved

Mouser Electronics

Authorized Distributor

Click to View Pricing, Inventory, Delivery & Lifecycle Information:

[STMicroelectronics:](#)

[STD6N52K3](#)